

Monitoring Relays

1-Phase True RMS AC/DC Over and Under Current

Types DIC01, PIC01



DIC01

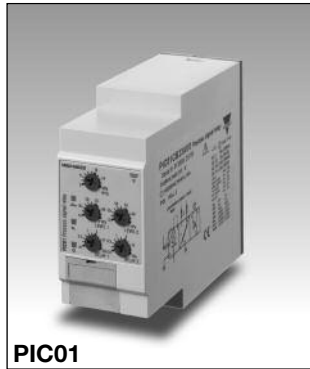

PIC01

- TRMS AC/DC over + under, over+over, under+under current and voltage monitoring relays
- DC process signal plus/minus monitoring relay (DIC01)
- Selection of measuring range by DIP-switches
- Adjustable current and voltage on relative scale
- Adjustable hysteresis on relative scale
- Separately adjustable delay functions (0.1 to 30 s)
- Programmable latching or inhibit at set level
- Output: 1 or 2 x 8 A SPDT relay N.D. or N.E. selectable
- For mounting on DIN-rail in accordance with DIN/EN 50 022 (DIC01) or plug-in module (PIC01)
- 45 mm Euronorm housing (DIC01) or 36 mm plug-in module (PIC01)
- LED indication for relay(s), alarm and power supply ON
- Galvanically separated power supply

Product Description

DIC01 and PIC01 are precise TRMS AC/DC over+under, over+over or under+under current and voltage (selectable by DIP-switch) monitoring relays. DIC01 can perform also DC plus/minus measurement by short circuiting pins Z3 and Y1. The devices can be connected to the MI or MP and A82 or E83 current transformers. Both relays have two individual set levels with their

own time delay. Only for DIC01 each set level can work with a single SPDT relay. Owing to the built-in latch function, the ON-position of the relay output can be maintained. Inhibit function can be used to avoid relay operation when not desired (maintenance, transitions). The LED's indicate the state of the alarm and the output relays.

Ordering Key

DIC 01 D B23 AV0

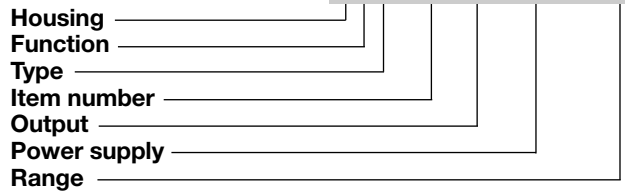

Type Selection

Mounting	Output	Supply: 24 to 48 VAC/DC	Supply: 115/230 VAC
DIN-rail	2xSPDT	DIC 01 D D48 AV0	DIC 01 D B23 AV0
Plug-in	SPDT	PIC 01 C D48 AV0	PIC 01 C B23 AV0

Input Specifications

Input		Measuring voltage ranges	Internal resis.	Max. volt.
Current level	DIC01: Terminals Y1, Y2 PIC01: Terminals 6, 7	Direct		
Voltage level	DIC01: Terminals Y1, Y3 PIC01: Terminals 5, 7	Selectable by DIP-switch		
DC levels (DIC01 only)	Connecting terminals Z3, Y1	0.1 to 1 V AC/DC	> 10 kΩ	7 V
Measuring current ranges		1 to 10 V AC/DC	> 10 kΩ	20 V
		0.4 to 4 V _p AC	> 10 kΩ	100 V
		-1 to 1 VDC } (DIC01 only)	> 10 kΩ	7 V
		-10 to 10 VDC } (DIC01 only)	> 10 kΩ	20 V
		Max. voltage for 1 s		> 10 kΩ
Direct		Max. voltage for 1 s		
Selectable by DIP-switch				
0.5 to 5 mA AC/DC	Internal resis.			
2 to 20 mA AC/DC	Max. curr.			
-5 to 5 mA DC } (DIC01 only)	50 Ω	35 mA		
-20 to 20 mA DC } (DIC01 only)	50 Ω	55 mA		
Max. current for 1 s	50 Ω	35 mA		
	50 Ω	55 mA		
	50 Ω	100 mA		

Note 1:
The input voltage cannot raise over 300 VAC/DC with respect to ground (PIC01 only)

Input Specifications (cont.)

CT ranges	AAC rms	Max. curr.
MI and MP ranges (0.4 to 4 V _p input)		
1-ph.: 3-ph.:		
MI 5 MP 3005	0.5 to 5 A	20 AAC
MI 20 MP 3020	2 to 20 A	50 AAC
MI 100 MP 3100	10 to 100 A	250 AAC
MI 500 MP 3500	50 to 500 A	750 AAC
Note 2: MP 3... current transformers not suitable for under current measurements due to the output signal of the device (see data sheet)		
CT ranges (cont.)	AAC rms	Max. curr.
A82 ranges (2 to 20 mA input)		
A82-10/20 25	2.5 to 25 A	30 AAC
A82-10/20 50	5 to 50 A	60 AAC
A82-10/20 100	10 to 100 A	120 AAC
A82-10/20 250	25 to 250 A	300 AAC
A82-10/20 500	50 to 500 A	600 AAC
E83 ranges (2 to 20 mA input)		
E83-20 50	5 to 50 A	100 AAC
Contact input		
DIC01	Terminals Z1, Y1	
PIC01	Terminals 8, 9	
Disabled	> 10 kΩ	
Enabled	< 500 Ω	
Latch disable	> 500 ms	

Output Specifications

Output	1 or 2 x SPDT relays
Rated insulation voltage	250 VAC
Contact ratings (AgSnO ₂)	μ
Resistive loads AC 1	8 A @ 250 VAC
DC 12	5 A @ 24 VDC
Small inductive loads AC 15	2.5 A @ 250 VAC
DC 13	2.5 A @ 24 VDC
Mechanical life	≥ 30 x 10 ⁶ operations
Electrical life	≥ 10 ⁵ operations (at 8 A, 250 V, cos φ = 1)
Operating frequency	≤ 7200 operations/h
Dielectric strength	
Dielectric voltage	≥ 2 kVAC (rms)
Rated impulse withstand volt.	4 kV (1.2/50 μs)

Supply Specifications

Power supply	Overvoltage cat. III (IEC 60664, IEC 60038)
Rated operational voltage through terminals:	
A1, A2 or A3, A2 (DIC01)	
2, 10 or 11, 10 (PIC01)	
D48:	24 to 48 VAC/DC ± 15% 45 to 65 Hz, insulated
B23:	115/230 VAC ± 15% 45 to 65 Hz, insulated
Dielectric voltage	DC supply AC supply
Supply to input	2 kV 4 kV
Supply to output	4 kV 4 kV
Input to output	4 kV 4 kV
Rated operational power	
AC	5 VA
DC	3 W

General Specifications

Power ON delay	1 s ± 0.5 s or 6 s ± 0.5 s	Housing	
Reaction time	(input signal variation from -20% to +20% or from +20% to -20% of set value)	Dimensions	DIC01 PIC01
Alarm ON delay	< 100 ms	Material	45 x 80 x 99.5 mm 36 x 80 x 94 mm PA66 or Noryl
Alarm OFF delay	< 100 ms	Weight	Approx. 250 g
Accuracy	(15 min warm-up time)	Screw terminals	
Temperature drift	± 1000 ppm/°C	Tightening torque	Max. 0.5 Nm acc. to IEC 60947
Delay ON alarm	± 10% on set value ± 50 ms	Product standard	EN 60255-6
Repeatability	± 0.5% on full-scale	Approvals	UL, CSA
Indication for		CE Marking	L.V. Directive 2006/95/EC EMC Directive 2004/108/EC
Power supply ON	LED, green	EMC	
Alarm ON	LED, red (flashing 2 Hz during delay time)	Immunity	According to EN 60255-26 According to EN 61000-6-2
Output relay ON	1 or 2 x LED(s), yellow	Emissions	According to EN 60255-26 According to EN 61000-6-3
Environment	(EN 60529)		
Degree of protection	IP 20		
Pollution degree	3 (DIC01), 2 (PIC01)		
Operating temperature	-20 to 60°C, R.H. < 95%		
Storage temperature	-30 to 80°C, R.H. < 95%		

Mode of Operation

DIC01 and PIC01 monitor both AC and DC current and voltage. DIC01 can also monitor positive and negative DC voltage connecting terminals Y1 and Z3.

Example 1

(no contact input - under+over voltage - 2 x SPDT N.D. relays (1 x SPDT for PIC01) - TRMS)

DIC01: One relay operates when the voltage drops below the under voltage set point for more than the respective delay time. It releases when the voltage exceeds the set level plus the set hysteresis. The other relay operates when the voltage exceeds the over voltage set point for more than the respective delay time. It releases when the voltage drops below the set level minus hysteresis.

PIC01: The relay operates when the voltage drops below the under voltage set level for more than the respective set delay time or when it exceeds the over voltage set level for more than the relative set delay time. The relay releases when the voltage exceeds the under voltage set level plus hysteresis and it drops

below the over voltage set level minus hysteresis (the hysteresis is the same for both set levels).

Example 2

(latch enable active - under+under current - 2 x SPDT relays (1 x SPDT for PIC01) - TRMS)

DIC01: Each relay operates and latches when the current drops below the respective set level for more than the respective delay time. Provided that the current has exceeded the respective set level plus hysteresis, each relay releases when the contact input's connection is interrupted.

PIC01: The relay operates when the current drops below the higher set level for more than the respective delay time. Provided that the current has exceeded the higher set level plus hysteresis the relay releases when the contact input's connections is interrupted.

Note

Different delay times can be used for appropriate reaction according to the set points.

Example 3

(inhibit enable active - over+over current with MI CT - DPDT relay (SPDT for PIC01) - TRMS)

Provided that the contact input's connection is interrupted, the relay operates when the current flowing in the MI CT exceeds the lower set level for more than the respective delay time. It releases when the current drops below the lower set level minus hysteresis or when the contact input's pins are connected.

Example 4

(inhibit enable active - over+over current with A82-10 CT - DPDT relay (1 x SPDT for PIC01) - TRMS)

Provided that the contact input's connection is interrupted, the relay operates when the current flowing in the A82-10 CT exceeds the lower set level for more than its delay time. It releases when the current drops below the lower set level minus hysteresis or when the contact input's pins are connected.

Example 5 (DIC01 only)

(no contact input - under+over voltage - 2 x SPDT N.D. relays - plus/minus DC)

One relay operates when the voltage drops below the under voltage set point for more than the respective delay time. It releases when the voltage exceeds the set level plus the set hysteresis. The other relay operates when the voltage exceeds the over voltage set point for more than the respective delay time. It releases when the voltage drops below the set level minus hysteresis.

In this case the spare front label has to be placed on the device for proper level adjustment.

Note

When the inhibit contact is opened, if the input signal is already in alarm position, the delay time needs to elapse before relay(s) activation.



Function/Range/Level and Time Delay Setting

Adjust the input range setting the DIP switches 1 and 2 of the main black selector as shown below.

Select the desired function setting the DIP switches 3 to 6 of the black selector and 1, 2 of the small red selector as shown below.

To access the DIP switches open the grey plastic cover as shown below

The selection between current and voltage is automatically selected through the input connectors.

TRMS or positive/negative DC monitoring selectable by short-circuiting terminals Y1 and Z3 (DIC01 only).

Selection of level, time delay and hysteresis:

Upper knob: Setting of hysteresis on relative scale: 0 to 30% on set value.

Centre knobs: Current level setting on relative scale: 10 to 110% on full scale.

Lower knobs: Setting of delay on alarm time on absolute scale (0.1 to 30 s).

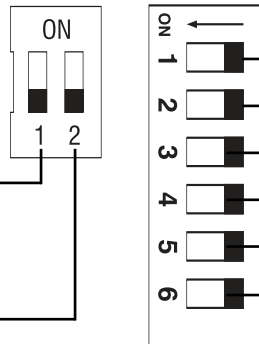
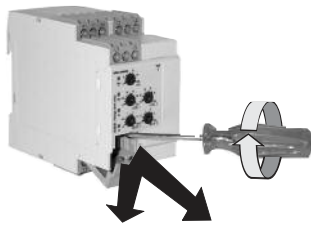

Set Point 2 (SP2) monitoring function
ON: Over current or voltage
OFF: Under current or voltage

Relay(s) coupling
ON: 2 x SPDT (DIC01 only)
OFF: 1 x DPDT (DIC01, PIC01)

Measuring range (depending on connections)		SW1	ON	ON	OFF
Connect	Input term.	SW2	OFF	ON	ON
None	DIC01: Y1,Y2 PIC01: 5,7		0.5 to 5 mA AC/DC	2 to 20 mA AC/DC	None
Y1 to Z3	DIC01: Y1,Y2		-5 to +5 mA DC	-20 to +20 mA DC	None
None	DIC01: Y1,Y3 PIC01: 6,7		0.1 to 1V AC/DC	4 V _p	1 to 10 V AC/DC
Y1 to Z3	DIC01: Y1,Y3		-1 to +1 V DC	None	-10 to +10 V DC

Relay(s) working mode
ON: Normally De-energized (ND)
OFF: Normally Energized (NE)

Power ON delay
ON: 6 s ± 0.5 s
OFF: 1 s ± 0.5 s

Contact input
ON: Latch function enable
OFF: Inhibit function enable

Set Point 1 (SP1) monitoring function
ON: Over current or voltage
OFF: Under current or voltage

Operation Diagrams

Over+over voltage/current - N.D. relay(s)

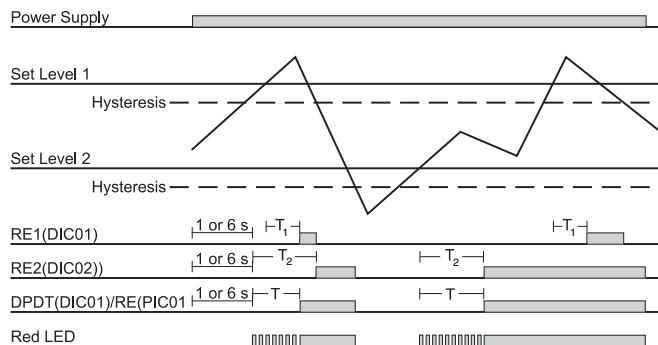

Over+over voltage/current - Latch - N.D. relay(s)

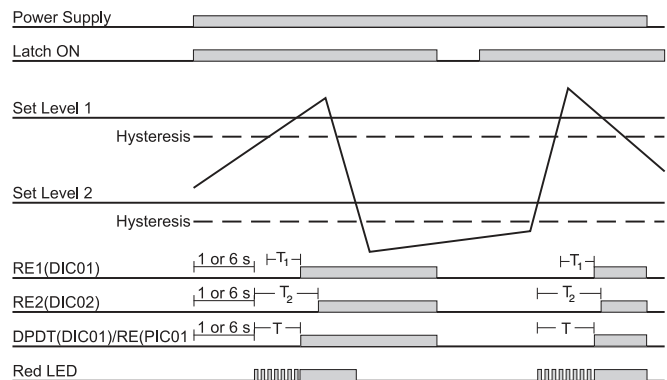

Operation Diagrams (cont.)

Over+under voltage/current - N.E. relay(s)

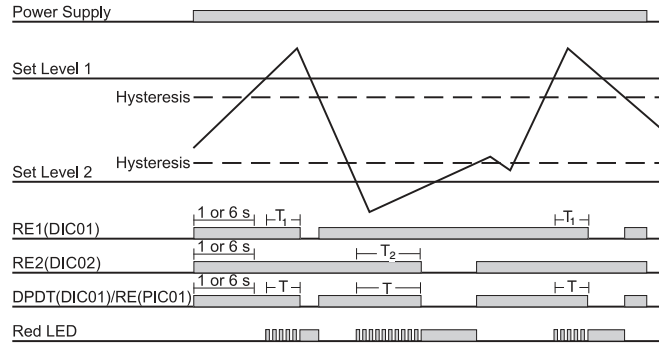

Over+under voltage/current - Inhibit - N.E. relay(s)

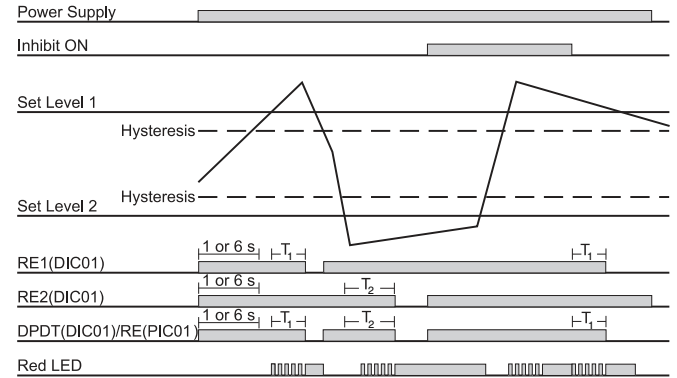

Under+under voltage/current - N.D. relay(s)

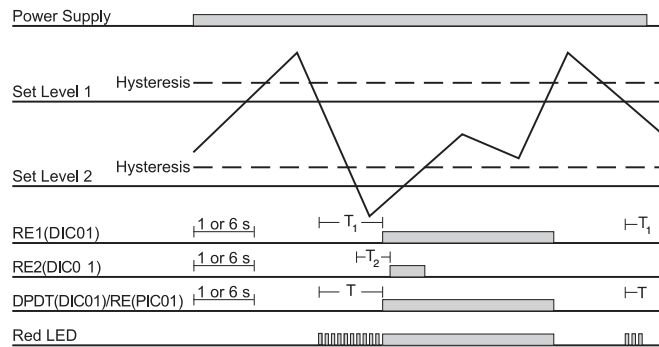

Wiring Diagrams

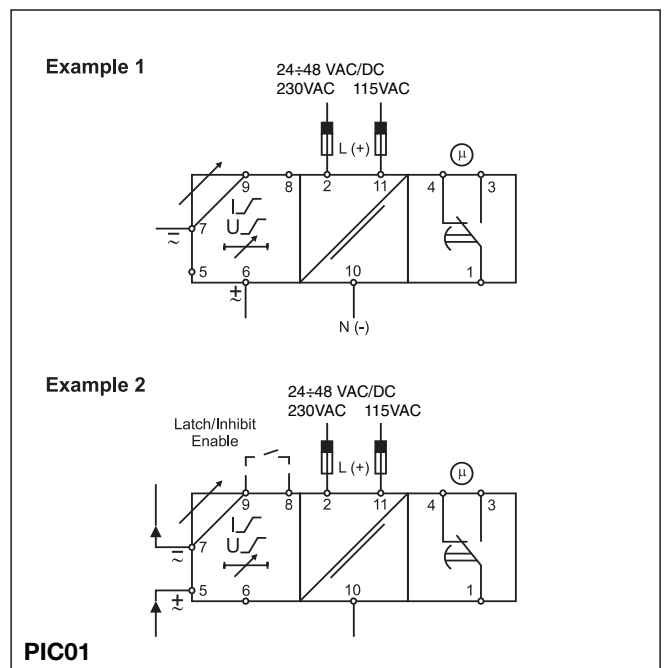
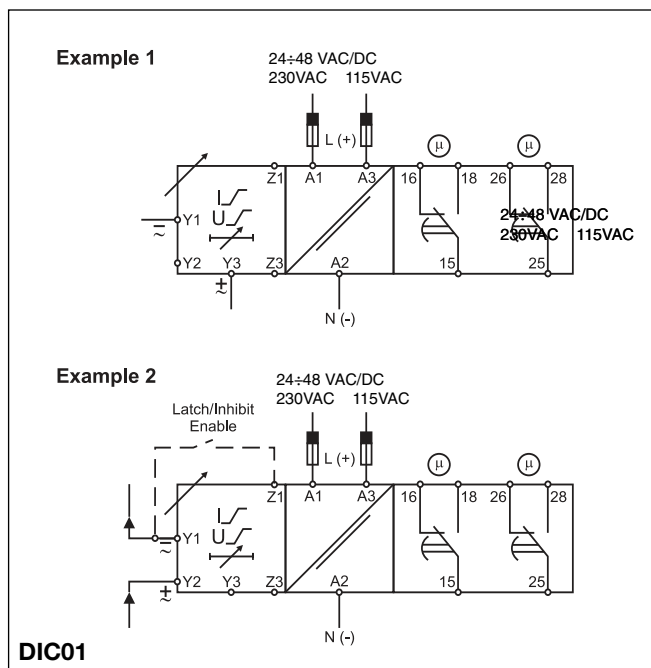

Wiring Diagrams (cont.)

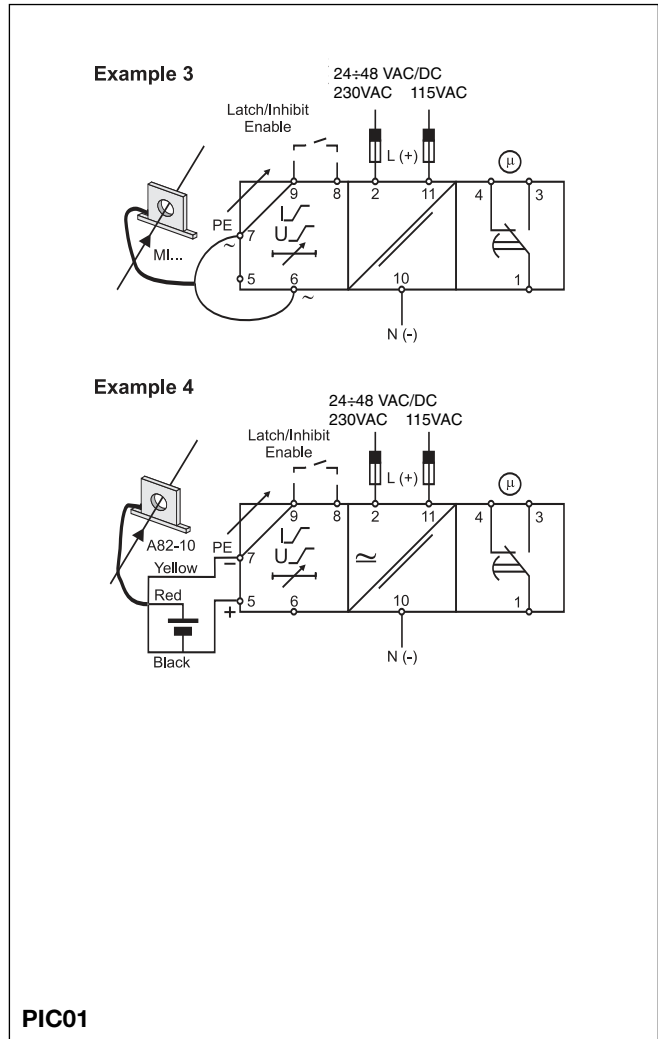
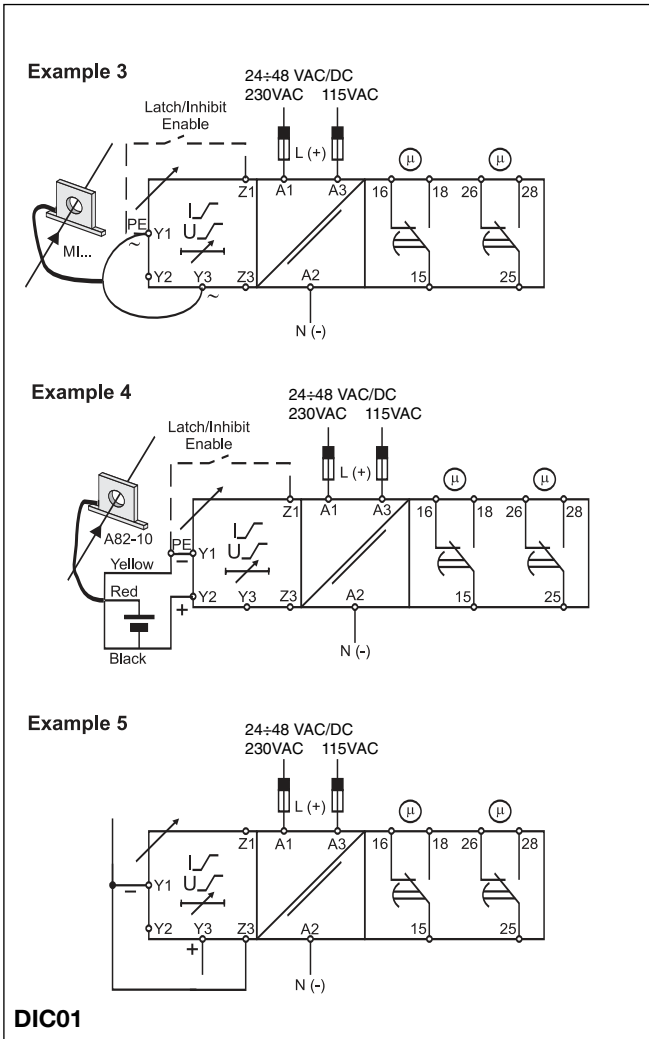

Dimensions

