

NO. OF CKTS.	DIM. A	DIM. B
1	(2.44 ± .15) .096 ± .006	—
2	(4.98 ± .15) .196 ± .006	(2.54 ± .10) .100 ± .004
3	(7.52 ± .15) .296 ± .006	(5.08 ± .10) .200 ± .004
4	(10.06 ± .15) .396 ± .006	(7.62 ± .10) .300 ± .004
5	(12.60 ± .18) .496 ± .007	(10.16 ± .13) .400 ± .005
6	(15.14 ± .18) .596 ± .007	(12.70 ± .13) .500 ± .005
7	(17.68 ± .20) .696 ± .008	(15.24 ± .15) .600 ± .006
8	(20.22 ± .20) .796 ± .008	(17.78 ± .15) .700 ± .006
9	(22.76 ± .20) .896 ± .008	(20.32 ± .15) .800 ± .006
10	(25.30 ± .25) .996 ± .010	(22.86 ± .20) .900 ± .008
11	(27.84 ± .25) 1.096 ± .010	(25.40 ± .20) 1.000 ± .008
12	(30.38 ± .25) 1.196 ± .010	(27.94 ± .20) 1.100 ± .008
13	(32.92 ± .25) 1.296 ± .010	(30.48 ± .20) 1.200 ± .008
14	(35.46 ± .25) 1.396 ± .010	(33.02 ± .20) 1.300 ± .008
15	(38.00 ± .28) 1.496 ± .011	(35.56 ± .23) 1.400 ± .009
16	(40.54 ± .28) 1.596 ± .011	(38.10 ± .23) 1.500 ± .009
17	(43.08 ± .28) 1.696 ± .011	(40.64 ± .23) 1.600 ± .009
18	(45.62 ± .28) 1.796 ± .011	(43.18 ± .23) 1.700 ± .009
19	(48.16 ± .28) 1.896 ± .011	(45.72 ± .23) 1.800 ± .009
20	(50.70 ± .30) 1.996 ± .012	(48.26 ± .25) 1.900 ± .010

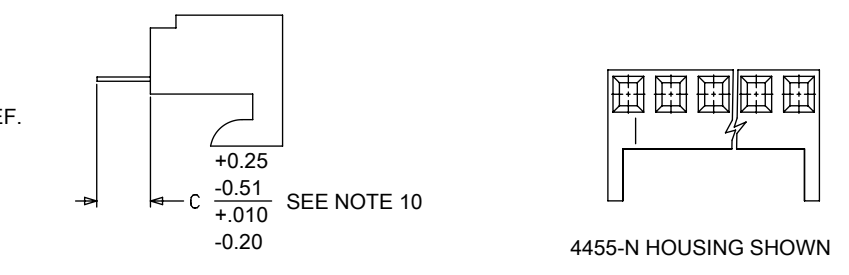

- NOTES:
- MATERIAL: NYLON, UL 94V-0, COLOR: WHITE
  - FINISH:
    - (208) - SELECT GOLD: (0.00038)/.000015 MIN., SELECT TIN: (0.00254)/.000100 MIN. OVERALL NICKEL UNDERPLATE: (0.00127)/.000050 MIN.
    - (228) - SELECT GOLD: (0.00076)/.000030 MIN., SELECT TIN: (0.00254)/.000100 MIN. OVERALL NICKEL UNDERPLATE: (0.00127)/.000050 MIN.
    - (231) - SELECT GOLD: (0.00127)/.000050 MIN., SELECT TIN: (0.00254)/.000100 MIN. OVERALL NICKEL UNDERPLATE: (0.00127)/.000050 MIN.
    - (565) - SELECT GOLD: (0.00051)/.000020 MIN., OVERALL NICKEL: (0.00076)/.000030 MIN. OVERALL GOLD FLASH: (0.00005)/.000002 MIN.
    - (P909) - OVERALL TIN: (0.00254)/.000100 MIN.
  - PARTS CONFORM TO PRODUCT SPECIFICATION PS-10-07.
  - PACKAGING: SEE CHARTS.
  - PARTS MUST CONFORM TO SOLDERABILITY SPEC 152.
  - PARTS ARE STACKABLE END TO END ON (2.54)/.100 CENTERS.
  - TYPICAL PCB THICKNESS: (1.57)/.062
  - PART CONFORMS TO CLASS B REQUIREMENTS OF COSMETIC SPECIFICATION PS-45499-002 EXCEPT PROTRUSIONS. PARTS MAY HAVE MORE THAN 2 GATE MARKS.
  - WHEN MATING ASSEMBLIES THAT USE 4455-BN HOUSINGS TO BREAKAWAY FRICTION LOCK OR POLARIZING HEADERS, THE END BACKWALLS MUST BE REMOVED.
  - DIMENSION C MEASURED WITH TERMINAL PUSHED IN AGAINST THE STOP.

DOCUMENT STATUS	P1	RELEASE DATE	2022/07/29	12:32:02
-----------------	----	--------------	------------	----------

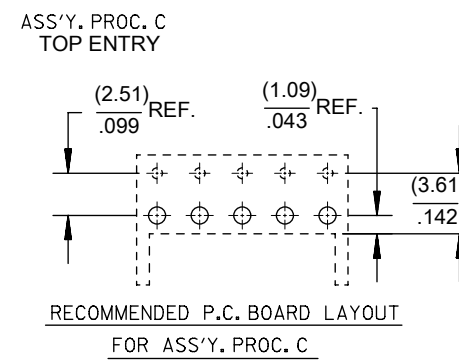
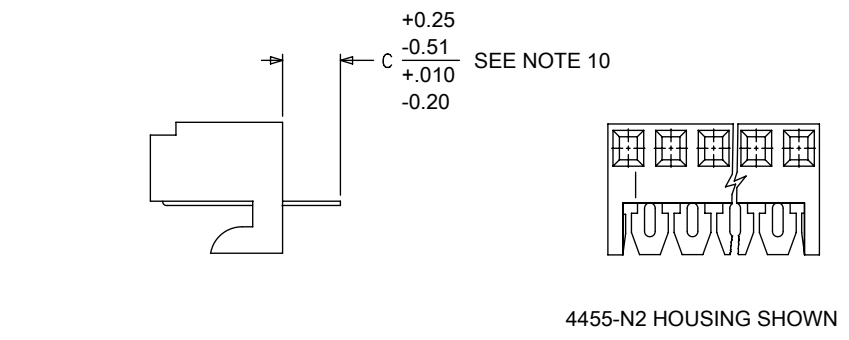
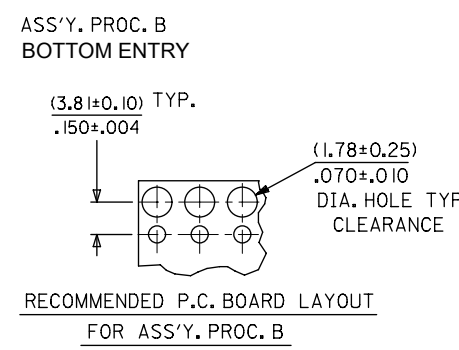
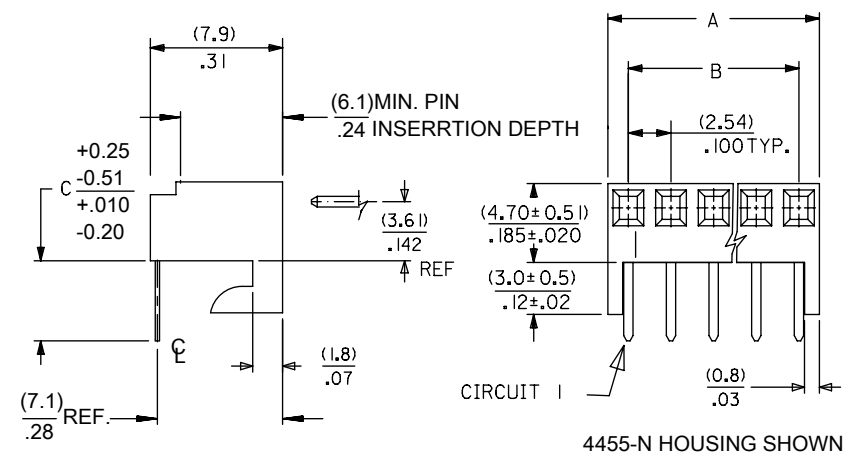
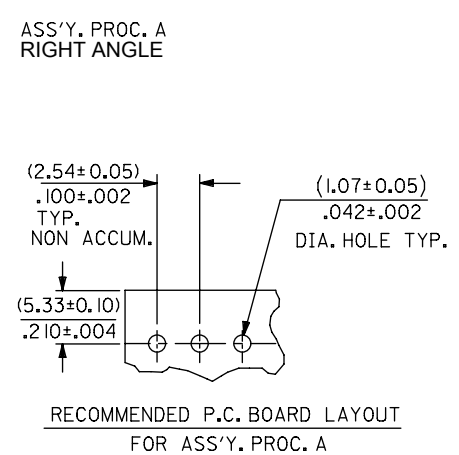
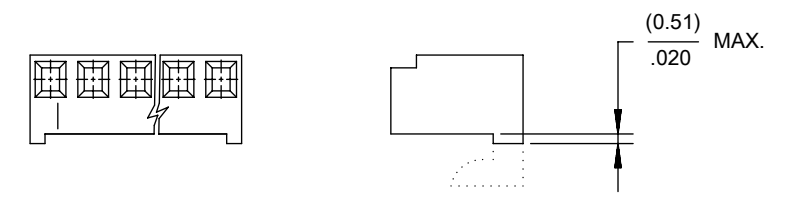
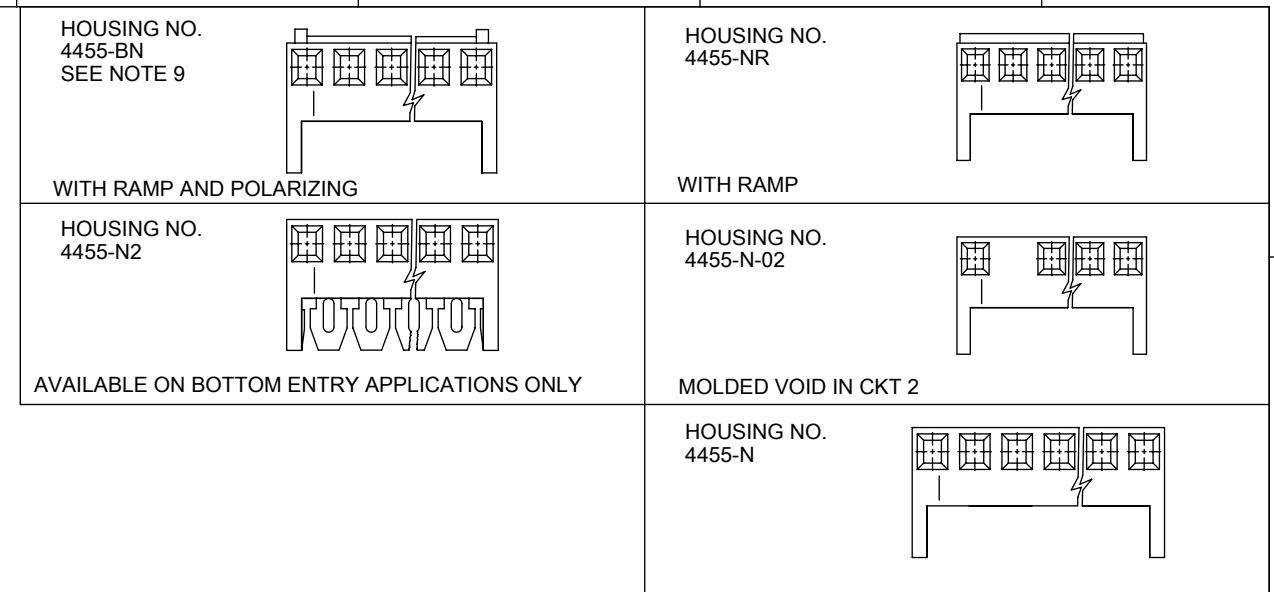

HOOKS CUT OPTION AVAILABLE ON TOP ENTRY, SEE CHART

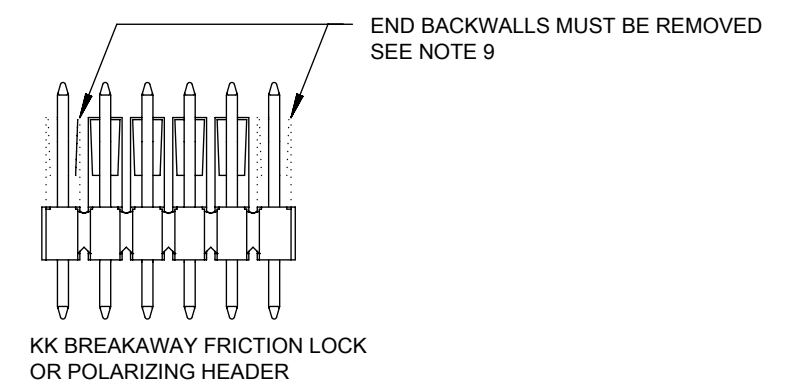

THIS DRAWING CONTAINS INFORMATION THAT IS PROPRIETARY TO MOLEX ELECTRONIC TECHNOLOGIES, LLC AND SHOULD NOT BE USED WITHOUT WRITTEN PERMISSION

DIMENSION UNITS	SCALE	CURRENT REV DESC: REMOVED OBSOLETE PART NUMBER AS PER PCN#512128.	
MM/IN	1:1		
GENERAL TOLERANCES (UNLESS SPECIFIED)			
	MM	INCH	
4 PLACES	±	±	
3 PLACES	±	± 0.01	
2 PLACES	± 0.25	± 0.015	
1 PLACE	± 0.36	±	
0 PLACES	±	±	
ANGULAR TOL	± 0.5°		
DRAFT WHERE APPLICABLE MUST REMAIN WITHIN DIMENSIONS		THIRD ANGLE PROJECTION	DRAWING
		B-SIZE	SERIES
		4455	MATERIAL NUMBER
		SEE CHART	CUSTOMER
		GENERAL MARKET	SHEET NUMBER
		1 OF 15	

EC NO: 716046  
DRWN: SANTHN  
CHKD: GGA  
APPR: GGA

2022/07/22  
2022/07/29  
2022/07/29

INITIAL REVISION:  
DRWN: SAMIEC  
APPR: LENZ

1984/05/10  
1984/05/10

DOCUMENT NUMBER: SDA-4455  
DOC TYPE: PSD  
DOC PART: 001  
REVISION: D18

PRODUCT CUSTOMER DRAWING

KK 100 PCB ASSY  
4455 SERIES DWG

# KK 100 PCB ASSY 2-25 CKT 4455 SERIES

A-4455- \* \* N \* \* - \*

ASSY PROCEDURE  
 A=RIGHT ANGLE  
 B=BOTTOM ENTRY  
 C=TOP ENTRY

HOUSING OPTION

- A=4455-AN
- B=4455-BN
- E=4455-NHH
- G=4455-BN (HOOKS CUT OFF)
- H=4455-N2 (BOTTOM ENTRY ONLY)
- P=4455-NR (HOOKS CUT OFF)
- R=4455-NR
- V=4455-N-02
- W=4455-N-02 (HOOKS CUT OFF)
- Y=4455-N (HOOKS CUT OFF)
- Z=4455-N

NO OF CIRCUITS

TERMINAL TYPE

Code	Number	Material	Form
A	4316-4	Brass	Standard
B	6516-4	Phos Bronze	Standard
C	6516-5C	Phos Bronze	Cat Ear / V
D	4316-3B	Brass	Std / V
F	6516-6C	Phos Bronze	Cat Ear / V
G	4316-3	Brass	Standard
J	6516-3B	Phos Bronze	Std / V
L	6516-3C	Phos Bronze	Cat Ear / V
M	6516-4A	Phos Bronze	Cat Ear
T	4316-4A	Brass	Cat Ear

PLATING

(SEE SHEET 1)

VOID LOCATION  
 NUMBER = CIRCUIT VOIDED  
 MULTIPLE VOIDS START  
 WITH 51  
 BLANK = NONE

Ckts	Assy Proc:	RIGHT ANGLE	Assy Proc:	RIGHT ANGLE
		Hooks Cut:	NO	Hooks Cut:
	Housing No:	4455-N	Housing No:	4455-N
	Terminal No:	4316-4(P909)	Terminal No:	4316-4(565)
	Dim C:	3.35 / .132	Dim C:	3.35 / .132
	Plating:	P909	Plating:	565
	Packaging:	PK-44646-001	Packaging:	PK-44646-001
	Voids:	NONE	Voids:	NONE
Material No	Engineer Number	Material No	Engineer Number	
2	22-15-2026	A-4455-AZ02A(P909)	22-16-2021	A-4455-AZ02A(565)
3	22-15-2036	A-4455-AZ03A(P909)	22-16-2031	A-4455-AZ03A(565)
4	22-15-2046	A-4455-AZ04A(P909)	22-16-2041	A-4455-AZ04A(565)
5	22-15-2056	A-4455-AZ05A(P909)	22-16-2051	A-4455-AZ05A(565)
6	22-15-2066	A-4455-AZ06A(P909)	22-16-2061	A-4455-AZ06A(565)
7	22-15-2076	A-4455-AZ07A(P909)	22-16-2071	A-4455-AZ07A(565)
8	22-15-2086	A-4455-AZ08A(P909)	22-16-2081	A-4455-AZ08A(565)
9	22-15-2096	A-4455-AZ09A(P909)	22-16-2091	A-4455-AZ09A(565)
10	22-15-2106	A-4455-AZ10A(P909)	22-16-2101	A-4455-AZ10A(565)
11	22-15-2116	A-4455-AZ11A(P909)	22-16-2111	A-4455-AZ11A(565)
12	22-15-2126	A-4455-AZ12A(P909)	22-16-2121	A-4455-AZ12A(565)
13	22-15-2136	A-4455-AZ13A(P909)	22-16-2131	A-4455-AZ13A(565)
14	22-15-2146	A-4455-AZ14A(P909)	22-16-2141	A-4455-AZ14A(565)
15	22-15-2156	A-4455-AZ15A(P909)	22-16-2151	A-4455-AZ15A(565)
16	22-15-2166	A-4455-AZ16A(P909)	22-16-2161	A-4455-AZ16A(565)
17	22-15-2176	A-4455-AZ17A(P909)	22-16-2171	A-4455-AZ17A(565)
18	22-15-2186	A-4455-AZ18A(P909)	22-16-2181	A-4455-AZ18A(565)
19	22-15-2196	A-4455-AZ19A(P909)	22-16-2191	A-4455-AZ19A(565)
20	22-15-2206	A-4455-AZ20A(P909)	22-16-2201	A-4455-AZ20A(565)
21				
22				
23				
24				
25				

THIS DRAWING CONTAINS INFORMATION THAT IS PROPRIETARY TO MOLEX ELECTRONIC TECHNOLOGIES, LLC AND SHOULD NOT BE USED WITHOUT WRITTEN PERMISSION													
DIMENSION UNITS	SCALE	CURRENT REV DESC: REMOVED OBSOLETE PART NUMBER AS PER PCN#512128.					molex						
MM/IN	1:1	EC NO: 716046 DRWN: SANTHN 2022/07/22 CHKD: GGA 2022/07/29 APPR: GGA 2022/07/29 INITIAL REVISION: DRWN: SAMIEC 1984/05/10 APPR: LENZ 1984/05/10					KK 100 PCB ASSY 4455 SERIES DWG						
GENERAL TOLERANCES (UNLESS SPECIFIED)							PRODUCT CUSTOMER DRAWING						
4 PLACES ±	MM						INCH	DOCUMENT NUMBER			DOC TYPE	DOC PART	REVISION
3 PLACES ±	0.25						0.015	SDA-4455			PSD	001	D18
2 PLACES ±	0.36						0.015	MATERIAL NUMBER			CUSTOMER		
1 PLACE ±	0.5°	0.5°	SEE CHART			GENERAL MARKET							
ANGULAR TOL ±		THIRD ANGLE PROJECTION		DRAWING	SERIES	SHEET NUMBER							
DRAFT WHERE APPLICABLE MUST REMAIN WITHIN DIMENSIONS				B-SIZE	4455	2 OF 15							

# KK 100 PCB ASSY 2-25 CKT 4455 SERIES

STANDARD PRODUCT

Ckts	Assy Proc: RIGHT ANGLE		Assy Proc: BOTTOM ENTRY		Assy Proc: BOTTOM ENTRY		Assy Proc: BOTTOM ENTRY	
	Material No	Engineer Number	Material No	Engineer Number	Material No	Engineer Number	Material No	Engineer Number
2	22-16-2020	A-4455-AZ02A(208)	22-14-2024	A-4455-BH02D(P909)	22-17-2022	A-4455-BH02D(565)	22-17-3022	A-4455-BH02D(208)
3	22-16-2030	A-4455-AZ 03 A(208)	22-14-2034	A-4455-BH 03 D(P909)	22-17-2032	A-4455-BH 03 D(565)	22-17-3032	A-4455-BH 03 D(208)
4	22-16-2040	A-4455-AZ 04 A(208)	22-14-2044	A-4455-BH 04 D(P909)	22-17-2042	A-4455-BH 04 D(565)	22-17-3042	A-4455-BH 04 D(208)
5	22-16-2050	A-4455-AZ 05 A(208)	22-14-2054	A-4455-BH 05 D(P909)	22-17-2052	A-4455-BH 05 D(565)	22-17-3052	A-4455-BH 05 D(208)
6	22-16-2060	A-4455-AZ 06 A(208)	22-14-2064	A-4455-BH 06 D(P909)	22-17-2062	A-4455-BH 06 D(565)	22-17-3062	A-4455-BH 06 D(208)
7	22-16-2070	A-4455-AZ 07 A(208)	22-14-2074	A-4455-BH 07 D(P909)	22-17-2072	A-4455-BH 07 D(565)	22-17-3072	A-4455-BH 07 D(208)
8	22-16-2080	A-4455-AZ 08 A(208)	22-14-2084	A-4455-BH 08 D(P909)	22-17-2082	A-4455-BH 08 D(565)	22-17-3082	A-4455-BH 08 D(208)
9	22-16-2090	A-4455-AZ 09 A(208)	22-14-2094	A-4455-BH 09 D(P909)	22-17-2092	A-4455-BH 09 D(565)	22-17-3092	A-4455-BH 09 D(208)
10	22-16-2100	A-4455-AZ 10 A(208)	22-14-2104	A-4455-BH 10 D(P909)	22-17-2102	A-4455-BH 10 D(565)	22-17-3102	A-4455-BH 10 D(208)
11	22-16-2110	A-4455-AZ 11 A(208)	22-14-2114	A-4455-BH 11 D(P909)	22-17-2112	A-4455-BH 11 D(565)	22-17-3112	A-4455-BH 11 D(208)
12	22-16-2120	A-4455-AZ 12 A(208)	22-14-2124	A-4455-BH 12 D(P909)	22-17-2122	A-4455-BH 12 D(565)	22-17-3122	A-4455-BH 12 D(208)
13	22-16-2130	A-4455-AZ 13 A(208)	22-14-2134	A-4455-BH 13 D(P909)	22-17-2132	A-4455-BH 13 D(565)	22-17-3132	A-4455-BH 13 D(208)
14	22-16-2140	A-4455-AZ 14 A(208)	22-14-2144	A-4455-BH 14 D(P909)	22-17-2142	A-4455-BH 14 D(565)	22-17-3142	A-4455-BH 14 D(208)
15	22-16-2150	A-4455-AZ 15 A(208)	22-14-2154	A-4455-BH 15 D(P909)	22-17-2152	A-4455-BH 15 D(565)	22-17-3152	A-4455-BH 15 D(208)
16	22-16-2160	A-4455-AZ 16 A(208)	22-14-2164	A-4455-BH 16 D(P909)	22-17-2162	A-4455-BH 16 D(565)	22-17-3162	A-4455-BH 16 D(208)
17	22-16-2170	A-4455-AZ 17 A(208)	22-14-2174	A-4455-BH 17 D(P909)	22-17-2172	A-4455-BH 17 D(565)	22-17-3172	A-4455-BH 17 D(208)
18	22-16-2180	A-4455-AZ 18 A(208)	22-14-2184	A-4455-BH 18 D(P909)			22-17-3182	A-4455-BH 18 D(208)
19	22-16-2190	A-4455-AZ 19 A(208)	22-14-2194	A-4455-BH 19 D(P909)			22-17-3192	A-4455-BH 19 D(208)
20	22-16-2200	A-4455-AZ 20 A(208)	22-14-2204	A-4455-BH 20 D(P909)	22-17-2202	A-4455-BH 20 D(565)	22-17-3202	A-4455-BH 20 D(208)
21								
22								
23	22-16-2230	A-4455-AZ 23 A(208)						
24								
25								

THIS DRAWING CONTAINS INFORMATION THAT IS PROPRIETARY TO MOLEX ELECTRONIC TECHNOLOGIES, LLC AND SHOULD NOT BE USED WITHOUT WRITTEN PERMISSION											
DIMENSION UNITS <b>MM/IN</b>	SCALE <b>1:1</b>	CURRENT REV DESC: REMOVED OBSOLETE PART NUMBER AS PER PCN#512128.					molex				
GENERAL TOLERANCES (UNLESS SPECIFIED)		EC NO: 716046 DRWN: SANTHN CHKD: GGA APPR: GGA					KK 100 PCB ASSY 4455 SERIES DWG				
		2022/07/22 2022/07/29 2022/07/29					PRODUCT CUSTOMER DRAWING				
		INITIAL REVISION: DRWN: SAMIEC APPR: LENZ					DOCUMENT NUMBER <b>SDA-4455</b>		DOC TYPE <b>PSD</b>	DOC PART <b>001</b>	REVISION <b>D18</b>
		ANGULAR TOL ± 0.5°	THIRD ANGLE PROJECTION 	DRAWING <b>B-SIZE</b>	SERIES <b>4455</b>	MATERIAL NUMBER SEE CHART	CUSTOMER GENERAL MARKET		SHEET NUMBER 3 OF 15		

# KK 100 PCB ASSY 2-25 CKT

## 4455 SERIES

Ckts	Assy Proc: TOP ENTRY		Assy Proc: TOP ENTRY		Assy Proc: TOP ENTRY		Assy Proc: RIGHT ANGLE	
	Material No	Engineer Number	Material No	Engineer Number	Material No	Engineer Number	Material No	Engineer Number
2	22-02-2025	A-4455-CZ02A(P909)	22-18-2023	A-4455-CZ02A(565)	22-18-2021	A-4455-CZ02A(208)	22-15-4025	A-4455-AZ02B(P909)
3	22-02-2035	A-4455-CZ 03A(P909)	22-18-2033	A-4455-CZ 03 A(565)	22-18-2031	A-4455-CZ 03 A(208)	22-15-4035	A-4455-AZ 03B(P909)
4	22-02-2045	A-4455-CZ 04A(P909)	22-18-2043	A-4455-CZ 04 A(565)	22-18-2041	A-4455-CZ 04 A(208)	22-15-4045	A-4455-AZ 04B(P909)
5	22-02-2055	A-4455-CZ 05A(P909)	22-18-2053	A-4455-CZ 05 A(565)	22-18-2051	A-4455-CZ 05 A(208)	22-15-4055	A-4455-AZ 05B(P909)
6	22-02-2065	A-4455-CZ 06A(P909)	22-18-2063	A-4455-CZ 06 A(565)	22-18-2061	A-4455-CZ 06 A(208)	22-15-4065	A-4455-AZ 06B(P909)
7	22-02-2075	A-4455-CZ 07A(P909)	22-18-2073	A-4455-CZ 07 A(565)	22-18-2071	A-4455-CZ 07 A(208)	22-15-4075	A-4455-AZ 07B(P909)
8	22-02-2085	A-4455-CZ 08 A(P909)	22-18-2083	A-4455-CZ 08 A(565)	22-18-2081	A-4455-CZ 08 A(208)	22-15-4085	A-4455-AZ 08B(P909)
9	22-02-2095	A-4455-CZ 09 A(P909)	22-18-2093	A-4455-CZ 09 A(565)	22-18-2091	A-4455-CZ 09 A(208)	22-15-4095	A-4455-AZ 09B(P909)
10	22-02-2105	A-4455-CZ 10 A(P909)	22-18-2103	A-4455-CZ 10 A(565)	22-18-2101	A-4455-CZ 10 A(208)	22-15-4105	A-4455-AZ 10B(P909)
11	22-02-2115	A-4455-CZ 11 A(P909)	22-18-2113	A-4455-CZ 11 A(565)	22-18-2111	A-4455-CZ 11 A(208)	22-15-4115	A-4455-AZ 11B(P909)
12	22-02-2125	A-4455-CZ 12 A(P909)	22-18-2123	A-4455-CZ 12 A(565)	22-18-2121	A-4455-CZ 12 A(208)	22-15-4125	A-4455-AZ 12B(P909)
13	22-02-2135	A-4455-CZ 13 A(P909)	22-18-2133	A-4455-CZ 13 A(565)	22-18-2131	A-4455-CZ 13 A(208)	22-15-4135	A-4455-AZ 13B(P909)
14	22-02-2145	A-4455-CZ 14 A(P909)	22-18-2143	A-4455-CZ 14 A(565)	22-18-2141	A-4455-CZ 14 A(208)	22-15-4145	A-4455-AZ 14B(P909)
15	22-02-2155	A-4455-CZ 15 A(P909)			22-18-2151	A-4455-CZ 15 A(208)	22-15-4155	A-4455-AZ 15B(P909)
16	22-02-2165	A-4455-CZ 16 A(P909)			22-18-2161	A-4455-CZ 16 A(208)	22-15-4165	A-4455-AZ 16B(P909)
17	22-02-2175	A-4455-CZ 17 A(P909)			22-18-2171	A-4455-CZ 17 A(208)	22-15-4175	A-4455-AZ 17B(P909)
18	22-02-2185	A-4455-CZ 18 A(P909)	22-18-2183	A-4455-CZ 18 A(565)	22-18-2181	A-4455-CZ 18 A(208)	22-15-4185	A-4455-AZ 18B(P909)
19	22-02-2195	A-4455-CZ 19 A(P909)			22-18-2191	A-4455-CZ 19 A(208)	22-15-4195	A-4455-AZ 19B(P909)
20	22-02-2205	A-4455-CZ 20 A(P909)	22-18-2203	A-4455-CZ 20 A(565)	22-18-2201	A-4455-CZ 20 A(208)	22-15-4205	A-4455-AZ 20B(P909)
21							22-15-4215	A-4455-AZ 21B(P909)
22							22-15-4225	A-4455-AZ 22B(P909)
23							22-15-4235	A-4455-AZ 23B(P909)
24							22-15-4245	A-4455-AZ 24B(P909)
25							22-15-4255	A-4455-AZ 25B(P909)

THIS DRAWING CONTAINS INFORMATION THAT IS PROPRIETARY TO MOLEX ELECTRONIC TECHNOLOGIES, LLC AND SHOULD NOT BE USED WITHOUT WRITTEN PERMISSION												
DIMENSION UNITS <b>MM/IN</b>		SCALE <b>1:1</b>		CURRENT REV DESC: REMOVED OBSOLETE PART NUMBER AS PER PCN#512128.				molex				
GENERAL TOLERANCES (UNLESS SPECIFIED)						EC NO: 716046		KK 100 PCB ASSY 4455 SERIES DWG				
4 PLACES ± 0.25 ± 0.015						DRWN: SANTHN 2022/07/22						
3 PLACES ± 0.25 ± 0.015						CHKD: GGA 2022/07/29		PRODUCT CUSTOMER DRAWING				
2 PLACES ± 0.25 ± 0.015						APPR: GGA 2022/07/29		DOCUMENT NUMBER				
1 PLACE ± 0.36 ± 0.015						INITIAL REVISION:		SDA-4455		DOC TYPE	DOC PART	REVISION
0 PLACES ± 0.36 ± 0.015						DRWN: SAMIEC 1984/05/10		PSD		001	D18	
ANGULAR TOL ± 0.5°						APPR: LENZ 1984/05/10		MATERIAL NUMBER		CUSTOMER		SHEET NUMBER
DRAFT WHERE APPLICABLE MUST REMAIN WITHIN DIMENSIONS						THIRD ANGLE PROJECTION		DRAWING	SERIES	SEE CHART		GENERAL MARKET
								B-SIZE	4455	4 OF 15		

# KK 100 PCB ASSY 2-25 CKT

## 4455 SERIES

Ckts	Assy Proc: RIGHT ANGLE		Assy Proc: RIGHT ANGLE		Assy Proc: BOTTOM ENTRY		Assy Proc: BOTTOM ENTRY	
	Material No	Engineer Number	Material No	Engineer Number	Material No	Engineer Number	Material No	Engineer Number
2	22-16-2024	A-4455-AZ02B(565)			22-17-2021	A-4455-BH02J(565)		
3	22-16-2034	A-4455-AZ 03 B(565)			22-17-2031	A-4455-BH 03 J(565)		
4	22-16-2044	A-4455-AZ 04 B(565)			22-17-2041	A-4455-BH 04 J(565)		
5	22-16-2054	A-4455-AZ 05 B(565)			22-17-2051	A-4455-BH 05 J(565)		
6	22-16-2064	A-4455-AZ 06 B(565)			22-17-2061	A-4455-BH 06 J(565)		
7	22-16-2074	A-4455-AZ 07 B(565)			22-17-2071	A-4455-BH 07 J(565)		
8	22-16-2084	A-4455-AZ 08 B(565)			22-17-2081	A-4455-BH 08 J(565)		
9	22-16-2094	A-4455-AZ 09 B(565)			22-17-2091	A-4455-BH 09 J(565)		
10	22-16-2104	A-4455-AZ 10 B(565)			22-17-2101	A-4455-BH 10 J(565)		
11	22-16-2114	A-4455-AZ 11 B(565)			22-17-2111	A-4455-BH 11 J(565)		
12	22-16-2124	A-4455-AZ 12 B(565)			22-17-2121	A-4455-BH 12 J(565)		
13	22-16-2134	A-4455-AZ 13 B(565)			22-17-2131	A-4455-BH 13 J(565)		
14	22-16-2144	A-4455-AZ 14 B(565)			22-17-2141	A-4455-BH 14 J(565)		
15	22-16-2154	A-4455-AZ 15 B(565)			22-17-2151	A-4455-BH 15 J(565)		
16	22-16-2164	A-4455-AZ 16 B(565)			22-17-2161	A-4455-BH 16 J(565)		
17	22-16-2174	A-4455-AZ 17 B(565)			22-17-2171	A-4455-BH 17 J(565)		
18	22-16-2184	A-4455-AZ 18 B(565)			22-17-2181	A-4455-BH 18 J(565)		
19	22-16-2194	A-4455-AZ 19 B(565)			22-17-2191	A-4455-BH 19 J(565)		
20	22-16-2204	A-4455-AZ 20 B(565)			22-17-2201	A-4455-BH 20 J(565)		
21	22-16-2214	A-4455-AZ 21 B(565)			22-17-2211	A-4455-BH 21 J(565)		
22	22-16-2224	A-4455-AZ 22 B(565)			22-17-2221	A-4455-BH 22 J(565)		
23	22-16-2234	A-4455-AZ 23 B(565)			22-17-2231	A-4455-BH 23 J(565)		
24	22-16-2244	A-4455-AZ 24 B(565)			22-17-2241	A-4455-BH 24 J(565)		
25					22-17-2251	A-4455-BH 25 J(565)		

THIS DRAWING CONTAINS INFORMATION THAT IS PROPRIETARY TO MOLEX ELECTRONIC TECHNOLOGIES, LLC AND SHOULD NOT BE USED WITHOUT WRITTEN PERMISSION												
DIMENSION UNITS <b>MM/IN</b>		SCALE <b>1:1</b>		CURRENT REV DESC: REMOVED OBSOLETE PART NUMBER AS PER PCN#512128.				molex				
GENERAL TOLERANCES (UNLESS SPECIFIED)						EC NO: 716046		KK 100 PCB ASSY 4455 SERIES DWG				
4 PLACES ± 0.25 ± 0.015						DRWN: SANTHN 2022/07/22						
3 PLACES ± 0.25 ± 0.015						CHKD: GGA 2022/07/29		PRODUCT CUSTOMER DRAWING				
2 PLACES ± 0.25 ± 0.015						APPR: GGA 2022/07/29		DOCUMENT NUMBER				
1 PLACE ± 0.36 ± 0.015						INITIAL REVISION:		SDA-4455		DOC TYPE	DOC PART	REVISION
0 PLACES ± 0.36 ± 0.015						DRWN: SAMIEC 1984/05/10		PSD		001	D18	
ANGULAR TOL ± 0.5°						APPR: LENZ 1984/05/10		MATERIAL NUMBER		CUSTOMER		SHEET NUMBER
DRAFT WHERE APPLICABLE MUST REMAIN WITHIN DIMENSIONS						THIRD ANGLE PROJECTION		DRAWING	SERIES	SEE CHART		GENERAL MARKET
						B-SIZE		4455	5 OF 15			

# KK 100 PCB ASSY 2-25 CKT 4455 SERIES

Ckts	Assy Proc: TOP ENTRY		Assy Proc: TOP ENTRY		Assy Proc: TOP ENTRY		Assy Proc: RIGHT ANGLE	
	Material No	Engineer Number	Material No	Engineer Number	Material No	Engineer Number	Material No	Engineer Number
2			22-18-2022	A-4455-CZ02B(565)				
3			22-18-2032	A-4455-CZ 03 B(565)				
4			22-18-2042	A-4455-CZ 04 B(565)				
5			22-18-2052	A-4455-CZ 05 B(565)				
6			22-18-2062	A-4455-CZ 06 B(565)				
7			22-18-2072	A-4455-CZ 07 B(565)			22-15-2075	A-4455-AA07A(P909)
8			22-18-2082	A-4455-CZ 08 B(565)			22-15-2085	A-4455-AA 08A(P909)
9			22-18-2092	A-4455-CZ 09 B(565)			22-15-2095	A-4455-AA 09A(P909)
10			22-18-2102	A-4455-CZ 10 B(565)			22-15-2105	A-4455-AA 10A(P909)
11			22-18-2112	A-4455-CZ 11 B(565)			22-15-2115	A-4455-AA 11A(P909)
12			22-18-2122	A-4455-CZ 12 B(565)				
13			22-18-2132	A-4455-CZ 13 B(565)			22-15-2135	A-4455-AA 13A(P909)
14			22-18-2142	A-4455-CZ 14 B(565)			22-15-2145	A-4455-AA 14A(P909)
15			22-18-2152	A-4455-CZ 15 B(565)			22-15-2155	A-4455-AA 15A(P909)
16			22-18-2162	A-4455-CZ 16 B(565)			22-15-2165	A-4455-AA 16A(P909)
17			22-18-2172	A-4455-CZ 17 B(565)			22-15-2175	A-4455-AA 17A(P909)
18			22-18-2182	A-4455-CZ 18 B(565)				
19			22-18-2192	A-4455-CZ 19 B(565)			22-15-2195	A-4455-AA 19A(P909)
20			22-18-2202	A-4455-CZ 20 B(565)				
21			22-18-2212	A-4455-CZ 21 B(565)			22-15-2215	A-4455-AA 21A(P909)
22			22-18-2222	A-4455-CZ 22 B(565)			22-15-2225	A-4455-AA 22A(P909)
23			22-18-2232	A-4455-CZ 23 B(565)				
24			22-18-2242	A-4455-CZ 24 B(565)			22-15-2245	A-4455-AA 24A(P909)
25			22-18-2252	A-4455-CZ 25 B(565)			22-15-2255	A-4455-AA 25A(P909)

THIS DRAWING CONTAINS INFORMATION THAT IS PROPRIETARY TO MOLEX ELECTRONIC TECHNOLOGIES, LLC AND SHOULD NOT BE USED WITHOUT WRITTEN PERMISSION											
DIMENSION UNITS <b>MM/IN</b>		SCALE <b>1:1</b>		CURRENT REV DESC: REMOVED OBSOLETE PART NUMBER AS PER PCN#512128.				molex			
GENERAL TOLERANCES (UNLESS SPECIFIED)						EC NO: 716046		KK 100 PCB ASSY 4455 SERIES DWG  PRODUCT CUSTOMER DRAWING			
4 PLACES ±		MM		INCH		DRWN: SANTHN 2022/07/22					
3 PLACES ±		0.25		0.015		CHKD: GGA 2022/07/29					
2 PLACES ±		0.36		±		APPR: GGA 2022/07/29					
1 PLACE ±		0.5°		ANGULAR TOL ±		INITIAL REVISION:		DOCUMENT NUMBER		DOC TYPE DOC PART REVISION	
0 PLACES ±		THIRD ANGLE PROJECTION		DRAWING		SERIES		MATERIAL NUMBER		CUSTOMER	
DRAFT WHERE APPLICABLE MUST REMAIN WITHIN DIMENSIONS		B-SIZE		4455		SEE CHART		GENERAL MARKET		SHEET NUMBER	

# KK 100 PCB ASSY 2-25 CKT

## 4455 SERIES

Ckts	Assy Proc: RIGHT ANGLE		Assy Proc: RIGHT ANGLE		Assy Proc: RIGHT ANGLE		Assy Proc: RIGHT ANGLE	
	Material No	Engineer Number	Material No	Engineer Number	Material No	Engineer Number	Material No	Engineer Number
2					22-15-4024	A-4455-AB02A(P909)		
3					22-15-4034	A-4455-AB 03A(P909)		
4					22-15-4044	A-4455-AB 04A(P909)		
5					22-15-4054	A-4455-AB 05A(P909)		
6			50-34-8518	A-4455-AB 06 A(228)	22-15-4064	A-4455-AB 06A(P909)		
7					22-15-4074	A-4455-AB 07A(P909)		
8					22-15-4084	A-4455-AB 08A(P909)		
9	22-16-2096	A-4455-AA 09 A(208)			22-15-4094	A-4455-AB 09A(P909)		
10							22-15-2102	A-4455-AE 10A(P909)
11					22-15-4114	A-4455-AB 11A(P909)		
12					22-15-4124	A-4455-AB 12A(P909)		
13					22-15-4134	A-4455-AB 13A(P909)		
14					22-15-4144	A-4455-AB 14A(P909)		
15					22-15-4154	A-4455-AB 15A(P909)		
16					22-15-4164	A-4455-AB 16A(P909)		
17					22-15-4174	A-4455-AB 17A(P909)		
18	22-16-2186	A-4455-AA 18 A(208)						
19	22-16-2196	A-4455-AA 19 A(208)			22-15-4194	A-4455-AB 19A(P909)		
20	22-16-2206	A-4455-AA 20 A(208)			22-15-4204	A-4455-AB 20A(P909)		
21	22-16-2216	A-4455-AA 21 A(208)			22-15-4214	A-4455-AB 21A(P909)		
22	22-16-2226	A-4455-AA 22 A(208)			22-15-4224	A-4455-AB 22A(P909)		
23	22-16-2236	A-4455-AA 23 A(208)			22-15-4234	A-4455-AB 23A(P909)		
24					22-15-4244	A-4455-AB 24A(P909)		
25					22-15-4254	A-4455-AB 25A(P909)	22-15-2252	A-4455-AE 25A(P909)

THIS DRAWING CONTAINS INFORMATION THAT IS PROPRIETARY TO MOLEX ELECTRONIC TECHNOLOGIES, LLC AND SHOULD NOT BE USED WITHOUT WRITTEN PERMISSION									
DIMENSION UNITS <b>MM/IN</b>	SCALE <b>1:1</b>	CURRENT REV DESC: REMOVED OBSOLETE PART NUMBER AS PER PCN#512128.			molex				
GENERAL TOLERANCES (UNLESS SPECIFIED)		EC NO: 716046			KK 100 PCB ASSY 4455 SERIES DWG				
4 PLACES ± 0.25 ± 0.015		DRWN: SANTHN 2022/07/22							
3 PLACES ± 0.25 ± 0.015		CHKD: GGA 2022/07/29			PRODUCT CUSTOMER DRAWING				
2 PLACES ± 0.25 ± 0.015		APPR: GGA 2022/07/29			DOCUMENT NUMBER				
1 PLACE ± 0.36 ± 0.015		INITIAL REVISION:			DOC TYPE DOC PART REVISION				
0 PLACES ± 0.36 ± 0.015		DRWN: SAMIEC 1984/05/10			SDA-4455				
ANGULAR TOL ± 0.5°		APPR: LENZ 1984/05/10			PSD 001 D18				
DRAFT WHERE APPLICABLE MUST REMAIN WITHIN DIMENSIONS		THIRD ANGLE PROJECTION		DRAWING	SERIES	MATERIAL NUMBER		CUSTOMER	
				B-SIZE	4455	SEE CHART		GENERAL MARKET	
						SHEET NUMBER		7 OF 15	

# KK 100 PCB ASSY 2-25 CKT 4455 SERIES

Ckts	Assy Proc: RIGHT ANGLE		Assy Proc: RIGHT ANGLE		Assy Proc: RIGHT ANGLE		Assy Proc: RIGHT ANGLE	
	Material No	Engineer Number	Material No	Engineer Number	Material No	Engineer Number	Material No	Engineer Number
2	22-15-4022	A-4455-AR02A(P909)			22-17-5023	A-4455-AZ02B(228)		
3	22-15-4032	A-4455-AR 03 A(P909)			22-17-5033	A-4455-AZ 03 B(228)		
4	22-15-4042	A-4455-AR 04 A(P909)			22-17-5043	A-4455-AZ 04 B(228)		
5	22-15-4052	A-4455-AR 05 A(P909)						
6	22-15-4062	A-4455-AR 06 A(P909)			22-17-5063	A-4455-AZ 06 B(228)		
7	22-15-4072	A-4455-AR 07 A(P909)			22-17-5073	A-4455-AZ 07 B(228)		
8	22-15-4082	A-4455-AR 08 A(P909)			22-17-5083	A-4455-AZ 08 B(228)		
9	22-15-4092	A-4455-AR 09 A(P909)			22-17-5093	A-4455-AZ 09 B(228)		
10	22-15-4102	A-4455-AR 10 A(P909)			22-17-5103	A-4455-AZ 10 B(228)		
11	22-15-4112	A-4455-AR 11 A(P909)			22-17-5113	A-4455-AZ 11 B(228)		
12	22-15-4122	A-4455-AR 12 A(P909)			22-17-5123	A-4455-AZ 12 B(228)		
13	22-15-4132	A-4455-AR 13 A(P909)			22-17-5133	A-4455-AZ 13 B(228)		
14	22-15-4142	A-4455-AR 14 A(P909)			22-17-5143	A-4455-AZ 14 B(228)		
15	22-15-4152	A-4455-AR 15 A(P909)			22-17-5153	A-4455-AZ 15 B(228)		
16	22-15-4162	A-4455-AR 16 A(P909)			22-17-5163	A-4455-AZ 16 B(228)		
17	22-15-4172	A-4455-AR 17 A(P909)			22-17-5173	A-4455-AZ 17 B(228)		
18	22-15-4182	A-4455-AR 18 A(P909)			22-17-5183	A-4455-AZ 18 B(228)		
19	22-15-4192	A-4455-AR 19 A(P909)			22-17-5193	A-4455-AZ 19 B(228)		
20	22-15-4202	A-4455-AR 20 A(P909)	22-17-5201	A-4455-AZ 20 A(228)	22-17-5203	A-4455-AZ 20 B(228)		
21	22-15-4212	A-4455-AR 21 A(P909)			22-17-5213	A-4455-AZ 21 B(228)		
22	22-15-4222	A-4455-AR 22 A(P909)			22-17-5223	A-4455-AZ 22 B(228)		
23	22-15-4232	A-4455-AR 23 A(P909)			22-17-5233	A-4455-AZ 23 B(228)		
24	22-15-4242	A-4455-AR 24 A(P909)			22-17-5243	A-4455-AZ 24 B(228)		
25	22-15-4252	A-4455-AR 25 A(P909)			22-17-5253	A-4455-AZ 25 B(228)		

THIS DRAWING CONTAINS INFORMATION THAT IS PROPRIETARY TO MOLEX ELECTRONIC TECHNOLOGIES, LLC AND SHOULD NOT BE USED WITHOUT WRITTEN PERMISSION											
DIMENSION UNITS <b>MM/IN</b>		SCALE <b>1:1</b>		CURRENT REV DESC: REMOVED OBSOLETE PART NUMBER AS PER PCN#512128.				molex			
GENERAL TOLERANCES (UNLESS SPECIFIED)						EC NO: 716046		DRWN: SANTHN		2022/07/22	
4 PLACES ±		MM		INCH		CHKD: GGA		2022/07/29		APPR: GGA	
3 PLACES ±		0.25		0.015		INITIAL REVISION:		DRWN: SAMIEC		1984/05/10	
2 PLACES ±		0.36		±		APPR: LENZ		1984/05/10		DOCUMENT NUMBER	
1 PLACE ±		0.5		°		THIRD ANGLE PROJECTION		DRAWING		SERIES	
ANGULAR TOL ±		0.5		°		B-SIZE		4455		MATERIAL NUMBER	
DRAFT WHERE APPLICABLE MUST REMAIN WITHIN DIMENSIONS		THIRD ANGLE PROJECTION		DRAWING		SERIES		MATERIAL NUMBER		CUSTOMER	
DOCUMENT STATUS		P1		RELEASE DATE		2022/07/29 12:32:02		SEE CHART		GENERAL MARKET	
9		8		7		6		5		4	
3		2		1		8 OF 15		SHEET NUMBER		8 OF 15	





# KK 100 PCB ASSY 2-25 CKT 4455 SERIES

Ckts	Assy Proc: TOP ENTRY		Assy Proc: TOP ENTRY		Assy Proc: TOP ENTRY		Assy Proc: TOP ENTRY	
		Hooks Cut:	YES	Hooks Cut:	YES	Hooks Cut:	YES	Hooks Cut:
	Housing No:	4455-NR	Housing No:	4455-N	Housing No:	4455-N	Housing No:	4455-BN
	Terminal No:	4316-4(208)	Terminal No:	4316-4(565)	Terminal No:	4316-4(P909)	Terminal No:	4316-4(P909)
	Dim C:	3.35 / .132	Dim C:	3.35 / .132	Dim C:	3.35 / .132	Dim C:	3.35 / .132
	Plating:	208	Plating:	565	Plating:	P909	Plating:	P909
	Packaging:	PK-44646-003	Packaging:	PK-44646-003	Packaging:	PK-44646-003	Packaging:	PK-44646-002
	Voids:	NO	Voids:	NO	Voids:	NO	Voids:	NO
	Material No	Engineer Number	Material No	Engineer Number	Material No	Engineer Number	Material No	Engineer Number
2			22-18-2026	A-4455-CY02A(565)	22-02-7023	A-4455-CY02A(P909)	22-15-4028	A-4455-CB02A(P909)
3			22-18-2036	A-4455-CY 03 A(565)	22-02-7033	A-4455-CY 03A(P909)	22-15-4038	A-4455-CB 03A(P909)
4			22-18-2046	A-4455-CY 04 A(565)	22-02-7043	A-4455-CY 04A(P909)	22-15-4048	A-4455-CB 04A(P909)
5	22-18-2057	A-4455-CP 05 A(208)			22-02-7053	A-4455-CY 05A(P909)	22-15-4058	A-4455-CB 05A(P909)
6			22-18-2066	A-4455-CY 06 A(565)	22-02-7063	A-4455-CY 06A(P909)	22-15-4068	A-4455-CB 06A(P909)
7					22-02-7073	A-4455-CY 07A(P909)	22-15-4078	A-4455-CB 07A(P909)
8					22-02-7083	A-4455-CY 08A(P909)	22-15-4088	A-4455-CB 08A(P909)
9					22-02-7093	A-4455-CY 09A(P909)	22-15-4098	A-4455-CB 09A(P909)
10					22-02-7103	A-4455-CY 10A(P909)	22-15-4108	A-4455-CB 10A(P909)
11					22-02-7113	A-4455-CY 11A(P909)	22-15-4118	A-4455-CB 11A(P909)
12			22-18-2126	A-4455-CY 12 A(565)	22-02-7123	A-4455-CY 12A(P909)	22-15-4128	A-4455-CB 12A(P909)
13					22-02-7133	A-4455-CY 13A(P909)	22-15-4138	A-4455-CB 13A(P909)
14			22-18-2146	A-4455-CY 14 A(565)	22-02-7143	A-4455-CY 14A(P909)	22-15-4148	A-4455-CB 14A(P909)
15			22-18-2156	A-4455-CY 15 A(565)	22-02-7153	A-4455-CY 15A(P909)	22-15-4158	A-4455-CB 15A(P909)
16			22-18-2166	A-4455-CY 16 A(565)	22-02-7163	A-4455-CY 16A(P909)	22-15-4168	A-4455-CB 16A(P909)
17			22-18-2176	A-4455-CY 17 A(565)	22-02-7173	A-4455-CY 17A(P909)	22-15-4178	A-4455-CB 17A(P909)
18			22-18-2186	A-4455-CY 18 A(565)	22-02-7183	A-4455-CY 18A(P909)		
19			22-18-2196	A-4455-CY 19 A(565)	22-02-7193	A-4455-CY 19A(P909)	22-15-4198	A-4455-CB 19A(P909)
20			22-18-2206	A-4455-CY 20 A(565)	22-02-7203	A-4455-CY 20A(P909)	22-15-4208	A-4455-CB 20A(P909)
21			22-18-2216	A-4455-CY 21 A(565)	22-02-7213	A-4455-CY 21A(P909)	22-15-4218	A-4455-CB 21A(P909)
22			22-18-2226	A-4455-CY 22 A(565)	22-02-7223	A-4455-CY 22A(P909)	22-15-4228	A-4455-CB 22A(P909)
23			22-18-2236	A-4455-CY 23 A(565)	22-02-7233	A-4455-CY 23A(P909)	22-15-4238	A-4455-CB 23A(P909)
24			22-18-2246	A-4455-CY 24 A(565)			22-15-4248	A-4455-CB 24A(P909)
25			22-18-2256	A-4455-CY 25 A(565)			22-15-4258	A-4455-CB 25A(P909)

THIS DRAWING CONTAINS INFORMATION THAT IS PROPRIETARY TO MOLEX ELECTRONIC TECHNOLOGIES, LLC AND SHOULD NOT BE USED WITHOUT WRITTEN PERMISSION									
DIMENSION UNITS	SCALE	CURRENT REV DESC: REMOVED OBSOLETE PART NUMBER AS PER PCN#512128.			molex				
MM/IN	1:1				KK 100 PCB ASSY 4455 SERIES DWG				
GENERAL TOLERANCES (UNLESS SPECIFIED)					PRODUCT CUSTOMER DRAWING				
	MM	INCH							
4 PLACES	±								
3 PLACES	±	0.01							
2 PLACES	±	0.25 ± 0.015							
1 PLACE	±	0.36							
0 PLACES	±								
ANGULAR TOL	±	0.5°							
DRAFT WHERE APPLICABLE MUST REMAIN WITHIN DIMENSIONS		THIRD ANGLE PROJECTION			DRAWING		SERIES		
					B-SIZE		4455		
DOCUMENT STATUS		P1			RELEASE DATE		2022/07/29 12:32:02		
		9			8		7		
		6			5		4		
		3			2		1		

# KK 100 PCB ASSY 2-25 CKT 4455 SERIES

Ckts	Assy Proc: TOP ENTRY		Assy Proc: TOP ENTRY		Assy Proc: TOP ENTRY		Assy Proc: TOP ENTRY	
	Material No	Engineer Number	Material No	Engineer Number	Material No	Engineer Number	Material No	Engineer Number
2	22-65-3020	A-4455-CR02A(P909)			22-18-7023	A-4455-CY02A(208)	22-18-7021	A-4455-CY02B(228)
3	22-65-3030	A-4455-CR 03A(P909)			22-18-7033	A-4455-CY 03 A(208)	22-18-7031 38-00-1478	A-4455-CY 03 B(228)
4	22-65-3040	A-4455-CR 04A(P909)			22-18-7043	A-4455-CY 04 A(208)	22-18-7041	A-4455-CY 04 B(228)
5	22-65-3050	A-4455-CR 05A(P909)			22-18-7053	A-4455-CY 05 A(208)	22-18-7051	A-4455-CY 05 B(228)
6	22-65-3060	A-4455-CR 06A(P909)			22-18-7063	A-4455-CY 06 A(208)	22-18-7061	A-4455-CY 06 B(228)
7	22-65-3070	A-4455-CR 07A(P909)			22-18-7073	A-4455-CY 07 A(208)	22-18-7071	A-4455-CY 07 B(228)
8	22-65-3080	A-4455-CR 08A(P909)			22-18-7083	A-4455-CY 08 A(208)	22-18-7081	A-4455-CY 08 B(228)
9	22-65-3090	A-4455-CR 09A(P909)			22-18-7093	A-4455-CY 09 A(208)	22-18-7091	A-4455-CY 09 B(228)
10	22-65-3100	A-4455-CR 10A(P909)			22-18-7103	A-4455-CY 10 A(208)	22-18-7101	A-4455-CY 10 B(228)
11	22-65-3110	A-4455-CR 11A(P909)			22-18-7113	A-4455-CY 11 A(208)	22-18-7111	A-4455-CY 11 B(228)
12	22-65-3120	A-4455-CR 12A(P909)	22-18-2124	A-4455-CZ 12 B(228)	22-18-7123	A-4455-CY 12 A(208)	22-18-7121	A-4455-CY 12 B(228)
13	22-65-3130	A-4455-CR 13A(P909)			22-18-7133	A-4455-CY 13 A(208)	22-18-7131	A-4455-CY 13 B(228)
14	22-65-3140	A-4455-CR 14A(P909)			22-18-7143	A-4455-CY 14 A(208)	22-18-7141	A-4455-CY 14 B(228)
15	22-65-3150	A-4455-CR 15A(P909)			22-18-7153	A-4455-CY 15 A(208)	22-18-7151	A-4455-CY 15 B(228)
16	22-65-3160	A-4455-CR 16A(P909)	22-18-2164	A-4455-CZ 16 B(228)	22-18-7163	A-4455-CY 16 A(208)	22-18-7161	A-4455-CY 16 B(228)
17	22-65-3170	A-4455-CR 17A(P909)			22-18-7173	A-4455-CY 17 A(208)	22-18-7171	A-4455-CY 17 B(228)
18	22-65-3180	A-4455-CR 18A(P909)			22-18-7183	A-4455-CY 18 A(208)	22-18-7181	A-4455-CY 18 B(228)
19	22-65-3190	A-4455-CR 19A(P909)	22-18-2194	A-4455-CZ 19 B(228)	22-18-7193	A-4455-CY 19 A(208)	22-18-7191	A-4455-CY 19 B(228)
20	22-65-3200	A-4455-CR 20A(P909)			22-18-7203	A-4455-CY 20 A(208)	22-18-7201	A-4455-CY 20 B(228)
21	22-65-3210	A-4455-CR 21A(P909)			22-18-7213	A-4455-CY 21 A(208)	22-18-7211	A-4455-CY 21 B(228)
22	22-65-3220	A-4455-CR 22A(P909)			22-18-7223	A-4455-CY 22 A(208)	22-18-7221	A-4455-CY 22 B(228)
23	22-65-3230	A-4455-CR 23A(P909)			22-18-7233	A-4455-CY 23 A(208)	22-18-7231	A-4455-CY 23 B(228)
24	22-65-3240	A-4455-CR 24A(P909)			22-18-7243	A-4455-CY 24 A(208)		
25	22-65-3250	A-4455-CR 25A(P909)			22-18-7253	A-4455-CY 25 A(208)	22-18-7251	A-4455-CY 25 B(228)

THIS DRAWING CONTAINS INFORMATION THAT IS PROPRIETARY TO MOLEX ELECTRONIC TECHNOLOGIES, LLC AND SHOULD NOT BE USED WITHOUT WRITTEN PERMISSION									
DIMENSION UNITS <b>MM/IN</b>	SCALE <b>1:1</b>	CURRENT REV DESC: REMOVED OBSOLETE PART NUMBER AS PER PCN#512128.			molex				
GENERAL TOLERANCES (UNLESS SPECIFIED)		EC NO: 716046			KK 100 PCB ASSY 4455 SERIES DWG				
4 PLACES ± 0.25 ± 0.015		DRWN: SANTHN 2022/07/22							
3 PLACES ± 0.25 ± 0.015		CHKD: GGA 2022/07/29			PRODUCT CUSTOMER DRAWING				
2 PLACES ± 0.25 ± 0.015		APPR: GGA 2022/07/29			DOCUMENT NUMBER		DOC TYPE	DOC PART	REVISION
1 PLACE ± 0.36 ± 0.015		INITIAL REVISION:			SDA-4455		PSD	001	D18
0 PLACES ± 0.36 ± 0.015		DRWN: SAMIEC 1984/05/10			MATERIAL NUMBER		CUSTOMER		SHEET NUMBER
ANGULAR TOL ± 0.5°		APPR: LENZ 1984/05/10			SEE CHART		GENERAL MARKET		11 OF 15
DRAFT WHERE APPLICABLE MUST REMAIN WITHIN DIMENSIONS		THIRD ANGLE PROJECTION		DRAWING	SERIES	MATERIAL NUMBER		CUSTOMER	
				B-SIZE	4455	SEE CHART		GENERAL MARKET	

# KK 100 PCB ASSY 2-25 CKT 4455 SERIES

Ckts	Assy Proc: RIGHT ANGLE		Assy Proc: BOTTOM ENTRY		Assy Proc: RIGHT ANGLE		Assy Proc: RIGHT ANGLE	
	Material No	Engineer Number	Material No	Engineer Number	Material No	Engineer Number	Material No	Engineer Number
2	38-00-1332	A-4455-AZ02C(P909)	38-00-1392	A-4455-BH02F(P909)				
3	38-00-1333	A-4455-AZ03C(P909)	38-00-1393	A-4455-BH03F(P909)				
4	38-00-1334	A-4455-AZ04C(P909)	38-00-1394	A-4455-BH04F(P909)				
5	38-00-1335	A-4455-AZ05C(P909)	38-00-1395	A-4455-BH05F(P909)				
6	38-00-1336	A-4455-AZ06C(P909)	38-00-1396	A-4455-BH06F(P909)				
7	38-00-1337	A-4455-AZ07C(P909)	38-00-1397	A-4455-BH07F(P909)	22-14-2079	A-4455-AA07B(P909)	22-14-2077	A-4455-AA07A(565)
8	38-00-1338	A-4455-AZ08C(P909)	38-00-1398	A-4455-BH08F(P909)	22-14-2089	A-4455-AA 08 B(P909)	22-14-2087	A-4455-AA 08 A(565)
9	38-00-1339	A-4455-AZ09C(P909)	38-00-1399	A-4455-BH09F(P909)	22-14-2099	A-4455-AA 09 B(P909)	22-14-2097	A-4455-AA 09 A(565)
10	38-00-1340	A-4455-AZ10C(P909)	38-00-1400	A-4455-BH10F(P909)	22-14-2109	A-4455-AA 10 B(P909)	22-14-2107	A-4455-AA 10 A(565)
11	38-00-1341	A-4455-AZ11C(P909)	38-00-1401	A-4455-BH11F(P909)	22-14-2119	A-4455-AA 11 B(P909)	22-14-2117	A-4455-AA 11 A(565)
12	38-00-1342	A-4455-AZ12C(P909)	38-00-1402	A-4455-BH12F(P909)	22-14-2129	A-4455-AA 12 B(P909)	22-14-2127	A-4455-AA 12 A(565)
13	38-00-1343	A-4455-AZ13C(P909)	38-00-1403	A-4455-BH13F(P909)	22-14-2139	A-4455-AA 13 B(P909)	22-14-2137	A-4455-AA 13 A(565)
14	38-00-1344	A-4455-AZ14C(P909)	38-00-1404	A-4455-BH14F(P909)	22-14-2149	A-4455-AA 14 B(P909)	22-14-2147	A-4455-AA 14 A(565)
15	38-00-1345	A-4455-AZ15C(P909)	38-00-1405	A-4455-BH15F(P909)	22-14-2159	A-4455-AA 15 B(P909)	22-14-2157	A-4455-AA 15 A(565)
16	38-00-1346	A-4455-AZ16C(P909)	38-00-1406	A-4455-BH16F(P909)	22-14-2169	A-4455-AA 16 B(P909)	22-14-2167	A-4455-AA 16 A(565)
17	38-00-1347	A-4455-AZ17C(P909)	38-00-1407	A-4455-BH17F(P909)	22-14-2179	A-4455-AA 17 B(P909)	22-14-2177	A-4455-AA 17 A(565)
18	38-00-1348	A-4455-AZ18C(P909)	38-00-1408	A-4455-BH18F(P909)	22-14-2189	A-4455-AA 18 B(P909)	22-14-2187	A-4455-AA 18 A(565)
19	38-00-1349	A-4455-AZ19C(P909)	38-00-1409	A-4455-BH19F(P909)	22-14-2199	A-4455-AA 19 B(P909)	22-14-2197	A-4455-AA 19 A(565)
20	38-00-1350	A-4455-AZ20C(P909)	38-00-1410	A-4455-BH20F(P909)	22-14-2209	A-4455-AA 20 B(P909)	22-14-2207	A-4455-AA 20 A(565)
21					22-14-2219	A-4455-AA 21 B(P909)	22-14-2217	A-4455-AA 21 A(565)
22					22-14-2229	A-4455-AA 22 B(P909)	22-14-2227	A-4455-AA 22 A(565)
23					22-14-2239	A-4455-AA 23 B(P909)	22-14-2237	A-4455-AA 23 A(565)
24					22-14-2249	A-4455-AA 24 B(P909)	22-14-2247	A-4455-AA 24 A(565)
25					22-14-2259	A-4455-AA 25 B(P909)	22-14-2257	A-4455-AA 25 A(565)

THIS DRAWING CONTAINS INFORMATION THAT IS PROPRIETARY TO MOLEX ELECTRONIC TECHNOLOGIES, LLC AND SHOULD NOT BE USED WITHOUT WRITTEN PERMISSION																															
DIMENSION UNITS		SCALE		CURRENT REV DESC: REMOVED OBSOLETE PART NUMBER AS PER PCN#512128.				molex																							
MM/IN		1:1																													
GENERAL TOLERANCES (UNLESS SPECIFIED)				EC NO: 716046 DRWN: SANTHN 2022/07/22 CHKD: GGA 2022/07/29 APPR: GGA 2022/07/29				PRODUCT CUSTOMER DRAWING																							
<table border="1" style="width: 100%; border-collapse: collapse;"> <tr><th></th><th>MM</th><th>INCH</th></tr> <tr><td>4 PLACES</td><td>±</td><td>±</td></tr> <tr><td>3 PLACES</td><td>±</td><td>± 0.01</td></tr> <tr><td>2 PLACES</td><td>± 0.25</td><td>± 0.015</td></tr> <tr><td>1 PLACE</td><td>± 0.36</td><td>±</td></tr> <tr><td>0 PLACES</td><td>±</td><td>±</td></tr> </table>													MM	INCH	4 PLACES	±	±	3 PLACES	±	± 0.01	2 PLACES	± 0.25	± 0.015	1 PLACE	± 0.36	±	0 PLACES	±	±	INITIAL REVISION: DRWN: SAMIEC 1984/05/10 APPR: LENZ 1984/05/10	
	MM	INCH																													
4 PLACES	±	±																													
3 PLACES	±	± 0.01																													
2 PLACES	± 0.25	± 0.015																													
1 PLACE	± 0.36	±																													
0 PLACES	±	±																													
ANGULAR TOL ± 0.5°				THIRD ANGLE PROJECTION		DRAWING		SERIES		REVISION																					
DRAFT WHERE APPLICABLE MUST REMAIN WITHIN DIMENSIONS						B-SIZE		4455		SHEET NUMBER																					
SEE CHART				GENERAL MARKET				SDA-4455		PSD 001 D18																					

# KK 100 PCB ASSY 2-25 CKT

## 4455 SERIES

Ckts	Assy Proc: RIGHT ANGLE		Assy Proc: RIGHT ANGLE		Assy Proc: TOP ENTRY		Assy Proc: TOP ENTRY	
	Material No	Engineer Number	Material No	Engineer Number	Material No	Engineer Number	Material No	Engineer Number
2			22-16-3028	A-4455-AB02A(565)	38-00-1422	A-4455-CZ02C(P909)		
3			22-16-3038	A-4455-AB 03 A(565)	38-00-1423	A-4455-CZ03C(P909)		
4			22-16-3048	A-4455-AB 04 A(565)	38-00-1424	A-4455-CZ04C(P909)		
5			22-16-3058	A-4455-AB 05 A(565)	38-00-1425	A-4455-CZ05C(P909)		
6			22-16-3068	A-4455-AB 06 A(565)	38-00-1426	A-4455-CZ06C(P909)	22-02-3068	A-4455-CW06A(P909)-2
7	22-14-3617	A-4455-AA07T(P909)	22-16-3078	A-4455-AB 07 A(565)	38-00-1427	A-4455-CZ07C(P909)	50-29-0004	A-4455-CW07A(P909)-2
8	22-14-3618	A-4455-AA 08 T(P909)	22-16-3088	A-4455-AB 08 A(565)	38-00-1428	A-4455-CZ08C(P909)		
9	22-14-3619	A-4455-AA 09 T(P909)	22-16-3098	A-4455-AB 09 A(565)	38-00-1429	A-4455-CZ09C(P909)		
10	22-14-3711	A-4455-AA 10 T(P909)	22-16-3108	A-4455-AB 10 A(565)	38-00-1430	A-4455-CZ10C(P909)		
11	22-14-3712	A-4455-AA 11 T(P909)	22-16-3118	A-4455-AB 11 A(565)	38-00-1431	A-4455-CZ11C(P909)		
12	22-14-3713	A-4455-AA 12 T(P909)	22-16-3128	A-4455-AB 12 A(565)	38-00-1432	A-4455-CZ12C(P909)		
13	22-14-3714	A-4455-AA 13 T(P909)	22-16-3138	A-4455-AB 13 A(565)	38-00-1433	A-4455-CZ13C(P909)		
14	22-14-3715	A-4455-AA 14 T(P909)	22-16-3148	A-4455-AB 14 A(565)	38-00-1434	A-4455-CZ14C(P909)		
15	22-14-3716	A-4455-AA 15 T(P909)	22-16-3158	A-4455-AB 15 A(565)	38-00-1435	A-4455-CZ15C(P909)		
16	22-14-3717	A-4455-AA 16 T(P909)	22-16-3168	A-4455-AB 16 A(565)	38-00-1436	A-4455-CZ16C(P909)		
17	22-14-3718	A-4455-AA 17 T(P909)	22-16-3178	A-4455-AB 17 A(565)	38-00-1437	A-4455-CZ17C(P909)		
18	22-14-3719	A-4455-AA 18 T(P909)	22-16-3188	A-4455-AB 18 A(565)	38-00-1438	A-4455-CZ18C(P909)		
19	22-14-3811	A-4455-AA 19 T(P909)	22-16-3198	A-4455-AB 19 A(565)	38-00-1439	A-4455-CZ19C(P909)		
20	22-14-3812	A-4455-AA 20 T(P909)	22-16-3208	A-4455-AB 20 A(565)	38-00-1440	A-4455-CZ20C(P909)		
21	22-14-3813	A-4455-AA 21 T(P909)	22-16-3218	A-4455-AB 21 A(565)				
22	22-14-3814	A-4455-AA 22 T(P909)	22-16-3228	A-4455-AB 22 A(565)				
23	22-14-3815	A-4455-AA 23 T(P909)	22-16-3238	A-4455-AB 23 A(565)				
24	22-14-3816	A-4455-AA 24 T(P909)	22-16-3248	A-4455-AB 24 A(565)				
25			22-16-3258	A-4455-AB 25 A(565)				

THIS DRAWING CONTAINS INFORMATION THAT IS PROPRIETARY TO MOLEX ELECTRONIC TECHNOLOGIES, LLC AND SHOULD NOT BE USED WITHOUT WRITTEN PERMISSION											
DIMENSION UNITS <b>MM/IN</b>		SCALE <b>1:1</b>		CURRENT REV DESC: REMOVED OBSOLETE PART NUMBER AS PER PCN#512128.							
GENERAL TOLERANCES (UNLESS SPECIFIED)						EC NO: 716046 DRWN: SANTHN CHKD: GGA APPR: GGA		2022/07/22 2022/07/29 2022/07/29		KK 100 PCB ASSY 4455 SERIES DWG	
4 PLACES ±		3 PLACES ±		2 PLACES ±		1 PLACE ±		0 PLACES ±		PRODUCT CUSTOMER DRAWING	
± 0.25		± 0.015		± 0.36		± 0.5°				DOCUMENT NUMBER <b>SDA-4455</b>	
										DOC TYPE DOC PART REVISION <b>PSD 001 D18</b>	
DRAFT WHERE APPLICABLE MUST REMAIN WITHIN DIMENSIONS				THIRD ANGLE PROJECTION 		DRAWING <b>B-SIZE</b>		SERIES <b>4455</b>		MATERIAL NUMBER CUSTOMER SHEET NUMBER SEE CHART GENERAL MARKET 13 OF 15	

# KK 100 PCB ASSY 2-25 CKT 4455 SERIES

Ckts	Assy Proc: TOP ENTRY		Assy Proc: TOP ENTRY		Assy Proc: BOTTOM ENTRY		Assy Proc: BOTTOM ENTRY	
	Material No	Engineer Number	Material No	Engineer Number	Material No	Engineer Number	Material No	Engineer Number
2								
3								
4								
5	50-29-1553	A-4455-CY 05B(P909)						
6	50-29-1554	A-4455-CY 06B(P909)	22-15-5065	A-4455-CY06A(P909)-2				
7								
8								
9								
10								
11					50-36-1881	A-4455-BH11D(P909)-10		
12								
13							26-01-3099	A-4455-BH13D(208)-51
14								
15								
16								
17								
18								
19								
20								
21								
22								
23								
24								
25								

THIS DRAWING CONTAINS INFORMATION THAT IS PROPRIETARY TO MOLEX ELECTRONIC TECHNOLOGIES, LLC AND SHOULD NOT BE USED WITHOUT WRITTEN PERMISSION									
DIMENSION UNITS <b>MM/IN</b>	SCALE <b>1:1</b>	CURRENT REV DESC: REMOVED OBSOLETE PART NUMBER AS PER PCN#512128.			molex				
GENERAL TOLERANCES (UNLESS SPECIFIED)		EC NO: 716046			KK 100 PCB ASSY 4455 SERIES DWG				
4 PLACES ±	±	DRWN: SANTHN 2022/07/22			PRODUCT CUSTOMER DRAWING				
3 PLACES ±	± 0.01	CHKD: GGA 2022/07/29			DOCUMENT NUMBER				
2 PLACES ± 0.25	± 0.015	APPR: GGA 2022/07/29			SDA-4455				
1 PLACE ± 0.36	±	INITIAL REVISION:			1984/05/10		DOC TYPE	DOC PART	REVISION
0 PLACES ±	±	DRWN: SAMIEC 1984/05/10			1984/05/10		PSD	001	D18
ANGULAR TOL ± 0.5°		APPR: LENZ			SHEET NUMBER				
DRAFT WHERE APPLICABLE MUST REMAIN WITHIN DIMENSIONS		THIRD ANGLE PROJECTION	DRAWING	SERIES	MATERIAL NUMBER	CUSTOMER		14 OF 15	
			<b>B-SIZE</b>	<b>4455</b>	SEE CHART	GENERAL MARKET			

# KK 100 PCB ASSY 2-25 CKT 4455 SERIES

Ckts	Material No	Engineer Number	Material No	Engineer Number	Material No	Engineer Number	Material No	Engineer Number
2								
3			46999-0585	A-4455-CG03A(P909)			22-02-2031	A-4455-CY 03A(P909)
4			46999-0583	A-4455-CG04A(P909)				
5								
6			46999-0584	A-4455-CG06A(P909)				
7								
8					46999-0599	A-4455-CP 08A(P909)		
9								
10								
11								
12								
13								
14			46999-0586	A-4455-CG14A(P909)				
15								
16								
17	46999-0582	A-4455-AB17A(P909)-51						
18								
19								
20								
21								
22								
23								
24								
25								

THIS DRAWING CONTAINS INFORMATION THAT IS PROPRIETARY TO MOLEX ELECTRONIC TECHNOLOGIES, LLC AND SHOULD NOT BE USED WITHOUT WRITTEN PERMISSION														
DIMENSION UNITS	SCALE	CURRENT REV DESC: REMOVED OBSOLETE PART NUMBER AS PER PCN#512128.									molex			
MM/IN	1:1										KK 100 PCB ASSY 4455 SERIES DWG			
GENERAL TOLERANCES (UNLESS SPECIFIED)											PRODUCT CUSTOMER DRAWING			
4 PLACES	±	MM	INCH									DOCUMENT NUMBER		
3 PLACES	±	0.25	0.015									DOC TYPE DOC PART REVISION		
2 PLACES	±	0.25	0.015									SDA-4455 PSD 001 D18		
1 PLACE	±	0.36	±									MATERIAL NUMBER CUSTOMER SHEET NUMBER		
0 PLACES	±	±	±									SEE CHART GENERAL MARKET 15 OF 15		
ANGULAR TOL ± 0.5°				THIRD ANGLE PROJECTION				DRAWING	SERIES					
DRAFT WHERE APPLICABLE MUST REMAIN WITHIN DIMENSIONS								B-SIZE	4455					