Pch Load Switch IC with Current Sense and Voltage Sense

NO.EA-292-201202

OUTLINE

The R5550K Series are CMOS-based load switch ICs. Pch Tr. is used to achieve low On resistance (TYP.180mΩ) and low supply current (TYP. 2.6μA at no-load operation). Internally, a single IC consists of a voltage reference unit, an error amplifier, resistors for setting output voltage and a current limit circuit. Output voltage is fixed inside the IC with high accuracy. The R5550K is suitable for monitoring abnormal current which may flow from lithium ion battery (one cell) to power lines connected to each load. If the abnormal current is detected, the switch turns off after a certain period of time (Dead-time).

If overcurrent is detected, switch turns off after dead-time of 10ms. If the output current exceeds the output current limit, the output current limit circuit immediately controls the output current after the short current response time of 4μs. Then, switch turns off after dead-time of 1.33ms.

The R5550K also includes a voltage sense pin which monitors abnormal voltage. If abnormal voltage is detected, switch turns off after dead-time of 10ms.

As protection circuits, the R5550K contains an output current limit circuit, a short-current protection circuit, and an undervoltage lockout (UVLO) circuit.

The R5550K is available in a DFN(PL)1010-4F package which enables the high-density mounting.

FEATURES

- A single built-in Pch MOSFET
- Input Voltage Range 2.3V to 5.25V
- Supply Current (I_{OUT}=0mA) TYP. 2.6μA
- Switch On Resistance TYP. 180mΩ (V_{IN}=3.3V)
- Output Current MIN. 1000mA
- Package DFN(PL)1010-4F
- Current Limit Threshold MIN. 300mA
- Output Current Limit MIN. 1000mA
- Switching Operation (After turn-off) Automatic Recovery Type

APPLICATIONS

- Load Switch for portable communication equipments

BLOCK DIAGRAMS

R5550K001A

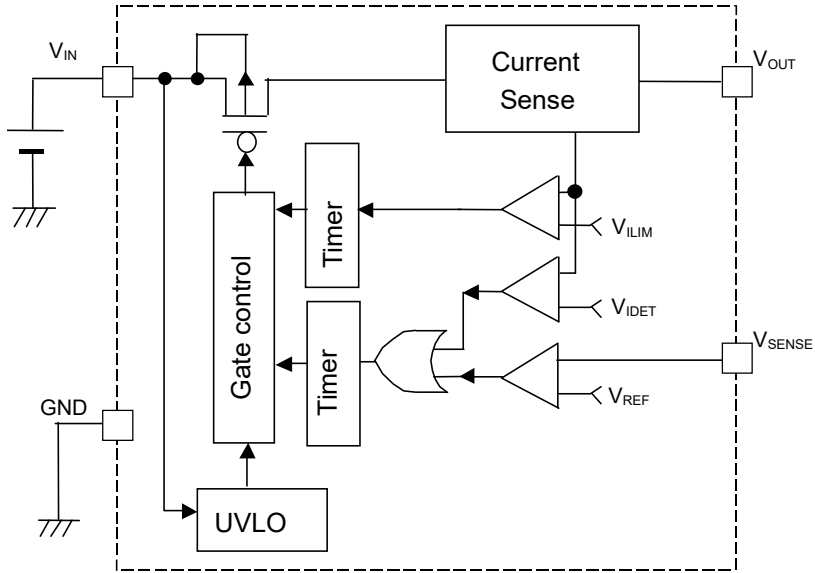

SELECTION GUIDE

Product Name	Package	Quantity per Reel	Pb Free	Halogen Free
R5550K001A-TR	DFN(PL)1010-4F	10,000 pcs	Yes	Yes

001: Designation of current limit threshold, output current limit and protection delay time

Current Limit Threshold: 300mA

Output Current Limit: 1000mA

Protection Delay Time: Refer to Table 1 below.

Table 1. Protection Delay Time

Setting No.	Delay Time	Protection Delay Time		
		Dead-time [ms]	Off-time [ms]	On-time [ms]
001	Current Limit Threshold/ SENSE Pin Voltage	10	80	2.5
	Output Current Limit	1.33	80	1.33

As for Dead-time, OFF-time and ON-time, refer to *Theory of Operation*.

A : Designation of version

Automatic recovery type protection, Voltage SENSE pin

R5550K

NO.EA-292-201202

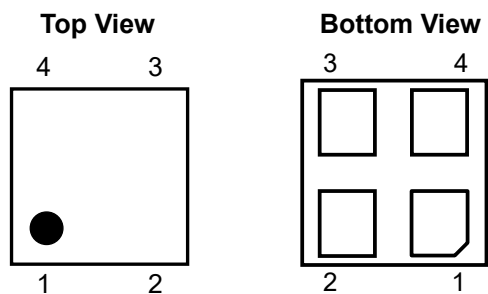
PIN DESCRIPTION**DFN(PL)1010-4F****R5550K001A**

Pin No.	Symbol	Description
1	GND	Ground Pin
2	V_{SENSE}	Voltage SENSE Pin
3	V_{IN}	Input Pin
4	V_{OUT}	Output Pin

ABSOLUTE MAXIMUM RATINGS

Symbol	Item	Rating	Unit
V_{IN}	Input Voltage	-0.3 to 6.0	V
V_{SENSE}	SENSE Pin Voltage	-0.3 to 6.0	V
V_{OUT}	Output Voltage	-0.3 to $V_{IN} + 0.3$	V
I_{OUT}	Output Current	1000	mA
P_D	Power Dissipation (Standard Land Pattern) ^{*1}	300	mW
T_a	Operating Temperature Range	-40 to +85	°C
T_{stg}	Storage Temperature Range	-55 to +125	°C

^{*1} For more information about Power Dissipation and Standard Land Pattern, please refer to *POWER DISSIPATION*.

ABSOLUTE MAXIMUM RATINGS

Electronic and mechanical stress momentarily exceeded absolute maximum ratings may cause the permanent damages and may degrade the lifetime and safety for both device and system using the device in the field. The functional operation at or over these absolute maximum ratings is not assured.

RECOMMENDED OPERATING CONDITIONS (ELECTRICAL CHARACTERISTICS)

All of electronic equipment should be designed that the mounted semiconductor devices operate within the recommended operating conditions. The semiconductor devices cannot operate normally over the recommended operating conditions, even if when they are used over such conditions by momentary electronic noise or surge. And the semiconductor devices may receive serious damage when they continue to operate over the recommended operating conditions.

R5550K

NO.EA-292-201202

ELECTRICAL CHARACTERISTICS $V_{IN}=3.7V$, $I_{OUT}=1mA$, $C_{IN}=0.1\mu F$, $C_{OUT}=\text{none}$, unless otherwise noted.The specifications surrounded by are guaranteed by Design Engineering at $-40^{\circ}C \leq T_a \leq 85^{\circ}C$.**R5550K001A**

(Ta=25°C)

Symbol	Item	Conditions	Min.	Typ.	Max.	Unit
V_{IN}	Input Voltage		2.3		5.25	V
R_{ON}	Switch On Resistance	$I_{OUT}=100mA^{*1}$, $V_{IN}=3.3V$		180		mΩ
I_{OUT}	Output Current		1000			mA
I_{SS}	Supply Current	$I_{OUT}=0mA$, $V_{SENSE}=2.0V$		2.6	15	μA
I_{DET}	Current Limit Threshold ^{*3}		300	460	624	mA
I_{LIM}	Output Current Limit ^{*3}	Initial Saturation Region ^{*4}	1130	1470	1790	mA
I_{SC}	Short Current Limit	$V_{OUT}=0V$		300		mA
V_{DET}	SENSE Pin Detector Threshold	V_{SENSE} falling	x 0.97	0.5	x 1.03	V
V_{HYS}	SENSE Pin Hysteresis	V_{SENSE} rising	0.63	0.9	1.2	V
T_{DET1}	Dead-time 1	$V_{SENSE} \leq V_{DET}$ OR $I_{DET} \leq I_{OUT} < I_{LIM}$	x 0.72	10	x 1.32	ms
T_{OFF1}	OFF-time 1		x 0.71	80	x 1.34	ms
T_{ON1}	ON-time 1		x 0.72	2.5	x 1.35	ms
T_{DET2}	Dead-time 2	$V_{OUT}=0V$ or $I_{OUT} > I_{LIM}$	x 0.65	1.33	x 1.35	ms
T_{OFF2}	OFF-time 2		x 0.65	80	x 1.35	ms
T_{ON2}	ON-time 2		x 0.65	1.33	x 1.35	ms
T_r	Start-up Time	$V_{OUT}=10\%$ to 90% , $C_{OUT}=0.1\mu F$		12		μs
T_{rdelay}	Start-up Delay Time	" $V_{IN}=V_{UVLO}$ " to " $V_{OUT}=10\%$ "		60		μs
T_{SC}	Short Current Response Time ^{*2}	$V_{OUT}=0V$		4		μs
V_{UVLO}	UVLO Release Voltage	V_{IN} rising	2.0	2.1	2.2	V
V_{HYSUV}	UVLO Hysteresis	V_{IN} falling		0.2		V

All test items listed under *ELECTRICAL CHARACTERISTICS* are done under the pulse load condition ($T_j \approx T_a = 25^{\circ}C$) except Start-up Time, Start-up Delay Time, Short Current Response Time, Dead-time 2, OFF-time 2 and ON-time 2.

^{*1} As for R_{ON} when $I_{OUT} > 100mA$, refer to 12) *Switch ON Resistance vs. Output Current* of *TYPICAL CHARACTERISTICS*.

^{*2} Refer to 36) *Short-Protection-Circuit Transient Response* of *TYPICAL CHARACTERISTICS*.

^{*3} Each set value should be "Max. $I_{DET} < \text{Min. } I_{LIM}$ ". Note: Do not use with $I_{DET}=400mA$ and $I_{LIM}=500mA$.

^{*4} I_{LIM} could be influenced by the measurement time. All products were tested within the initial saturation region as shown in the following page.

R5550KxxxA

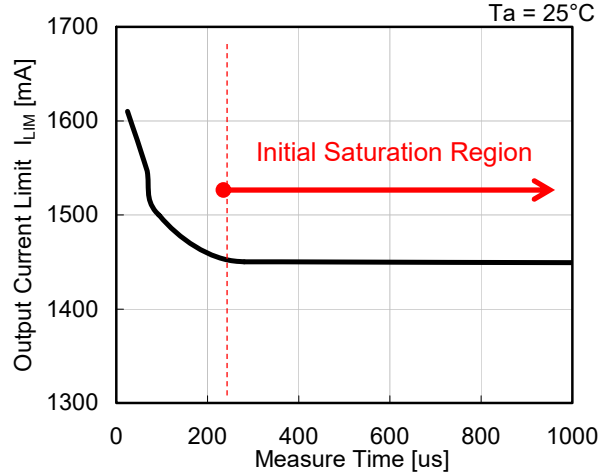
 $I_{LIM_SET} = 1000\text{mA}$ $T_a = 25^\circ\text{C}$ **Measurement Board Information**

- Board Size: 27.5mm x 40.0mm
- IC Mounting Position: Center of the board
- Board Material: Glass Cloth Epoxy Plastic (Single layer)
- Board Thickness: 1.6mm
- Diameter of Through-hole: 1.0mm
- Number of Through-holes: 12

THEORY OF OPERATION

Operation Example: R5550K001A with Automatic Recovery Protection and Voltage SENSE Pin

[1] Operation of Current Limit Detector Threshold (I_{DET})

If I_{OUT} exceeds I_{DET} , Timer 1 starts to operate and the switch turns off after Dead-time 1. After OFF-time 1, the switch automatically turns on. If $I_{OUT} \geq I_{DET}$ continues, the switch turns off again after ON-time 1. Afterwards, the switch repeats intermittent operation. If $I_{OUT} < I_{DET}$, the IC recognizes it as back in normal operation and start to output as usual.

Even if $I_{OUT} < I_{DET}$ during OFF-time1, the switch automatically turns on after OFF-time 1.

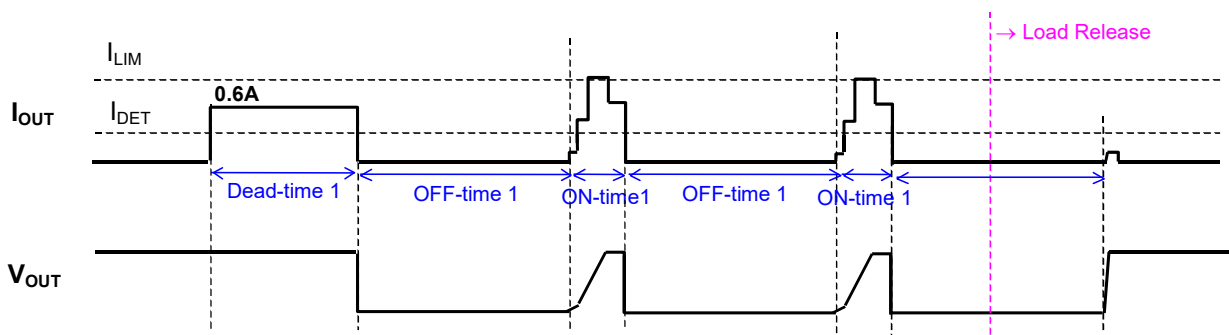

[2] Operation of Output Current Limit (I_{LIM})

If I_{OUT} exceeds I_{LIM} (including output short-circuit), I_{OUT} becomes limited by I_{LIM} or I_{sc} . So, Timer 2 starts to operate and the switch turns off after Dead-time 2.

After OFF-time 2, the switch automatically turns on. If $I_{OUT} \geq I_{LIM}$ or short current condition continues, the switch turns off again after ON-time 2. Afterwards, I_{OUT} the switch repeats intermittent operation. If $I_{OUT} < I_{LIM}$, the IC recognizes it as back in normal operation and start to output as usual.

Even if $I_{OUT} < I_{LIM}$ during OFF-time2, the switch automatically turns on after OFF-time 2.

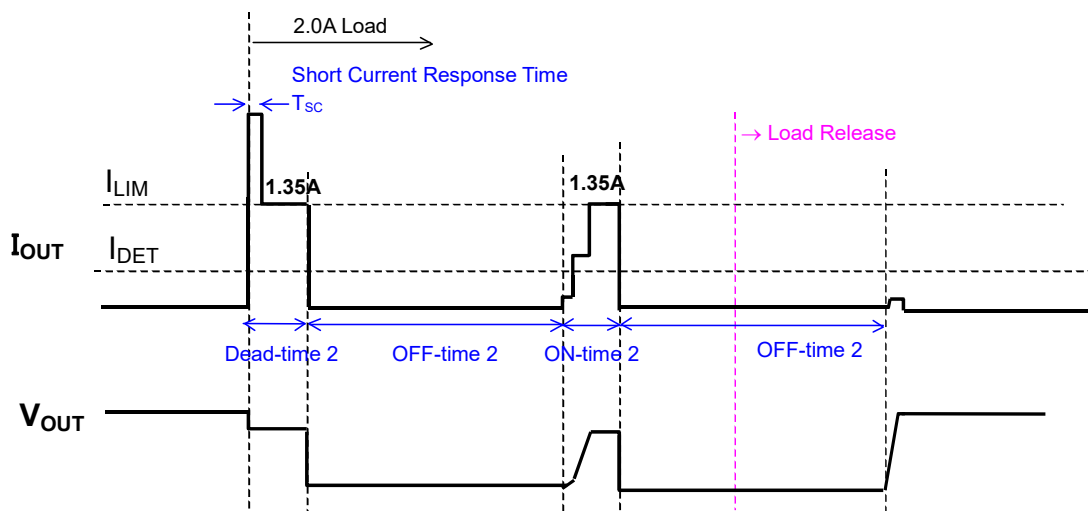

[3] Operation of SENSE Pin Voltage (V_{SENSE})

If V_{SENSE} falls below V_{DET} , Timer 1 starts to operate and the switch turns off after Dead-time 1. After OFF-time 1, the switch automatically turns on. If $V_{SENSE} \leq V_{DET}$ continues, the switch turns off again after ON-time 1. Afterwards, I_{OUT} repeats intermittent operation.

If $V_{SENSE} > (V_{DET} + V_{HYS})$, when the switch is automatically turning on after OFF-time 1, the IC recognizes it as back in normal operation and start to output as usual.

Even if $V_{SENSE} > (V_{DET} + V_{HYS})$ during OFF-time 1, the switch automatically turns on after OFF-time 1.

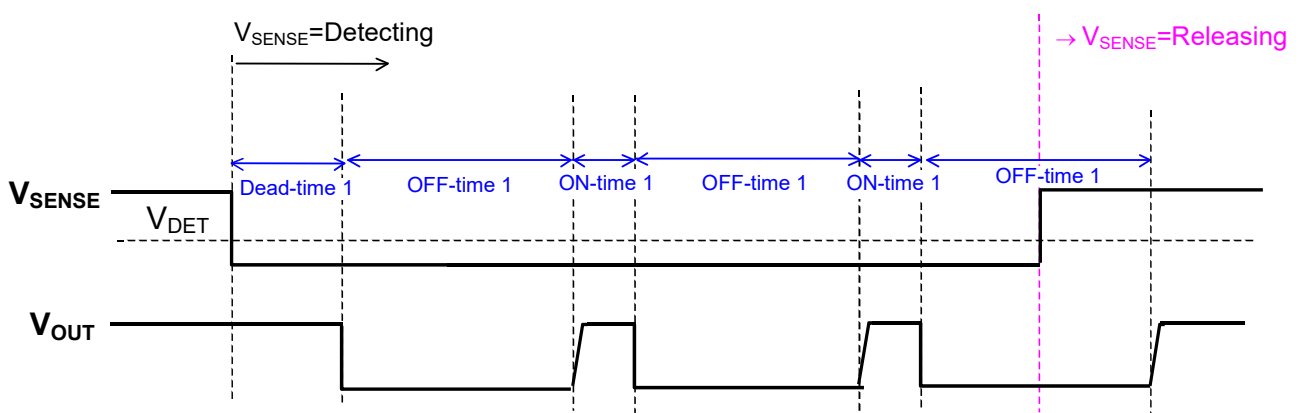

R5550KNO.EA-292-201202

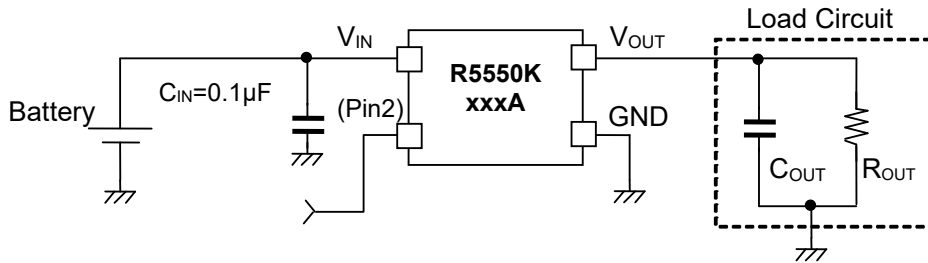
TYPICAL APPLICATIONS AND TECHNICAL NOTES**Typical Application****Technical Notes**

The R5550K does not require any bypass capacitor between VIN and GND. However, it is recommended that a 0.1µF or more capacitor be connected between VIN and GND. Especially, if there's any possibility of generating spike noise due to the parasitic element (inductance) of VIN, connect a proper size capacitor between VIN and GND.

POWER DISSIPATION (DFN(PL)1010-4F)

Power Dissipation (P_D) depends on conditions of mounting on board. This specification is based on the measurement conditions below.

Measurement Conditions

	Standard Land Pattern
Environment	Mounting on Board (Wind Velocity=0m/s)
Board Material	Glass Cloth Epoxy Plastic (Double-sided)
Board Dimensions	40mm x 40mm x 1.6mm
Copper Ratio	Topside: Approx. 50%, Backside: Approx. 50%
Through-holes	ϕ 0.54mm x 24pcs

Measurement Result:

($T_a=25^\circ\text{C}$, $T_{j\text{max}}=125^\circ\text{C}$)

	Standard Land Pattern
Power Dissipation	300mW
Thermal Resistance	$\theta_{ja} = (125-25^\circ\text{C})/0.3\text{W} = 330^\circ\text{C/W}$
	$\theta_{jc} = 48^\circ\text{C/W}$

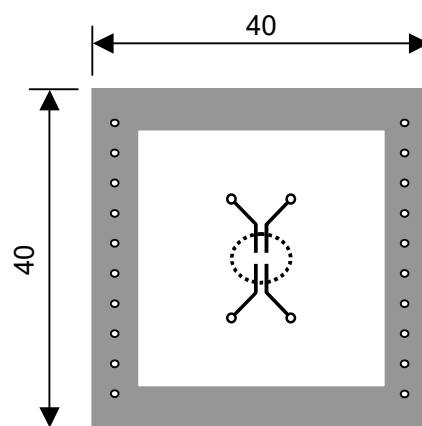
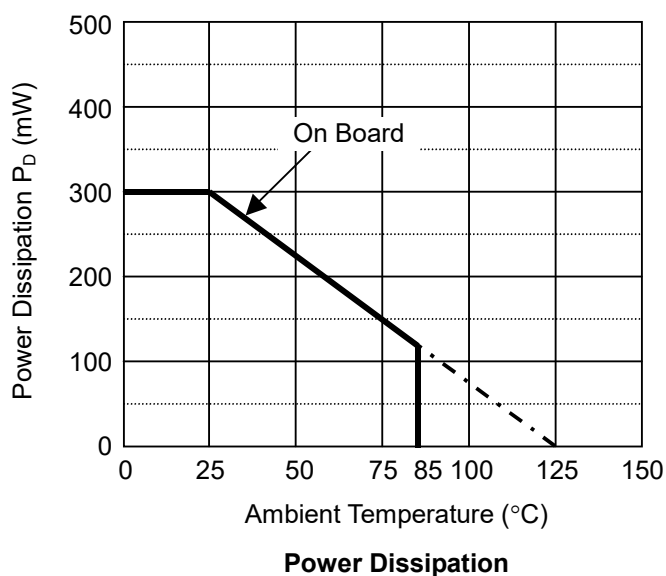

Measurement Board Pattern

 IC Mount Area (Unit : mm)

R5550K

NO.EA-292-201202

TYPICAL CHARACTERISTICS

1) Output Voltage vs. Output Current

R5550K001A

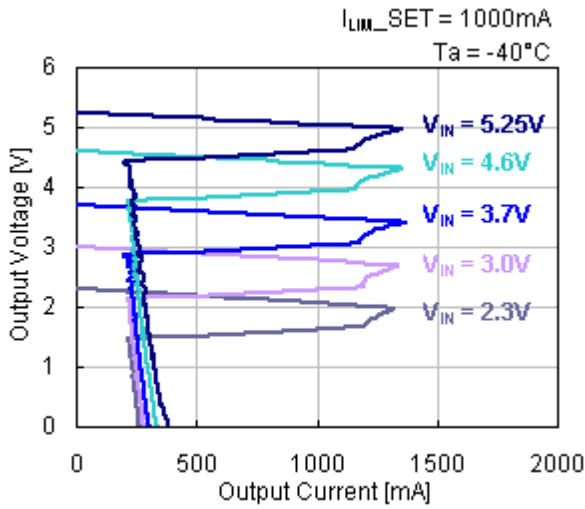

R5550K001A

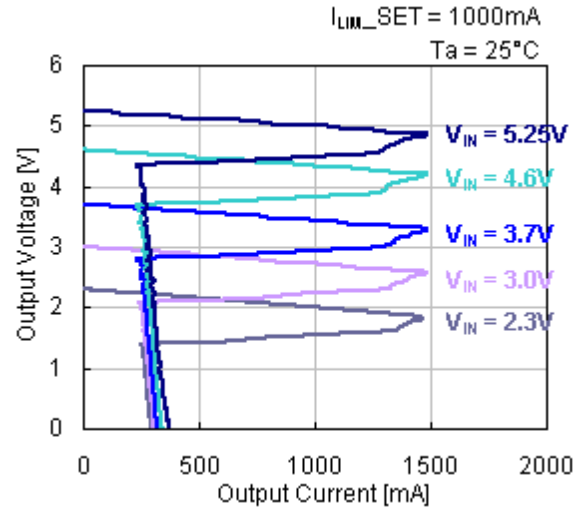

R5550K001A

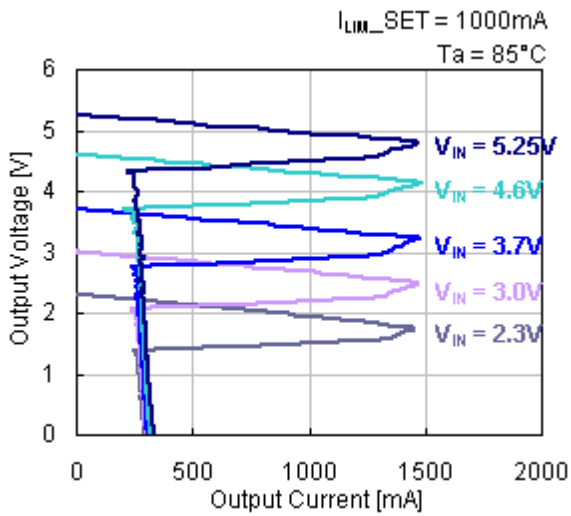

2) Current Limit vs. Temperature

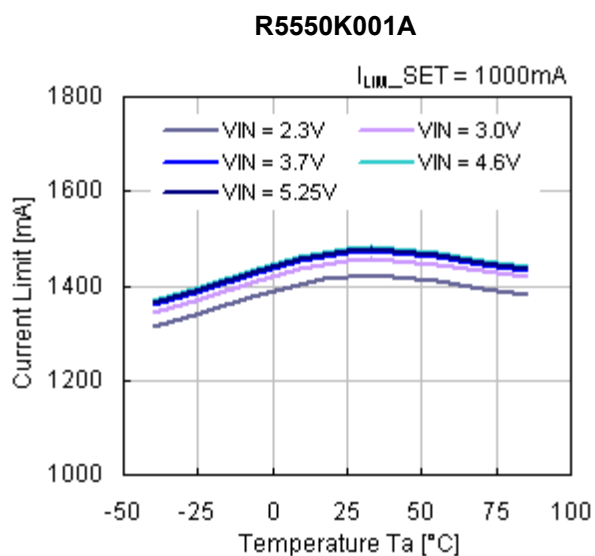

3) Current Limit vs. Input Voltage

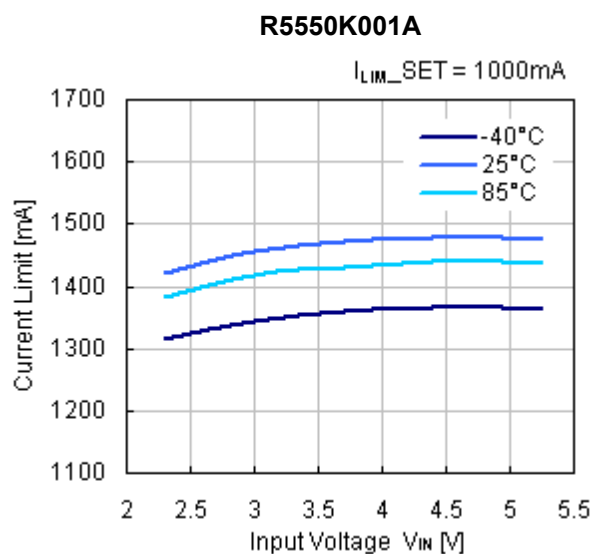

4) Output Current Detector Threshold vs. Temperature

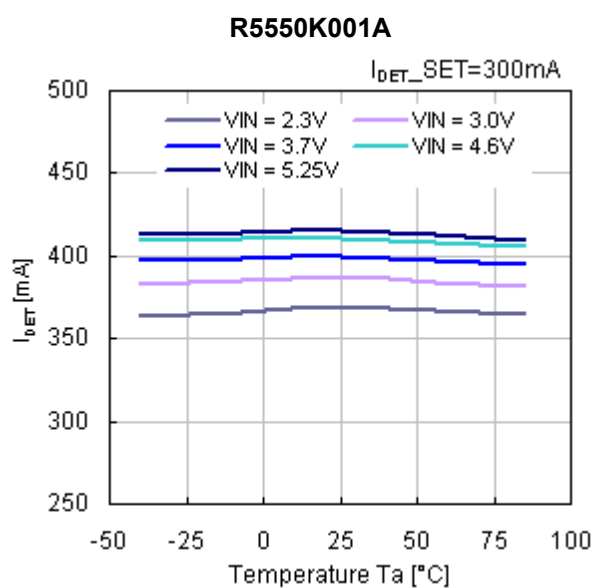

5) Output Current Detector Threshold vs. Input Voltage

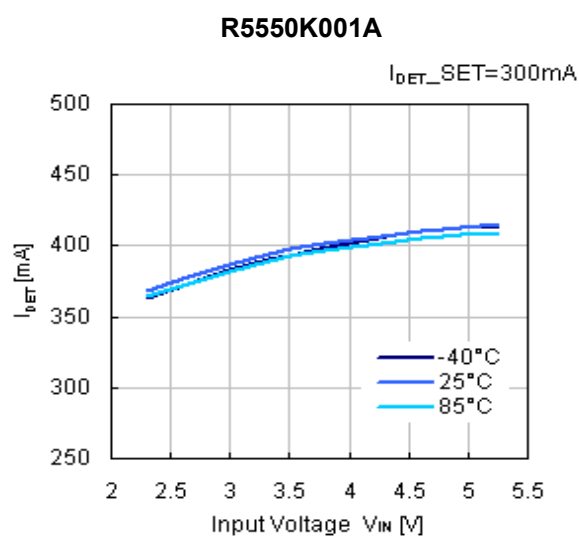

R5550K

NO.EA-292-201202

6) Short Current Limit vs. Temperature

R5550K001A

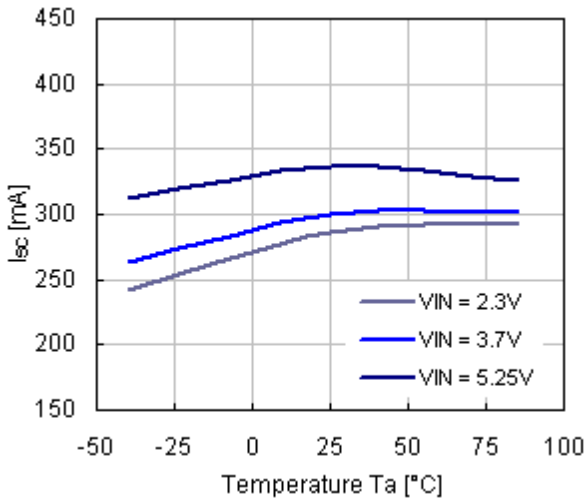

7) Short Current Limit vs. Input Voltage

R5550K001A

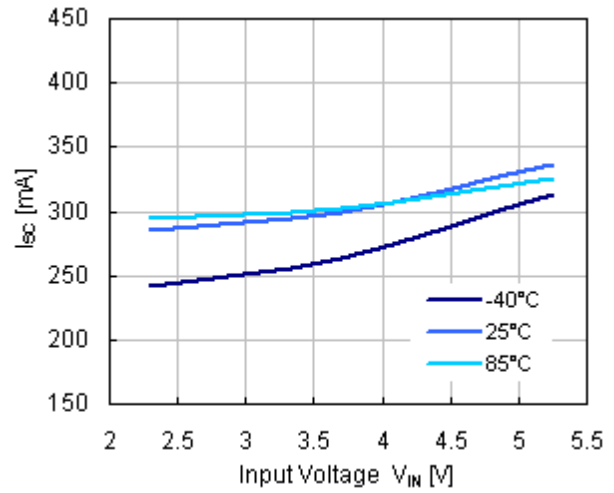

8) Supply Current Limit vs. Input Voltage

R5550K001A

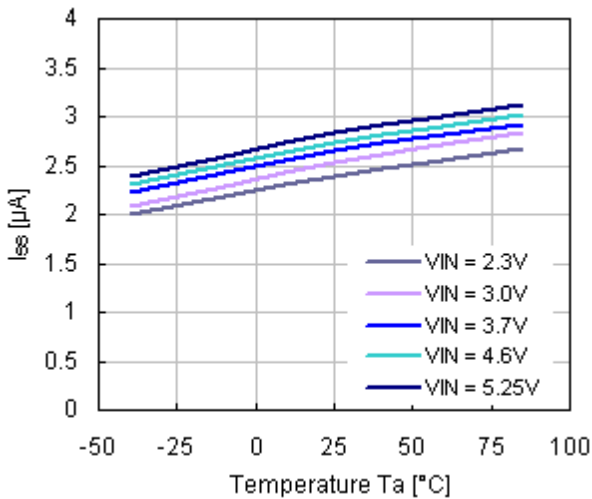

9) Supply Current vs. Input Voltage

R5550K001A

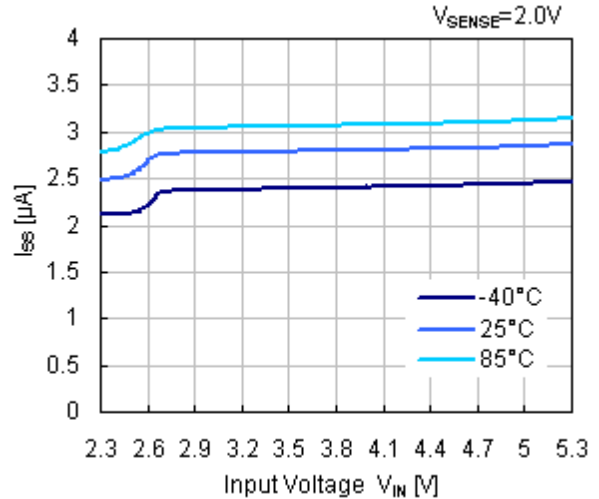

10) Switch ON Resistance vs. Temperature

R5550K001A

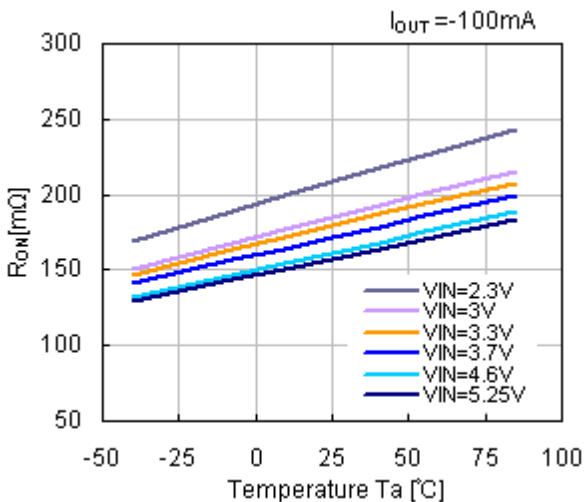

11) Switch ON Resistance vs. Input Voltage

R5550K001A

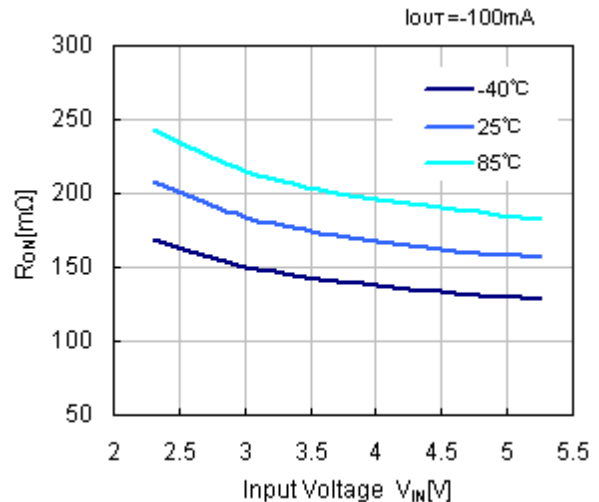

12) Switch ON Resistance vs. Output Current

R5550K001A

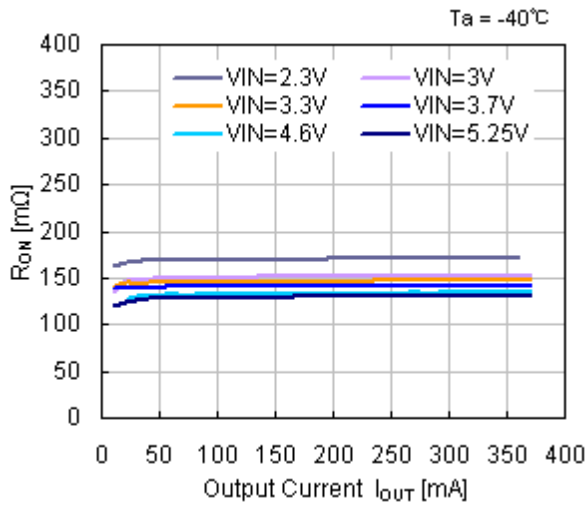

R5550K001A

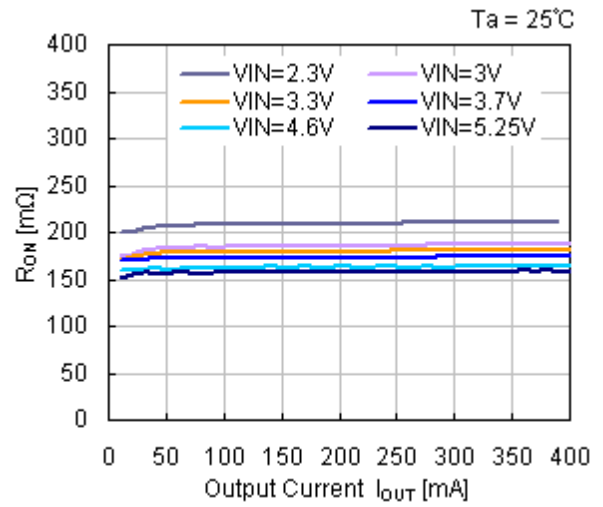

R5550K001A

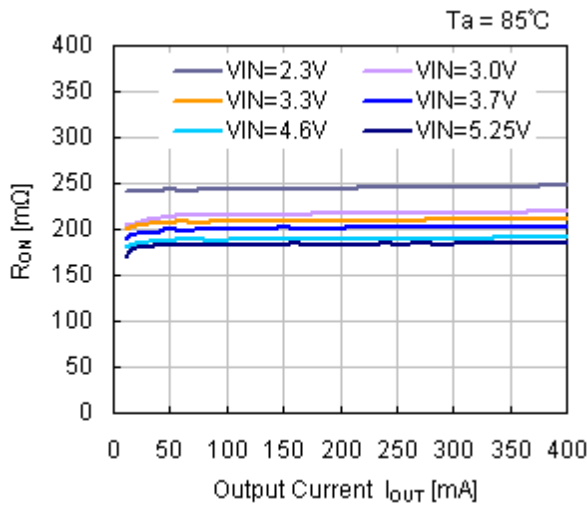

R5550K

NO.EA-292-201202

13) Inrush Current vs. Output Capacitor ($C_{IN}=NONE$)

R5550K001A

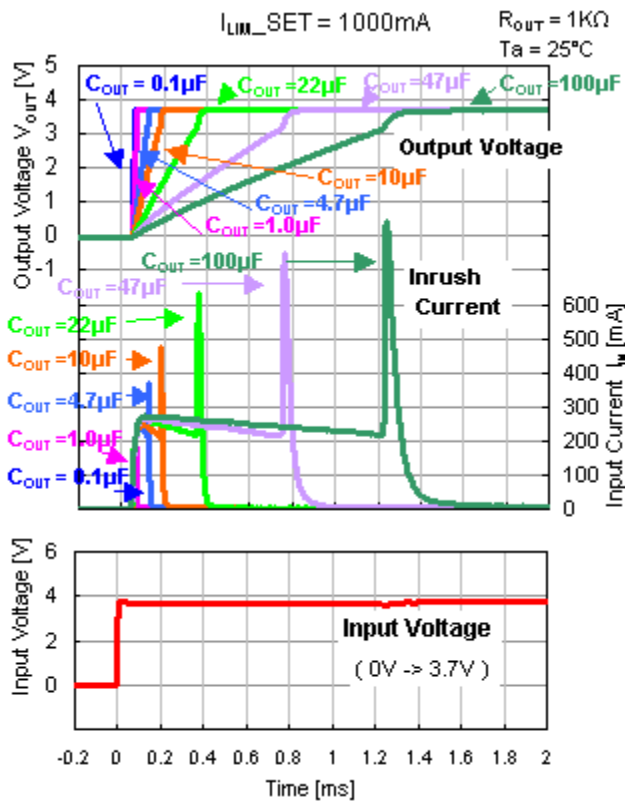

14) Inrush Current vs. Output Capacitor ($C_{IN}=NONE$, $C_{OUT}=1\mu F$)

R5550K001A

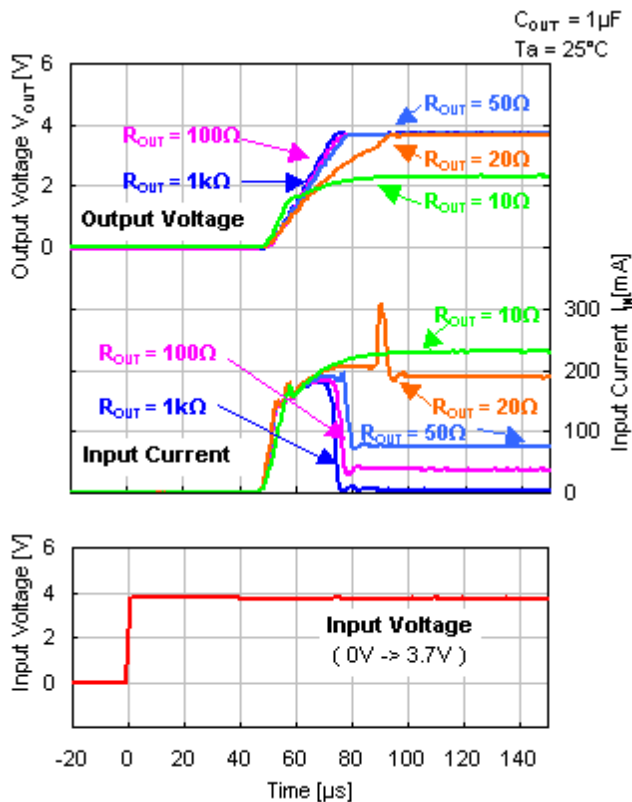

15) Output Rise Time vs. Input Voltage
R5550K001A

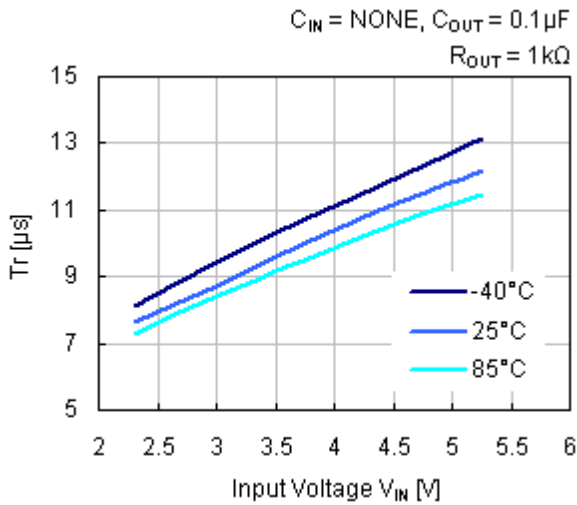

16) Output Delay Time vs. Input Voltage
R5550K001A

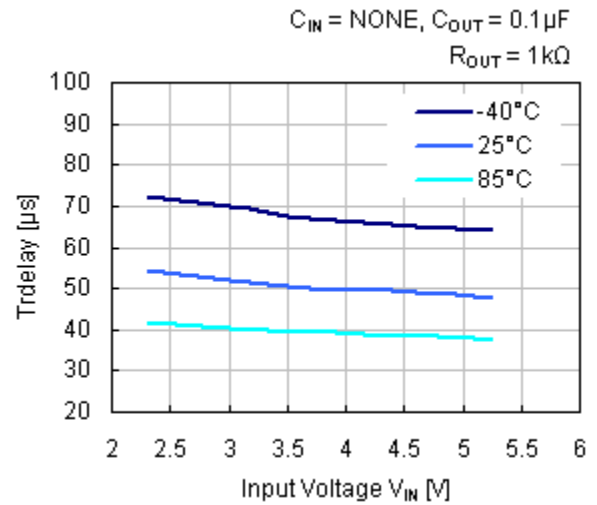

17) Output Rise Time + Output Delay Time vs. Input Voltage
R5550K001A

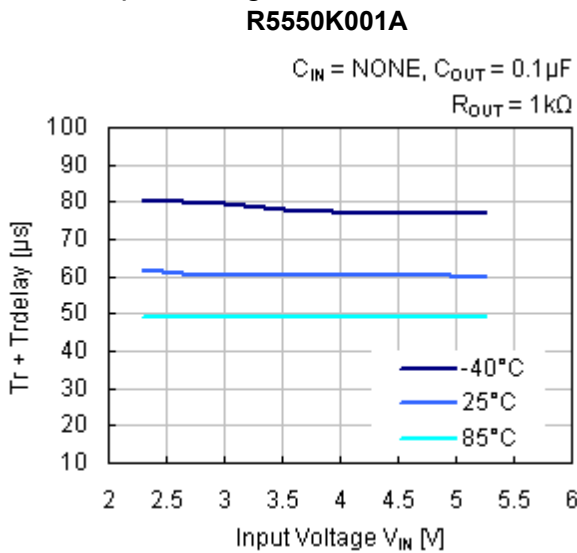

18) V_{SENSE} Detector Threshold vs. Temperature
R5550K001A

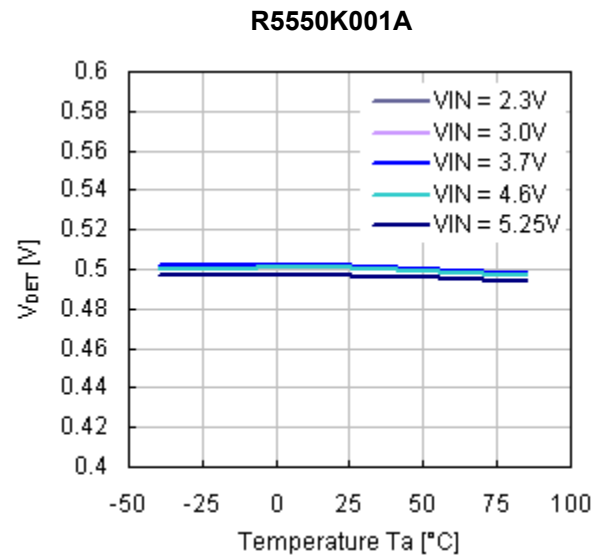

19) V_{SENSE} Released Voltage vs. Temperature
R5550K001A

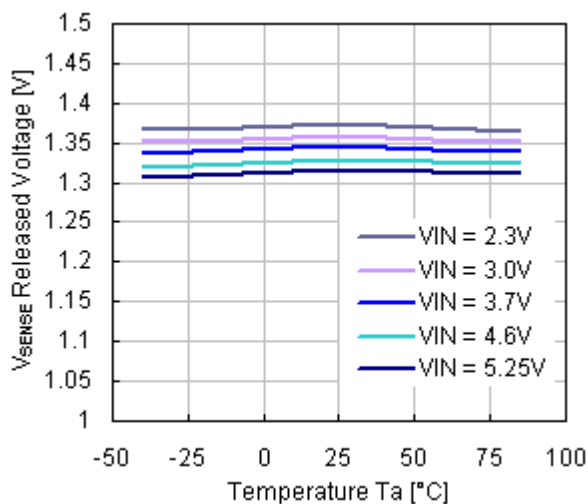

20) V_{SENSE} Hysteresis vs. Temperature
R5550K001A

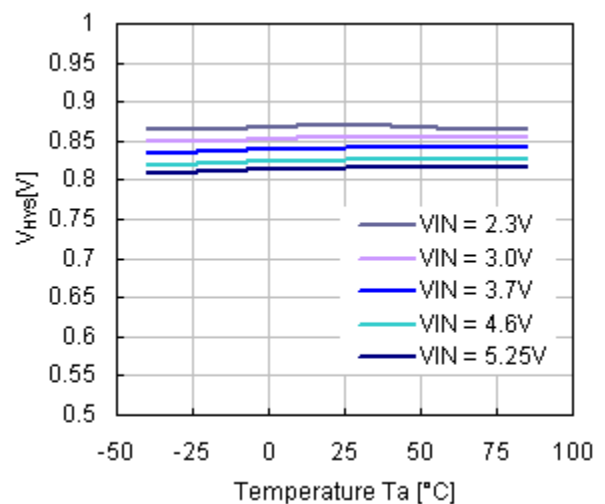

R5550K

NO.EA-292-201202

21) V_{SENSE} Detector Threshold vs. Input Voltage 22) V_{SENSE} Released Voltage vs. Input Voltage

R5550K001A

R5550K001A

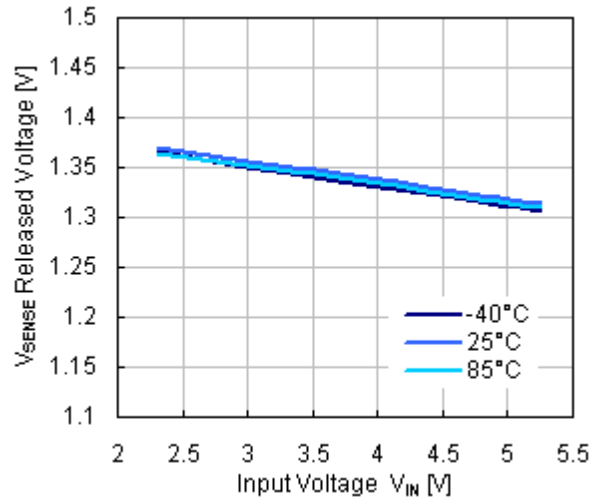
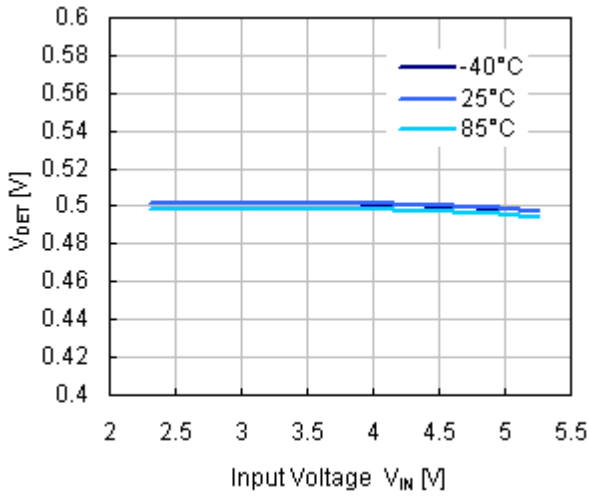

23) V_{SENSE} Hysterisis vs. Input Voltage

R5550K001A

24) UVLO Released Voltage vs. Temperature

R5550K001A

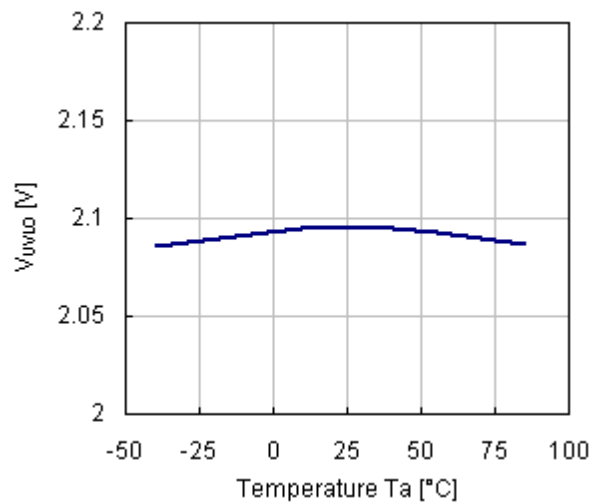
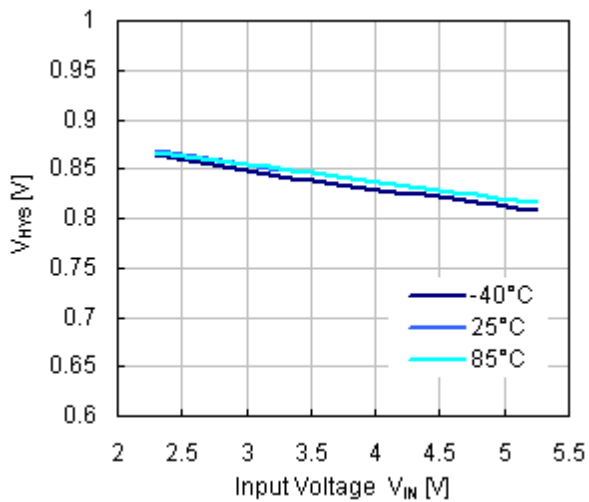

25) UVLO Hysterisis vs. Temperature

R5550K001A

26) Supply Current at UVLO Detected vs. Temperature

R5550K001A

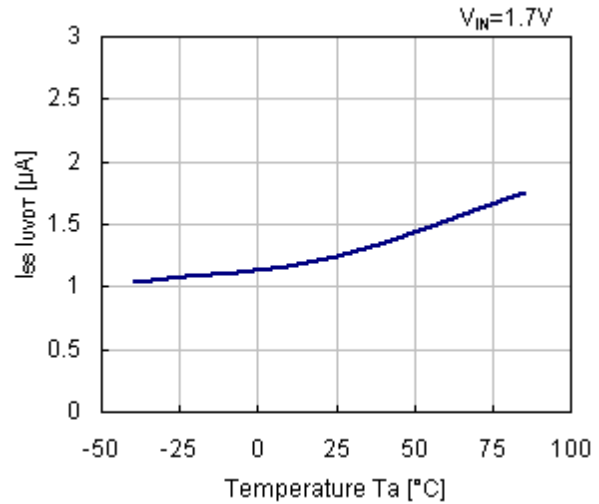
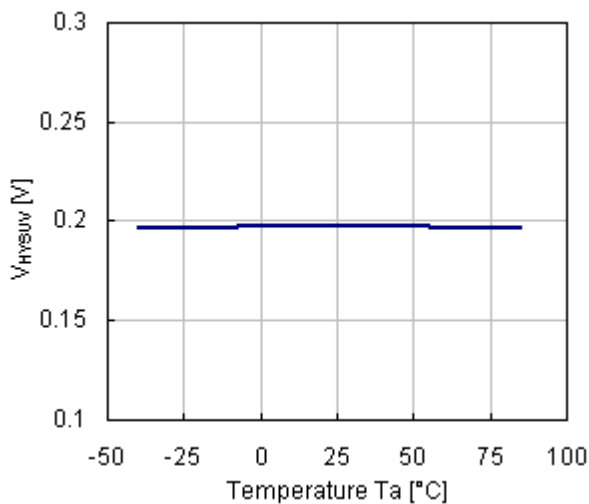

27) Limit Ignoring Time1 vs. Temperature

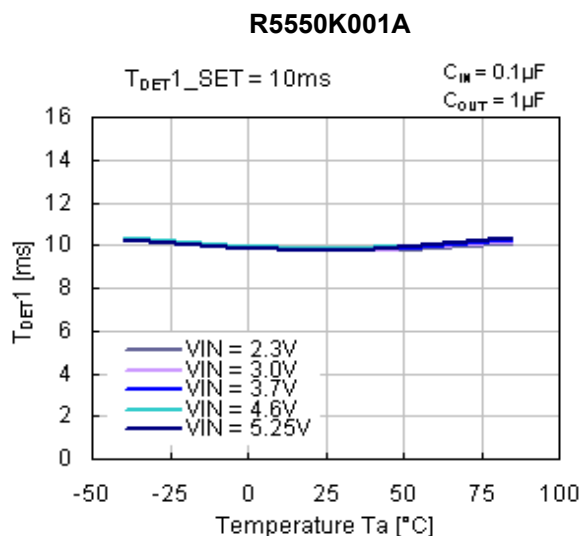

28) Limit Ignoring Time1 vs. Input Voltage

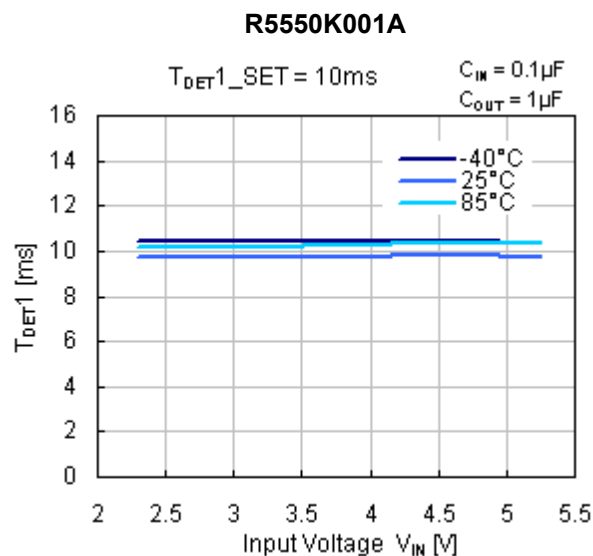

29) Limit Ignoring Time 2 vs. Temperature

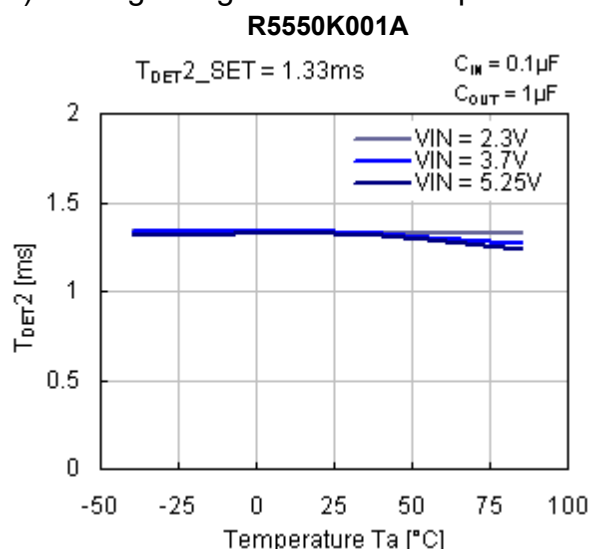

30) Limit Ignoring Time2 vs. Input Voltage

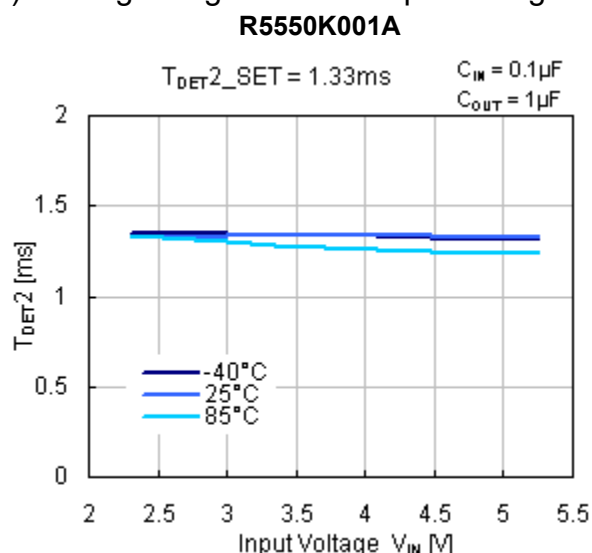

31) OFF Time1 vs. Temperature

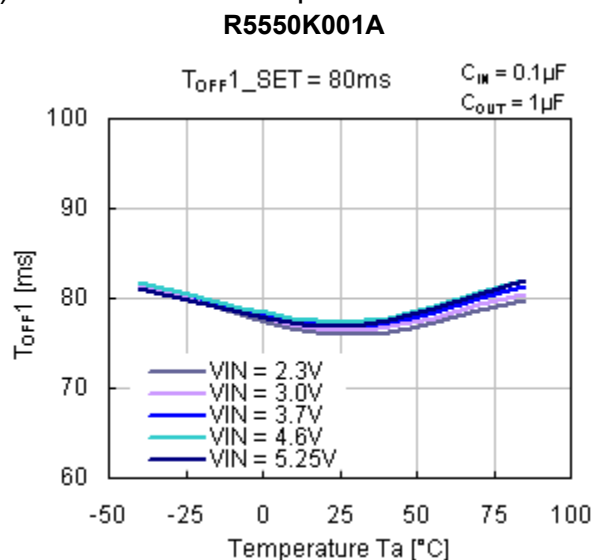

32) ON Time1 vs. Temperature

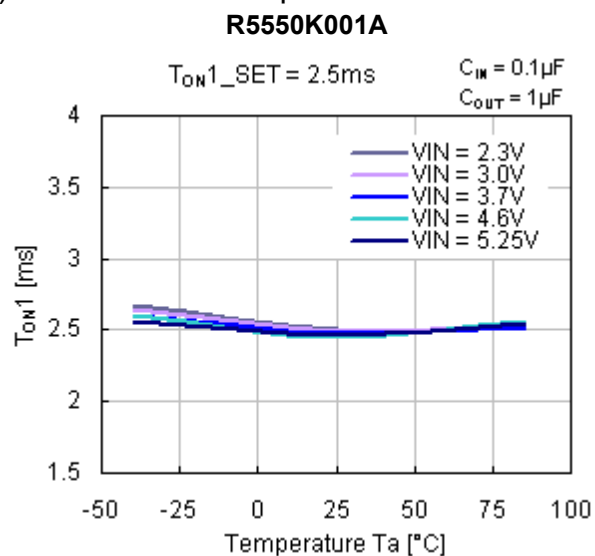

R5550K

NO.EA-292-201202

33) OFF Time2 vs. Temperature
R5550K001A

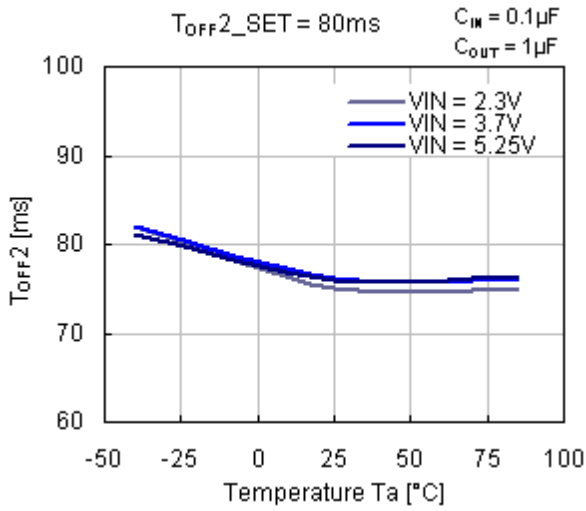

34) ON Time2 vs. Temperature
R5550K001A

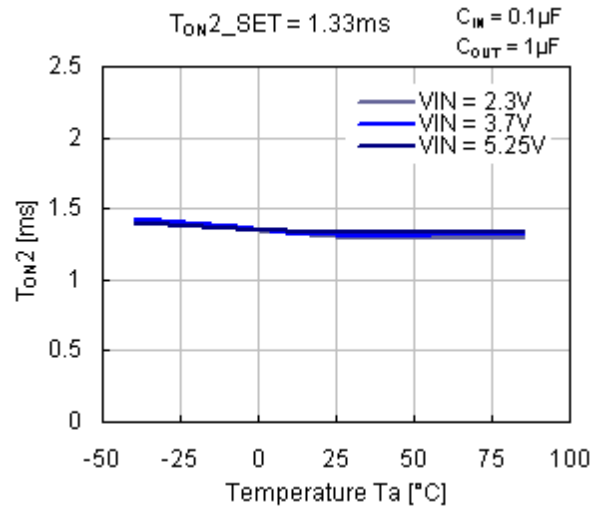

35) Operation Waveform with SENSE Pin
R5550K001A

$T_{DET1_SET} = 10\text{ms}$
 $T_{OFF1_SET} = 80\text{ms}$
 $T_{ON1_SET} = 2.5\text{ms}$

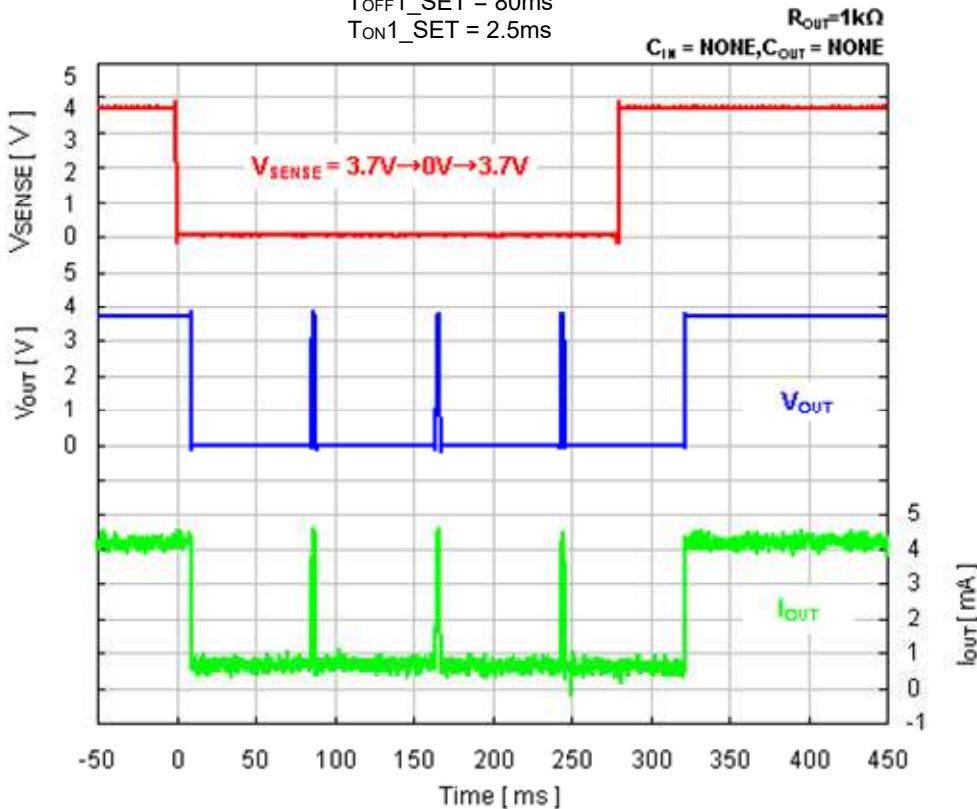

36) Short-Protection-Circuit Transient Response

R5550K001A

$V_{IN} = 3.7V, T_a = 25^{\circ}C$
 $C_{IN} = 1\mu F, C_{OUT} = NONE$

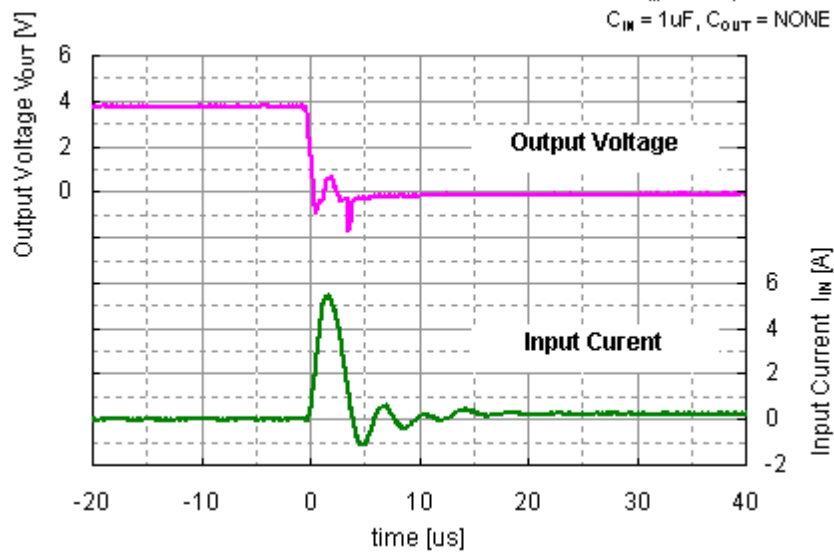



1. The products and the product specifications described in this document are subject to change or discontinuation of production without notice for reasons such as improvement. Therefore, before deciding to use the products, please refer to our sales representatives for the latest information thereon.
2. The materials in this document may not be copied or otherwise reproduced in whole or in part without prior written consent of our company.
3. Please be sure to take any necessary formalities under relevant laws or regulations before exporting or otherwise taking out of your country the products or the technical information described herein.
4. The technical information described in this document shows typical characteristics of and example application circuits for the products. The release of such information is not to be construed as a warranty of or a grant of license under our company's or any third party's intellectual property rights or any other rights.
5. The products listed in this document are intended and designed for use as general electronic components in standard applications (office equipment, telecommunication equipment, measuring instruments, consumer electronic products, amusement equipment etc.). Those customers intending to use a product in an application requiring extreme quality and reliability, for example, in a highly specific application where the failure or misoperation of the product could result in human injury or death (aircraft, spacevehicle, nuclear reactor control system, traffic control system, automotive and transportation equipment, combustion equipment, safety devices, life support system etc.) should first contact us.
6. We are making our continuous effort to improve the quality and reliability of our products, but semiconductor products are likely to fail with certain probability. In order to prevent any injury to persons or damages to property resulting from such failure, customers should be careful enough to incorporate safety measures in their design, such as redundancy feature, fire containment feature and fail-safe feature. We do not assume any liability or responsibility for any loss or damage arising from misuse or inappropriate use of the products.
7. Anti-radiation design is not implemented in the products described in this document.
8. The X-ray exposure can influence functions and characteristics of the products. Confirm the product functions and characteristics in the evaluation stage.
9. WLCSP products should be used in light shielded environments. The light exposure can influence functions and characteristics of the products under operation or storage.
10. There can be variation in the marking when different AOI (Automated Optical Inspection) equipment is used. In the case of recognizing the marking characteristic with AOI, please contact our sales or our distributor before attempting to use AOI.
11. Please contact our sales representatives should you have any questions or comments concerning the products or the technical information.



Nisshinbo Micro Devices Inc.

Official website

<https://www.nisshinbo-microdevices.co.jp/en/>

Purchase information

<https://www.nisshinbo-microdevices.co.jp/en/buy/>

