

REV.	DESCRIPTION	DATE	APPROVED
A	Engineering Release	08/27/14	J. C.
B	Engineering Update w/o Changes	05/21/16	J. C.

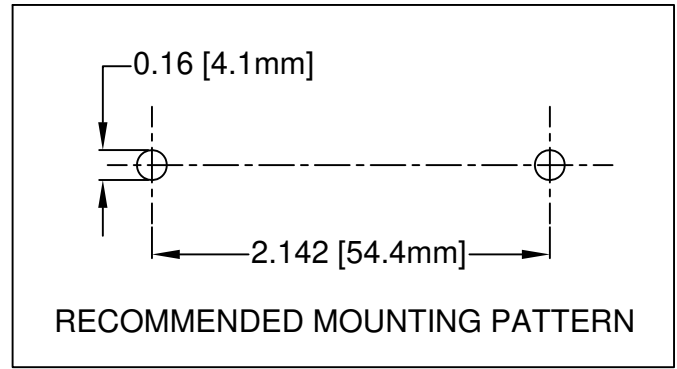
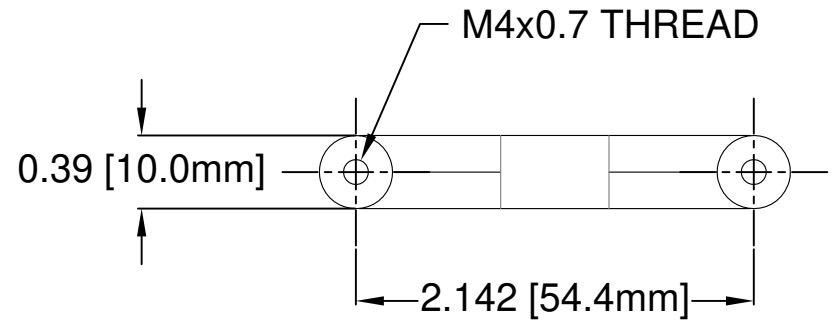
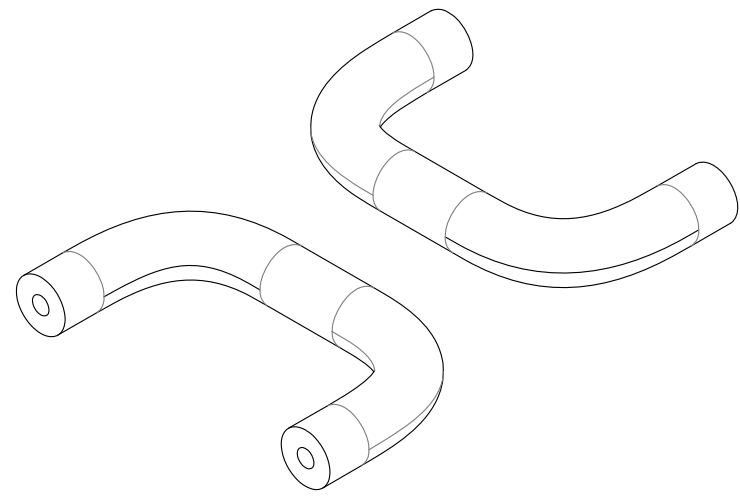
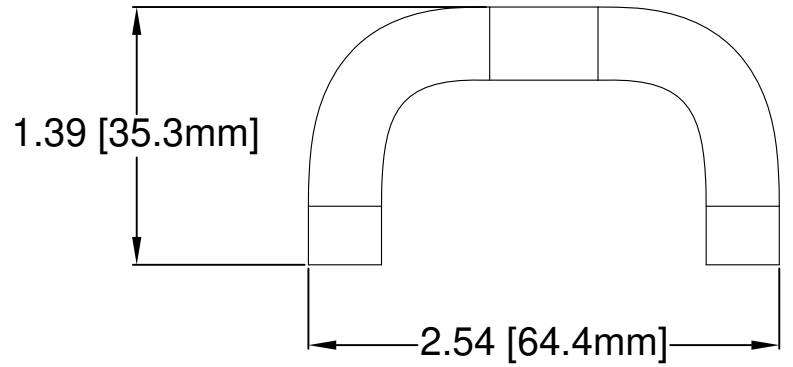
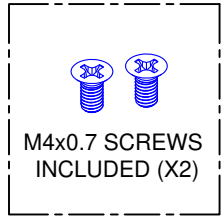

NOTES:
 2. MOUNTING HARDWARE SHIPPED UNASSEMBLED
 1. MATERIAL: ALUMINUM

STANDARD TOLERANCE (UNLESS OTHERWISE SPECIFIED)		 4 THOMAS, IRVINE, CA. 92618 TEL: (949) 951-8808 FAX: (949) 951-3974	
DECIMALS	ANGULAR		
.X ± .1	X° ± 1°		TITLE: 2U SUBRACK HANDLE, ROUND
.XX ± .02			DESIGNED: A. Wright
.XXX ± .010		CHECKED: B. Oliver	DATE: 08/27/14
		PART NO: SRH-2RUR	REVISION: B
		CAGE CODE : 32559	SHEET # 1 OF 1
CAD GENERATED DOCUMENT. DO NOT MEASURE DRAWING.			