

New Product

CN-0310

GP01 Series

Ultra-Miniature Size Ideal for High Density Mounting

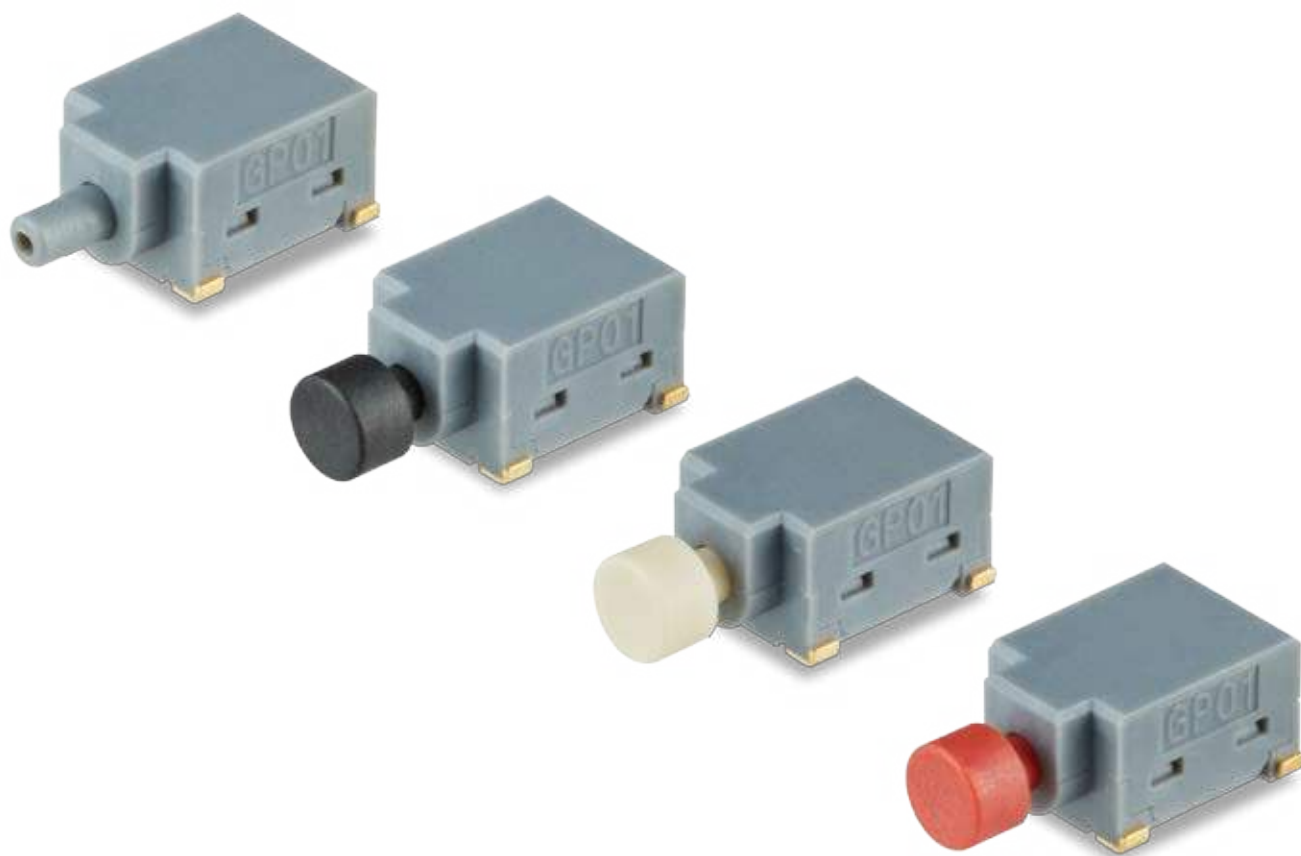

Right Angle SMT Pushbuttons

General Specifications

Electrical Capacity (Resistive Load)

Logic Level: 0.4VA maximum @ 28V AC/DC maximum
(Applicable Range 0.1mA ~ 0.1A @ 20mV ~ 28V)

Other Ratings

Contact Resistance: 80 milliohms maximum
Insulation Resistance: 500 megohms minimum @ 500V DC
Dielectric Strength: 500V AC minimum for 1 minute minimum
Mechanical Life: 40,000 operations minimum
Electrical Life: 40,000 operations minimum
Total Travel: .043" (1.1mm)

Materials & Finishes

Actuator/Plunger: Glass fiber reinforced polyamide
Case: Glass fiber reinforced polyamide
Moveable Contacts: Beryllium copper
Base: Glass fiber reinforced polyamide
Terminals: Brass with gold plating

Environmental Data

Operating Temperature Range: -40°C through +85°C (-40°F through +185°F)

Processing

Soldering: **Manual Soldering:** 390°C maximum for 4 seconds maximum
Reflow Soldering: Preheat temperature: 180°C ~ 200°C; Preheat time: 120 seconds; Heating temperature: 230°C; Heating time: 60 seconds; Peak temperature (surface): 250°C.
Cleaning: These devices are not process sealed. Hand clean locally using alcohol based solution.
 Note: After soldering, use caution to prevent mechanical stress on the terminal area and to avoid warpage of the circuit board.

Distinctive Characteristics

Ultra-miniature size allows high density mounting and utilizes reduced space for surface mounting.

Greaseless condition contributes to resistance of harsh conditions, including wider operating temperatures.

Cap and plunger are one unit, simplifying soldering and cleaning processes and eliminating need to remove and replace the cap. Plunger without cap is an alternate option.

Heat resistant resin used for housing, base and plunger allows vapor phase and infrared convection reflow soldering.

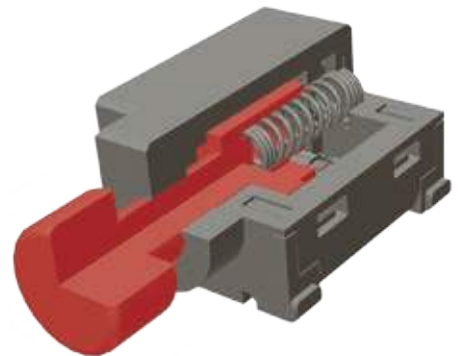

Actual Size

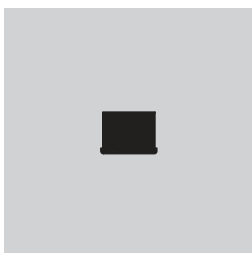

Highly reliable gold plated contacts provide stable contact performance throughout long term use.

J bend terminals lend to easy surface mounting and mechanical stability during soldering and simplified solder joint inspection.

Remarkably precise coplanarity: all considered surfaces lying between two parallel planes are a maximum distance apart of .0039" (0.1mm).

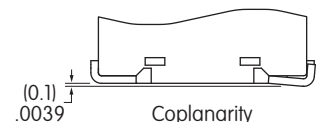

TYPICAL SWITCH ORDERING EXAMPLE

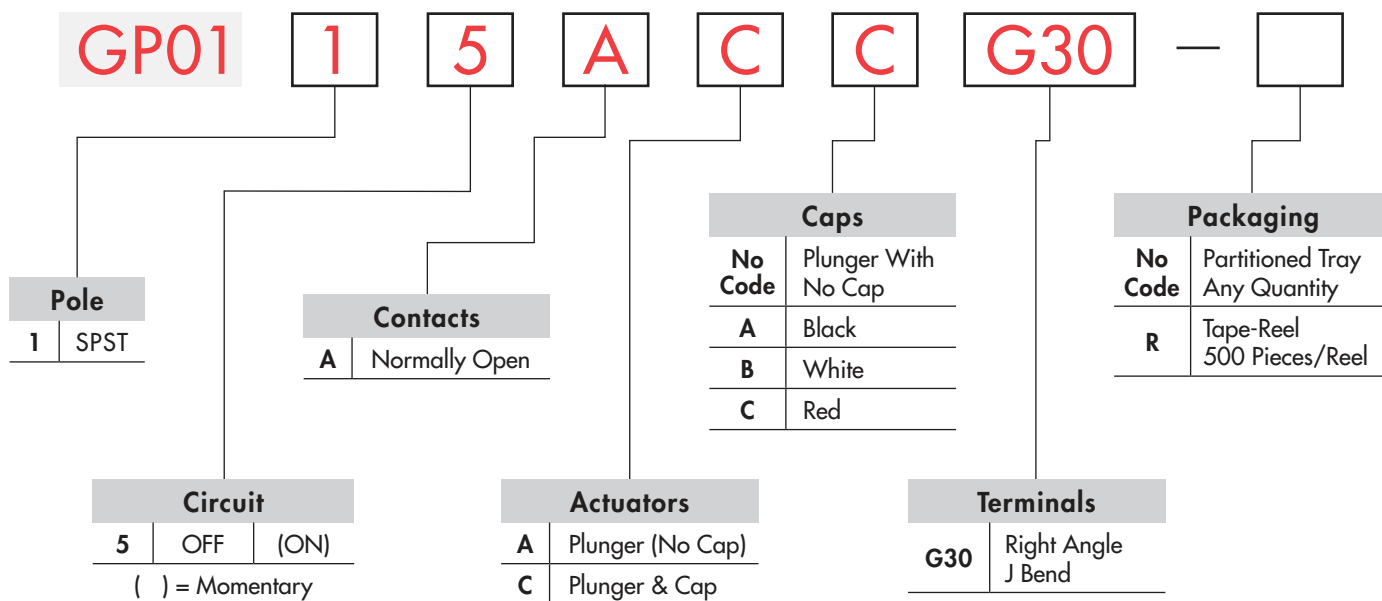

Note: Plunger Actuator (Code A) cannot be combined with Cap.

DESCRIPTION FOR TYPICAL ORDERING EXAMPLE

GP0115ACC30

Packaged in Partitioned Tray or Tape-Reel

Plunger & Cap One Unit



SPST OFF-(ON) Circuit

J Bend Terminals

POLE & CIRCUIT

Pole	Model	Plunger Position () = Momentary		Connected Terminals		Throw & Switch Schematic
		Normal	Down	Normal	Down	
SP	GP0115AA	OFF	(ON)	OFF	1-2	SPST
Pole	Model	Normal	Down	Normal	Down	Note: Terminal numbers are not actually on the switch.
SP	GP0115AC	OFF	(ON)	OFF	1-2	SPST

ACTUATORS

A

Plunger with No Cap

Plunger cannot be combined with cap

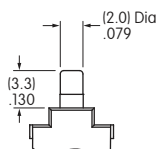

C

Plunger & Cap

Plunger may be combined with cap codes A, B or C

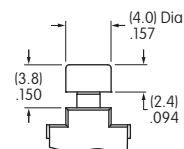

TYPICAL SWITCH DIMENSIONS

Right Angle Mounting

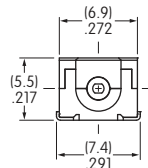
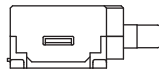

Plunger & No Cap

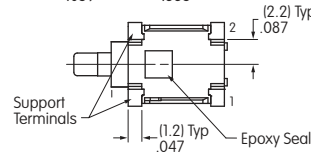
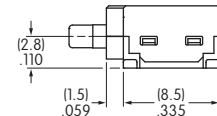
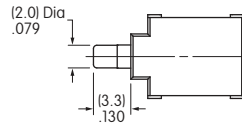

Pad Layout

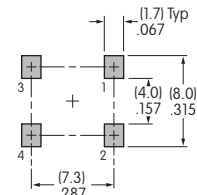

GP0115AAG30

Right Angle Mounting

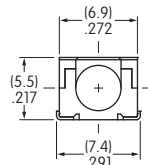
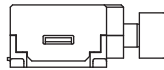

Plunger & Cap

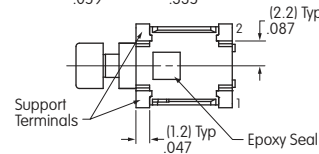
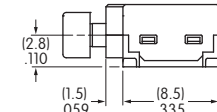
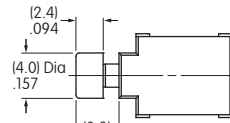

Pad Layout

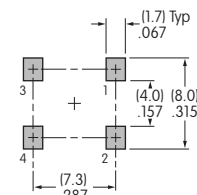

GP0115ACCG30

PACKAGING

Tape-Reel Packaging

No Code

Partitioned Tray
Any quantity, no code required.

R

Tape-Reel
Tape-reel contains 500 switches.
Min. Leader Length: 15.748" (400mm)
Min. Trailer Length: 6.299" (160mm)

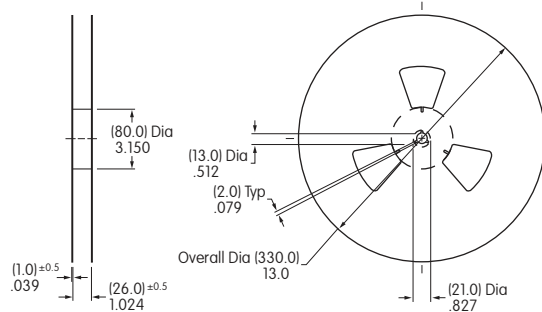

Reel Dimensions

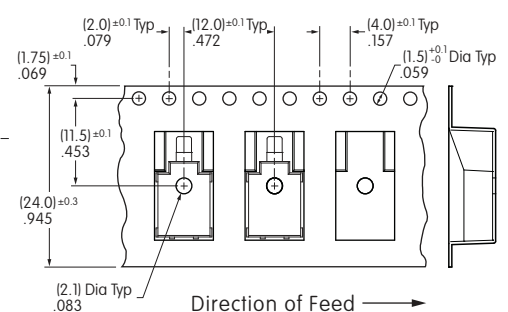

Tape Dimensions

Effective Date May 2017

NIKK
SWITCHES

http://www.nkkswitches.com • 1.877.2BUYNKK (228.9655)
7850 East Gelding Drive • Scottsdale, AZ 85260 • Telephone 480.991.0942 • Fax 480.998.1435