

AVE600-48S12B

600 Watts

Half-brick Converter

Total Power: 600 Watts
Input Voltage: 36 to 75 Vdc
of Outputs: Single

Special Features

- Delivering up to 50A output
- Industry standard half-brick foot print
- Basic isolation
- Ultra-high efficiency 95.6% typ. at 12V half load($V_{in}=48V$)
- Wide input range: 36V ~ 75V
- Excellent thermal performance
- No minimum load requirement
- High power density
- Low output noise
- RoHS 6 compliant
- Remote control function (negative logic)
- Remote output sense
- Trim function: 90% ~ 110%
- Input under voltage lockout
- Output over current protection
- Output short circuit protection
- Output over voltage protection
- Over temperature protection
- Industry standard half-brick pin-out outline
- Choice of short pins or long pins
- Pin length option

Safety

IEC/EN/UL/CSA 60950
CE Mark
UL/TUV
EN55022 Class B

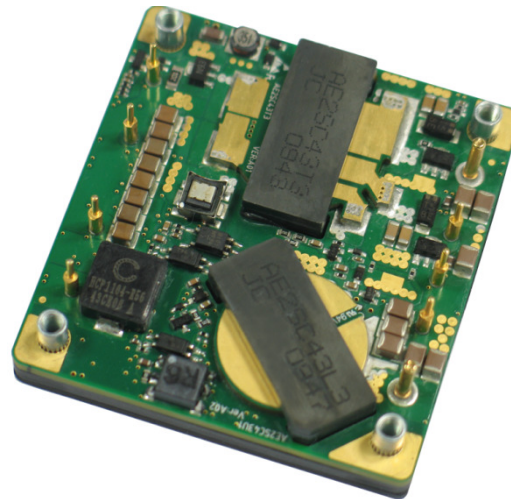

Product Descriptions

The AVE600-48S12B series is a single output DC-DC converter with standard half-brick outline and pin configuration. It delivers up to 50A output current with 12V output voltage. Ultra-high 95.6% efficiency and excellent thermal performance makes it an ideal choice for use in datacom and telecommunication applications and can work under $-40^{\circ}\text{C} \sim +85^{\circ}\text{C}$.

Applications

Telecom/ Datacom

Model Numbers

Standard	Output Voltage	Structure	Remote ON/OFF logic	RoHS Status
AVE600-48S12B-4L	12Vdc	Open-frame	Negative	R6
AVE600-48S12BP-4L	12Vdc	Open-frame	Positive	R6
AVE600-48S12B-9LZ	12Vdc	Open-frame	Negative	R6

Ordering information

AVE600	-	48	S	12	P	B	-	4	L
①		②	③	④	⑤	⑥		⑦	⑧

①	Model series	AVE: high efficiency sixteenth brick series, 600: output power 600W
②	Input voltage	48: 36V ~ 75V input range, rated input voltage 48V
③	Output number	S: single output
④	Rated output voltage	12: 12V output
⑤	Remote ON/OFF logic	Default: negative logic; P: positive logic
⑥	Baseplate	B: with baseplate; default: open frame
⑦	Pin length	4: 4.8mm ± 0.5mm; Z: 4.0mm
⑧	RoHS status	Y: RoHS, R5; L: RoHS, R6

Options

None

Electrical Specifications

Absolute Maximum Ratings

Stress in excess of those listed in the “Absolute Maximum Ratings” may cause permanent damage to the power supply. These are stress ratings only and functional operation of the unit is not implied at these or any other conditions above those given in the operational sections of this TRN. Exposure to any absolute maximum rated condition for extended periods may adversely affect the power supply’s reliability.

Table 1. Absolute Maximum Ratings:

Parameter	Model	Symbol	Min	Typ	Max	Unit
Input Voltage Operating -Continuous Non-operating -100mS	All	$V_{IN,DC}$	-	-	80	Vdc
	All		-	-	100	Vdc
Maximum Output Power	All	$P_{O,max}$	-	-	600	W
Isolation Voltage ¹ Input to outputs	All		1500	-	-	Vdc
Ambient Operating Temperature	All	T_A	-40	-	+85	°C
Storage Temperature	All	T_{STG}	-55	-	+125	°C
Voltage at remote ON/OFF pin	All		-0.3	-	15	Vdc
Humidity (non-condensing) Operating Non-operating	All		-	-	95	%
	All		-	-	95	%

Note: 1 - 1mA for 60s, slew rate of 2000V/10s

Input Specifications

Table 2. Input Specifications:

Parameter	Conditions ¹	Symbol	Min	Typ	Max	Unit
Operating Input Voltage, DC	All	$V_{IN,DC}$	36	48	75	Vdc
Turn-on Voltage Threshold	$I_O = I_{O,max}$	$V_{IN,ON}$	-	35	36	Vdc
Turn-off Voltage Threshold	$I_O = I_{O,max}$	$V_{IN,OFF}$	32	34	-	Vdc
Lockout Voltage Hysteresis	$I_O = I_{O,max}$		1	-	3	V
Maximum Input Current ($I_O = I_{O,max}$)	$V_{IN,DC} = 36V_{DC}$	$I_{IN,max}$	-	-	24	A
Recommended Input Fuse	Fast blow external fuse recommended		-	-	30	A
No-Load Input Current	All	I_{IN,no_load}	-	-	0.2	A
Standby Input Current	Remote off	$I_{IN,standby}$	-	0.08	0.1	A
Recommended External Input Capacitance	Low ESR capacitor recommended	C_{IN}	-	470	-	uF
Input Reflected Ripple Current	Through 12uH inductor		-	50	150	mA
Input Filter Component Value(C\L)	Internal values		-	17.6\0.6 5	-	μF\μH
Operating Efficiency	$T_A=25\text{ }^{\circ}\text{C}$ $I_O = I_{O,max}$ $I_O = 50\%I_{O,max}$	η	-	94.8 95.6	-	% %

Note 1 - $T_a = 25\text{ }^{\circ}\text{C}$, airflow rate = 400 LFM, $V_{in} = 48\text{Vdc}$, nominal V_{out} unless otherwise noted.

Output Specifications

Table 3. Output Specifications:

Parameter	Conditions ¹	Symbol	Min	Typ	Max	Unit	
Factory Set Voltage	$V_{IN,DC} = 48V_{DC}$ $I_O = I_{O,max}$	V_O	11.8	12	12.2	Vdc	
Total Regulation	Inclusive of line, load temperature change, warm-up drift	V_O	11.7	12	12.3	Vdc	
Output Voltage Line Regulation	All	$\%V_O$	-	0.15	0.33	%	
Output Voltage Load Regulation	All	$\%V_O$	-	0.1	0.2	%	
Output Voltage Temperature Regulation	All	$\%V_O$	-	-	0.02	$\%/^{\circ}C$	
Output Voltage Trim Range	All	V_O	10.8	-	13.2	V	
Output Ripple, pk-pk	Measure with a 1uF ceramic capacitor in parallel with a 10uF tantalum capacitor, 0 to 20MHz bandwidth	V_O	-	100	200	mV _{PK-PK}	
Output Current	All	I_O	0	-	50	A	
Output DC current-limit inception ²		I_O	52.5	-	65	A	
V_O Load Capacitance ³	All	C_O	680	2200	10000	uF	
V_O Dynamic Response	Peak Deviation Settling Time	50%~75%~50% 25% load change slew rate = 0.1A/us	$\pm V_O$	-	250	-	mV
		50%~75%~50% 25% load change slew rate = 1A/us	T_s	-	110	-	uSec
Turn-on transient	Rise time	$I_O = I_{max}$	T_{rise}	-	40	100	mS
	Turn-on delay time	$I_O = I_{max}$	$T_{turn-on}$	-	120	150	mS
	Output voltage overshoot	$I_O = 0$	$\%V_O$	-	-	1	%
Switching frequency	All	f_{SW}	130	140	150	KHz	
Remote ON/OFF control (positive logic)	Off-state voltage	All	-0.7	-	1.2	V	
	On-state voltage	All	3.5	-	12	V	

Note 1 - $T_a = 25^{\circ}C$, airflow rate = 400 LFM, $V_{in} = 48V_{dc}$, nominal V_{out} unless otherwise noted.

Note 2 - Hiccup: auto-restart when over-current condition is removed.

Note 3 - High frequency and low ESR is recommended.

Output Specifications

Table 3. Output Specifications, con't:

Parameter		Conditions	Symbol	Min	Typ	Max	Unit
Remote ON/OFF control (Negative logic)	Off-state voltage	All		3.5	-	12	V
	On-state voltage	All		-0.7	-	1.2	V
Output over-voltage protection ⁴		All		14	-	17	V
Output over-temperature protection ⁵		All	T	110	125	135	°C
Over-temperature hysteresis		All	T	-	10	-	°C
+ Sense		All	%Vo	-	-	10	%
- Sense		All	%Vo	-	-	10	%
MTBF		Telcordia SR-332-2006; 80% load, 300LFM, 40 °C T _A		-	1.5	-	10 ⁶ h

Note 4 - Hiccup: auto-restart when over-voltage condition is removed.

Note 5 - Auto recovery.

AVE600-48S12B Performance Curves

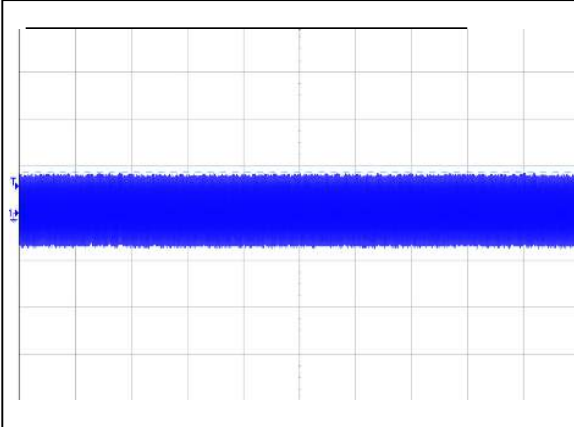

Figure 1: AVE600-48S12B Input Reflected Ripple Current Waveform
Ch 1: Iin (100mS/div, 50mA/div)

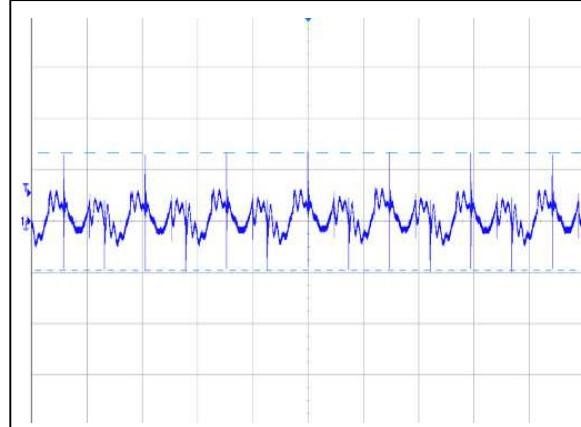

Figure 2: AVE600-48S12B Ripple and Noise Measurement
Ch 1: Vo (2us/div, 20mV/div)

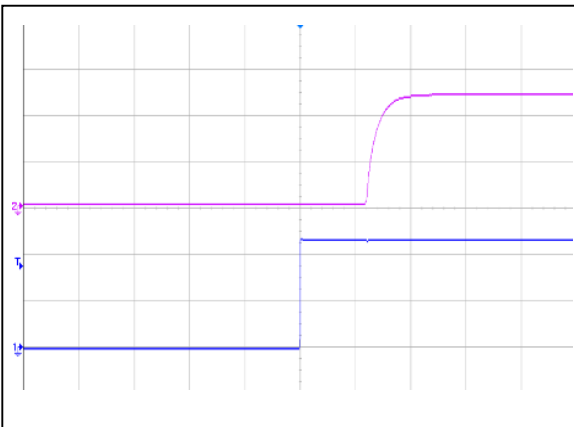

Figure 3: AVE600-48S12B Output Voltage Startup Characteristic (100mS/div)
Ch 2: Vo (5V/div) Ch 1: Vin (20V/div)

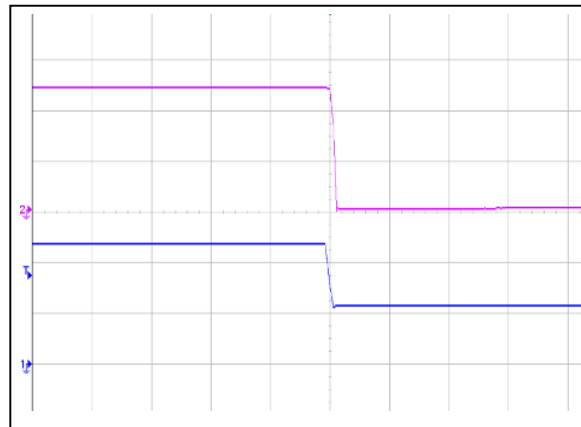

Figure 4: AVE600-48S12B Turn Off Characteristic (5mS/div)
Ch 2: Vo (5V/div) Ch 1: Vin (20V/div)

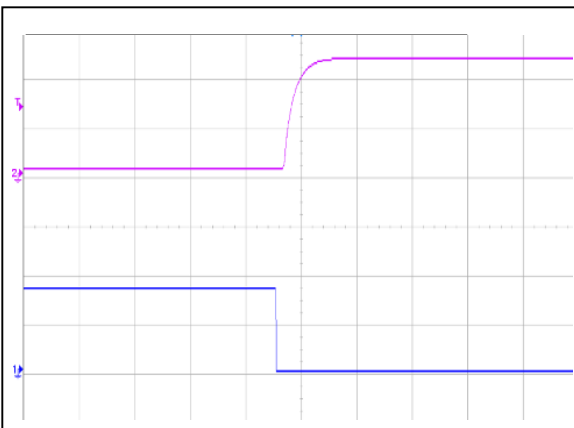

Figure 5: AVE600-48S12B Remote ON Waveform (100mS/div)
Ch 2: Vo (5V/div) Ch 1: Remote ON (2V/div)

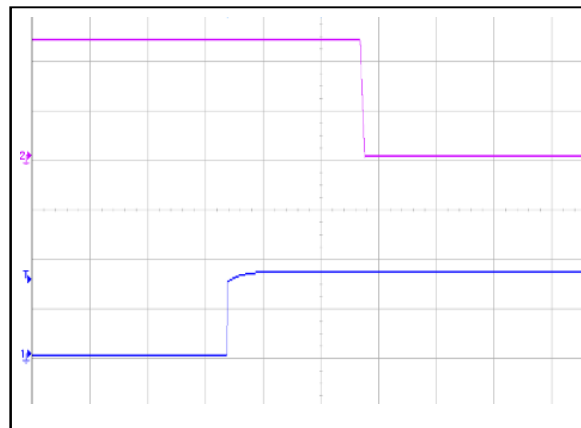

Figure 6: AVE600-48S12B Remote OFF Waveform (5mS/div)
Ch 2: Vo (5V/div) CH1: Remote OFF (2V/div)

AVE600-48S12B Performance Curves

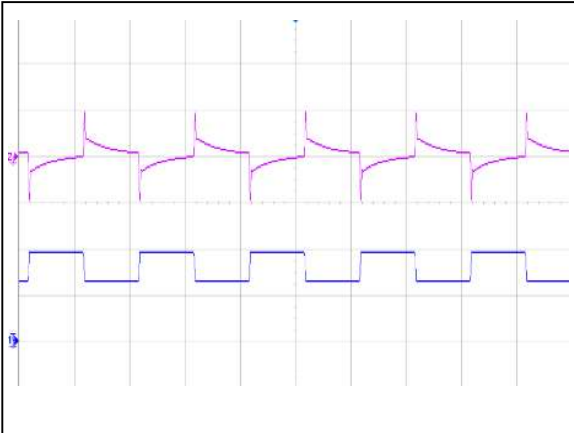

Figure 7: AVE600-48S12B Transient Response (5mS/div)
 0.1A/uS slew rate
 Ch 3: Vo (200mV/div) Ch 1: Io (20A/div)

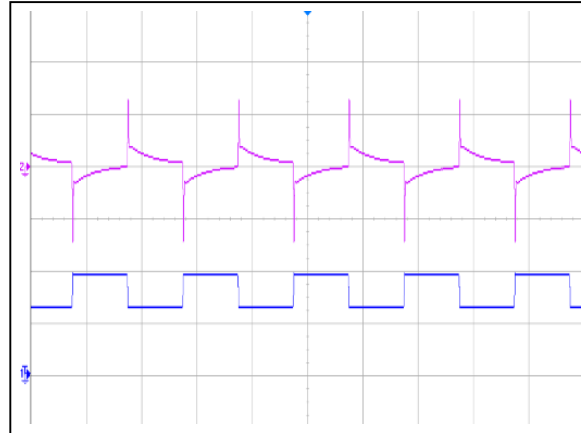

Figure 8: AVE600-48S12B Transient Response (5mS/div)
 1A/uS slew rate
 Ch 3: Vo (200mV/div) Ch 1: Io (20A/div)

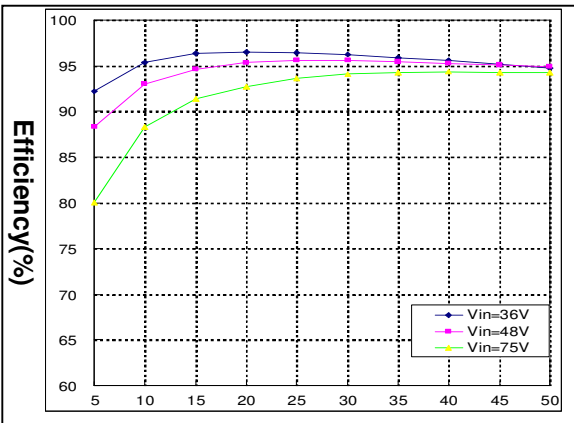

Figure 9: AVE600-48S12B Efficiency Curves @ 25 degC, Vo=12V
 Loading: Io = 10% increment to 50A

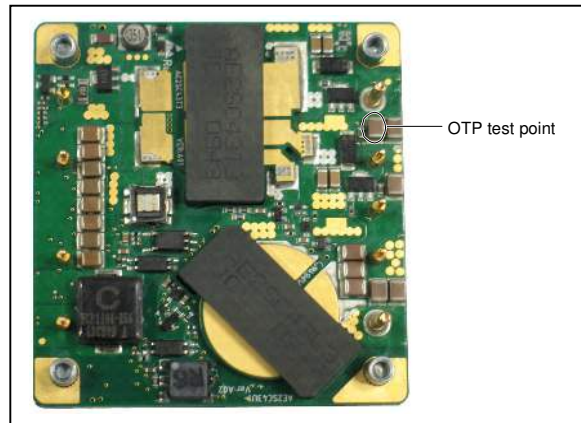
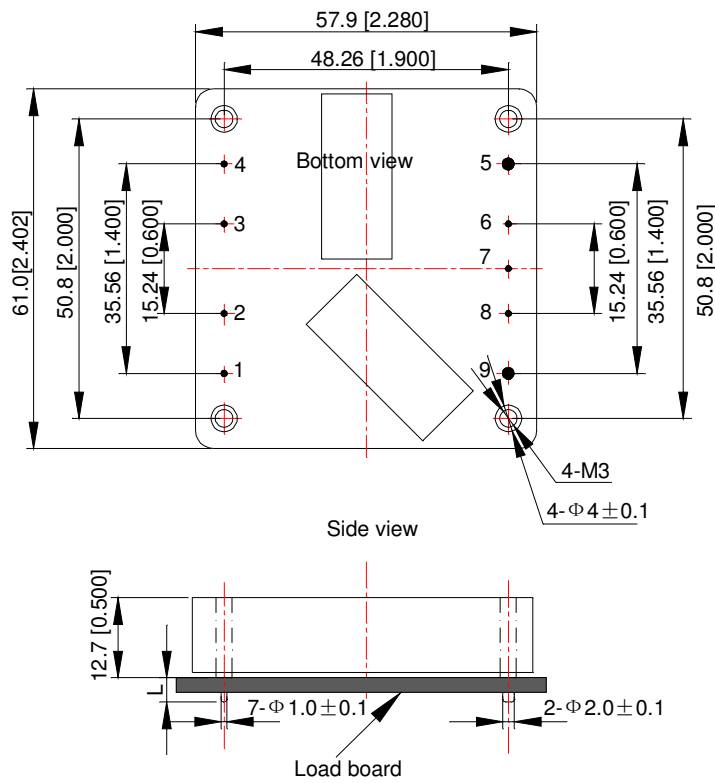

Figure 10: AVE600-48S12B Over Temperature Protection Test Point

Mechanical Specifications

Mechanical Outlines – Base Plate Module



Unit: mm[inch] Bottom view: pin on upside
 Tolerance: X.Xmm \pm 0.5mm[X.X in. \pm 0.02in.]
 X.XXmm \pm 0.25mm[X.XX in. \pm 0.01in.]
 Base plate

Figure 11 Open Frame Module Mechanical diagram

Pin Length Option

Device code suffix	L
-4	4.8mm ± 0.2 mm
-6	3.8mm ± 0.2 mm
-8	2.8mm ± 0.2 mm
None	5.8mm ± 0.2 mm

Pin Designations

Pin No	Name	Function
1	Vin+	Positive input terminal
2	Remote On/Off	Remote control terminal
3	Case	Pin connected to baseplate
4	Vin-	Negative input terminal
5	Vo-	Negative output terminal
6	Sense-	Negative remote sense
7	Trim	Output voltage trim
8	Sense+	Positive remote sense
9	Vo+	Positive output terminal

Environmental Specifications

EMC Immunity

AVE600-48S12B power supply is designed to meet the following EMC immunity specifications:

Table 4. Environmental Specifications:

Document	Description	Criteria
EN55022, Class A Limits	Conducted and Radiated EMI Limits	/
IEC/EN 61000-4-2, Level 3	Electromagnetic Compatibility (EMC) - Testing and measurement techniques - Electrostatic discharge immunity test. Enclosure Port	B
IEC/EN 61000-4-6, Level 2	Electromagnetic Compatibility (EMC) - Testing and measurement techniques, Continuous Conducted Interference. DC input port	A
IEC/EN 61000-4-4, Level3	Electromagnetic Compatibility (EMC) - Testing and measurement techniques, Electrical Fast Transient. DC input port.	B
IEC/EN 61000-4-5	Electromagnetic Compatibility (EMC) - Testing and measurement techniques, Immunity to surges - 600V common mode and 600V differential mode for DC ports	B
EN61000-4-29	Electromagnetic Compatibility (EMC) - Testing and measurement techniques, Voltage Dips and short interruptions and voltage variations. DC input port	B

Criterion A: Normal performance during and after test.

Criterion B: For EFT and surges, low-voltage protection or reset is not allowed. Temporary output voltage fluctuation ceases after disturbances ceases, and from which the EUT recovers its normal performance automatically. For Dips and ESD, output voltage fluctuation or reset is allowed during the test, but recovers to its normal performance automatically after the disturbance ceases.

Recommend EMC Filter Configuration

See Figure 15

Safety Certifications

The AVE600-48S12B power supply is intended for inclusion in other equipment and the installer must ensure that it is in compliance with all the requirements of the end application. This product is only for inclusion by professional installers within other equipment and must not be operated as a stand alone product.

Table 5. Safety Certifications for AVD50-48S3V3 power supply system

Document	File #	Description
UL/CSA 60950		US and Canada Requirements
EN60950		European Requirements
IEC60950		International Requirements
CE		CE Marking

Operating Temperature

The AVE600-48S12B power supply will start and operate within stated specifications at an ambient temperature from -40 °C to 85 °C under all load conditions. The storage temperature is -55 °C to 125 °C.

Thermal Considerations – Open-frame module

The converter is designed to operate in different thermal environments and sufficient cooling must be provided. Proper cooling of the DC/DC converter can be verified by measuring the temperature at the test point as shown in the Figure 12. The temperature at this point should not exceed the max values in the table 6.

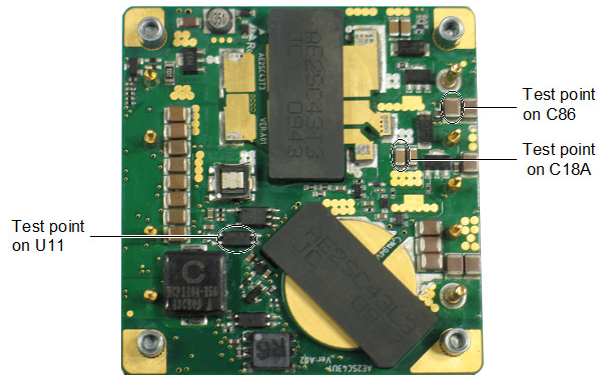

Figure 12 Temperature test point

Table 6. Temperature limit of the test point

Test Point	Temperature Limit
Test point on C86	116 °C
Test point on U11	113 °C
Test point on C18A	118 °C

For a typical application, figure 13 shows the derating of output current vs. ambient air temperature at different air velocity.

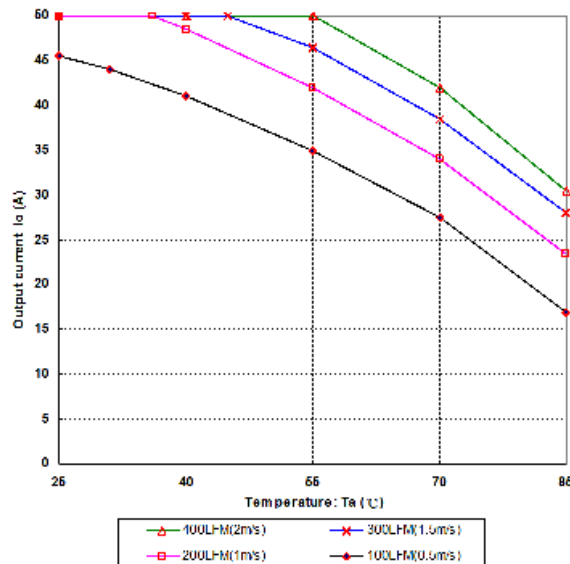

Figure 13 Output power derating, 48Vin, air flowing across the converter from pin 4 to pin 1

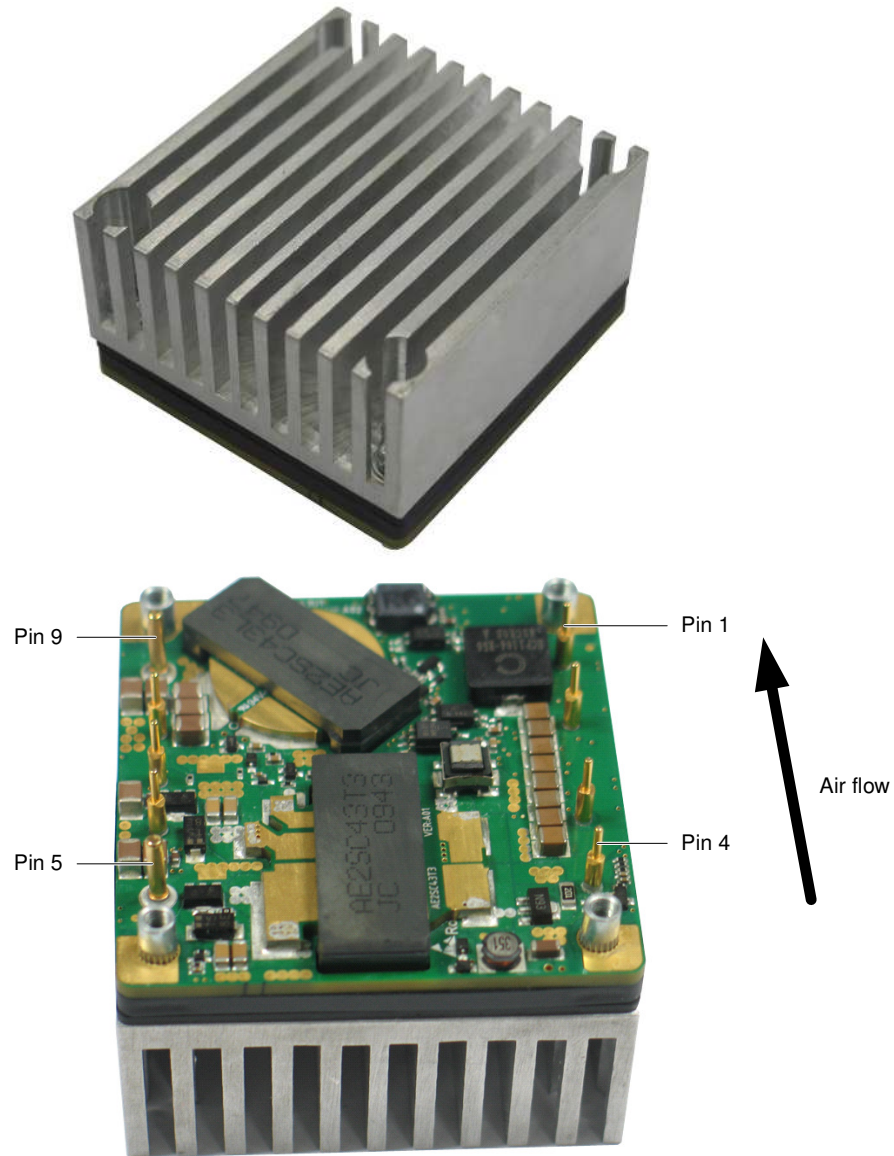

Figure 14 Typical test condition, heat sink size
(L×W×H): 61mm×58mm×25.4mm

Qualification Testing

Parameter	Unit (pcs)	Test condition
Halt test	4-5	$T_{a,min} - 10\text{ }^{\circ}\text{C}$ to $T_{a,max} + 10\text{ }^{\circ}\text{C}$, $5\text{ }^{\circ}\text{C}$ step, $V_{in} = \text{min to max}$, $0 \sim 105\%$ load
Vibration	3	Frequency range: $5\text{Hz} \sim 20\text{Hz}$, $20\text{Hz} \sim 200\text{Hz}$, A.S.D: $1.0\text{m}^2/\text{s}^3$, -3db/oct , axes of vibration: X/Y/Z. Time: 30min/axes
Mechanical Shock	3	30g, 6ms, 3axes, 6directions, 3time/direction
Thermal Shock	3	$-40\text{ }^{\circ}\text{C}$ to $100\text{ }^{\circ}\text{C}$, unit temperature 20 cycles
Thermal Cycling	3	$-40\text{ }^{\circ}\text{C}$ to $55\text{ }^{\circ}\text{C}$, temperature change rate: $1\text{ }^{\circ}\text{C}/\text{min}$, cycles: 2cycles
Humidity	3	$40\text{ }^{\circ}\text{C}$, 95%RH, 48h
Solder Ability	15	IPC J-STD-002C-2007

Application Notes

Typical Application

Below is the typical application of the AVE600-48S12B power supply.

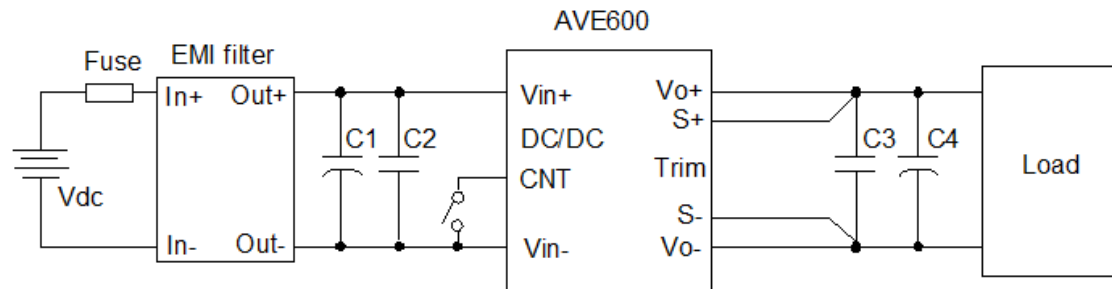

Figure 15 Typical application

C1: 470uF/100V electrolytic capacitor, P/N: UPM2A471MHD (Nichicon) or equivalent caps

C2, C3: 1uF/100V X7R ceramic capacitor, P/N: C3225X7R2A105KT0L0U (TDK) or equivalent caps

C4: 2200uF electrolytic capacitor, P/N: UPM1E222MHD (Nichicon) or equivalent caps

Note: The converter can't be used in parallel mode directly.

Fuse: External fast blow fuse with a rating of 30A. The recommended fuse model is 314030P from LITTLEFUSE.

Remote ON/OFF

Negative or positive remote ON/OFF logic is available in AVE600-48S12B. The logic is CMOS and TTL compatible.

For the negative logic model a system logic high signal will turn the converter off. For negative logic models where no control signal will be used the ON/OFF pin should be connected directly to $-V_{in}$ to ensure proper operation. For positive logic models where no control signal will be used the ON/OFF pin should be left unconnected

The voltage between pin Remote ON/OFF and pin V_{in-} must not exceed the range listed in table 3 to ensure proper operation. The external Remote ON/OFF circuit is highly recommended as shown in figure 16.

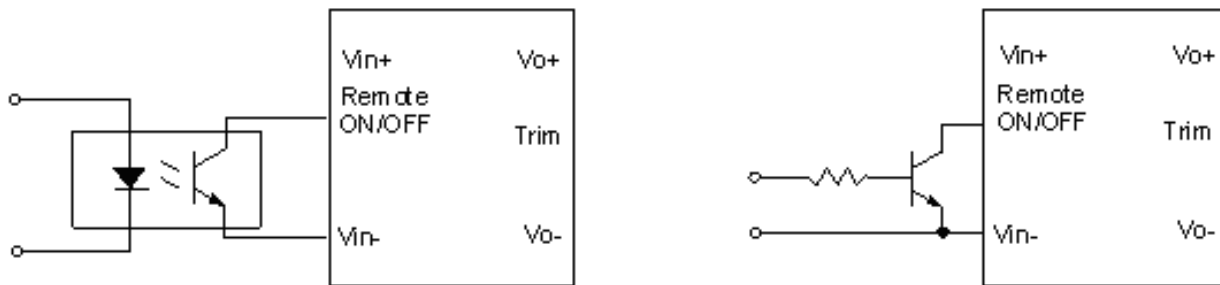

Isolated remote ON/OFF circuit

Non-isolated remote ON/OFF circuit

Figure 16 External Remote ON/OFF circuit

Trim Characteristics

Connecting an external resistor between Trim pin and Vo- pin will decrease the output voltage. While connecting it between Trim and Vo+ will increase the output voltage. The following equations determine the external resistance to obtain the trimmed output voltage.

$$R_{adj-down} = \frac{100\%}{\Delta\%} - 2(K\Omega)$$

$$R_{adj-up} = \frac{V_{nom} \times (100\% + \Delta\%)}{1.225 \times \Delta\%} - \frac{100\%}{\Delta} - 2(K\Omega)$$

Δ : Output error rate against nominal output voltage.

$$\Delta = \frac{100 \times (V_{nom} - V_0)}{V_{nom}}$$

V_{nom} : Nominal output voltage.

For example, to get 13.2V output, the trimming resistor is

$$R_{adj-up} = \frac{13.2}{1.225 \times (13.2 - 12) / 12} - \frac{100\%}{(13.2 - 12) / 12} - 2 = 95.75(K\Omega)$$

The output voltage can also be trimmed by potential applied at the Trim Pin.

$$V_o = (V_{trim} + 1.225) \times 4.898$$

When trimming up, the output current should be decreased accordingly so as not to exceed the maximum output power.

Internal side

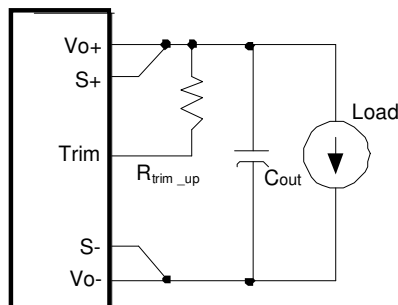

Figure 17 Trim up

Internal side

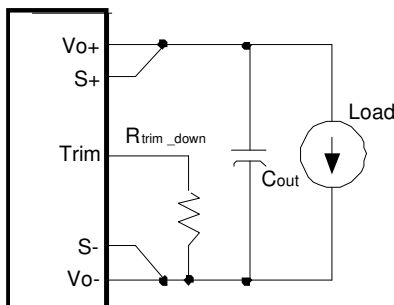

Figure 18 Trim down

Input Ripple & Output Ripple & Noise Test Configuration

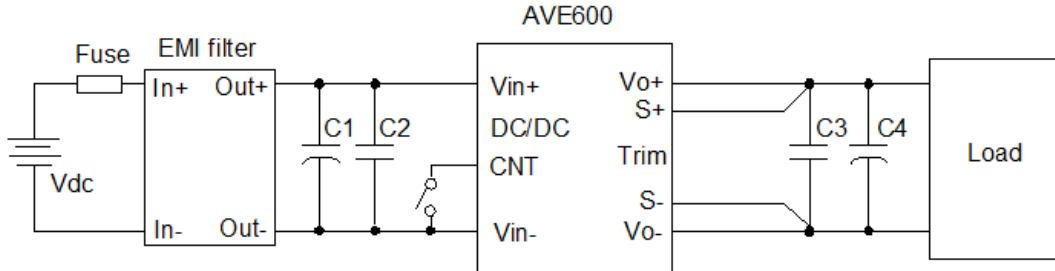

Figure 19 Input ripple & output ripple & noise test configuration

V_{dc}: DC power supply

L1: 12uH

C_{in}: 220uF/100V typical

C1 ~ C4: See Figure 15

Note - Using a coaxial cable with series 50ohm resistor and 0.68uF ceramic capacitor or a ground ring of probe to test output ripple & noise is recommended.

Soldering

The product is intended for standard manual or wave soldering.

When wave soldering is used, the temperature on pins is specified to maximum 260 °C for maximum 7s.

When manual soldering is used, the iron temperature should be maintained at 300 °C ~ 380 °C and applied to the converter pins for less than 10s. Longer exposure can cause internal damage to the converter.

Cleaning of solder joint can be performed with cleaning solvent IPA or similitive.

Hazardous Substances Announcement (RoHS of China)

Parts	Hazardous Substances					
	Pb	Hg	Cd	Cr ⁶⁺	PBB	PBDE
AVE600-48S12B-4L	x	x	x	x	x	X
AVE600-48S12BP-4L	x	x	x	x	x	X
AVE600-48S12B-9LZ	x	x	x	x	x	X

x: Means the content of the hazardous substances in all the average quality materials of the part is within the limits specified in SJ/T-11363-2006

√: Means the content of the hazardous substances in at least one of the average quality materials of the part is outside the limits specified in SJ/T11363-2006

Artesyn Embedded Technologies has been committed to the design and manufacturing of environment-friendly products. It will reduce and eventually eliminate the hazardous substances in the products through unremitting efforts in research. However, limited by the current technical level, the following parts still contain hazardous substances due to the lack of reliable substitute or mature solution:

1. Solders (including high-temperature solder in parts) contain plumbum.
2. Glass of electric parts contains plumbum.
3. Copper alloy of pins contains plumbum

WORLDWIDE OFFICES

Americas

2900 S.Diablo Way
 Tempe, AZ 85282
 USA
 +1 888 412 7832

Europe (UK)

Waterfront Business Park
 Merry Hill, Dudley
 West Midlands, DY5 1LX
 United Kingdom
 +44 (0) 1384 842 211

Asia (HK)

14/F, Lu Plaza
 2 Wing Yip Street
 Kwun Tong, Kowloon
 Hong Kong
 +852 2176 3333



www.artesyn.com

While every precaution has been taken to ensure accuracy and completeness in this literature, Artesyn Embedded Technologies assumes no responsibility, and disclaims all liability for damages resulting from use of this information or for any errors or omissions. Artesyn Embedded Technologies, Artesyn and the Artesyn Embedded Technologies logo are trademarks and service marks of Artesyn Technologies, Inc. All other names and logos referred to are trade names, trademarks, or registered trademarks of their respective owners.
 © 2014 All rights reserved.

For more information: www.artesyn.com/power
 For support: productsupport.ep@artesyn.com