

Mechanical Dimensions: Inches [mm]

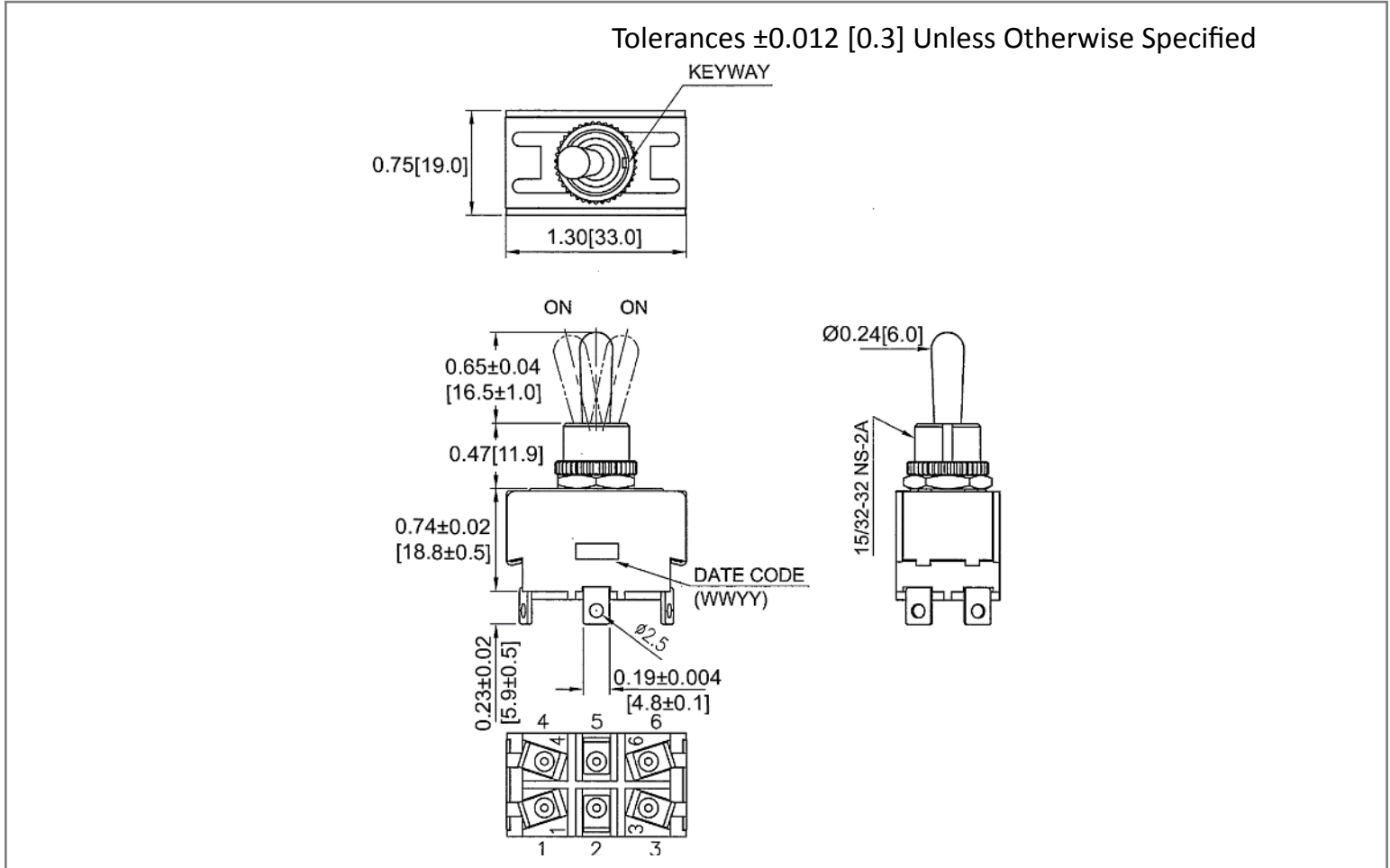

Mounting Hole

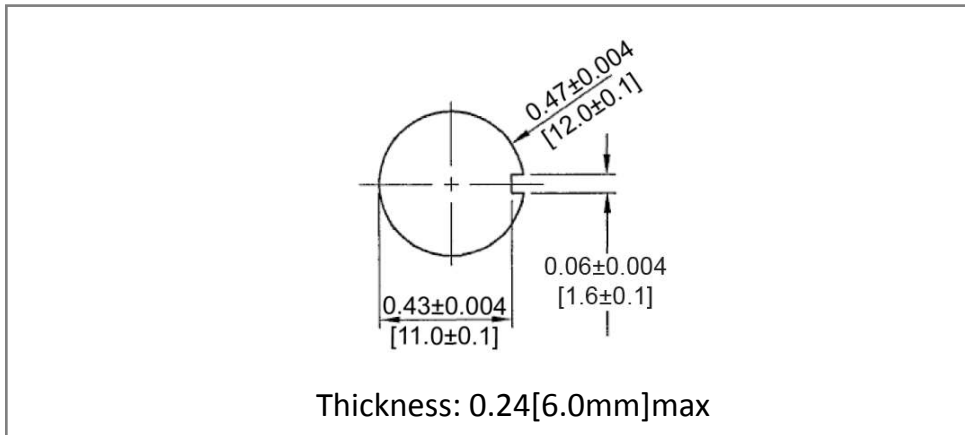

Circuit Diagram

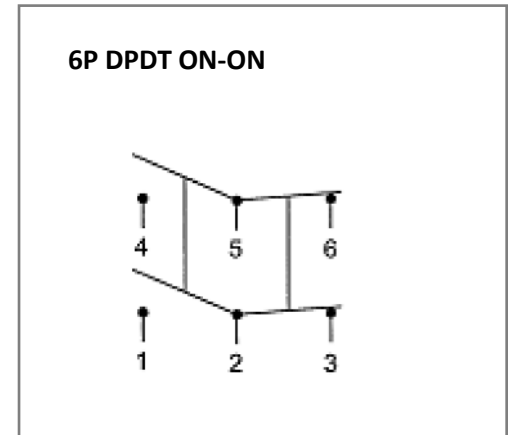

Electrical Specifications

Rating	20A 125V AC, 10A 277V AC, 1 1/2HP 125-250V AC 10(4)A 125/250V AC
Contact Resistance	50m ohm Max
Insulation Resistance	DC 500V 100M ohm Min
Dielectric Strength	AC 1500V 1 minute
Operation Temperature	1200gf±300gf

Material Specifications

1 Hex Nut Assy
1 Knurl Nut Assy

Rev	Date of issue	Revision Notes	Designed	Approved
B	11-30-2021	Initial Drawing	RC	OF