

PART NUMBER

BL23E48-02-HP05

MOTOR SPECIFICATIONS

Part Number	BL23E48-02
Dimension "A"	4.78 in 121.5 mm
Rated Voltage	48 VDC
Rated Torque	60.89 oz-in 0.43 N-m
Rated Speed	4000 RPM
Rated Power	180 Watts
Rated Current	4.5 Amps
Peak Torque	121.78 oz-in 0.85 N-m
Peak Current	9 Amps
Torque Constant (kt)	13.59 oz-in/Amp
Back EMF Constant (Ke)	9.09 Vp/KRPM
Motor Constant (Km)	20.49 oz-in/√W 0.145 N-m/√W
Resistance	0.44 Ohms
Inductance	0.54 mH
Rotor Inertia	2.49 oz-in ²
Weight	3.75 lb 1.7 kg
Electrical Time Constant	1.2 ms
Mechanical Time Constant	2.4 ms

GEARBOX SPECIFICATIONS

Part Number	HP05
Ratio	5:1
Nominal Output Torque (Nm)	60
Emergency Stop Torque (Nm)	3 times nominal output torque
Nominal Input Speed (RPM)	5000
Max Input Speed (RPM)	10000
Max Radial Load (N)	1377
Max Axial Load (N)	765
Efficiency η (%)	90
Backlash (arcmin)	<5
Protection Class	IP65 (gearbox), IP40 (motor)
Service Life (hr)	20000
Weight (kg)	1.4
Operating Temperature (°C)	-20 to 90
Lubrication	Grease
Noise (n=3000 rpm) dB(A)	56
Mass Movement of Inertia (kg-cm ²)	0.13



PERFORMANCE CURVE

BL23E48-02 GEARMOTOR TORQUE CURVES

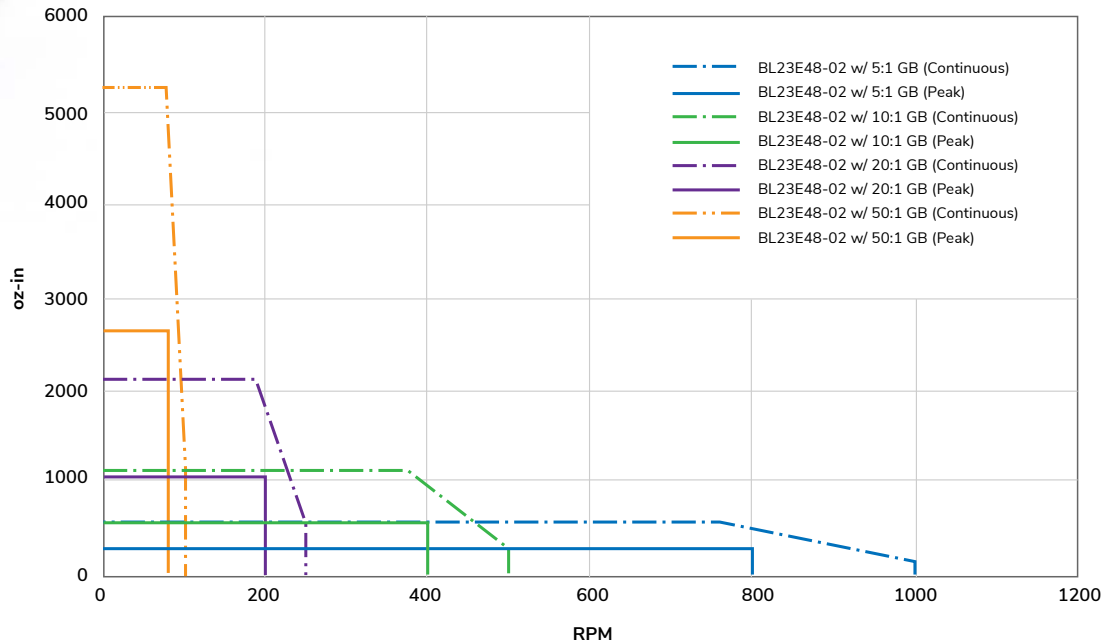

DIMENSIONS

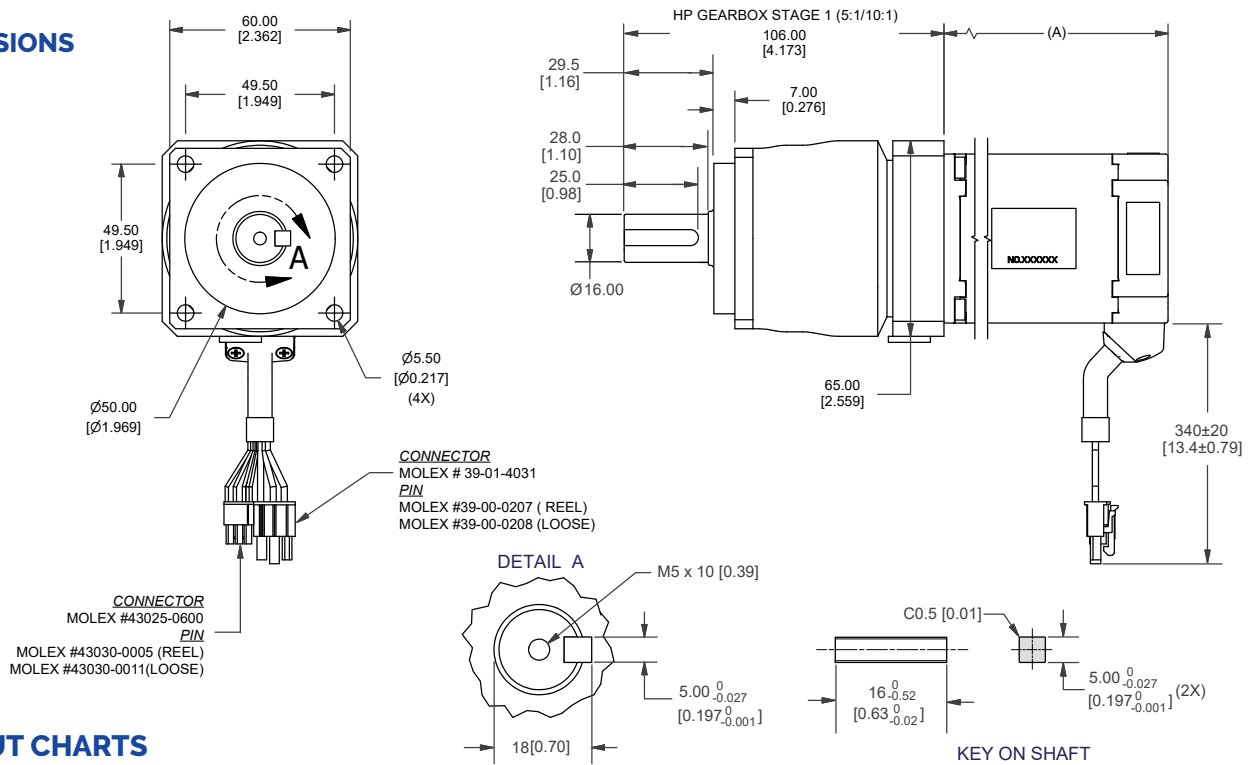

PIN OUT CHARTS

PIN #	COLOR	PHASE
1	RED	VCC (+5V)
2	YELLOW	HV
3	BLUE	HW
4	BLACK	GND
5	ORANGE	HU

PIN #	COLOR	PHASE
1	BLUE	W
2	ORANGE	U
5	YELLOW	V

RECOMMENDED PRODUCTS



BLDC DRIVER
BLDC50-BL23E22-02



BLDC EXTENSION CABLE
4201-100/300

OPERATION & USAGE TIPS



Do not disassemble motors; a significant reduction in motor performance will occur.



Do not machine shafts; this will have a negative effect on shaft run out and perpendicularity.

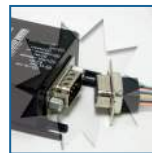

Do not disconnect motor from drive while in operation.

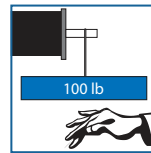

Do not use holding torque/detent torque of motor as a fail safe brake.



Do not hold motor by lead wires.



Do not exceed the rated current; this will damage the motor.

FAILURE TO COMPLY WITH THESE RECOMMENDATIONS WILL VOID ALL WARRANTY TERMS

Motion Control, Solved.

MOTOR ENGINEERING & MANUFACTURING



Optimized
For Your
Application



Quick
Prototype
Turnaround



Small Batch
to OEM Volume
Production



US Based
Support &
Manufacturing