

Standard Product Reference Sheet

VJDV1104P-4D13A-TR

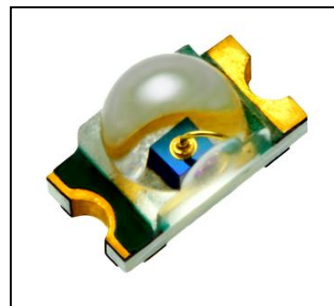

Features

Package	1608(t=1.15 mm) Type, lens color: water clear Outer Dimension 1.64 x 0.84 x 1.15mm (L x W x H)
Product features	<ul style="list-style-type: none"> • Five times brighter than current VFHV1104P • Compliant with JEDEC MSL-3 (IPC/JEDEC J-STD-020D) • Soldering pad for current 1608 size (1111C) available • Narrow spatial distribution suitable for light distribution on limited irradiation area • Lead-free soldering compatible • RoHS2 compliant

Recommended Applications

- Automotive interior, Communication Machine, Electric Household Appliances, OA/FA, Other General Applications

Outline Dimensions

VJDV1104P-4D13A-TR

Unit :mm
Weight :1.7mg
Tolerance :±0.1

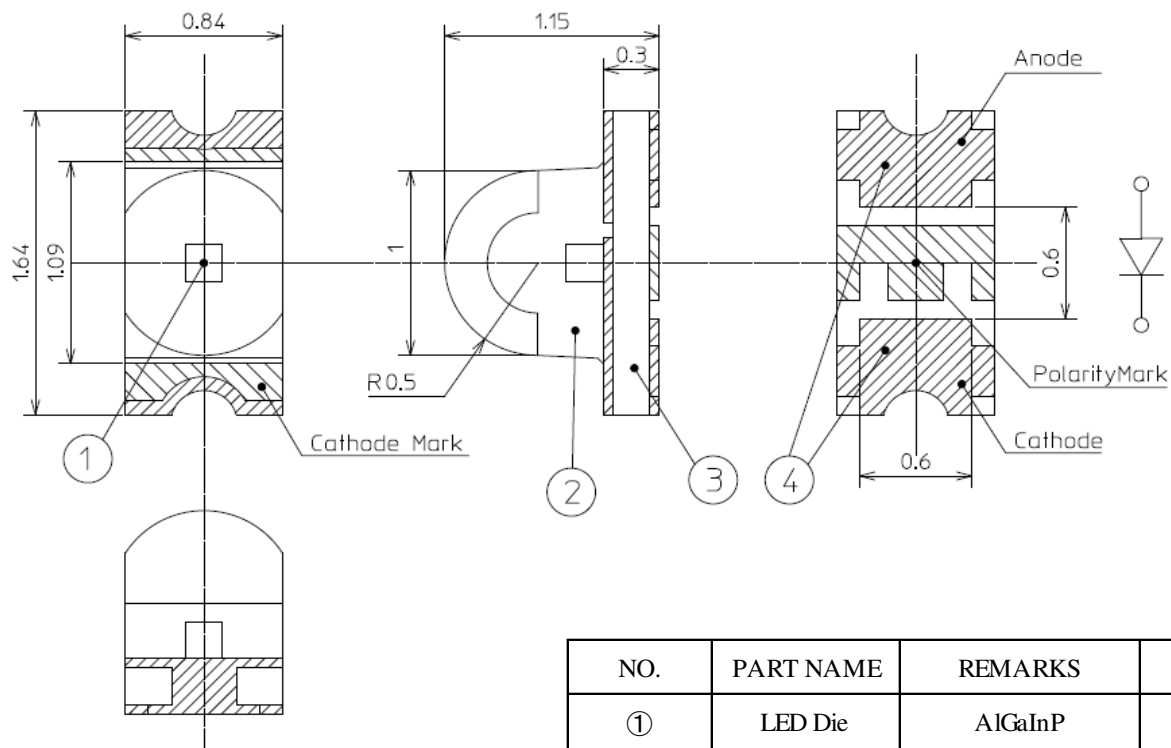

NO.	PART NAME	REMARKS	QTY.
①	LED Die	AlGaInP	1
②	Mold Resin	Epoxy Resin	1
③	Substrate	Glass Fabrics	1
④	Electrode	Au/Ni/Cu	2

Note: The cutting burr size of the Print Circuit Board and Electrode isn't contained in the size of the height of the product.

Recommended Pad

Unit : mm

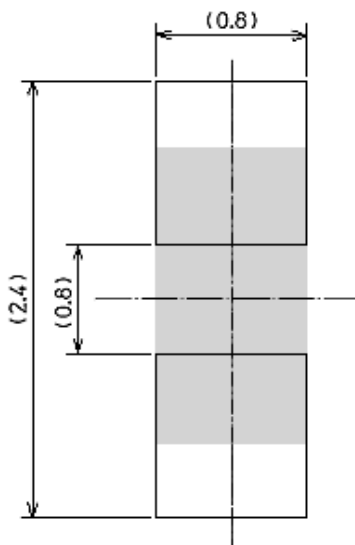

Specifications

VJDV1104P-4D13A-TR

【 Product Overview 】

Die Material	AlGaInP
Emitting Colpr	Red
Resin Color(Emitting Area)	Water Clear

【 Absolute Maximum Ratings 】

(Ta=25°C)

ITEM	SYMBOL	MAXIMUM RATINGS	UNITS
Power Dissipation	P_d	78	mW
Forward Current	I_F	30	mA
Repetitive Peak Forward Current "1ms,1/20duty"	I_{FRM}	100	mA
I_F Derate Linearly from "75°C"	ΔI_F	1.00	mA/°C
I_{FRM} Derate Linearly from "75°C"	ΔI_{FRM}	3.33	mA/°C
Reverse Voltage	V_R	5	V
Operating Temperature	T_{opr}	-40 ~ +100	°C
Storage Temperature	T_{stg}	-40 ~ +105	°C
Electrostatic Discharge Threshold "HBM"	ESD	1,000	V
Soldering Temperature "Reflow Soldering"	T_{sld}	260°C MAX	
Junction Temperature	T_j	120°C MAX	

Note1

Note2

Note 1 ESD testing method : EIAJ4701/300(304) Human Body Model(HBM) 1.5kΩ,100pF

Note 2 Please refer to page A-1, Soldering Conditions.

【 Thermal Characteristics 】

(Ta=25°C)

ITEM	SYMBOL	MIN.	TYP.	MAX.	UNITS
Thermal Resistance 【Junction - Ambient】	$R_{th(j-a)}$	-	550	-	°C/W
Thermal Resistance 【Junction - Solder point】	$R_{th(j-s)}$	-	350	-	°C/W

Note3

Note3.

 $R_{th(j-a)}$ Measuring condition

•PCB : FR-4 (t=1.6mm)

•Pattern Size : 16mm²

Specifications

VJDV1104P-4D13A-TR

【 Electro and Optical Characteristics 】

(Ta=25°C)

ITEM	SYMBOL	CONDITIONS	MIN.	TYP.	MAX.	UNITS
Forward Voltage	V_F	$I_F = 20\text{mA}$	1.9	2.1	2.5	V
Reverse Current	I_R	$V_R = 5\text{V}$	-	-	10	μA
Luminous Intensity	I_V	$I_F = 20\text{mA}$	1,000	1,500	2,200	mcd
Luminous Flux	Φ_V	$I_F = 20\text{mA}$	-	2,600	-	mlm
Peak Wavelength	λ_p	$I_F = 20\text{mA}$	-	624	-	nm
Dominant Wavelength	λ_d	$I_F = 20\text{mA}$	610	615	619	nm
Spectral Line Half Width	$\Delta\lambda$	$I_F = 20\text{mA}$	-	15	-	nm
Half Intensity Angle	$2\theta_{1/2}$	$I_F = 20\text{mA}$	-	80	-	deg.

Note:

Above Luminous Intensity (I_V) values and Dominant wavelength (λ_d) value are the setup value of the selection machine. 【Tolerance : $I_V \dots \pm 10\%$ 、 $\lambda_d \dots \pm 1\text{nm}$ 】

【 Sorting For Luminous Intensity and Dominant Wavelength 】

LEDs shall be sorted out into the following ranks of Luminous Intensity and Dominant Wavelength.

Luminous Intensity (I_V) Rank

Rank	I_V (mcd)		Conditions
	MIN.	MAX.	
D1	1,000	1,200	$I_F = 20\text{mA}$ $T_a = 25^\circ\text{C}$
D2	1,200	1,500	
D3	1,500	1,800	
D4	1,800	2,200	

Dominant Wavelength (λ_d) Rank

Rank	λ_d (nm)		Conditions
	MIN.	MAX.	
A	610	613	$I_F = 20\text{mA}$ $T_a = 25^\circ\text{C}$
B	613	616	
C	616	619	

Note Above Luminous Intensity (I_V) values and Dominant Wavelength (λ_d) values are the setup value of the selection machine.

【Tolerance : $I_V \dots \pm 10\%$ 、 $\lambda_d \dots \pm 1\text{nm}$ 】

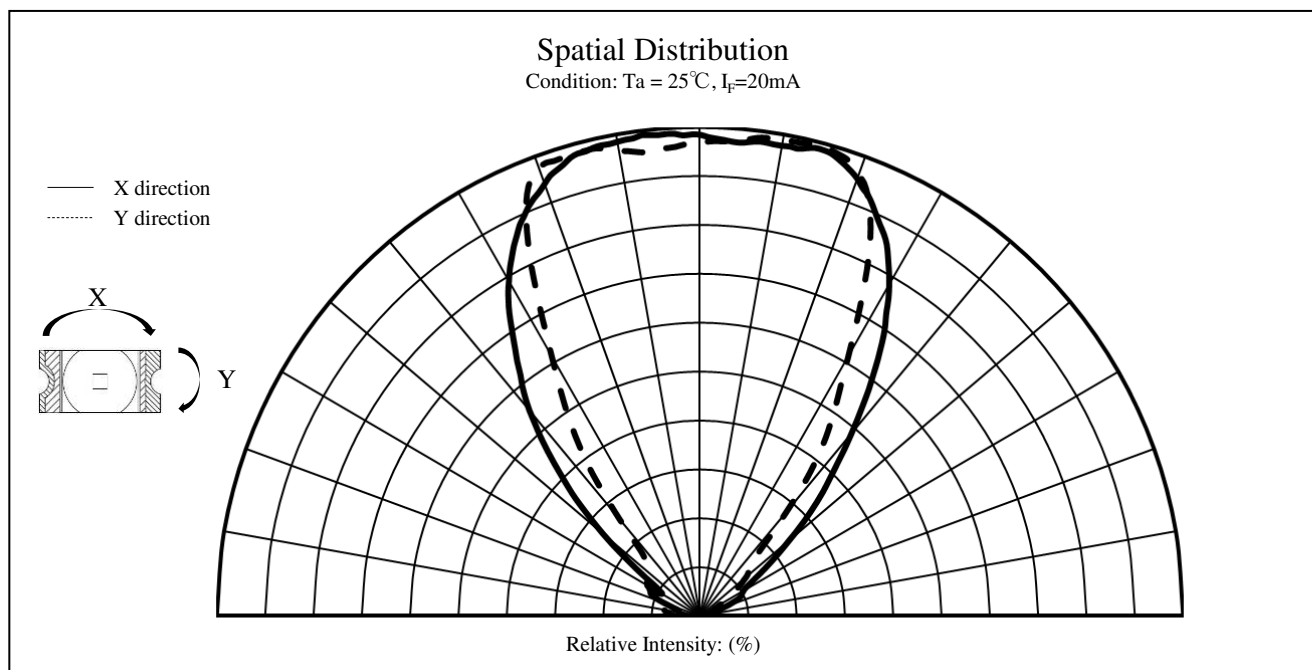
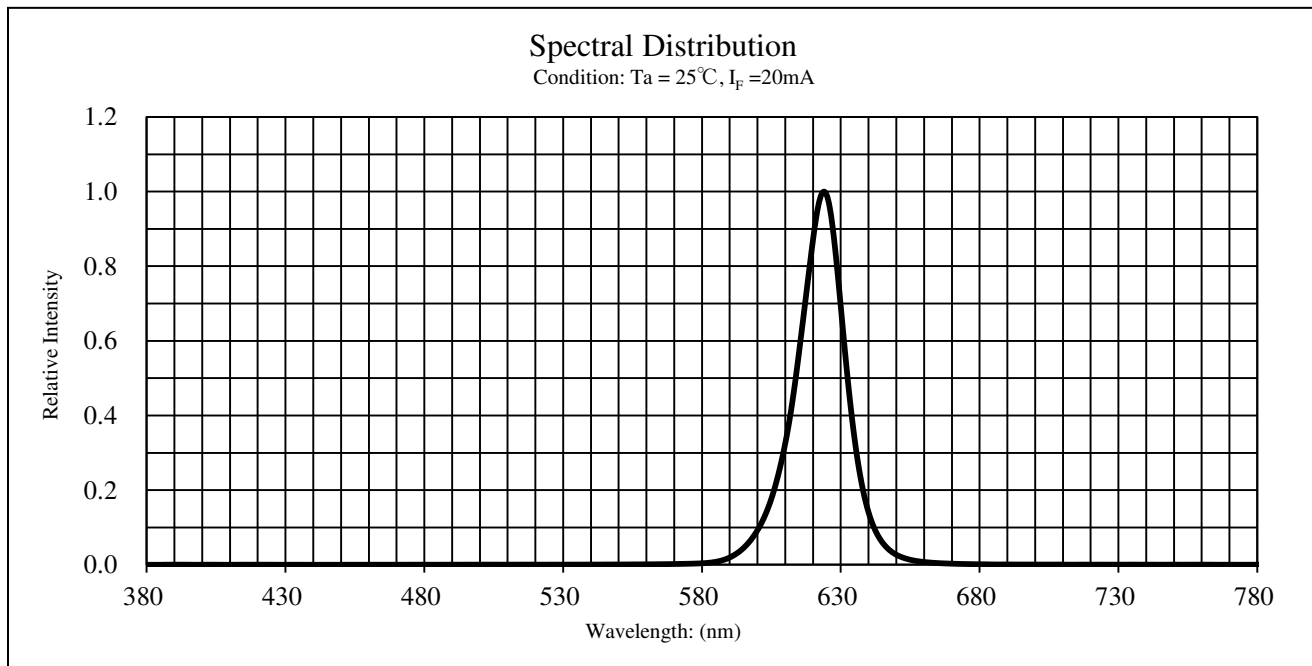

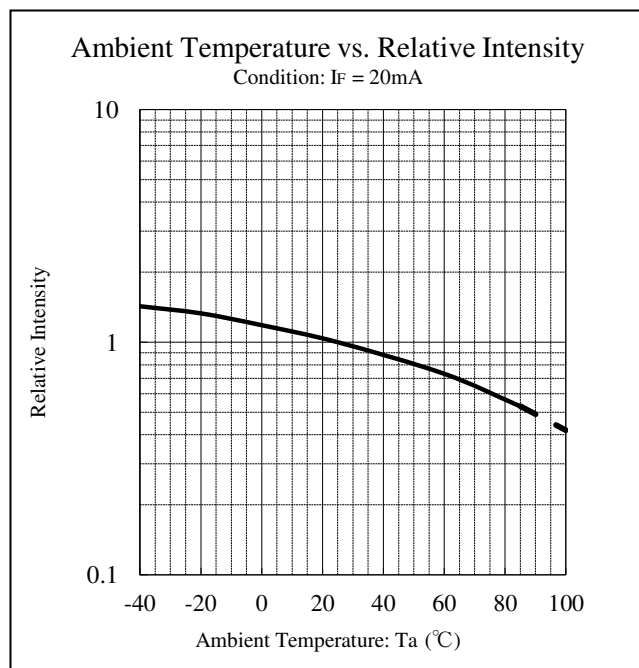
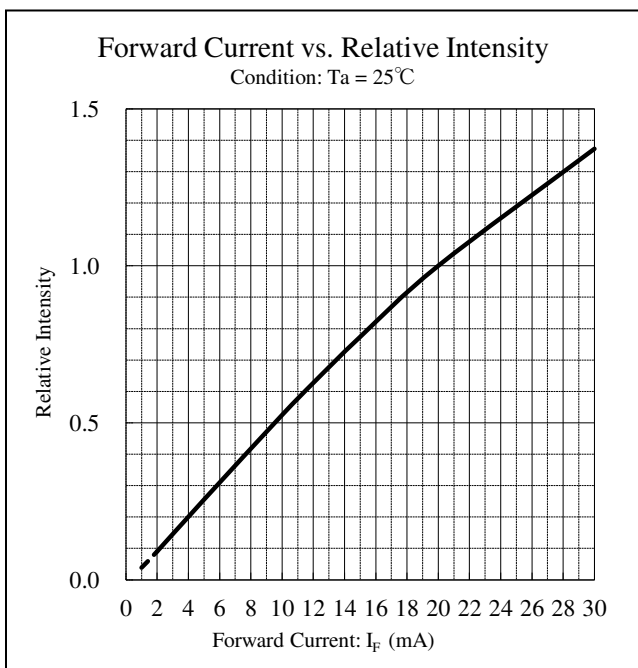
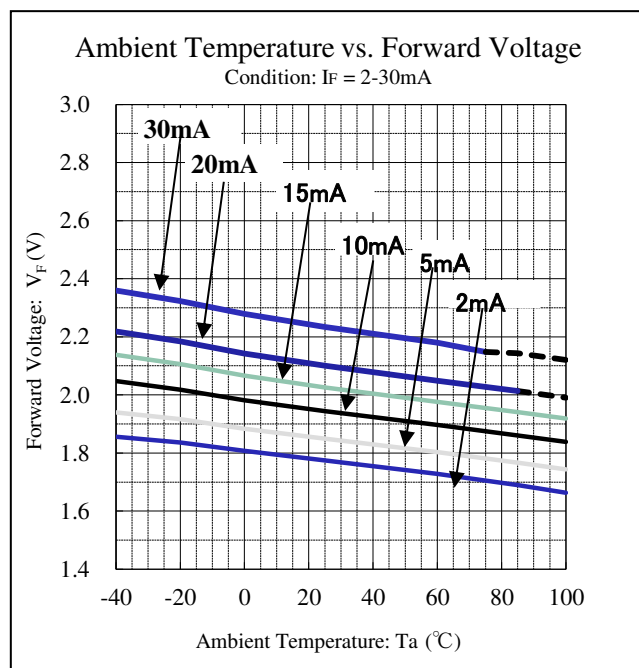
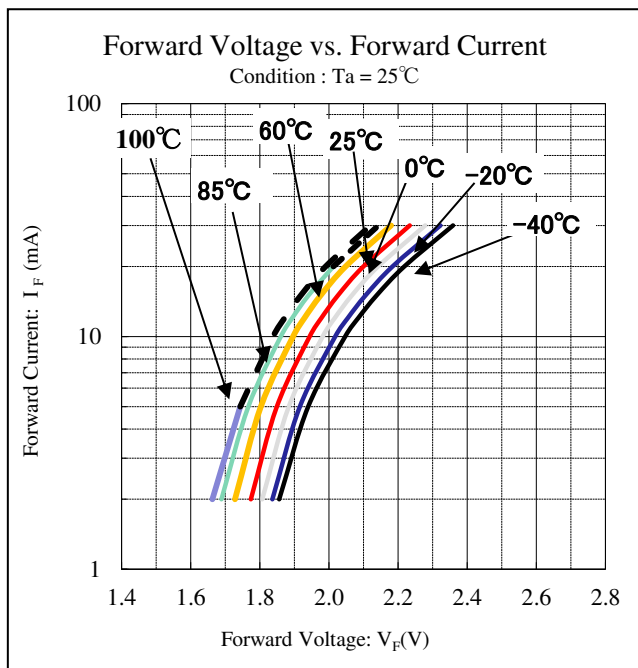

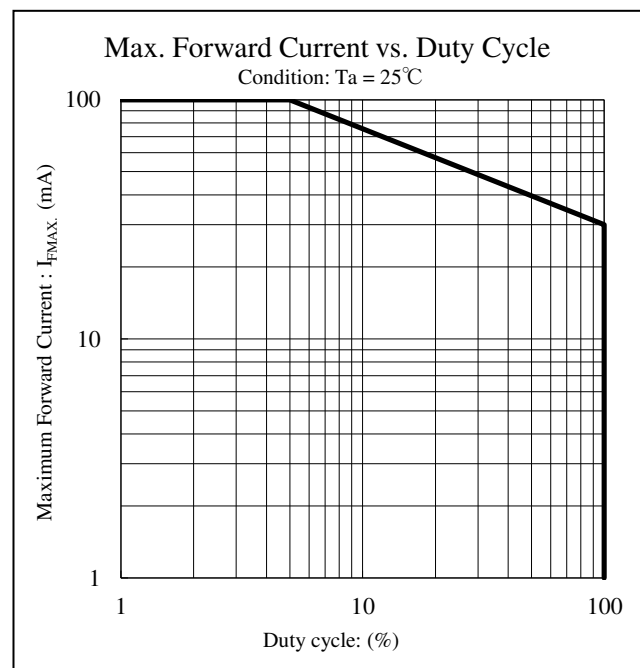
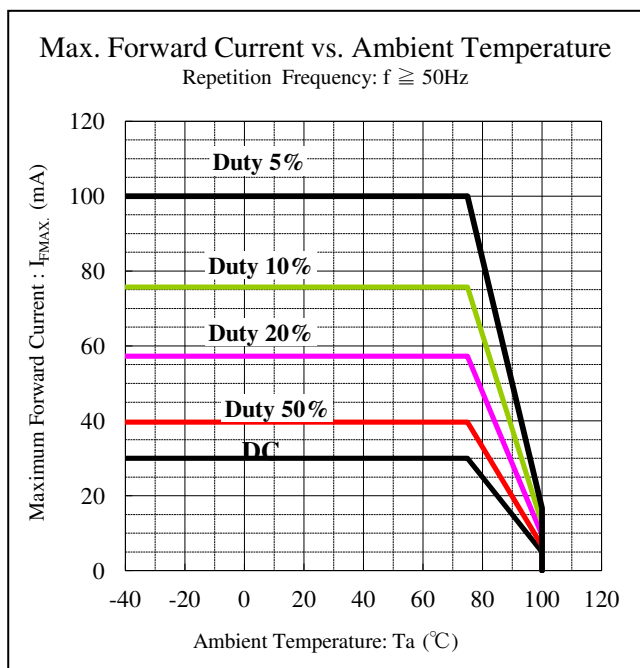
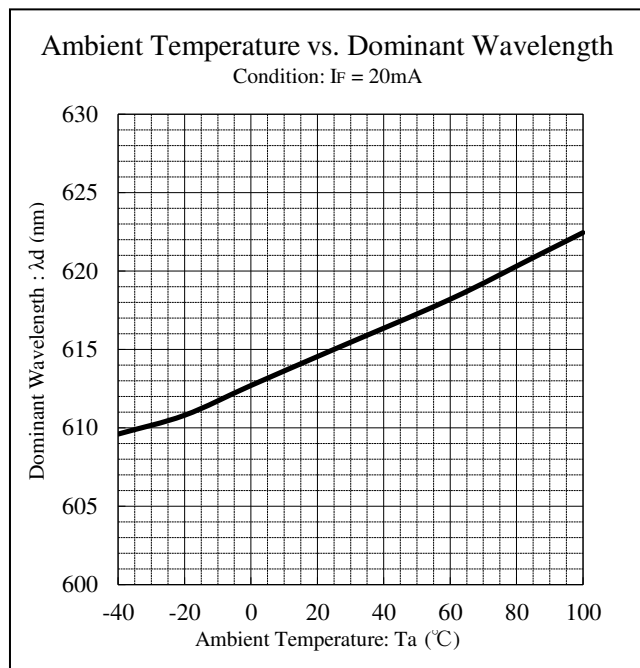
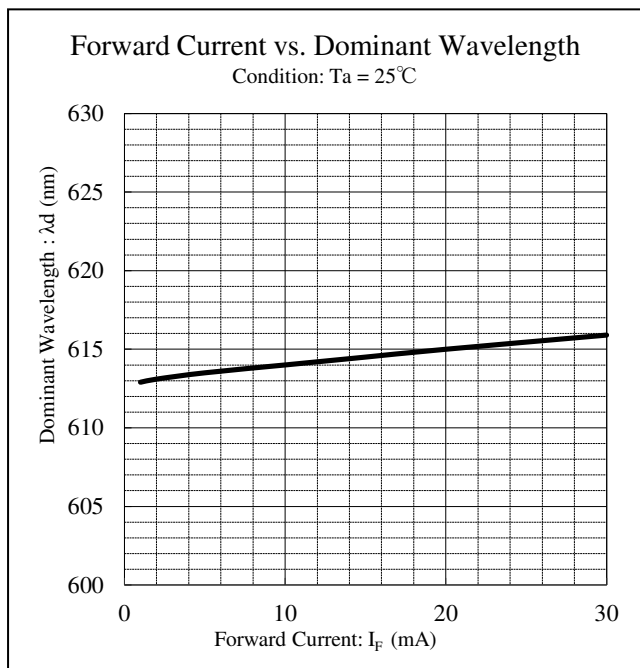

Soldering condition

VJDV1104P-4D13A-TR

【Soldering Precaution】

(acc.to:EIAJ-4701/300)

1. Heat stress during soldering will influence the reliability of LEDs, however that effect will vary on heating method. Also, if components of varying shape are soldered together, it is recommended to set the soldering pad temperature according to the component most vulnerable to heat (e.g., surface mount LED).
2. LED parts including the resin are not stable immediately after soldering (when they are not at room temperature), any mechanical stress may cause damage to the product. Please avoid such stress after soldering, especially stacking of the boards which may cause the boards to warp and any other types of friction with hard materials.
3. Recommended temperature profile for the Reflow soldering is listed as the temperature of the resin surface. Temperature distribution varies on heating method, PCB material, other components in the assembly, and mounting density.
Please do not repeat the heating process in Reflow process more than twice.

【Recommended Reflow Soldering Condition】

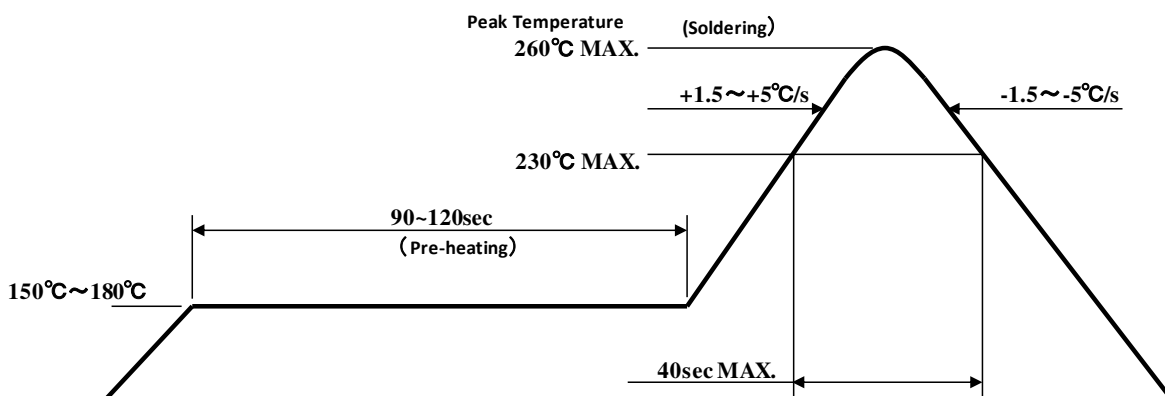

Notes 1 Temperature Profile for the reflow should be set to the surface temperature of resin which is on the top of LED. This should be the maximum temperature for soldering. Lowering the heating temperature and decreasing heating time is very effective in achieving higher reliability.

Notes 2 The reflow soldering process should be done up to twice(2 times Max). When second process is performed, interval between first and second process should be as short as possible to prevent absorption of moisture to resin of LED. The second soldering process should not be done until LEDs have returned to room temperature (by nature-cooling) after first soldering process.

Soldering condition

VJDV1104P-4D13A-TR

4. If soldering manually, Stanley recommends using a soldering iron equipped with temperature control. During the actual soldering process, make sure that the soldering iron never touches the LED itself, and avoid the LED's electrode heating temperature reaching above the heating temperature of the solder pad. All repairs must be performed only once in the same spot, and please avoid reusing components.
5. In soldering process, immediately after iron tip is cleaned, please make sure that the soldering iron reaches the appropriate temperature before using. Also, please avoid applying any types of pressure to the soldered components before the solder has been cooled and hardened, as it may deteriorate solder performance and solder quality.

【Recommended Manual Soldering Condition】

Temperature of Iron Tip	350°C MAX.
Soldering Duration, Time	3sec. Max., 1 time

6. When using adhesive material for tentative fixatives, thermosetting resin or Ultraviolet radiation (UV) setting resin with heat shall be recommended.
《The curing condition, Temperature: 150°C Max./Time: 120sec. Max.》
7. Flow soldering (dip soldering) is not recommended for this product.
8. Isopropyl alcohol is recommended for cleaning. Some chemicals, including Freon substitute detergent could corrode or affect the optical characteristics of the lens or the casing surface. Please review the reference chart below for cleaning. Cleaning with ultrasonic shall not be recommended.

Cleaning agents	Recommended / Not recommended
Isopropyl alcohol	✓ Recommended
Ethyl alcohol	✓ Recommended
Pure water	✓ Recommended
Trichloroethylene	x Not recommended
Chloroethene	x Not recommended
Acetone	x Not recommended
Thinner	x Not recommended

【 Other Precautions 】

1. Stanley LED Lamps have semiconductor characteristics and are designed to ensure high reliability. However, the performance may vary depending on usage conditions.
2. Absolute Maximum Ratings are set to prevent LED lamps from failing due to excess stress(temperature, current, voltage, etc.). Usage conditions must not exceed the ratings for a moment, nor do reach one item of absolute maximum rating s simultaneously.
3. In order to ensure high reliability from LED Lamps, variable factors that arise in actual usage conditions should be taken it to account for designing. (Derating of TYP., MAX Forward Voltage, etc.)
4. Please insert Straight Protective Resistors into the circuit in order to stabilize LED operation and to prevent the device from igniting due to excess current.
5. Please avoid using the products with materials and products that contain sulfur and chorine element which will decrease the reliability of LED. Please keep LED in desiccator to protect them from corrosive gas regardless of whether mounting is finished or not. Also please make sure there is no gas occurs around or gas inflows from outside when using LED.
6. Please check the actual performance in the assembly because the Specification Sheets are described for LED device only.
7. Please refrain from looking directly at the light source of LED at high output, as it may harm your vision.
8. The products are designed to operate without failure in recommended usage conditions. However, please take the necessary precautions to prevent fire, injury, and other damages should any malfunction or failure arise
9. The products are manufactured to be used for ordinary electronic equipment. Please contact our sales staff beforehand when exceptional quality and reliability are required, and the failure or malfunction of the products might directly jeopardize life or health (such as for airplanes, aerospace, transport equipment, medical applications, nuclear reactor control systems and so on).
10. The formal specification sheets shall be valid only by exchange of documents signed by both parties.

This product is baked (moisture removal) before packaging, and is shipped in moisture-proof packaging (as shown below) to minimize moisture absorption during transportation and storage. However, with regard to storing the products, Stanley recommends the use of dry-box under the following conditions is recommended. Moisture-proof bag as the packaging is made of anti-static material but packaging box is not.

【Recommended Storage Condition / Products Warranty Period】

Temperature	+5~30°C
Humidity	Under 70%

In the case of the package unopened, **6 months under 【 Recommended Storage Condition 】**. Please avoid rapid transition from low temp. condition to high temp. condition and storage in corroding and dusty environment.

【Time elapsed after Package Opening.】

The package should not be opened until immediately prior to its use, and please keep the time frame between package opening and soldering which is **【maximum 168h.】** If the device needs to be soldered twice, both soldering must be completed within the 168h.

If any components should remain after their use, please seal the package and store them under the conditions described in the **【 Recommended Storage Condition 】**.

This product must be required to perform baking process (moisture removal) for **at least 24h,not exceed for 72h, at 60±5 degrees Celsius** if following conditions apply.

1. In the case of silica gel (blue) which indicates the moisture level within the package, changes or loses its blue color.
2. In the case of time is passed for 168h after the package is opened once.

Baking process should be performed after LED having been taken out of the package.

Baking may be performed in the tape-reel form, however if it is performed with the reel stacked over one another, it may cause deformation of the reels and taping materials and later obstruct mounting. Please handle only once it has returned to room temperature. Provided that, baking process shall be 2 times MAX.

【Moisture-proof Packaging Specification】

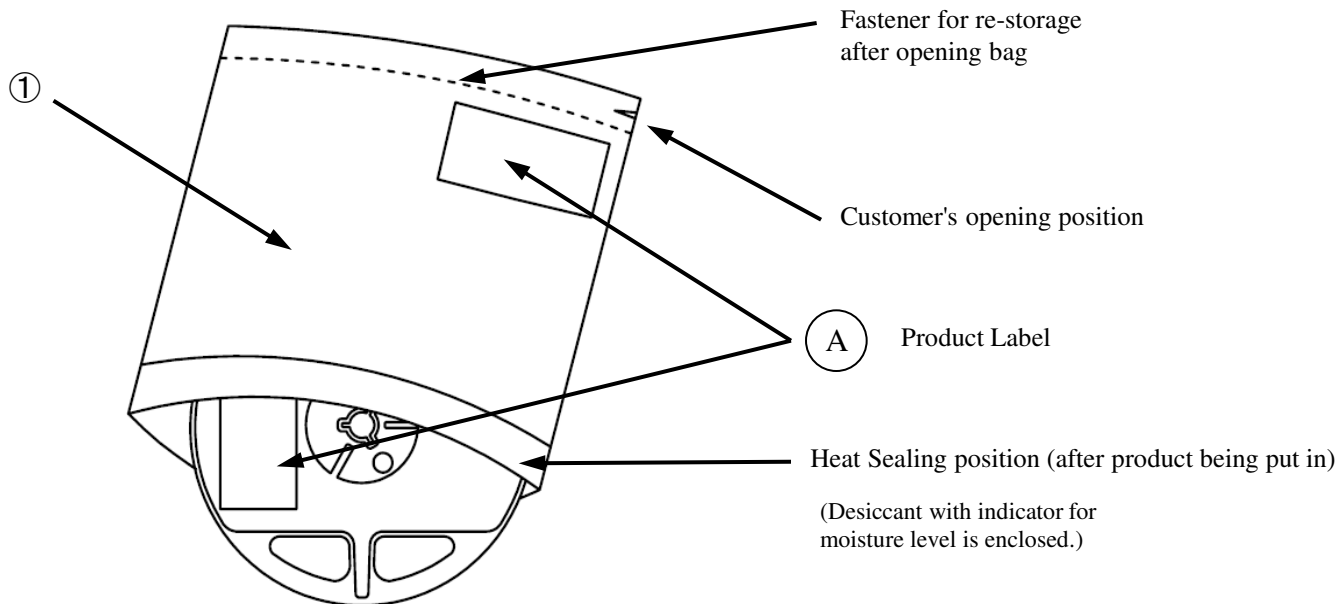

NO.	PART NAME	MATERIAL	REMARKS
①	Moisture-proof bag with Aluminum layer	PET+Al+PE	with ESD protection

【Flow Chart-package Opening to Mounting】

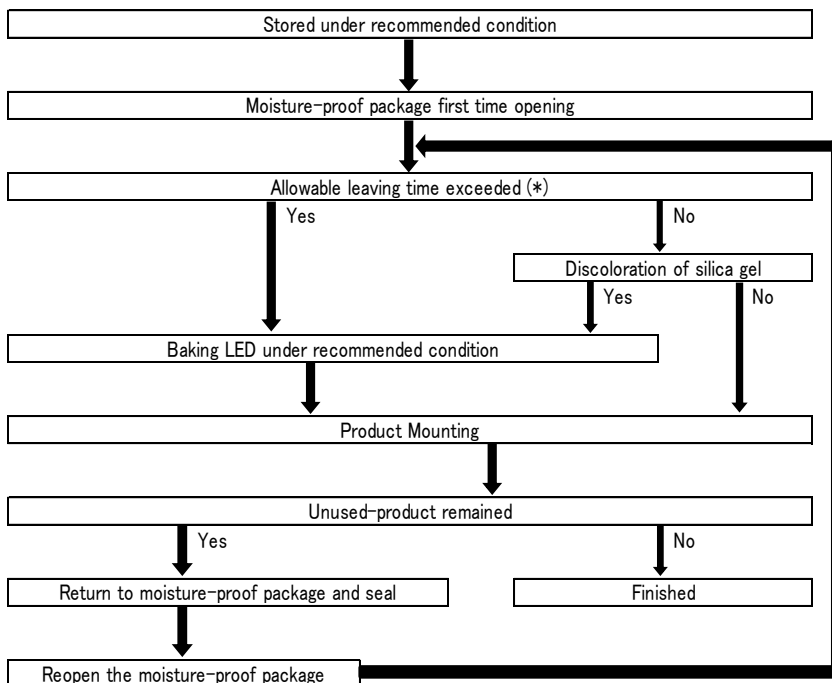

Allowable leaving time means the maximum allowable leaving time after opening package, which depends on each LED type.

The allowable leaving time should be calculated from the first opening of package to the time when soldering process is finished.

When judging if the allowable leaving time has exceeded or not, please subtract the soldering time after reopening. The allowable leaving time after reopening should be calculated from the first opening of package, or from the time when baking process is finished.

Packaging Specifications

VJDV1104P-4D13A-TR

【 Packing box 】

(RoHS2 / ELV Compliant)

Box TYPE	Outline dimension L × W × H (mm)	Capacity of the box
Type A	280 × 265 × 45	3 reels
Type B	310 × 235 × 265	15 reels
Type C	440 × 310 × 265	30 reels

The above measure is all the reference value.

Box for shipment is selected out of the above table, according to the shipping quantity.

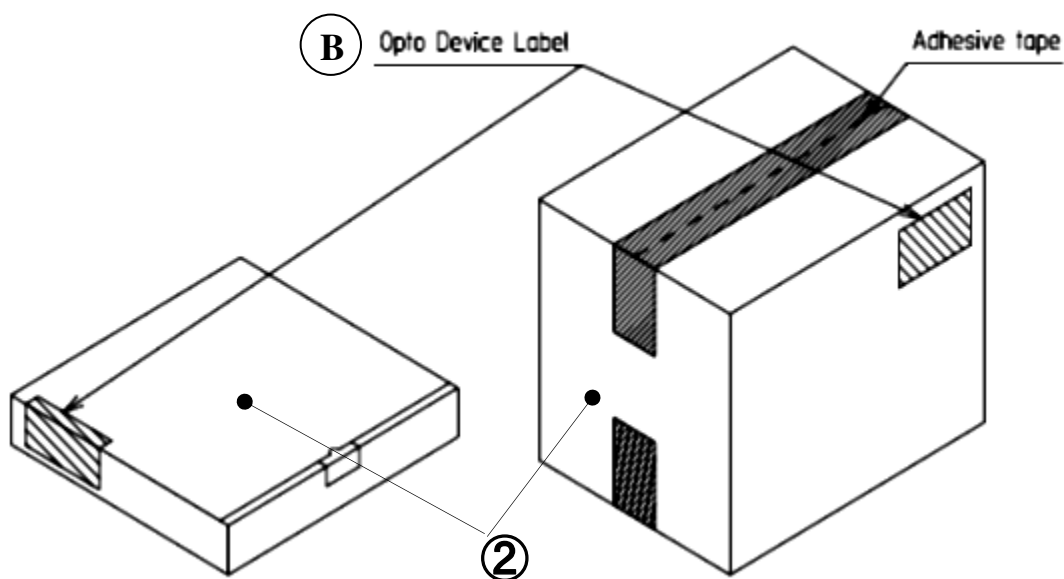

Type A

Material / box : Cardboard C5BF

Type B,C

Material / box : Cardboard K5AF

Partition : Cardboard K5AF

No.	PART NAME	MATERIAL	REMARKS
②	Packing Box	Corrugated Cardboard	without ESD protection

【Label Specification】

(acc.to JIS-X0503(Code-39))

A Product label

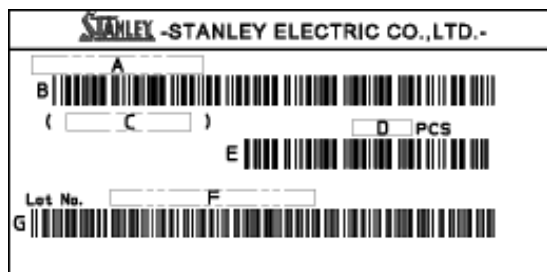

- A. Parts number
- B. Bar-code for parts number
- C. Parts code (In-house identification code for each parts number)
- D. Packed parts quantity
- E. Bar-Code for packed parts quantity
- F. Lot number & Rank
(refer to Lot Number Notational System for details)
- G. Bar-Code for Lot number & Rank

B Opto device label

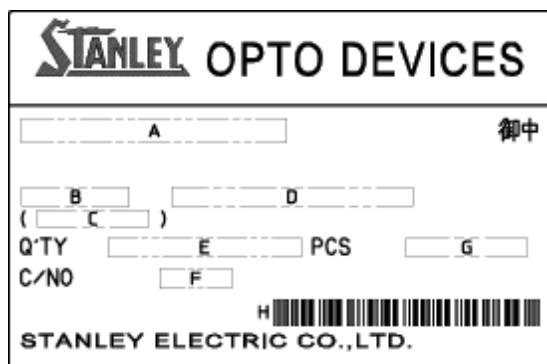

- A. Customer Name
- B. Parts Type
- C. Parts Code
- D. Parts Number
- E. Packed Parts Quantity
- F. Carton Number
- G. Shipping Date
- H. Bar-Code for In-house identification Number

<Remarks> Bar-code font : acc.to Code-39(JIS-X0503)

Taping and Reel Specifications

VJDV1104P-4D13A-TR

(acc.to JIS-C0806-03)

【Appearance】

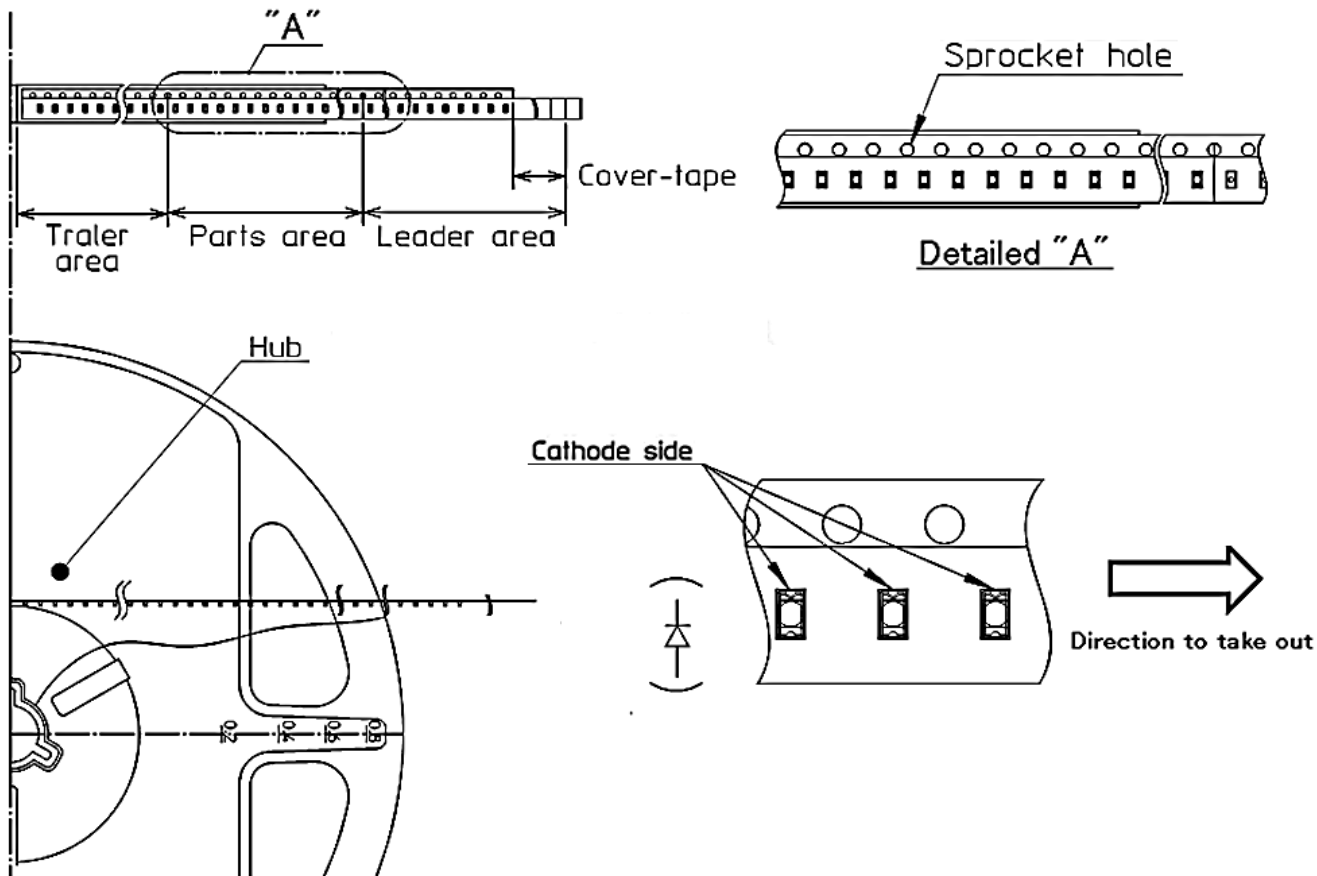

Note "-TR" means cathode side of LEDs should be placed on the sprocket-hole side.

Items		Specifications	Remarks
Leader area	Cover-tape	Cover-tape shall be longer than 320mm without carrier-tape	The end of cover-tape shall be held with adhesive tape.
	Carrier-tape	Empty pocket shall be more than 25 pieces.	Please refer to the above figure for Taping & reel orientation .
Trailer area		Empty pocket shall be more than 40 pieces.	The end of taping shall be inserted into a slit of the hub.

Taping and Reel Specifications

VJDV1104P-4D13A-TR

(acc.to JIS-C0806-03)

【Qty. per Reel】

3,000parts/reel

Minimum Qty. per reel might be 500 parts when getting less than 3,000 parts. In such case, parts of 500-unit-qty. shall be packed in a reel and the qty. shall be identified on the label

【Mechanical strength】

Cover-tape adhesive strength shall be 0.1~1.0N (An angle between carrier-tape and cover-tape shall be 170 deg.) Both tapes shall be so sealed that the contained parts will not come out from the tape when it is bent at a radius of 15mm.

【Others】

Reversed-orientation, Up-side down placing, side placing and out of spec. parts mix shall not be held.
Max qty. of empty pocket per reel shall be defined as follows.

Qty./reel	Max. qty. of empty pocket	Remarks
500	1	-
1,000	1	-
1,500	1	-
2,000	2	No continuance
2,500	2	No continuance
3,000	3	No continuance

Taping and Reel Specifications

VJDV1104P-4D13A-TR

(acc.to JIS-C0806-03)

Unit :mm

【Taping Dimensions】

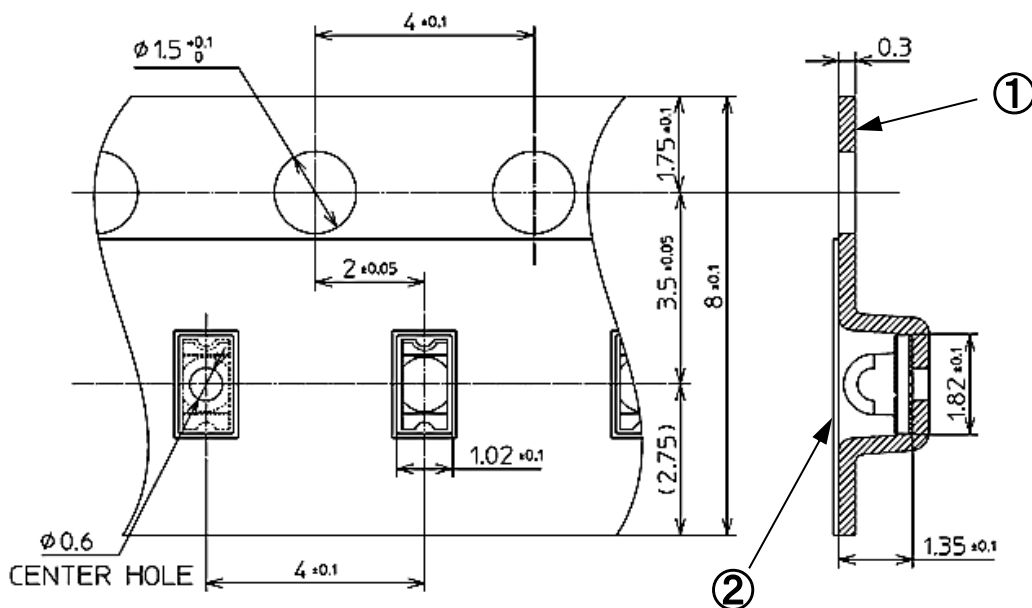

【Reel Dimensions】

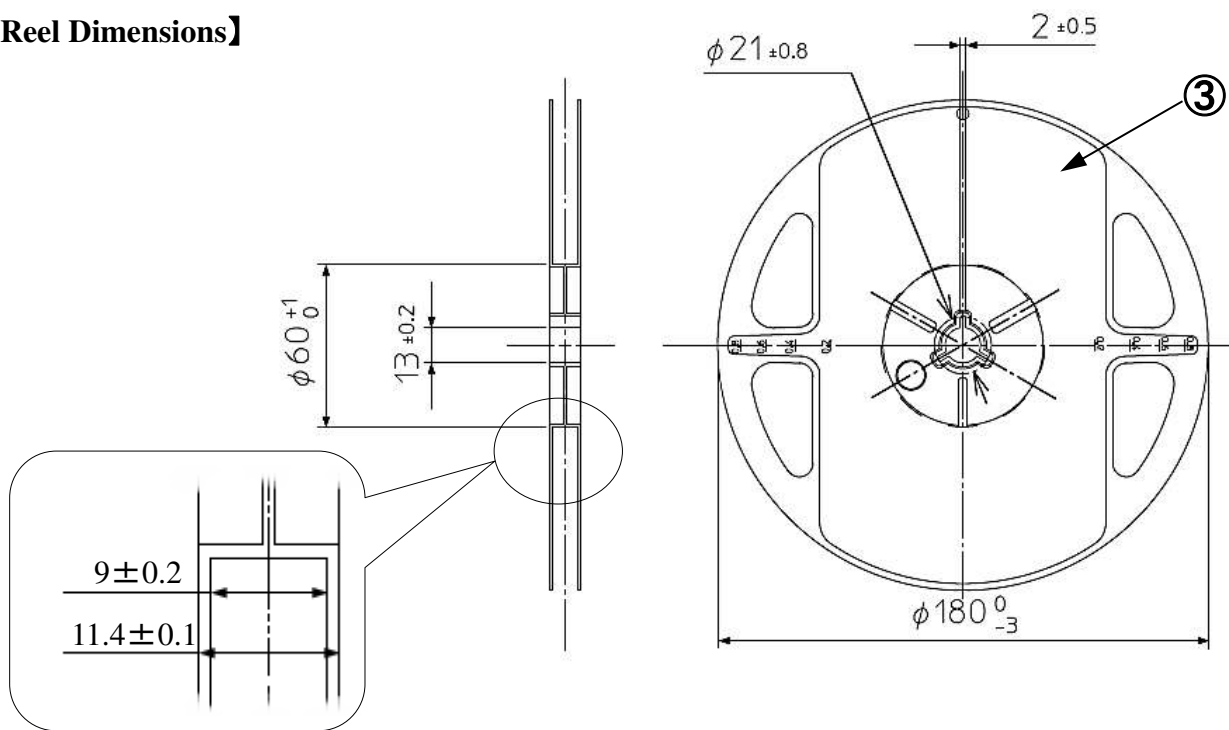

NO.	PART NAME	REMARKS
①	Carrier-tape	Conductive Grade
②	Cover-tape	Anti-Static Grade
③	Carrier-reel	Anti-Static Grade

Lot Number Notational System

VJDV1104P-4D13A-TR

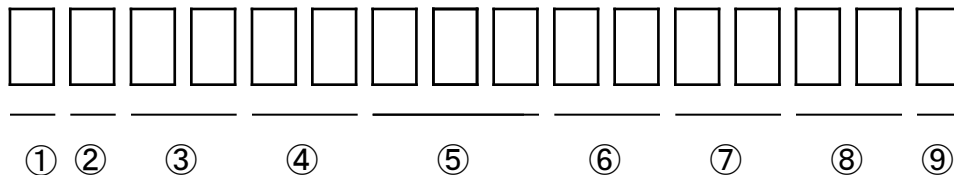

① - 1digit : Production Location (Mark identify alphabet)

② - 1digit : Production Year (Last digit of Production Year 2020→0, 2021→1, 2022→2,···)

③ - 2digits : Production Month (Jan. to Sep. , should be 01,02,03,·····)

④ - 2digits : Production Date

⑤ - 3digits : Serial Number

⑥ - 2digits : Tape and Reel following Number

⑦ - 2digits : Luminous Intensity Rank.

(If luminous intensity rank is 1 digit, "-" shall be dashed on the place for the second digit.

If there is no identified intensity rank, "- -" is used to indicate.)

⑧ - 2digits : Color Rank

(If chromaticity rank is 1 digit, "-" shall be dashed on the place for the second digit.

If there is no identified intensity rank, "- -" is used to indicate.)

⑨ - 1digit : Option Rank (Stanley normally print "-" to indicate)

Correspondence to RoHS2 / ELV instruction VJDV1104P-4D13A-TR

This product is in compliance with RoHS2/ ELV.

Prohibition substance and it's criteria value of RoHS2/ ELV are as follows.

- RoHS2 instruction ... Refer to following 1 to 10.
- ELV instruction ... Refer to following 1 to 4.

No.	Substances	Threshold
1	Lead and its compounds	0.1% (1,000ppm)
2	Mercury and its compounds	0.1% (1,000ppm)
3	Cadmium and its compounds	0.01% (100ppm)
4	Hexavalent chromium compounds	0.1% (1,000ppm)
5	PBB : Polybrominated Biphenyls	0.1% (1,000ppm)
6	PBDE : Polybrominated Biphenyl Ethers	0.1% (1,000ppm)
7	DEHP : Bis (2-ethylhexyl) phthalate	0.1% (1,000ppm)
8	BBP : Butyl benzyl phthalate	0.1% (1,000ppm)
9	DBP : Dibutyl phthalate	0.1% (1,000ppm)
10	DIBP : Diisobutyl phthalate	0.1% (1,000ppm)

Reliability Testing Result

VJDV1104P-4D13A-TR

1. Reliability Testing Result

Test Item	Reference Standard	Test Condition	Duration	Failure
Operating Life	EIAJ ED-4701 /100(101)	Ta=25°C Maximum Rated Current	1,000h	0 / 20
High Temperature Operating Life	EIAJ ED-4701 /100(101)	Ta=85°C Maximum Rated Current ※1	1,000h	0 / 20
Low Temperature Operating Life	EIAJ ED-4701 /100(101)	Ta=-40°C Maximum Rated Current	1,000h	0 / 20
Wet High Temperature Operating Life	EIAJ ED-4701 /100(102)	Ta=60°C Rh=90% Maximum Rated Current	1,000h	0 / 20
High Temperature Storage Life	EIAJ ED-4701 /200(201)	Ta = Tstg max. Maximum Storage Temperature	1,000h	0 / 20
Low Temperature Storage Life	EIAJ ED-4701 /200(202)	Ta = Tstg min. Minimum Storage Temperature	1,000h	0 / 20
Wet High Temperature Storage Life	EIAJ ED-4701 /100(101)	Ta=60°C Rh=90%	1,000h	0 / 20
Thermal Shock	EIAJ ED-4701 /100(105)	Ta= Tstg max. ~ Tstg min. (15min of each)	1,000 cycles	0 / 20
Resistance to Reflow Soldering	EIAJ ED-4701 /300(301)	Moisture Soak : 30°C 70% 72h Preheating : 150~180°C 120sec MAX. Soldering : 260°C 5sec	Twice	0 / 20
Electric Static Discharge(ESD) : HBM	EIAJ ED-4701 /300(304)	C=100pF R2=1.5KΩ ±2000V	once of each polarity	0 / 10
Electric Static Discharge(ESD) : MM	EIAJ ED-4701 /300(304)	C=200pF R2=0Ω±200V	once of each polarity	0 / 10
Vibration, Variable Frequency	EIAJ ED-4701 /400(403)	98.1m/s ² (10G) 100~2000Hz 20min sweep direction	XYZ 2h of each direction	0 / 10

※1 Maximum Rated Current at Maximum Rated Operating Temperature

2. Failure Criteria

Item	Symbol	Condition	Failure Criteria
Luminous Intensity	I _v	I _F = 20mA	Testing Min. Value < Standard Min. Value × 0.5
Forward Voltage	V _F	I _F = 20mA	Testing Max. Value ≥ Standard Max. Value × 1.2
Reverse Current	I _R	V _R = 5V	Testing Max. Value ≥ Standard Max. Value × 2.5
External appearance	-	-	Notable discoloration, deformation and cracking

Special Notice to Customers Using the Products and Technical Information Shown in This Data Sheet

- 1) The technical information shown in the data sheets are limited to the typical characteristics and circuit examples of the referenced products. It does not constitute the warranting of industrial property nor the granting of any license.
- 2) For the purpose of product improvement, the specifications, characteristics and technical data described in the data sheets are subject to change without prior notice. Therefore it is recommended that the most updated specifications be used in your design.
- 3) When using the products described in the data sheets, please adhere to the maximum ratings for operating voltage, heat dissipation characteristics, and other precautions for use. We are not responsible for any damage which may occur if these specifications are exceeded.
- 4) The products that have been described to this catalog are manufactured so that they will be used for the electrical instrument of the benchmark (OA equipment, telecommunications equipment, AV machine, home appliance and measuring instrument).
The application of aircrafts, space borne application, transportation equipment, medical equipment and nuclear power control equipment, etc. needs a high reliability and safety, and the breakdown and the wrong operation might influence the life or the human body. Please consult us beforehand if you plan to use our product for the usages of aircrafts, space borne application, transportation equipment, medical equipment and nuclear power control equipment, etc. except OA equipment, telecommunications equipment, AV machine, home appliance and measuring instrument.
- 5) In order to export the products or technologies described in this data sheet which are under the "Foreign Exchange and Foreign Trade Control Law," it is necessary to first obtain an export permit from the Japanese government.
- 6) No part of this data sheet may be reprinted or reproduced without prior written permission from Stanley Electric Co., Ltd.
- 7) The most updated edition of this data sheet can be obtained from the address below:
<http://www.stanley-components.com/en>