

Master Catalog

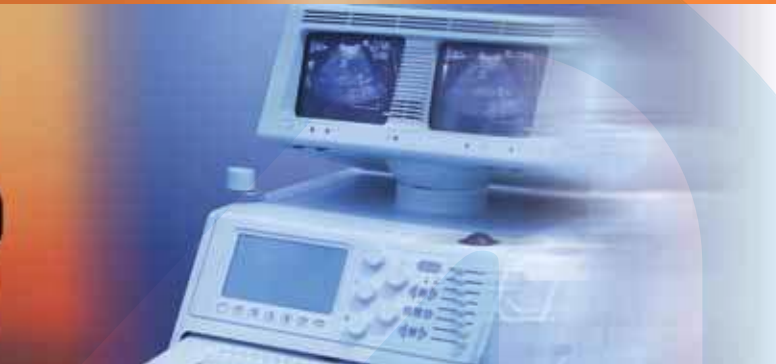

AlphaWire

Cables you trust. Service you deserve.

Contents

Cable Finder Guides	2
Xtra-Guard® Performance Cable	30
Xtra-Guard 1 High-Performance Cable	31
Xtra-Guard 2 Oil- and Abrasion-Resistant Cable	57
Xtra-Guard 3 Direct Burial Cable	71
Xtra-Guard 4 Advanced Temperature and Chemical Performance Cable	79
Xtra-Guard 5 Maximum Temperature and Chemical Performance Cable	94
Xtra-Guard Flex Cable	104
Alpha Wire Industrial Series Cable	124
Series F Continuous Flex Control Cable	127
Series M Control Cable	129
Series P Enhanced Stationary Control Cable	131
Series SF Flexible Servo Cable	133
Series V VFD Control Cable	134
Series XM Flexible Control Cable	136
Manhattan® Electrical Cable	142
Audio/Video Cable	143
Security and Data Cable	174
Plenum Cable	179
Control Cable	188
Instrumentation Cable	203
Computer Cable	216
Coaxial Cable	238
High-Temperature Cable	256
Cordsets	261
Thermocouple Cable	285
Communication, Control, and Industrial Cable	292
Solar Cable	293
Industrial Automation Cable	296
Flexible Motor Supply Cable	304
Communication and Control Cable	305
Flat Cable	371
Hook-Up Wire	378
Dearborn® Marine Cable	426
Kerrigan-Lewis Specialty Wire	444
FIT® Heat-Shrink Tubing	448
FIT Wire Management	482
Technical Information	524
AWG/Metric Conductor Table	524
AWG/Metric Comparison	527
Conductor Color Coding	528
Properties of Common Insulation and Jacket Materials	537
Current Ratings of Alpha Cables	539
Signal Interference and Shielding	540
Common Flexing Applications	543
Agency Approvals	545
Military Specifications	547
Competitive Cross References	549
Temperature Conversions	563
Glossary	565

Make Alpha Wire Your First Choice for Reliable Performance



No matter how demanding the application or environment, you want a cable with the performance and reliability to put your mind at ease. For more than 85 years, Alpha Wire has engineered wire and cable that excel in taming tough applications. From the harsh environment of a factory floor to critical controls on an offshore oil rig, Alpha Wire products work reliably day-in and day-out.

The industry-leading brands you trust

Today's engineers count on Alpha's industry-leading branded products for virtually every application. From telecommunications and factory automation, to medical equipment and wind turbines, you can count on Alpha Wire cable, wire, tubing, and accessories to work the first time, every time.

Whether it's a standard cable solution or a one-of-a-kind specialized design, Alpha's branded products offer decades of proven performance, superior construction, and manufacturing excellence.

Proven in the real world

We design and manufacture every cable to meet the critical demands of real-world applications. Using premium materials, advanced manufacturing, and world-class quality control, we manufacture every cable knowing its operation is critical to an application's success.

Built to last

Every inch of our cable is given the exact same attention to detail, so you get a cable that goes the distance. With Alpha Wire, you know you're getting wire, cable, and heat-shrink tubing with uniform construction and consistent performance characteristics.

Cable Finder Guide

Can't find what you're looking for?
Alpha offers fast turnarounds on custom cables.
Visit our online Cable Design Center™ on
alphawire.com or call for more information.

32 AWG

Multiconductor							
Shielding	Type	Insulation	Jacket	Voltage	Part No. (Typ)	Conductors	Page
Unshielded	C&C, Hi-Fi Stereo	PVC	—	200	1101	3 - 4	368

30 AWG

Multiconductor							
Shielding	Type	Insulation	Jacket	Voltage	Part No. (Typ)	Conductors	Page
Braid	Audio/Video	PE	PVC	300	M3601	1	157
Unshielded	C&C, Hi-Fi Stereo	PVC	—	200	1101	2 - 3	368
Unshielded	Flat Cable, 0.025" CL	PVC	—	150	3582	26 - 60	374

28 AWG

Multiconductor							
Shielding	Type	Insulation	Jacket	Voltage	Part No. (Typ)	Conductors	Page
Unshielded	Flat Cable, 0.050" CL	PVC	—	300	3580	9 - 64	371
	Xtra-Guard Continuous Flex, Data	PVC	PVC	300	86002	2 - 25	115
	Xtra-Guard 1	PVC	PVC	300	5920	2 - 8	32
Foil, Overall	Flat Cable, 0.050 CL, Jacketed	PVC	PVC	150	3590	10 - 26	373
	Xtra-Guard 1	PVC	PVC	300	5926	2 - 8	38
Braid	C&C	PVC	PVC	600	3302	2 - 20	320
	C&C, Miniature Shielded	PVC	PVC	200	1120	2 - 4	365
	Control	PVC	PVC	600	M1411	1 - 12	188
Foil + Braid	C&C	SR-PVC	PVC	300	3463	3 - 50	336
	C&C	FPP	PVC	300	3483	3 - 25	337
	Computer	SR-PVC	PVC	300	M2403	3 - 50	224
	Flat Cable, 0.050" CL, Round to Flat	PVC	PVC	300	3585	25 - 50	372
Supra-Shield Foil + Braid	Xtra-Guard 1	PVC	PVC	300	5932	2 - 8	44
Foil, Overall/ Spiral or Foil/Braid	Xtra-Guard Continuous Flex, Data	PVC	PVC	300	86002CY	2 - 25	116
Multipair							
Shielding	Type	Insulation	Jacket	Voltage	Part No. (Typ)	Pairs	Page
Foil, Overall	Xtra-Guard 1	PVC	PVC	300	5938	2 - 6	52
	C&C	SR-PVC	PVC	300	3472C	2 - 25	350
Foil + Braid	C&C, Low Cap.	PE	PVC	300	6390	2 - 31	352
	C&C, Low Cap.	FPP	PVC	300	3492C	2 - 25	354
	Computer	FPP	PVC	300	M2487	2 - 25	234
	Computer, Low Cap.	PE	PVC	300	M3970	2 - 31	236
Supra-Shield Foil + Braid	Xtra-Guard 1	PVC	PVC	300	5943	2 - 6	54
Foil, Overall/ Spiral or Foil/Braid	Xtra-Guard Continuous Flex, Data	PVC	PVC	300	86401CY	1 - 14	117

Cable Finder Guide

Can't find what you're looking for?
Alpha offers fast turnarounds on custom cables.
Visit our online Cable Design Center™ on
alphawire.com or call for more information.

26 AWG

Multiconductor							
Shielding	Type	Insulation	Jacket	Voltage	Part No. (Typ)	Conductors	Page
Unshielded	Silver Satin Telephone	PP	PVC	150	1604	4 - 8	369
	Xtra-Guard Continuous Flex, Data	PVC	PVC	300	86102	2 - 25	115
	Xtra-Guard 1	PVC	PVC	300	5666	2 - 15	32
Foil, Overall	Xtra-Guard 1	PVC	PVC	300	5674	2 - 15	38
Foil, Overall/Spiral or Foil, Overall/Braid	Xtra-Guard Continuous Flex, Data	PVC	PVC	300	86102CY	2 - 25	116
Braid	C&C	PVC/Nylon	PVC	600	3200	1 - 4	321
	Control	PVC	PVC	600	M1421	1 - 3	188
	High Temperature	PTFE	PTFE	600	M1201	1 - 4	258
Spiral	C&C, Microphone	PE	PVC	1000	1702	1	327
	Microphone	PE	PVC	1000	M3633	1	157
Supra-Shield Foil + Braid	Xtra-Guard 1	PVC	PVC	300	5682	2 - 15	44
Multipair							
Shielding	Type	Insulation	Jacket	Voltage	Part No. (Typ)	Pairs	Page
Foil, Overall	Xtra-Guard 1	PVC	PVC	300	5690	2 - 6	52
Foil, Overall/Spiral or Foil, Overall/Braid	Xtra-Guard Continuous Flex, Data	PVC	PVC	300	86501CY	1 - 14	117
Supra-Shield Foil + Braid	Xtra-Guard 1	PVC	PVC	300	5695	2 - 6	54

25 AWG

Multiconductor							
Shielding	Type	Insulation	Jacket	Voltage	Part No. (Typ)	Conductors	Page
Braid	C&C, Audio	PE	PVC	600	1772	4	328
Foil, Overall and Ind. Pair	C&C	PE	PVC	400	2468	2 + 1 pr	349

24 AWG

Multiconductor							
Shielding	Type	Insulation	Jacket	Voltage	Part No. (Typ)	Conductors	Page
Unshielded	Audio/Video	SR-PVC	PVC	300	M38902	2 - 50	161
	C&C	IRR PVC	PVC	300	6622	2 - 4	312
	Computer	SR-PVC	PVC	300	882402	2 - 6	218
	Computer	SR-PVC	PVC	300	M4501	7 - 37	219
	Xtra-Guard Continuous Flex, Data	PVC	PVC	300	86202	2 - 25	115
	Xtra-Guard Torsional Flex	TPE	PUR	600	87003	3 - 7	119
	Xtra-Guard 1	PVC	PVC	300	5012C	2 - 50	32
	Xtra-Guard 1	PVC	PVC	300	5201	2 - 37	35
	Xtra-Guard 2	PVC	PUR	300	25012	2 - 25	58
	Xtra-Guard 4	TPE	TPE	300	45012	2 - 25	80
	Xtra-Guard 5	FEP	FEP	300	55012	2 - 12	95
Foil, Overall	Audio/Video	PE	PVC	300	M3222	2 - 4	152
	Audio/Video	PE	PVC	300	M13222	2	166
	Audio/Video	SP-PVC	PVC	300	M39024	3 - 50	166
	Audio/Video	PP	PVC	300	M14328	2	170
	C&C	PE	PVC	300	2400C	2	314
	C&C	PVC	PVC	300	1212C	2 - 50	317
	C&C	SR-PVC	PVC	300	6300/3	3 - 50	318
	C&C, Plenum	PVC	PVC	300	58401	2 - 25	363

Cable Finder Guide

Can't find what you're looking for?
Alpha offers fast turnarounds on custom cables.
Visit our online Cable Design Center™ on
alphawire.com or call for more information.

24 AWG

Multiconductor							
Shielding	Type	Insulation	Jacket	Voltage	Part No. (Typ)	Conductors	Page
Foil, Overall	Computer	PVC	PVC	300	1012405	5 - 9	222
	Computer	SR-PVC	PVC	300	M4602	2 - 50	223
	Plenum	PVC	PVC	300	M244837	2 - 4	179
	Plenum	FEP	FEP	300	M64837	2 - 15	182
	Plenum	FEP	PVC	300			
	Security/Data	PVC	PVC	300	M239023	2 - 4	175
	Xtra-Guard 1	PVC	PVC	300	5092C	2 - 70	38
	Xtra-Guard 1	PVC	PVC	300	5399	3 - 27	41
	Xtra-Guard 2	PVC	PUR	300	25092	2 - 25	61
	Xtra-Guard 3	PVC	PE	300	35491	1 - 4	77
	Xtra-Guard 4	TPE	TPE	300	45092	2 - 25	83
	Xtra-Guard 5	FEP	FEP	300	55092	2 - 12	97
	Braid	Audio/Video	PE	PVC	300	M1102	2 - 6
C&C		PVC/Nylon	PVC	600	3210	1 - 4	321
C&C		IRR PVC	PVC	600	7622	2 - 4	325
C&C		PTFE	FEP	600	2831	1 - 3	331
C&C		TFE	Fiberglass	600	2811	1 - 7	332
C&C		PTFE	PTFE	600	2821	1 - 6	334
C&C, Microphone		PE	PVC	3500	1703	1	327
Control		PVC	PVC	600	M1431	1 - 3	188
High Temperature		PTFE	PTFE	600	24RC2S06	2 - 4	256
High Temperature		ETFE	ETFE	600	275002402	2	257
High Temperature		PTFE	PTFE	600	M1211	1 - 4	258
High Temperature		PTFE	FEP	600	72402	2	260
Microphone		PE	PVC	3500	M3605	1	157
Foil + Braid	C&C	SR-PVC	PVC	300	6327	3 - 50	335
	C&C, Low Cap.	FPE	PVC	300	6351	3 - 37	339
	Computer, Low Cap.	FPE	PVC	300	M2456	3 - 37	228
	Computer	SR-PVC	PVC	300	M2438	3 - 50	225
	Computer	SR-PVC	PVC	300	M5500	5 - 60	227
Spiral	C&C, Microphone	PE	PVC	1000	1705	1	327
	Xtra-Guard Torsional Flex	TPE	PUR	600	87003CY	3 - 7	121
Supra-Shield Foil + Braid	Microphone	PE	PVC	1000	M3635	1	157
	Xtra-Guard 1	PVC	PVC	300	5112C	2 - 50	44
	Xtra-Guard 1	PVC	PVC	300	5300C	5 - 48	47
	Xtra-Guard 2	PVC	PUR	300	25112	2 - 50	64
	Xtra-Guard 4	TPE	TPE	300	45112	2 - 25	86
	Xtra-Guard 5	FEP	FEP	300	55112	2 - 12	99
Foil, Overall/Spiral or Foil, Overall/Braid	Xtra-Guard Continuous Flex, Data	PVC	PVC	300	86202CY	2 - 25	116
Multipair							
Shielding	Type	Insulation	Jacket	Voltage	Part No. (Typ)	Pairs	Page
Unshielded	Xtra-Guard 1	PVC	PVC	300	5261C	1 - 77	50
	C&C	LSZH	LSZH	300	5471L	1 - 10	307
Foil, Overall	C&C	SR-PVC	PVC	300	5471	1 - 50	341
	C&C, Low Cap.	HDPE	PVC	300	6083C	3 - 4	345
	C&C, Low Cap.	PE	PVC	300	6301	6 - 12.5	346
	C&C, Low Cap.	FPP	PVC	300	6202C	2 - 25	347
	Computer, Low Cap.	FPP	PVC	300	M39249	2 - 27	233

Cable Finder Guide

Can't find what you're looking for?
Alpha offers fast turnarounds on custom cables.
Visit our online Cable Design Center™ on
alphawire.com or call for more information.

24 AWG

Multipair							
Shielding	Type	Insulation	Jacket	Voltage	Part No. (Typ)	Pairs	Page
Foil, Overall	C&C, Low Cap., Plenum	FEP	PVDF	150	58902	2 - 12.5	366
	C&C, Mid Cap., Plenum	FEP	PVDF	150	58802	2 - 12.5	366
	C&C, Plenum	PVC	PVC	300/150	57602	2 - 6	365
	Computer	SR-PVC	PVC	300	M13190	1 - 50	231
	Plenum	FEP	FEP	300	M613190	1 - 5	186
	Plenum	FEP	PVC	300	M52893	1 - 12.5	185
	Security/Data	PVC	PVC	300	M213191	2 - 4	178
	Xtra-Guard 1	PVC	PVC	300	5491C	1 - 27	52
	Xtra-Guard 2	PVC	PUR	300	25491	1 - 27	67
	Xtra-Guard 4	TPE	TPE	300	45491	1 - 27	90
	Xtra-Guard 5	FEP	FEP	300	55491	1 - 11	102
Foil, Ind. Pairs	C&C, Low Cap., Plenum	FEP	PVDF	150	58602	2 - 4	366
	C&C	PE	PVC	300	6385	3 - 25	360
	C&C	FPP	PVC	300	6073C	3 - 27	370
	Plenum	FEP	PVDF	300	M42891	2 - 18	187
Foil + Braid	C&C	SR-PVC	PVC	300	6362	2 - 25	351
	C&C, Low Cap.	PE	PVC	300	6401	2 - 25	353
	C&C, Low Cap.	FPP	PVC	300	6222C	2 - 25	355
	Computer	SR-PVC	PVC	300	M3446	2 - 15	237
	Computer	SR-PVC	PVC	300	M5650	5 - 37	232
	Computer	FPP	PVC	300	M3420	2 - 25	234
	Computer, Low Cap.	FPP	PVC	300	M3475	2 - 25	235
	Computer, Low Cap.	PE	PVC	300	M3993	1 - 25	236
Foil + Braid, Foil on Ind. Pairs	C&C, Low Cap.	FPE	PVC	300	6316	2 - 25	362
Supra-Shield Foil + Braid	Xtra-Guard 1	PVC	PVC	300	5271C	1 - 51	54
	Xtra-Guard 1	PVC	PVC	300	5330C	5 - 37	56
	Xtra-Guard 2	PVC	PUR	300	25271	1 - 19	69
	Xtra-Guard 3	PVC	PE	300	35272	2	78
	Xtra-Guard 4	TPE	TPE	300	45271	1 - 19	92
	Xtra-Guard 5	FEP	FEP	300	55271	1 - 12	103
Foil, Overall/Spiral or Foil, Overall/Braid	Xtra-Guard Continuous Flex, Data	PVC	PVC	300	86601CY	1 - 14	118

24 + 22 AWG

Multiconductor							
Shielding	Type	Insulation	Jacket	Voltage	Part No. (Typ)	Conductors	Page
Unshielded + Foil	Audio/Video	PVC/PE	PVC	300	M14477	6 - 10	172

23 AWG

Multiconductor							
Shielding	Type	Insulation	Jacket	Voltage	Part No. (Typ)	Conductors	Page
Braid	C&C, Audio	PE	PVC	600	1771	2	328

22 AWG

Multiconductor							
Shielding	Type	Insulation	Jacket	Voltage	Part No. (Typ)	Conductors	Page
Unshielded	Audio/Video	PVC	PVC	300	M13302	2 - 50	143
	Audio/Video	SR-PVC	PVC	300	M33302	2 - 60	161
	C&C	LSZH	LSZH	300	1172L	2 - 10	306
	C&C	PVC	PVC	300	1172C	2 - 60	308
	C&C	IRR PVC	PVC	300	6632	2 - 4	312
	Computer	SR-PVC	PVC	300	882202	2 - 60	218
	Computer	SR-PVC	PVC	300	M4508	2 - 37	219
	Control	PVC	PVC	300	M39071	2 - 3	199

Cable Finder Guide

Can't find what you're looking for?
Alpha offers fast turnarounds on custom cables.
Visit our online Cable Design Center™ on
alphawire.com or call for more information.

Multiconductor								
Shielding	Type	Insulation	Jacket	Voltage	Part No. (Typ)	Conductors	Page	
Unshielded	Security/Data	PVC	PVC	300	M213302	2 - 8	174	
	Xtra-Guard Continuous Flex, Data	PVC	PVC	300	86302	2 - 25	115	
	Xtra-Guard Torsional Flex	TPE	PUR	600	87103	3 - 7	119	
	Xtra-Guard 1	PVC	PVC	300	5002C	2 - 60	33	
	Xtra-Guard 1	PVC	PVC	300	5210	2 - 37	35	
	Xtra-Guard 1	PVC	PVC	600	5402	2 - 19	36	
	Xtra-Guard 2	PVC	PUR	300	25002	2 - 25	58	
	Xtra-Guard 3	PVC	PE	300	35002	2 - 15	72	
	Xtra-Guard 4	TPE	TPE	300	45002	2 - 25	80	
	Xtra-Guard 5	FEP	FEP	300	55002	2 - 12	95	
Foil, Overall	Audio/Video	PE	PVC	300	M3226	2 - 4	152	
	Audio/Video	PE	PVC	300	M13226	2 - 3	166	
	Audio/Video	PVC	PVC	300	M13229	2	167	
	Audio/Video	PP	PVC	300	M4325	2	170	
	C&C	PE	PVC	300	2401C	2 - 4	314	
	C&C	PP	PVC	300	2460C	2 - 4	316	
	C&C	PVC	PVC	300	1292C	2 - 50	317	
	C&C, Plenum	PVC	PVC	300	58113	3 - 25	363	
	Computer	SR-PVC	PVC	300	M4633	2 - 50	223	
	Control	PVC	PVC	300	M39113	2 - 3	202	
	Plenum	PVC	PVC	300	M244800	2 - 10	179	
	Plenum	FEP	PVDF	300	M413226	2	181	
	Plenum	FEP	FEP	300	M64800	2 - 15	182, 183	
	Security/Data	PVC	PVC	300	M113226	2 - 3	175	
	Xtra-Guard 1	PVC	PVC	300	5192C	2 - 70	39	
	Xtra-Guard 1	PVC	PVC	300	5580	2 - 37	41	
	Xtra-Guard 1	PVC	PVC	600	5410	2 - 12	42	
	Xtra-Guard 2	PVC	PUR	300	25192	2 - 50	61	
Xtra-Guard 3	PVC	PE	300	35192	2 - 60	73		
Xtra-Guard 4	TPE	TPE	300	45192	2 - 25	83		
Xtra-Guard 5	FEP	FEP	300	55192	2 - 12	97		
Foil, Overall/Spiral or Foil, Overall/Braid	Xtra-Guard Continuous Flex, Data	PVC	PVC	300	86302CY	2 - 25	116	
Braid	Audio/Video	PE	PVC	300	M1112	2 - 8	146	
	Audio/Video	PVC	PVC	300	M3202	2 - 4	164	
	C&C	PVC/Nylon	PVC	600	3220	1 - 8	321	
	C&C	PVC	PVC	300	1735	1 - 4	323	
	C&C	IRR PVC	PVC	600	7631	2 - 4	325	
	C&C	PTFE	FEP	600	2834	1 - 3	331	
	C&C	TFE	Fiberglass	600	2814/2	2 - 6	332	
	C&C	PTFE	PTFE	600	2824	1 - 6	334	
	C&C, Microphone	PE	PVC	1000	1710	2	327	
	Control	PVC	PVC	600	M1441	1 - 10	189	
	High Temperature	PTFE	PTFE	600	22RC2S06	2 - 4	256	
	High Temperature	ETFE	ETFE	600	275002201	1 - 4	257	
	High Temperature	PTFE	PTFE	600	M1221	1 - 4	258	
	High Temperature	PTFE	FEP	600	72203	3	259	
	Microphone	PVC	PVC	300	M14461	2	158	
	Foil + Braid	C&C	SR-PVC	PVC	300	6339	3 - 50	338
		Computer	SR-PVC	PVC	300	M2473	3 - 50	226
		Computer	SR-PVC	PVC	300	M5509	5 - 60	227

Cable Finder Guide

Can't find what you're looking for?
Alpha offers fast turnarounds on custom cables.
Visit our online Cable Design Center™ on
alphawire.com or call for more information.

22 AWG

Multiconductor								
Shielding	Type	Insulation	Jacket	Voltage	Part No. (Typ)	Conductors	Page	
Spiral	C&C	PVC	PVC	300	2254	1 - 6	319	
	Xtra-Guard Torsional Flex	TPE	PUR	600	87103CY	3 - 7	121	
	Audio/Video	PVC	PVC	300	M3261	1 - 6	162	
Supra-Shield Foil + Braid	Xtra-Guard 1	PVC	PVC	600	5504	4 - 12	48	
	Xtra-Guard 2	PVC	PUR	300	25102	2 - 50	64	
	Xtra-Guard 3	PVC	PE	300	35102	2 - 15	76	
	Xtra-Guard 4	TPE	TPE	300	45102	2 - 25	86	
	Xtra-Guard 5	FEP	FEP	300	55102	2 - 12	99	
Unshielded + Braid	C&C	PVC	PVC	300	1243	3 - 5	313	
Unshielded/Foil	Audio/Video	PVC	PVC	300	M4475	3 - 4	171	
Unshielded/Foil	Audio/Video	PP	PVC	300	M14474	2	171	
Multipair								
Shielding	Type	Insulation	Jacket	Voltage	Part No. (Typ)	Pairs	Page	
Unshielded	Audio/Video	PVC	PVC	300	M13001	1 - 27	150, 151	
	C&C	PVC	PVC	300	1300C	1 - 27	340	
	Security/Data	PVC	PVC	300	M2210	2 - 4	176	
	Xtra-Guard 1	PVC	PVC	300	5021C	1 - 15	50	
	Xtra-Guard 5	FEP	FEP	300	55201	1 - 12	101	
Foil, Overall	C&C	PVC	PVC	300	5902C	2 - 19	342	
	C&C	PVC	PVC	150	2211C	1 - 27	343	
	C&C	PVC	PVC	300	6417	1 - 51	344	
	C&C	FPP	PVC	300	6072C	2	370	
	C&C, Low Cap.	FPP	PVC	300	6212C	2 - 25	347	
	Computer	SR-PVC	PVC	300	M4779	1 - 27	231	
	Computer	PVC	PVC	300	M3191	51, 102	230	
	Computer	PP	PVC	300	M3190	38	231	
	Control	PVC	PVC	300	M39130	2 - 51	201	
	Fieldbus, High-Speed	FPO	PVC	300	6461	1	300	
	Fieldbus, Type B	PO	PVC	300	6460	1	299	
	Instrumentation	PVC	PVC	300	5610B2201	1	204	
	Instrumentation	PVC	PVC	300	5640B2201	1	210	
	Security/Data	PVC	PVC	300	M213222	2 - 4	178	
	Xtra-Guard 1	PVC	PVC	300	5481C	1 - 27	53	
	Xtra-Guard 2	PVC	PUR	300	25481	1 - 19	67	
	Xtra-Guard 3	PVC	PE	300	35481	1 - 5	77	
	Xtra-Guard 4	TPE	TPE	300	45481	1 - 15	90	
	Xtra-Guard 5	FEP	FEP	300	55481	1 - 12	102	
	Foil, Ind. Pairs	Audio/Video	PP	PVC	300	M39039	6 - 15	154
		C&C	LSZH	LSZH	300	2466L	2 - 12	307
		C&C	PVC	PVC	300	6052C	2 - 27	356
		C&C	PP	PVC	300	6010C	3 - 27	357
C&C		PVC	PVC	300	6434	2 - 51	358	
Control		PVC	PVC	300	M39147	2 - 51	200	
Plenum		PVC	PVC	300	M24473	2 - 6	184	
Security/Data		PVC	PVC	300	M213102	2 - 6	177	
Foil, Overall and Pairs		C&C, Mid Cap., Plenum	FEP	PVDF	150	58612	2 - 6	367
Foil, Overall/Spiral or Foil, Overall/Braid	Xtra-Guard Continuous Flex, Data	PVC	PVC	300	86701CY	1 - 14	118	
	C&C	SR-PVC	PVC	300	6373	2 - 25	351	
Foil + Braid	Computer	SR-PVC	PVC	300	M5660	5 - 37	232	
	Computer	SR-PVC	PVC	300	M3433	2 - 25	237	
	PROFIBUS-DP	HDPE	PVC	300	6462	1	301	
	RS-485	HDPE	PVC	600	6453	1 - 4	302	

Cable Finder Guide

Can't find what you're looking for?
Alpha offers fast turnarounds on custom cables.
Visit our online Cable Design Center™ on
alphawire.com or call for more information.

22 AWG

Multipair							
Shielding	Type	Insulation	Jacket	Voltage	Part No. (Typ)	Pairs	Page
Supra-Shield Foil + Braid	Xtra-Guard 1	PVC	PVC	300	5121C	1 - 27	55
	Xtra-Guard 1	PVC	PVC	300	5340C	2 - 37	56
	Xtra-Guard 2	PVC	PUR	300	25121	1 - 15	69
	Xtra-Guard 3	PVC	PE	300	35121	1 - 9	78
	Xtra-Guard 4	TPE	TPE	300	45121	1 - 19	92
	Xtra-Guard 5	FEP	FEP	300	55121	1 - 12	103

22 AWG

Triads							
Shielding	Type	Insulation	Jacket	Voltage	Part No. (Typ)	Conductors	Page
Foil	Instrumentation	PVC	PVC	300	5640B2201	1	210

22 AWG + 18 AWG

Multiconductor							
Shielding	Type	Insulation	Jacket	Voltage	Part No. (Typ)	Conductors	Page
Unshielded	Audio/Video	PVC	PVC	300	M4406	6	173
Unshielded	C&C	PVC	PVC	300	1826C	6 - 8	313

20 AWG

Multiconductor							
Shielding	Type	Insulation	Jacket	Voltage	Part No. (Typ)	Conductors	Page
Unshielded	Audio/Video	PVC	PVC	300	M13404	2 - 15	143
	Audio/Video	PVC	PVC	300	M33402	2 - 19	159
	C&C	LSZH	LSZH	300	1895L	2 - 6	306
	C&C	PVC	PVC	300	1895C	2 - 15	309
	C&C	IRR PVC	PVC	300	6642	2 - 4	312
	Computer	PVC	PVC	300	882002	2 - 15	216
	Computer	SR-PVC	PVC	300	M4517	2 - 37	219
	Control	PVC	PVC	300	M39073	2 - 3	199
	Security/Data	PVC	PVC	300	M213402	2 - 4	174
	Xtra-Guard Continuous Flex, Control	PVC	PVC	600	85003	3 - 34	111
	Xtra-Guard Standard Flex	PVC	PVC	600	65002	2 - 25	106
	Xtra-Guard Torsional Flex	TPE	PUR	600	87203	3 - 7	121
	Xtra-Guard 1	PVC	PVC	300	5052C	2 - 50	33
	Xtra-Guard 1	PVC	PVC	300	5220	2 - 37	35
	Xtra-Guard 1	PVC	PVC	600	5413	2 - 25	36
	Xtra-Guard 2	PVC	PUR	300	25052	2 - 70	58
	Xtra-Guard 3	PVC	PE	300	35052	2 - 15	72
	Xtra-Guard 4	TPE	TPE	300	45052	2 - 15	80
	Xtra-Guard 5	FEP	FEP	300	55052	2 - 12	95
	Foil, Overall	Audio/Video	PP	HDPE	300	M39047	2 - 15
Audio/Video		PE	PVC	300	M3232	2 - 4	152
Audio/Video		PE	PVC	300	M13232	2 - 3	167
Audio/Video		PVC	PVC	300	M14429	2	169
C&C		PE	PVC	300	2411C	2 - 4	314
C&C		PE	PVC	300	1243/3C	3	316
C&C		PVC	PVC	300	2465C	4	316
C&C, Plenum		PVC	PVC	300	58421	2 - 6	363
Computer		PVC	PVC	300	M4660	2 - 50	220
Control		PVC	PVC	300	M39115	2 - 3	202

Cable Finder Guide

Can't find what you're looking for?
Alpha offers fast turnarounds on custom cables.
Visit our online Cable Design Center™ on
alphawire.com or call for more information.

20 AWG

Multiconductor							
Shielding	Type	Insulation	Jacket	Voltage	Part No. (Typ)	Conductors	Page
Foil, Overall	Plenum	PVC	PVC	300	M244816	2 - 4	179
	Plenum	FEP	FEP	300	M64816	2 - 10	183
	Security/Data	PVC	PVC	300	M113232	2 - 3	175
	Xtra-Guard 1	PVC	PVC	300	5462C	2 - 50	39
	Xtra-Guard 1	PVC	PVC	300	5560	2 - 19	41
	Xtra-Guard 1	PVC	PVC	600	5420	2 - 12	42
	Xtra-Guard 2	PVC	PUR	300	25462	2 - 50	61
	Xtra-Guard 3	PVC	PE	300	35462	2 - 25	73
	Xtra-Guard 4	TPE	TPE	300	45462	2 - 40	83
	Xtra-Guard 5	FEP	FEP	300	55462	2 - 12	97
Braid	Audio/Video	PE	PVC	300	M1122	2 - 20	146
	Audio/Video	PVC	PVC	300	M3206	2 - 12	164
	C&C	PVC/Nylon	PVC	600	3230	10 4	322
	C&C	PVC	PVC	300	1741C	2 - 4	323
	C&C	IRR PVC	PVC	600	7661	2 - 4	325
	C&C	PE	PVC	600	1712	2 - 20	329
	C&C	PTFE	FEP	600	2837/2	2 - 3	331
	C&C	TFE	Fiberglass	600	2817/2	2 - 6	332
	C&C	PTFE	PTFE	600	2827	1 - 6	334
	C&C, Microphone	PE	PVC	4000/1000	1706	1 - 2	327
	Control	PVC	PVC	600	M1451	1 - 4	189
	High Temperature	PTFE	PTFE	600	20RC2S06	2 - 4	256
	High Temperature	ETFE	ETFE	600	275002001	1 - 4	257
	High Temperature	PTFE	PTFE	600	M1231	1 - 4	258
	High Temperature	PTFE	FEP	600	72001	1	260
	Microphone	PE	PVC	4000	M3611	1	157
	Xtra-Guard Standard Flex	PVC	PVC	600	65003CY	3 - 25	109
Xtra-Guard Continuous Flex, Control	PVC	PVC	600	85003CY	3 - 25	113	
Foil + Braid	Computer	SR-PVC	PVC	300	M5518	5 - 60	227
	Computer	PVC	PVC	300	M5360	2 - 50	229
Spiral	C&C	PVC	PVC	300	2256	1 - 6	319
	Xtra-Guard Torsional Flex	TPE	PUR	600	87203CY	3 - 7	121
	Audio/Video	PVC	PVC	300	M3271	1 - 6	162
Supra-Shield Foil + Braid	Xtra-Guard 1	PVC	PVC	300	5152C	2 - 60	45
	Xtra-Guard 1	PVC	PVC	300	5320	4 - 37	47
	Xtra-Guard 1	PVC	PVC	600	5514	4 - 19	48
	Xtra-Guard 2	PVC	PUR	300	25152	2 - 50	64
	Xtra-Guard 3	PVC	PE	300	35152	2 - 15	76
	Xtra-Guard 4	TPE	TPE	300	45152	2 - 25	86
	Xtra-Guard 5	FEP	FEP	300	55152	2 - 12	99
Unshielded/Foil	Audio/Video	PVC	PVC	300	M4452	4	171

Cable Finder Guide

Can't find what you're looking for?
Alpha offers fast turnarounds on custom cables.
Visit our online Cable Design Center™ on
alphawire.com or call for more information.

20 AWG

Multipair							
Shielding	Type	Insulation	Jacket	Voltage	Part No. (Typ)	Pairs	Page
Unshielded	Audio/Video	PVC	PVC	300	M13063	3 - 15	151
	C&C	PVC	PVC	300	1317C	2 - 19	340
	Instrumentation	PVC	PVC	300	M9500010	1	203
	Security/Data	PVC	PVC	300	M2222	2 - 6	176
	Xtra-Guard 1	PVC	PVC	300	5282C	2 - 12	51
Foil, Overall	C&C	SR-PVC	PVC	300	6416	2	341
	C&C, Plenum	PVC	PVC	300/150	57632	2 - 6	362
	Computer	PVC	PVC	300	M4785	2 - 19	230
	Instrumentation	PVC	PVC	300	M9520010	1	204
	Instrumentation	PVC/Nylon	PVC	600	5616B2001	1	205
	Security/Data	PVC	PVC	300	M213202	2 - 6	178
	Xtra-Guard 1	PVC	PVC	300	5452C	2 - 19	53
	Xtra-Guard 2	PVC	PUR	300	25452	2 - 15	68
	Xtra-Guard 3	PVC	PE	300	35452	2 - 3	77
	Xtra-Guard 4	TPE	TPE	300	45451	1 - 27	91
Xtra-Guard 5	FEP	FEP	300	55451	1 - 12	102	
Foil, Ind. Pairs	Audio/Video	PP	HDPE	350	M39051	3 - 6	149
	Audio/Video	SR-PVC	PVC	300	M13142	2	154
	Audio/Video	PE	PVC	300	M13143	3 - 15	155
	Audio/Video	PP	PVC	300	M14604	4	156
	C&C	PP	PVC	300	6032C	3 - 12	357
	C&C, Direct Burial	PP	PE	350	6314	3 - 6	359
	Plenum	PVC	PVC	300	M243142	2 - 4	184
Security/Data	PVC	PVC	300	M213142	2 - 6	177	
Foil, Overall and Ind. Pairs	Instrumentation	PVC/Nylon	PVC	300	M9740020	2 - 50	215
Foil + Braid	Computer	SR-PVC	PVC	300	M5670	5 - 27	232
	Xtra-Guard 1	PVC	PVC	300	5292C	2 - 19	55
Supra-Shield Foil + Braid	Xtra-Guard 1	PVC	PVC	300	5350C	4 - 27	56
	Xtra-Guard 2	PVC	PUR	300	25292	2 - 9	70
	Xtra-Guard 4	TPE	TPE	300	45291	1 - 15	93
	Xtra-Guard 5	FEP	FEP	300	55291	1 - 12	103
Triads							
Shielding	Type	Insulation	Jacket	Voltage	Part No. (Typ)	Triads	Page
Unshielded	Instrumentation	PVC	PVC	300	M9600010	1	209
Foil, Overall	Instrumentation	PVC	PVC	300	M9520010	1 - 12	210
	Instrumentation	PVC/Nylon	PVC	300	M9700020	2 - 50	214
Foil, Overall and Ind. Pairs	Instrumentation	PVC	PVC	300	5650B2004	4 - 12	211

20 AWG + 18 AWG

Multiconductor							
Shielding	Type	Insulation	Jacket	Voltage	Part No. (Typ)	Conductors	Page
Unshielded + Foil	Audio/Video	PVC	PVC	300	M13291	4	173

18 AWG

Multiconductor							
Shielding	Type	Insulation	Jacket	Voltage	Part No. (Typ)	Conductors	Page
Unshielded	Audio/Video	PVC	PVC	300	M13502	2 - 25	144
	Audio/Video	PVC	PVC	300	M33502	2 - 25	159
	C&C	PVC	PVC	300	1897C	2 - 25	309
	C&C	IRR PVC	PVC	300	6652	2 - 4	312
	Computer	PVC	PVC	300	881802	2 - 15	216

Cable Finder Guide

Can't find what you're looking for?
Alpha offers fast turnarounds on custom cables.
Visit our online Cable Design Center™ on
alphawire.com or call for more information.

18 AWG

Multiconductor							
Shielding	Type	Insulation	Jacket	Voltage	Part No. (Typ)	Conductors	Page
Unshielded	Control	PVC/Nylon	PVC	600	M3800	2 - 37	191
	Control	PVC/Nylon	PVC	600	M39056	2	194
	Control	PVC	PVC	300	M39075	2 - 3	199
	AWIS Series F Continuous Flex	PVC/Nylon	TPE	600	F18003	3 - 65	127
	AWIS Series M Control	PVC/Nylon	PVC	600	M18103	3 - 65	129
	AWIS Series P Stationary Control	PVC/Nylon	TPE	600	MP181003	3 - 65	131
	AWIS Series XM Flexible Control	PVC/Nylon	PVC	600/1000	XM1803R	3 - 65	136
	Security/Data	PVC	PVC	300	M213502	2 - 4	174
	Solar	PVC/Nylon	PVC	1000	SPM1803	3 - 9	295
	Xtra-Guard Continuous Flex, Control	PVC	PVC	600	85803	3 - 34	111
	Xtra-Guard Continuous Flex, Control	PVC	PVC	600	85803CY	3 - 25	113
	Xtra-Guard Standard Flex	PVC	PVC	600	658002	2 - 50	106
	Xtra-Guard Torsional Flex	TPE	PUR	600	87303	3 - 7	119
	Xtra-Guard 1	PVC	PVC	300	5062C	2 - 60	34
	Xtra-Guard 1	PVC	PVC	600	5422	2 - 25	36
	Xtra-Guard 2	PVC	PUR	300	25061	2 - 25	59
	Xtra-Guard 2	PVC	PUR	600	25422	2 - 12	60
	Xtra-Guard 3	PVC	PE	300	35062	2 - 15	72
	Xtra-Guard 4	TPE	TPE	300	45062	2 - 25	81
	Xtra-Guard 4	TPE	TPE	600	45422	2 - 9	82
Xtra-Guard 5	FEP	FEP	300	55062	2 - 12	96	
Foil, Overall	Audio/Video	PE	PVC	300	M3242	2 - 4	152
	Audio/Video	PE	PVC	300	M13242	2 - 3	167
	Audio/Video	SR-PVC	PVC	300	M13244	4	167
	C&C	PE	PVC	300	2421C	2 - 4	314
	C&C, Plenum	PVC	PVC	300	58431	2 - 6	364
	Computer	PVC	PVC	300	M4690	2 - 40	220
	Control	PVC/Nylon	PVC	600	M33800	2 - 19	195
	Control	PVC/Nylon	PVC	600	M39109	2	197
	Control	PVC	PVC	300	M39117	2 - 3	202
	Plenum	PVC	PVC	300	M244825	2 - 4	180
	Plenum	FEP	PVDF	300	M413242	2	181
	Plenum	FEP	FEP	300	M64825	2 - 8	183
	Security/Data	PVC	PVC	300	M113242	2 - 4	175
	Xtra-Guard 1	PVC	PVC	300	5382C	2 - 60	40
	Xtra-Guard 1	PVC	PVC	600	5430	2 - 25	42
	Xtra-Guard 2	PVC	PUR	300	25382	2 - 50	62
	Xtra-Guard 2	PVC	PUR	600	25430	2 - 19	63
	Xtra-Guard 3	PVC	PE	300	35382	2 - 25	74
	Xtra-Guard 3	PVC	PE	600	35430	2 - 12	75
	Xtra-Guard 4	TPE	TPE	300	45382	2 - 30	84
Xtra-Guard 4	TPE	TPE	600	45430	2 - 12	85	
Xtra-Guard 5	FEP	FEP	300	55382	2 - 12	98	
Braid	AWIS Series XM Flexible Control	PVC/Nylon	PVC	600/1000	XM1803RCY	3 - 49	138
	Audio/Video	PE	PVC	300	M1142	2 - 6	147
	Audio/Video	PVC	PVC	300	M3212	2 - 4	164
	C&C	PVC/Nylon	PVC	600	3240	1 - 4	322
	C&C	PVC	PVC	300	1745	1 - 4	323
	C&C	IRR PVC	PVC	600	7671	2 - 4	325
	C&C	Rubber	Polychloroprene	600	1450	2 - 6	330
	C&C	TFE	Fiberglass	600	2819	1 - 5	333

Cable Finder Guide

Can't find what you're looking for?
Alpha offers fast turnarounds on custom cables.
Visit our online Cable Design Center™ on
alphawire.com or call for more information.

18 AWG

Multiconductor							
Shielding	Type	Insulation	Jacket	Voltage	Part No. (Typ)	Conductors	Page
Braid	C&C	PTFE	PTFE	600	2829/2	2 - 4	335
	Control	PVC	PVC	600	M1461	1 - 3	189
	Control	PVC	PVC	1000	M1704	4 - 16	190, 326
	High Temperature	PTFE	PTFE	600	18RC2S06	2 - 4	256
	High Temperature	ETFE	ETFE	600	275001801	1 - 2	257
	High Temperature	PTFE	PTFE	600	M1241	1 - 4	259
	High Temperature	PTFE	FEP	600	71801	1 - 2	260
	Solar	PVC/Nylon	PVC	600	SPM1803CY	3 - 9	294
	Xtra-Guard Standard Flex	PVC	PVC	600	65803CY	3 - 25	109
	Foil + Braid	Computer	PVC	PVC	300	M5390	2 - 30
Industrial Series SF Servo Power		PVC	TPE	600	SF61118CY	4	133
Spiral	C&C	PVC	PVC	300	2258	1 - 4	319
	Xtra-Guard Torsional Flex	TPE	PUR	600	87303CY	3 - 7	121
	Audio/Video	PVC	PVC	300	M3281	1 - 4	162, 163
Supra-Shield Foil + Braid	Xtra-Guard 1	PVC	PVC	300	5162C	2 - 40	46
	Xtra-Guard 1	PVC	PVC	600	5522	2 - 19	48
	Xtra-Guard 2	PVC	PUR	300	25162	2 - 40	65
	Xtra-Guard 2	PVC	PUR	600	25522	2 - 9	66
	Xtra-Guard 3	PVC	PE	300	35162	2 - 15	76
	Xtra-Guard 4	TPE	TPE	300	45162	2 - 30	87
	Xtra-Guard 4	TPE	TPE	600	45522	2 - 12	88
	Xtra-Guard 5	FEP	FEP	300	55162	2 - 12	100
Multipair							
Shielding	Type	Insulation	Jacket	Voltage	Part No. (Typ)	Pairs	Page
Unshielded	Audio/Video	PVC	PVC	300	M13081	1 - 19	133
	C&C	PVC	PVC	300	1131C	1 - 19	340
	Instrumentation	PVC	PVC	300	M9508010	1	203
	Instrumentation	PVC/Nylon	PVC	600	5606B1801	1	208
	Security/Data	PVC	PVC	300	M2215	2 - 4	176
	Xtra-Guard 1	PVC	PVC	300	5032C	2 - 12	51
	Xtra-Guard 4	TPE	TPE	300	45031	1 - 2	89
Foil, Overall	C&C	PVC	PVC	150	2241C	1 - 19	343
	C&C	PVC	PVC	300	6427	2 - 15	344
	Computer	PVC	PVC	300	4799	2 - 19	230
	Control	PVC	PVC	300	M39140	2 - 15	201
	Fieldbus, Type A	PO	PVC	300	6459	1	299
	Instrumentation	PVC	PVC	300	M39140	2 - 15	183
	Instrumentation	PVC/Nylon	PVC	600	M8528010	1 - 50	205
	Instrumentation	PVC/Nylon	PVC	600	M9528010	1	204
	Security/Data	PVC	PVC	300	M213182	2 - 4	178
	Xtra-Guard 1	PVC	PVC	300	5373C	3 - 6	53
	Xtra-Guard 2	PVC	PUR	300	25372	2 - 12	68
	Xtra-Guard 3	PVC	PE	300	35372	2 - 6	77
	Xtra-Guard 4	TPE	TPE	300	45371	1 - 19	91
	Xtra-Guard 5	FEP	FEP	300	55371	1 - 9	102
	Foil, Ind. Pairs	Audio/Video	PE	PVC	300	M13173	3 - 15
C&C		PVC	PVC	300	6062C	2 - 15	355
C&C		PP	PVC	300	6023C	3 - 9	356
C&C		PVC	PVC	300	6442	2 - 15	357
Control		PVC	PVC	300	M39157	2 - 15	200
DeviceNet, Thick and Thin		PVC/HDPE	PVC	300	6451	2	298

Cable Finder Guide

Can't find what you're looking for?
Alpha offers fast turnarounds on custom cables.
Visit our online Cable Design Center™ on
alphawire.com or call for more information.

Multipair							
Shielding	Type	Insulation	Jacket	Voltage	Part No. (Typ)	Pairs	Page
Foil, Ind. Pairs	Plenum	PVC	PVC	300	M243172	2 - 3	184
	Security/Data	PVC	PVC	300	M213172	2 - 6	177
Foil, Overall and Ind. Pairs	Instrumentation	PVC/Nylon	PVC	600	M8748020	2 - 50	207
	Instrumentation	PVC/Nylon	PVC	300	M9748020	2 - 50	215
	C&C, Mid Cap., Plenum	FEP	PVDF	150	58632	2 - 3	367
Foil + Braid	Industrial Twinax	PO	PVC	600	6450	1	303
	Xtra-Guard 1	PVC	PVC	300	5132C	2 - 27	55
Supra-Shield Foil + Braid	Xtra-Guard 2	PVC	PUR	300	25132	2 - 12	70
	Xtra-Guard 4	TPE	TPE	300	45131	1 - 15	93
	Xtra-Guard 5	FEP	FEP	300	55131	1 - 9	103

Triads							
Shielding	Type	Insulation	Jacket	Voltage	Part No. (Typ)	Triads	Page
Unshielded	Instrumentation	PVC	PVC	300	M9608010	1	209
	Instrumentation	PVC	PVC	300	M9628010	1	210
Foil, Overall	Instrumentation	PVC/Nylon	PVC	600	M8628010	1 - 24	212
	Instrumentation	PVC	PVC	300	M9708020	2 - 50	214
Foil, Overall and Ind. Pairs	Instrumentation	PVC/Nylon	PVC	600	M8848020	2 - 24	213

16 AWG

Multiconductor							
Shielding	Type	Insulation	Jacket	Voltage	Part No. (Typ)	Conductors	Page
Unshielded	Audio/Video	PVC	PVC	300	M13572	2 - 4	144
	Audio/Video	PVC	PVC	300	M3704	4 - 15	145
	Audio/Video	PVC	PVC	300	M33572	2 - 8	160
	C&C	PVC	PVC	300	1899C	2 - 4	309
	C&C	PVC	PVC	600	1064	4 - 25	311
	Computer	PVC	PVC	300	881602	2 - 10	217
	Control	PVC/Nylon	PVC	600	M3826	2 - 37	191
	Control	PVC/Nylon	PVC	600	M39057	2	194
	Control	PVC	PVC	300	M39077	2 - 3	199
	AWIS Series F Continuous Flex	PVC/Nylon	TPE	600	F16003	3 - 65	127
	AWIS Series M Control	PVC/Nylon	PVC	600	M161003	3 - 65	129
	AWIS Series P Stationary Control	PVC/Nylon	TPE	600	MP161003	3 - 65	131
	AWIS Series XM Flexible Control	PVC/Nylon	PVC	600/1000	XM1603R	3 - 49	136
	Security/Data	PVC	PVC	300	M213572	2 - 4	174
	Solar	PVC/Nylon	PVC	1000	SPM1603	3 - 9	295
	Xtra-Guard Continuous Flex, Control	PVC	PVC	600	85603	3 - 50	111
	Xtra-Guard Continuous Flex, Control	PVC	PVC	600	85603CY	3 - 34	113
	Xtra-Guard Standard Flex	PVC	PVC	600	65602	2 - 50	106
	Xtra-Guard Torsional Flex	TPE	PUR	600	87403	3 - 7	120
	Xtra-Guard 1	PVC	PVC	300	5072C	2 - 50	34
Xtra-Guard 1	PVC	PVC	600	5434	4 - 25	37	
Xtra-Guard 2	PVC	PUR	300	25072	2 - 25	59	
Xtra-Guard 2	PVC	PUR	600	25432	2 - 19	60	
Xtra-Guard 3	PVC	PE	300	35072	2 - 15	72	
Xtra-Guard 4	TPE	TPE	300	45072	2 - 25	81	
Xtra-Guard 4	TPE	TPE	600	45432	2 - 9	82	
Xtra-Guard 6	FEP	FEP	300	55072	2 - 12	96	
Audio/Video	PVC	PVC	300	M13572	2 - 4	144	

Cable Finder Guide

Can't find what you're looking for?
Alpha offers fast turnarounds on custom cables.
Visit our online Cable Design Center™ on
alphawire.com or call for more information.

16 AWG

Multiconductor								
Shielding	Type	Insulation	Jacket	Voltage	Part No. (Typ)	Conductors	Page	
Foil, Overall	Audio/Video	PE	PVC	300	M3247	2 - 3	153	
	Audio/Video	PE	PVC	300	M13247	2 - 3	168	
	C&C	PE	PVC	300	2432C	2 - 3	314	
	C&C, Plenum	PVC	PVC	300	58142	2 - 4	364	
	Computer	PVC	PVC	300	M4720	2 - 30	221	
	Control	PVC/Nylon	PVC	600	M33826	2 - 19	195	
	Control	PVC/Nylon	PVC	600	M39110	2	197	
	Control	PVC/Nylon	PVC	600	7616/6	6	198	
	Control	PVC	PVC	300	M39119	2 - 3	202	
	Plenum	PVC	PVC	300	M244834	2 - 4	180	
	Plenum	FEP	FEP	300	M64834	2 - 4	183	
	Security/Data	PVC	PVC	300	M113247	2 - 3	175	
	Xtra-Guard 1	PVC	PVC	300	5362C	2 - 40	40	
	Xtra-Guard 1	PVC	PVC	600	5440	2 - 15	43	
	Xtra-Guard 2	PVC	PUR	300	25362	2 - 50	62	
	Xtra-Guard 2	PVC	PUR	600	25440	2 - 15	63	
	Xtra-Guard 3	PVC	PE	300	35362	2 - 25	74	
	Xtra-Guard 3	PVC	PE	600	35440	2 - 12	75	
	Xtra-Guard 4	TPE	TPE	300	45362	2 - 25	84	
	Xtra-Guard 4	TPE	TPE	600	45440	2 - 12	85	
Xtra-Guard 5	FEP	FEP	300	55362	2 - 12	98		
	AWIS Series XM Flexible Control	PVC/Nylon	PVC	600/1000	XM1603RCY	3 - 49	138	
Braid	Audio/Video	PE	PVC	300	M1162	2 - 4	147	
	Audio/Video	PVC	PVC	300	M3216	2 - 3	164	
	C&C	PVC/Nylon	PVC	600	3245	1 - 4	322	
	C&C	PVC	PVC	300	1748C	2 - 3	323	
	C&C	Rubber	Polychloroprene	600	1450/16	2 - 3	330	
	C&C	TFE	Fiberglass	600	2820	1 - 4	333	
	C&C	PTFE	PTFE	600	2826	1 - 4	335	
	Control	PVC	PVC	600	M1471	1 - 4	189	
	Control	PVC	PVC	1000	M1764	4 - 27	190, 326	
	High Temperature	PTFE	PTFE	600	M1251	1 - 4	259	
	High Temperature	PTFE	FEP	600	71602	2	260	
	Solar	PVC/Nylon	PVC	600	SPM1603CY	3 - 9	294	
	Xtra-Guard Standard Flex	PVC	PVC	600	65603CY	3 - 25	109	
	Foil + Braid	Computer	PVC	PVC	300	M5420	2 - 25	229
		Flexible Motor Supply	PVC/Nylon	PVC	600	5660	4	304
AWIS Series SF Servo Composite		PVC	TPE	600	SF61220CY	4 + 2 pr	133	
AWIS Series SF Servo Power		PVC	TPE	600	SF61116CY	4	133	
AWIS Series V VFD		XLPE	PVC	600/1000	V16316/V16016	3, 4, 4 + 1 pr	134, 135	
Spiral	C&C	PVC	PVC	300	2260	2 - 3	319	
	Xtra-Guard Torsional Flex	TPE	PUR	600	87403CY	3 - 7	122	
Supra-Shield Foil + Braid	Audio/Video	PVC	PVC	300	M3287	2 - 3	163	
	Xtra-Guard 1	PVC	PVC	300	5172C	2 - 25	46	
	Xtra-Guard 1	PVC	PVC	600	5532	2 - 19	49	
	Xtra-Guard 2	PVC	PUR	300	25172	2 - 40	65	
	Xtra-Guard 2	PVC	PUR	600	25532	2 - 19	66	

Cable Finder Guide

Can't find what you're looking for?
Alpha offers fast turnarounds on custom cables.
Visit our online Cable Design Center™ on
alphawire.com or call for more information.

16 AWG

Multiconductor							
Shielding	Type	Insulation	Jacket	Voltage	Part No. (Typ)	Conductors	Page
Supra-Shield Foil + Braid	Xtra-Guard 2	PVC	PUR	600	25542	2 - 12	66
	Xtra-Guard 3	PVC	PE	300	35172	2 - 15	76
	Xtra-Guard 4	TPE	TPE	300	45172	2 - 25	87
	Xtra-Guard 4	TPE	TPE	600	45532	2 - 12	88
	Xtra-Guard 5	FEP	FEP	300	55172	2 - 12	100
Multipair							
Shielding	Type	Insulation	Jacket	Voltage	Part No. (Typ)	Pairs	Page
Unshielded	Instrumentation	PVC	PVC	300	M9506010	1	202
	Instrumentation	PVC/Nylon	PVC	600	5606B1601	1	208
Foil, Overall	C&C	PE	PVC	600	2471	1	348
	Computer	PVC	PVC	300	M4799	2 - 6	230
	Instrumentation	PVC	PVC	300	M9526010	1	204
	Instrumentation	PVC/Nylon	PVC	600	M8526010	1 - 50	205
Foil, Ind. Pairs	C&C, Mid Cap., Plenum	FEP	PVDF	150	58642	2 - 3	367
Foil, Overall and Ind. Pairs	Instrumentation	PVC/Nylon	PVC	600	M8746020	2 - 50	207
	Instrumentation	PVC/Nylon	PVC	300	M9746020	2 - 50	215
Triads							
Shielding	Type	Insulation	Jacket	Voltage	Part No. (Typ)	Triads	Page
Unshielded	Instrumentation	PVC	PVC	300	M9606010	1	209
	Instrumentation	PVC	PVC	300	M9626010	1	210
Foil, Overall	Instrumentation	PVC/Nylon	PVC	600	M8626010	1 - 24	212
	Instrumentation	PVC/Nylon	PVC	300	M9706020	2 - 50	214
Foil, Overall and Ind. Pairs	Instrumentation	PVC/Nylon	PVC	600	M8846020	2 - 24	213

14 AWG

Multiconductor							
Shielding	Type	Insulation	Jacket	Voltage	Part No. (Typ)	Conductors	Page
Unshielded	Audio/Video	PVC	PVC	300	M13582	2 - 4	144
	Audio/Video	PVC	PVC	300	M33582	2 - 3	160
	C&C	PVC	PVC	300	1891C	2 - 3	310
	C&C	PVC	PVC	600	1274	4 - 12	311
	Computer	PVC	PVC	300	881403	3 - 5	217
	Control	PVC/Nylon	PVC	600	M3845	2 - 37	191
	Control	PVC/Nylon	PVC	600	M39058	2	194
	Control	PVC	PVC	300	M39079	2 - 3	199
	AWIS Series F Continuous Flex	PVC/Nylon	TPE	600	F14004	4 - 12	128
	AWIS Series M Control	PVC/Nylon	PVC	600	M141004	4 - 25	130
	AWIS Series P Stationary Control	PVC/Nylon	TPE	600	MP141004	4 - 25	132
	AWIS Series XM Flexible Control	PVC/Nylon	PVC	600/1000	XM1403R	3 - 12	136
	Solar	PVC/Nylon	PVC	1000	SPM1403	3 - 9	295
	Xtra-Guard Continuous Flex, Control	PVC	PVC	600	85403	4 - 7	111
	Xtra-Guard Continuous Flex, Control	PVC	PVC	600	85404CY	4 - 7	113
	Xtra-Guard Standard Flex	PVC	PVC	600	65402	2 - 50	107
	Xtra-Guard Torsional Flex	TPE	PUR	600	87503	3 - 7	120
	Xtra-Guard 1	PVC	PVC	600	5442	2 - 25	37
	Xtra-Guard 2	PVC	PUR	600	25442	2 - 12	60
	Xtra-Guard 4	TPE	TPE	600	45442	2 - 7	82

Cable Finder Guide

Can't find what you're looking for?
Alpha offers fast turnarounds on custom cables.
Visit our online Cable Design Center™ on
alphawire.com or call for more information.

14 AWG

Multiconductor							
Shielding	Type	Insulation	Jacket	Voltage	Part No. (Typ)	Conductors	Page
Foil, Overall	Audio/Video	PE	PVC	300	M3249	2	153
	Audio/Video	PE	PVC	300	M13249	2	168
	C&C	PE	PVC	300	2442C	2	315
	Control	PVC/Nylon	PVC	600	M33845	2 - 19	195
	Control	PVC/Nylon	PVC	600	M39111	2	197
	Control	PVC/Nylon	PVC	600	7614/6	6	198
	Control	PVC	PVC	300	M39121	2 - 3	202
	Xtra-Guard 1	PVC	PVC	600	5450	2 - 12	43
	Xtra-Guard 2	PVC	PUR	600	25450	2 - 15	63
	Xtra-Guard 3	PVC	PE	600	35450	2 - 12	75
	Xtra-Guard 4	TPE	TPE	600	45450	2 - 15	85
	Braid	AWIS Series XM Flexible Control	PVC/Nylon	PVC	600/1000	XM1403RCY	3 - 12
Audio/Video		PVC	PVC	300	M33218	2 - 3	165
C&C		PVC	PVC	300	1750	2 - 3	324
C&C		TFE	Fiberglass	600	2804/2	1 - 2	333
Solar		PVC/Nylon	PVC	600	SPM1403CY	3 - 9	294
Foil + Braid	Xtra-Guard Standard Flex	PVC	PVC	600	65403CY	3 - 18	109
	Flexible Motor Supply	PVC/Nylon	PVC	600	5661	4	304
	AWIS Series SF Servo Composite	PVC	TPE	600	SF61221CY	4 + 2 pr	133
	AWIS Series SF Servo Power	PVC	TPE	600	SF61114CY	4	133
Spiral	AWIS Series V VFD	XLPE	PVC	600/1000	V16314/V16014	3, 4, 4 + 1 pr	134, 135
	Xtra-Guard Torsional Flex	TPE	PUR	600	87503CY	3 - 7	122
	Audio/Video	PVC	PVC	450	M3289	2 - 3	163
Supra-Shield Foil + Braid	Xtra-Guard 1	PVC	PVC	600	5542	2 - 19	49
	Xtra-Guard 4	TPE	TPE	600	45542	2 - 9	88
Multipair							
Shielding	Type	Insulation	Jacket	Voltage	Part No. (Typ)	Pairs	Page
Foil, Overall	C&C	PE	PVC	600	2472	1	348
	Instrumentation	PVC	PVC	300	M9524010	1	204
	Instrumentation	PVC/Nylon	PVC	600	M8524010	1 - 50	206
Foil, Overall and Ind. Pairs	Instrumentation	PVC/Nylon	PVC	600	M8744020	2 - 50	207
Triads							
Shielding	Type	Insulation	Jacket	Voltage	Part No. (Typ)	Triads	Page
Foil, Overall	Instrumentation	PVC	PVC	300	M9624010	1	210
	Instrumentation	PVC/Nylon	PVC	600	M8624010	1 - 24	212
Foil, Overall and Ind. Pairs	Instrumentation	PVC/Nylon	PVC	600	M8844020	2 - 24	213

12 AWG

Multiconductor							
Shielding	Type	Insulation	Jacket	Voltage	Part No. (Typ)	Conductors	Page
Unshielded	Audio/Video	PVC	PVC	300	M13590	2	144
	Audio/Video	PVC	PVC	300	M33590	2 - 3	160
	C&C	PVC	PVC	300	1892C	2 - 3	310
	Computer	PVC	PVC	300	881202	2 - 3	217
	Control	PVC/Nylon	PVC	600	M3865	2 - 37	192

Cable Finder Guide

Can't find what you're looking for?
Alpha offers fast turnarounds on custom cables.
Visit our online Cable Design Center™ on
alphawire.com or call for more information.

12 AWG

Multiconductor								
Shielding	Type	Insulation	Jacket	Voltage	Part No. (Typ)	Conductors	Page	
Unshielded	Control	PVC/Nylon	PVC	600	M39059	2	194	
	Control	PVC	PVC	300	M39081	2	199	
	AWIS Series F Continuous Flex	PVC/Nylon	TPE	600	F12004	4 - 7	128	
	AWIS Series M Control	PVC/Nylon	PVC	600	M121004	4 - 7	130	
	AWIS Series P Stationary Control	PVC/Nylon	TPE	600	MP121004	4 - 7	132	
	AWIS Series XM Flexible Control	PVC/Nylon	PVC	600/1000	XM1203R	3 - 7	137	
	Solar	PVC/Nylon	PVC	1000	SPM1203	3 - 9	295	
	Xtra-Guard Continuous Flex, Control	PVC	PVC	600	85204	4 - 7	112	
	Xtra-Guard Continuous Flex, Control	PVC	PVC	600	85204CY	4 - 7	114	
	Xtra-Guard Standard Flex	PVC	PVC	600	65203	3 - 7	107	
	Xtra-Guard Torsional Flex	TPE	PUR	600	87603	3 - 7	120	
	Foil, Overall	Audio/Video	PE	PVC	300	M3250	2	153
		Audio/Video	PE	PVC	300	M13250	2	168
C&C		PE	PVC	300	2444C	2	315	
Control		PVC/Nylon	PVC	600	M33865	2 - 19	196	
Control		PVC/Nylon	PVC	600	M39112	2	197	
Control		PVC	PVC	300	M39123	2	202	
Braid	AWIS Series XM Flexible Control	PVC/Nylon	PVC	600/1000	XM1203RCY	3 - 7	139	
	Audio/Video	PVC	PVC	300	M33220	2 - 3	165	
	C&C	PVC	PVC	300	1760	2 - 3	324	
	C&C	TFE	Fiberglass	600	2803/2	2	333	
	Solar	PVC/Nylon	PVC	600	SPM1203CY	3 - 9	294	
	Xtra-Guard Standard Flex	PVC	PVC	600	65203CY	3 - 5	110	
Foil + Braid	Flexible Motor Supply	PVC/Nylon	PVC	600	5662	4	304	
	AWIS Series SF Servo Composite	PVC	TPE	600	SF61222CY	4 + 2 pr	133	
	AWIS Series SF Servo Power	PVC	TPE	600	SF61112CY	4	133	
	AWIS Series V VFD	XLPE	PVC	600/1000	V16312/ V16014	3, 4, 4 + 1 pr	134, 135	
Spiral	Xtra-Guard Torsional Flex	TPE	PUR	600	87603CY	3 - 7	122	
Multipair								
Shielding	Type	Insulation	Jacket	Voltage	Part No. (Typ)	Pairs	Page	
Foil, Overall	C&C	PE	PVC	600	2473	1	348	
	Instrumentation	PVC	PVC	300	5610B1201	1	204	
	Instrumentation	PVC/Nylon	PVC	600	5616B1201	1	206	

10 AWG

Multiconductor							
Shielding	Type	Insulation	Jacket	Voltage	Part No. (Typ)	Conductors	Page
Unshielded	Control	PVC/Nylon	PVC	600	M3902	2 - 15	193
	AWIS Series F Continuous Flex	PVC/Nylon	TPE	600	F10004	4 - 7	128
	AWIS Series M Control	PVC/Nylon	PVC	600	M101004	4 - 7	130
	AWIS Series P Stationary Control	PVC/Nylon	TPE	600	MP101004	4 - 7	132
	AWIS Series XM Flexible Control	PVC/Nylon	PVC	600/1000	XM1003R	3 - 7	137
	Xtra-Guard Continuous Flex, Control	PVC	PVC	600	85104	4 - 7	112
	Xtra-Guard Continuous Flex, Control	PVC	PVC	600	85104CY	4 - 7	114

Cable Finder Guide

Can't find what you're looking for?
Alpha offers fast turnarounds on custom cables.
Visit our online Cable Design Center™ on
alphawire.com or call for more information.

10 AWG

Multiconductor							
Shielding	Type	Insulation	Jacket	Voltage	Part No. (Typ)	Conductors	Page
Unshielded	Xtra-Guard Standard Flex	PVC	PVC	600	65103	3 - 5	107
	Xtra-Guard Torsional Flex	TPE	PUR	600	87703	3 - 7	120
Foil, Overall	Control	PVC/Nylon	PVC	600	M33902	2 - 12	196
Braid	AWIS Series XM Flexible Control	PVC/Nylon	PVC	600/1000	XM1003RCY	3 - 7	139
	Xtra-Guard Standard Flex	PVC	PVC	600	65103CY	3 - 7	110
Foil + Braid	Flexible Motor Supply	PVC/Nylon	PVC	600	5663	4	304
	AWIS Series SF Servo Composite	PVC	TPE	600	SF61223CY	4 + 2 pr	133
	AWIS Series SF Servo Power	PVC	TPE	600	SF61110CY	4	133
	AWIS Series V VFD	XLPE	PVC	600/1000	V16310/V16012	3, 4, 4 + 1 pr	134, 135
Spiral	Xtra-Guard Torsional Flex	TPE	PUR	600	87703CY	3 - 7	122

8 AWG

Multiconductor							
Shielding	Type	Insulation	Jacket	Voltage	Part No. (Typ)	Conductors	Page
Unshielded	AWIS Series F Continuous Flex	PVC/Nylon	TPE	600	F08004	4	128
	AWIS Series M Control	PVC/Nylon	PVC	600	M081004	4-5	130
	AWIS Series P Stationary Control	PVC/Nylon	TPE	600	MP081004	4 - 7	132
	AWIS Series XM Flexible Control	PVC/Nylon	PVC	600/1000	XM0803R	3 - 4	137
	Xtra-Guard Continuous Flex, Control	PVC	PVC	600	85904	4	112
	Xtra-Guard Continuous Flex, Control	PVC	PVC	600	85904CY	4	114
	Xtra-Guard Standard Flex	PVC	PVC	600	65904	4 - 5	107
Braid	AWIS Series XM Flexible Control	PVC/Nylon	PVC	600/1000	XM0803RCY	3 - 4	139
	Xtra-Guard Standard Flex	PVC	PVC	600	65904CY	4	110
	Flexible Motor Supply	PVC/Nylon	PVC	600	5664	4	304
Foil + Braid	AWIS Series SF Servo Composite	PVC	TPE	600	SF61224CY	4 + 2 pr	133
	AWIS Series SF Servo Power	PVC	TPE	600	SF61108CY	4	133
	AWIS Series V VFD	XLPE	PVC	600/1000	V16308/V16008	3, 4, 4 + 1 pr	134, 135

6 AWG

Multiconductor							
Shielding	Type	Insulation	Jacket	Voltage	Part No. (Typ)	Conductors	Page
Unshielded	Xtra-Guard Continuous Flex, Control	PVC	PVC	600	85704	4	112
	Xtra-Guard Continuous Flex, Control	PVC	PVC	600	85704CY	4	114
	Xtra-Guard Standard Flex	PVC	PVC	600	65704	4 - 5	108
Braid	Xtra-Guard Standard Flex	PVC	PVC	600	65704CY	4	110
Foil + Braid	Flexible Motor Supply	PVC/Nylon	PVC	600	5665	4	304
	AWIS Series V VFD	XLPE	PVC	600/1000	V16306/V16006	3, 4, 4 + 1 pr	134, 135

Cable Finder Guide

Can't find what you're looking for?
Alpha offers fast turnarounds on custom cables.
Visit our online Cable Design Center™ on
alphawire.com or call for more information.

4 AWG

Multiconductor							
Shielding	Type	Insulation	Jacket	Voltage	Part No. (Typ)	Conductors	Page
Unshielded	Xtra-Guard Continuous Flex, Control	PVC	PVC	600	85504	4	112
	Xtra-Guard Continuous Flex, Control	PVC	PVC	600	85504CY	4	114
	Xtra-Guard Standard Flex	PVC	PVC	600	65504	4 - 5	108
Braid	Xtra-Guard Standard Flex	PVC	PVC	600	65504CY	4	110
Foil + Braid	AWIS Series V VFD	XLPE	PVC	600/1000	V16304/ V16004	3, 4, 4 + 1 pr	134, 135

2 AWG

Multiconductor							
Shielding	Type	Insulation	Jacket	Voltage	Part No. (Typ)	Conductors	Page
Unshielded	Xtra-Guard Continuous Flex, Control	PVC	PVC	600	85304	4	112
	Xtra-Guard Continuous Flex, Control	PVC	PVC	600	85304CY	4	114
	Xtra-Guard Standard Flex	PVC	PVC	600	65304	4 - 5	108
Braid	Xtra-Guard Standard Flex	PVC	PVC	600	65304CY	4	110
Foil + Braid or Tape	AWIS Series V VFD	XLPE	PVC	600/1000	V16302/ V16002	3, 4, 4 + 1 pr	134, 135

1 AWG

Multiconductor							
Shielding	Type	Insulation	Jacket	Voltage	Part No. (Typ)	Conductors	Page
Tape	AWIS Series V VFD	XLPE	PVC	600/1000	V16001	3	134, 135

1/0 AWG

Multiconductor							
Shielding	Type	Insulation	Jacket	Voltage	Part No. (Typ)	Conductors	Page
Tape	AWIS Series V VFD	XLPE	PVC	600/1000	V16000	3	134, 135

2/0 AWG

Multiconductor							
Shielding	Type	Insulation	Jacket	Voltage	Part No. (Typ)	Conductors	Page
Tape	AWIS Series V VFD	XLPE	PVC	600/1000	V16020	3	134, 135

3/0 AWG

Multiconductor							
Shielding	Type	Insulation	Jacket	Voltage	Part No. (Typ)	Conductors	Page
Tape	AWIS Series V VFD	XLPE	PVC	600/1000	V16030	3	134, 135

4/0 AWG

Multiconductor							
Shielding	Type	Insulation	Jacket	Voltage	Part No. (Typ)	Conductors	Page
Tape	AWIS Series V VFD	XLPE	PVC	600/1000	V16040	3	134, 135

Industry Standards Cross-Reference

Specification	Page	Specification	Page	Specification	Page
A-A-52080 Type 1	516	CSA 5836 01	506-507, 512, 515	MIL-DTL-16878/6	398
A-A-52081	517	CSA AWM I A/B	396, 412-413, 414	MIL-DTL-22759/11	403
A-A-52084	518	CSA AWM I A/B FT1	381-383, 391, 394, 418, 429-431	MIL-DTL-22759/16	403
A-A-59163	504	CSA AWM I A/B FT2	397, 407	MIL-I-22129	498
A-A-59551	512	CSA AWM I/II A		MIL-I-3190/2 Class 130 Type B Cat b	500
A-A-59569	521-522	CSA AWM I/II A/B FT1	58-70, 80-93, 106-114, 294-295, 380	MIL-I-3190/3 Grade C1	499
A-A-59569A	519	CSA AWM I/II A/B FT4	36-37, 42-43, 48-49, 115-122, 127-139, 216-218, 222-226, 298, 304, 315	MIL-I-3190/6 Class 20 Type D Cat C	501
A-A-59602	495-496	CSA C22.2	261-269, 272-274, 278-280, 490	MIL-I-631	505-506
ABYC	429-430	CSA CL 1251 XLPE	393, 395, 396	MIL-I-631D	489, 495-496
AMS 3655	497	CSA CM	35, 143-144, 154-155, 170-173, 234-236, 299, 302	MIL-P-21922B	495-496
AMS DTL-23053/1 Class 1	464	CSA CM FT1	353, 362	MIL-S-47053	513
AMS DTL-23053/1 Class 2	464	CSA CMG	32-34, 50-55, 115-118, 156, 171-173	MIL-STD-202C	503
AMS DTL-23053/11 Class 1	461	CSA CMG FT1	302, 310	MIL-STD-202F Method 215J	475
AMS DTL-23053/12 Class 3	463	CSA CMG FT4	35, 38-41, 44-47, 56, 143-144, 150-151, 152-153, 158-169, 199-204, 209-211, 214-215, 219-221, 227-228, 229-233, 237, 297-298, 301, 303, 306-309, 313-314, 316-318, 323, 336-338, 341-345, 347, 350-351, 354-358, 360-361, 370	MIL-W-16878/14 (Type E)	259
AMS DTL-23053/13 Class 1	473	CSA CMH FT1	339, 346, 352	MIL-W-16878/4 (Type E)	258, 260
AMS DTL-23053/15 Class 2	474	CSA CMP	184, 186-187	MIL-W-76 Type HW	385
AMS DTL-23053/18 Class 1	471	CSA CMP FT6	95-103, 179-183, 185, 363-367	MIL-W-76 Type LW	384
AMS DTL-23053/2 Class 1	450	CSA CMR	174-178	MIL-W-76 Type MW	390, 422
AMS DTL-23053/4 Class 1	457	CSA FT2	272	MIL-W-76 Type MWP	388
AMS DTL-23053/4 Class 2	468	CSA REW XLPVC FT1	392	MIL-Y-1140	502
AMS DTL-23053/4 Class 3	458	CSA RW90	416	MSHA	134-135
AMS DTL-23053/5 Class 1	451-454, 459, 462, 477	CSA SEW-2	407-408	MSHA P-07-KA070017-MSHA	80-93
AMS DTL-23053/5 Class 2	451-453	CSA SEWF-2	407-408	MVSS 302	469
AMS DTL-23053/5 Class 3	454, 459	CSA TEW-105	382-383, 429-431	NAS 1745	479
AMS DTL-23053/6 Class 1	456	CSA TR-64 FT1	380, 422	NEC Class 1, Div 2	80-93
AMS DTL-23053/6 Class 2	456	C-Tick	270	NEMA Accepted	283-284
AMS DTL-23053/8	460	ENEC-11	270	NEMA HP3	258-259, 331-335, 398-402
ANSI C119:1	467	FAR25	507, 509, 511	NEMA TF-1	499
ANSI J-STD-004	479	ICEA Accepted	283-284	NEMA TF-1 Grade A	500-501
ANSI J-STD-006	479	IEC 60332-1	417	NEMA WC27500 Type RC	256
ASTM B33	421	IEC 60754-1	417	NEMA WC27500 Type TE	257
ASTM 1248-65T	495-496	IEC 60754-2	417	SAA	271
ASTM D 1000, Method 303	503	ISA MC 96.1	288-290	SAE AS22759/11	256, 403
ASTM D 3295-81a Type 1, Class B	497	JET 252	270	SAE AS22759/16	257, 403
ASTM D 3295-81a Type 1, Class C	498	MIL-DTL-16878/1	188-189, 320, 325, 384, 391, 394, 419	SAE J1127 Type SGT	429
ASTM D 350/372 Class C	502	MIL-DTL-16878/11	213	SAE J1128	431
ASTM D 4066	495-496	MIL-DTL-16878/17	188-189, 321-322, 388	SAE J1128 Type GPT	428, 430, 436, 438, 440
ASTM D922	489	MIL-DTL-16878/18	190	SAE J1128 Type GXL	398
CID A-A-59301	513	MIL-DTL-16878/2	190, 326, 386, 392, 420	SAE J1128 Type HDT	436
CID AA-59551 Type S	422	MIL-DTL-16878/4	331-335, 393, 399-400	SAE J378 Type GPT	428, 430, 440
Coast Guard	429-430	MIL-DTL-16878/5	401-402	SAE J378B	429, 436, 437
CSA 198	450-456, 458-459, 467-468, 475, 489			SJ	262-263, 265, 274

Industry Standards Cross-Reference

Specification	Page	Specification	Page	Specification	Page
SVO	272, 278-280	UL AWM 2463	144-145, 310	UL CL2P	363-367
SVT	262-267, 273	UL AWM 2464	32-34, 38-40, 44-46, 50-55, 143-144, 150-151, 154-155, 161, 165-169, 216-218, 220-226, 229-231, 237, 275-276, 318, 336, 338, 340-343, 350-351	UL CL2R	297
T-Mark	270	UL AWM 2490	370	UL CL3	203-204, 209-210, 214-215
TUV 2 PFG 1169	417	UL AWM 2493	154-155, 233, 357, 370	UL CM	36-37, 38-41, 44-47, 50-56, 115-118, 143-144, 146-149, 154-155, 166-168, 170-173, 233-236, 299, 302, 306-308, 313, 316-318, 323, 338-347, 351, 353, 355, 357-358, 360, 362, 370
Type W	283-284	UL AWM 2493	362	UL CMG	32-34, 143-144, 152-153, 156, 158-169, 171-172, 199-202, 219-221, 223-227, 229-232, 237, 301-303, 314, 357, 361
UL 1000 V Motor Supply	134-135	UL AWM 2501	36-37, 42-43, 48-49	UL CMP	95-103, 179-187, 363-367
UL 1441	469, 500-502	UL AWM 2509	143-144, 159-161	UL CMR	174-178, 297
UL 1696	490	UL AWM 2555	421	UL Direct Burial	127, 134-135, 191-198, 205-208, 212-213, 294-295
UL 224	450-460, 468, 470-471, 475, 489, 512	UL AWM 2576	143-144, 150-151, 159-161, 171-173, 308, 311, 317, 340, 343	UL ITC	199-204, 209-210, 214-215, 289-290, 299, 303
UL 4703 PV	416-417	UL AWM 2587	106-114, 375	UL MTW	36-37, 42-43, 48-49, 129-130, 136-139, 294-295, 304, 382-383
UL 486	467	UL AWM 2598	144	UL Oil Res. I	127-130, 136-139, 294-295, 429-436
UL 510	503	UL AWM 2651	371	UL Oil Res. I/II	125-126, 131-133
UL 62	263-269, 272-274, 278-289	UL AWM 2661	115-118	UL PLTC	80-81, 83-84, 86-87, 89-93, 127-128, 129-132, 199-204, 209-211, 214-215, 289-290, 301-303, 344, 358
UL AWM 1007	380, 422	UL AWM 2668	370	UL PLTC-ER	298-299
UL AWM 1015	382-383, 430	UL AWM 2678	374	UL RHW-2	134-135
UL AWM 1028	382-383, 431	UL AWM 2713	419	UL SF-2	407
UL AWM 1061	232, 381	UL AWM 2717	171-173	UL SFF-2	407
UL AWM 1108	162-163, 319, 323	UL AWM 2785	313	UL SIS	396-397
UL AWM 1180	401	UL AWM 2912	373	UL Standard 817	261-269
UL AWM 1213	400	UL AWM 2919	154-155, 228, 234, 236, 337, 339, 345-347, 353-356, 360	UL Sunlight Resistant	125-139, 191-215, 294-295, 297-303, 344, 416-417
UL AWM 1230	382-383, 430	UL AWM 2960	236, 352	UL TC	82, 85, 88, 191-198, 205-208, 212-213, 302-303
UL AWM 1231	382-383	UL AWM 3070	407	UL TC-ER	127-139, 294-295, 304
UL AWM 1232	382-383	UL AWM 3071	407	UL TFFN	127, 131, 387
UL AWM 1283	382-383	UL AWM 3074	407	UL TFN	387
UL AWM 1284	382-383	UL AWM 3075	407	UL THHN	128, 132, 387
UL AWM 1422	404	UL AWM 3101	408	UL THW	382-383
UL AWM 1423	404	UL AWM 3173	395-396	UL THWN	387
UL AWM 1429	391	UL AWM 3195	395	UL TW	382
UL AWM 1430	392	UL AWM 3196	395	UL UZKX2	495-496, 505-507, 512
UL AWM 1516	404	UL AWM 3212	406	UL UZKYZ	515
UL AWM 1523, 423	404	UL AWM 3213	406	UL WTTC	82, 85, 129-130, 133, 294-295, 304
UL AWM 1569	380	UL AWM 3214	406	UL XHHW-2	134-135
UL AWM 1581	380	UL AWM 3231	408		
UL AWM 20013	281	UL AWM 3239	409-410		
UL AWM 20201	301	UL AWM 3265	394		
UL AWM 20229	95-103	UL AWM 3271	393		
UL AWM 20234	119-122	UL AWM 3278	408		
UL AWM 20237	80-81, 83-84, 86-87, 89-93	UL AWM 4182	277		
UL AWM 20238	82, 85, 88	UL AWM 4194	277		
UL AWM 20253	166-168	UL AWM 4195	277		
UL AWM 20381	372	UL AWM 4196	277		
UL AWM 20668	58-59, 61-62, 64-65, 67-70	UL AWM 4197	277		
UL AWM 2092	146-149, 152-153, 166-168, 314	UL AWM 4198	277		
UL AWM 2093	146-149, 152-153, 166-168, 314	UL AWM 5107	412		
UL AWM 20932	371	UL AWM 5196	413-414		
UL AWM 2094	146-149, 152-153, 166-168, 171-173, 314	UL AWM 5251	414		
UL AWM 2095	158, 162-165, 319, 323	UL BC-5W2	430-436, 438, 439		
UL AWM 20952	60, 63, 66	UL CL2	153, 159-160, 166-168, 216-218, 222, 298, 310, 315, 336-337, 350, 352, 354, 356, 371-373		
UL AWM 2106	348				
UL AWM 2343	35, 41, 47, 56, 219, 227, 232, 236				

The Products You Can Trust

Alpha Wire offers a complete portfolio of exceptionally reliable wire, cable, tubing, and accessories.

Count on us for the great service and quality we're famous for, as well as a renewed dedication to new products. You will see the addition of new wire, cable, and accessories to our nine product families. Additionally, we will

be providing solution sets for vertical markets, such as wind power and packaging, to help you select the best Alpha Wire products for the specific needs of your customers or your application.

Xtra-Guard® Performance Cable



Hook-Up Wire



FIT® Heat-Shrink Tubing



Manhattan Electrical Cables



Dearborn™ Marine Cables



FIT Wire Management



Communication, Control & Industrial Cable



Kerrigan-Lewis™ Specialty Wire



FIT Wire Accessories



Xtra-Guard® Performance Cable

Known for both premium performance and system reliability, Xtra-Guard cable is available in several performance grades to give you the best match between cost and environmental and mechanical performance.

- **Xtra-Guard 1** - High-performance in a tough PVC cable
- **Xtra-Guard 2** - Abrasion resistant to withstand mechanical abuse
- **Xtra-Guard 3** - Direct burial cable; no conduit needed
- **Xtra-Guard 4** - Extreme temperatures; handles hot, cold, spills
- **Xtra-Guard 5** - Chemical and temperature resistant to withstand the most hazardous environments
- **Xtra-Guard Flex** - Long-lasting cables rated up to 14 million flex cycles

Alpha Wire Industrial Series

From the factory floor to process control, the Alpha Wire Industrial Series (AWIS) cable line is well suited to the widest range of industrial applications.

- **Series F**
- **Series M**
- **Series P**
- **Series SF**
- **Series V**
- **Series XM**

Manhattan Electrical Cables

Alpha Wire's Manhattan brand has been a trusted and reliable source of cable for over 60 years. You'll find the breadth and depth of products to ensure an optimum solution to your application.

- **Audio/video**
- **Computer**
- **Instrumentation**
- **Thermocouple**
- **Control**
- **Plenum**
- **Coaxial**

- **Cords/cordsets**
- **High temperature**
- **Security & data**

Communication, Control & Industrial Cable



Our broad range of communication and control cables means you can easily find the right cable for your application. Our cables meet special needs, such as low capacitance cables for extended transmission of digital signals, the extra flexibility of rubber insulation and jackets, or excellent shielding for electrically noisy environments.

- **Communication & control**
- **Low smoke, zero halogen**
- **Solar**
- **Industrial automation**
- **Flat cable**

Hook-Up Wire

Find the hook-up wire exactly suited to your application—whether it's as straightforward as a control cabinet in a protected environment or as specialized as a machine tool on the factory floor, a high-temperature oven, or off-road construction equipment. With a broad range of insulation and wire types available, we have everything you need to hook up anything.

- **Hook-up wire**
- **Dearborn bulk hook-up wire**
- **Bus bar**
- **Ribbon cable**

Dearborn Marine

Alpha Wire covers the full spectrum of marine applications. From wiring of engines, batteries, and bilge pumps to cables for communications, instrumentation, and electronics, you will find the exact wire or cable you need. Cables are color-coded to meet boating-industry standards, and specifications ensure regulatory compliance and seaworthiness.

- **Marine wire**
- **Marine cable**
- **Marine heat-shrink tubing**

Kerrigan-Lewis Specialty Wire



Kerrigan-Lewis specialty wire gives exacting performance in transformers, motor windings, and similar applications. From expertise in fine copper and insulations to an exact understanding of your most rigorous application requirements, Alpha can help you increase efficiency, reduce size, and achieve higher levels of productivity. Our specialty wire is available in the lowest minimum order levels in the industry.

- **Litz wire**
- **Resistance wire**

FIT® Heat-Shrink Tubing

Our FIT heat-shrink tubing offers a reliable way to protect and seal terminations, make repairs, or add additional mechanical ruggedness. Whether your concerns are mechanical strain relief, environmental sealing, or organizing wires, our FIT heat-shrink tubing is ideal for solving many challenges in electrical and electronic wiring.

- Shrink ratios from 2:1 to 6:1
- Cross-linked materials
- Shrink temperatures from 90°C to 250°C
- Special shapes, such as endcaps and crimp sleeves
- Dual-wall constructions with inner adhesive lining for additional sealing
- Choice of standard and custom colors



FIT Wire Management

Bringing order to wire harnesses and cable routing means a system that is more reliable, easier to fabricate, and simpler to maintain. Organize, shield, and route cable assemblies and harnesses with our complete line of FIT wire management products in applications such as harnesses, routing, organizing, shielding, and grounding.

- Sleeving
- Tubing
- Braid
- Lacing tape
- EMI tape

FIT Wire Accessories

From variable-setting heat guns for FIT tubing to our full range of wire management accessories, we can help you complete any installation reliably and neatly.

- Heat guns
- Connectors

Customs and Specials

Our capabilities go well beyond our cataloged parts. If you don't find what you need, visit our online Cable Design Center® or give us a call to discuss your needs for:

- Custom designs
- Specials
- Unique packaging
- Legacy products

Xtra-Guard Shielding Options

Alpha Wire offers Xtra-Guard® cables in three shielding options to handle virtually any electrical environment.

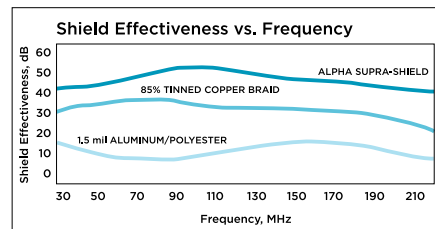

Unshielded

Unshielded cables provide the smallest cable diameter for use in low-noise controlled environments.

Foil shielded

Foil-shielded cables use a sturdy aluminum/polyester shield for moderate EMI needs, especially at lower frequencies. A tinned copper drain wire makes grounding the cable easy. Foil shields allow lighter weights and smaller cables.



Triple-Laminate Foil with 25% Overlap

Supra-Shield® (premium foil/braid) shielded

Alpha's exclusive Supra-Shield cables combine a triple-layer aluminum/polyester/aluminum foil with a tinned copper braid shield with tight 70% coverage. Supra-Shield offers exceptional EMI performance and flexibility to protect against noise and maintain overall system integrity. The combination of foil and braid offers better shielding effectiveness than either approach alone against both low- and high-frequency noise.

Shielding for flex cables

Our high-flex shielding options include a double-jacket configuration with 85% braid coverage to achieve high shielding effectiveness while maintaining the desired flexibility. For torsional flex applications, we offer spiral wound shielding with 90% coverage.

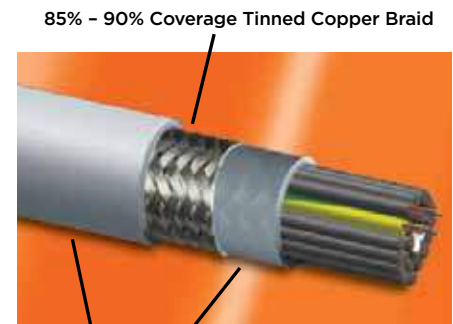

Double Jacket For Outstanding Flexing Performance

The Service You Deserve

We have applied our expertise to creating service that equals our products. Nobody works harder or more diligently to make sure you get the cable you want, when you need it, backed by the service you deserve.

Logistics that defy logic

Need cable tomorrow? No problem. We maintain a large inventory and offer same-day shipping. Order today and receive your order tomorrow in many locations. Alpha Wire goes one step further: manufacturing custom cables to meet unique applications—offering specific conductor counts, shielding options, jacket materials, and versatile product designs. Our custom cable orders are often shipped in less than a week, once again giving you products with more convenience and less delay.

Small put-ups: get what you need

We're geared to ship in small put-ups or large. With Alpha, you don't have to buy more cable than you need because of high minimum order requirements.

Global reach

Encompassing more than 20,000 products and 9 product families available worldwide through more than 1500 distributor locations, Alpha delivers the industry's widest range and largest inventory of wire, cable, and tubing products.



Application expertise

We understand your applications, from the needs of a machine tool cable to withstand coolants and extreme temperatures to the requirements of a wind turbine where robust reliability eliminates service calls.

We've helped companies successfully deploy applications in the frozen tundra, aboard wind- and water-swept offshore drilling rigs, and in the pristine environment of a semiconductor cleanroom.



Online selection made easy

Our new website makes finding the right cable easier than ever. The site's intuitive navigation helps you quickly find the right cable, along with dimensional, material, and performance specifications. Our online Cable Design Center™ lets you build the perfect cable for your application. Plus you can easily build your own catalog and order samples of our products.

Your standards are our standards

We rigorously test our cable to prevailing industry standards. Our cables are approved by such major agencies as UL, CSA, CE, and VDE.

Make Alpha Wire your first choice for reliable performance

We're all about performance—high-performance products and service without compromise or excuse. Whether you're building new products or engaged in MRO, there is no better place to start your search than Alpha Wire. And once you have experienced the Alpha difference, we will become the only source you need.

Get the Alpha Wire Advantage

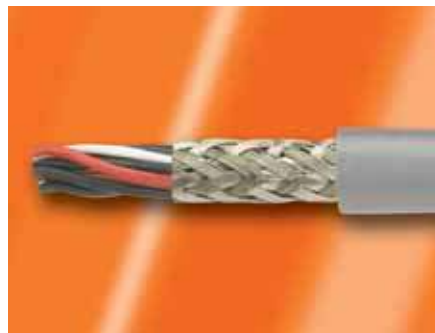
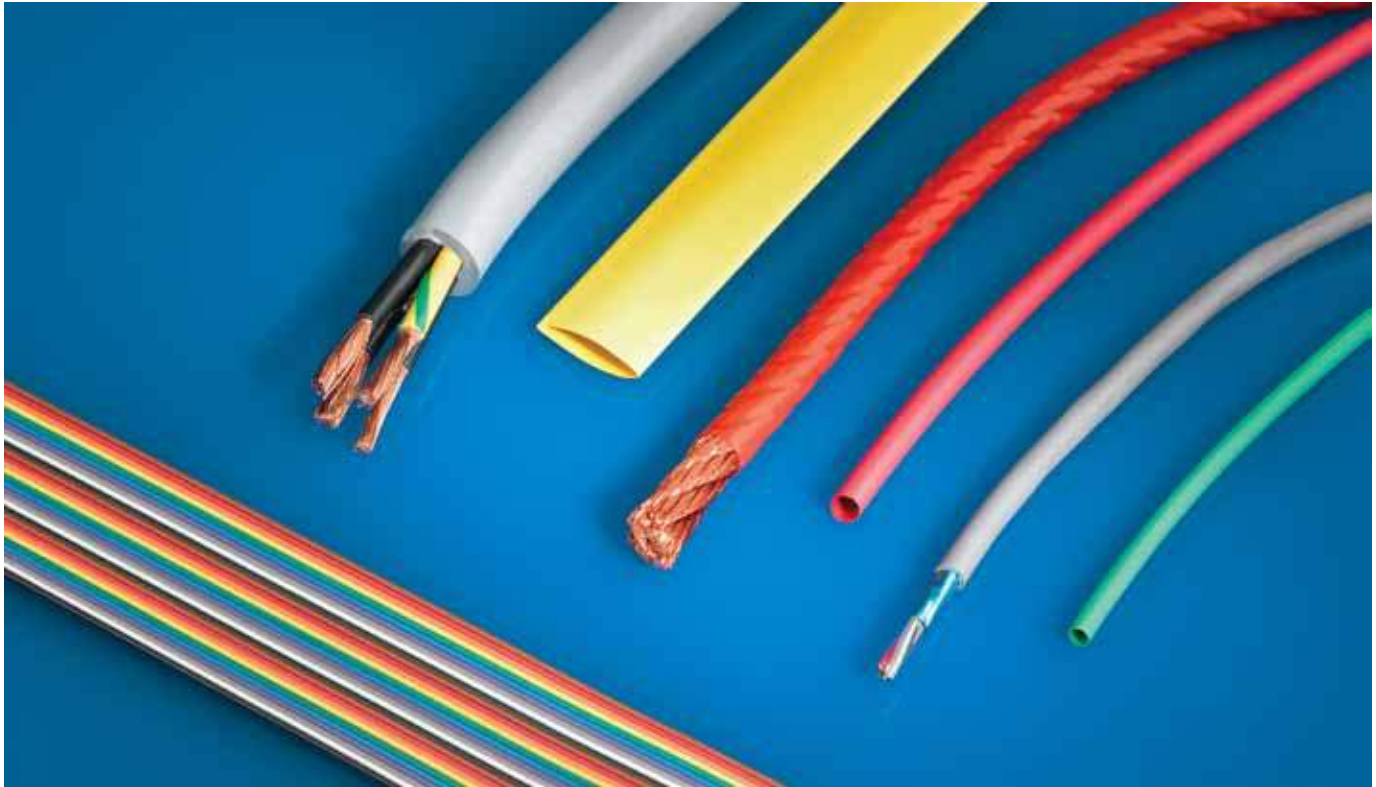

Working closely with industry experts during our 85 year history provides us with the insights and expertise to provide the right wire, cable, and tubing products for your application. Better still, we make it easy with our legendary commitment to service.

Even as our product line has expanded and evolved to meet the needs of new markets and application needs, one thing has remained constant: Alpha's dedication to uncompromising service. We are committed to being your most responsive and easiest to work with supplier.



- Market-specific product solution sets for superior performance and reliability
- Well-earned reputation for high-quality, premium-grade products
- Industry's widest range and largest inventory of wire, cable, and tubing products
- Superior logistics, including same-day shipping
- Fast-turn manufacturing of custom configurations
- Flexible ordering, including small and large put-ups
- Convenient availability through global reach of 3500 distributor locations worldwide
- Unrelenting dedication to making sure you find the right cable to fit your needs
- Online Cable Design Center™ and extensive selection tools to find the right cable or spec a new one

Connect with Alpha Wire

Make the connection with reliable, high-performance wire, cable, tubing, and accessories from Alpha Wire. With our catalog, online resources, authorized distributor network, and Alpha R&D and engineering experts available to you, getting the right Alpha products for your applications is easier than ever—no matter where and when you need them.

Global Headquarters

(North America, South America & Africa)

Alpha Wire

711 Lidgerwood Avenue
Elizabeth, NJ 07207-0711
Toll Free: 1-800-52 ALPHA
Tel: 1-908-925-8000
Fax: 1-908-925-6923
E-mail: info@alphawire.com

European Headquarters

(Europe & Middle East)

Alpha Wire International

Saxon House
1 Downside, Sunbury-on-Thames
Middlesex, United Kingdom TW16 6RT
Tel: +44 (0) 800 288 8809
Fax: +44 (0) 1932 772433
E-mail: europe@alphawire.com

Asia Pacific Headquarters

(Asia & Pacific)

Alpha Wire Asia Pacific

Silver Center, Room 1708
North Shanxi Road 1388
Shanghai, China 200060
Tel: +86-21-61498201/61498205
Fax: +86-21-61498001
E-mail: apac@alphawire.com

Visit us at www.alphawire.com

Xtra-Guard® Performance Cable

Ultimate performance in extreme environments



Xtra-Guard® Performance Cable

Ultimate performance in extreme environments

Alpha Wire's Xtra-Guard cable brings performance and reliability to the biggest challenges in the toughest environments. No matter what extremes your application faces, you'll find an Xtra-Guard cable that excels in meeting your requirements. Downtime is costly—whether caused by a complete cable failure or from the little glitches that occur when a cable doesn't live up to the demands of the application.

Xtra-Guard means peace of mind.

Hazard-matched to survive in the most demanding operating conditions, Xtra-Guard cable is the longest-lasting, highest-performing cable available. Field-proven application performance, year after year, has made Xtra-Guard cable the first choice of engineers for more than three decades.

Superior by design

Xtra-Guard performance cable is designed to meet your needs. Its round construction makes it easier to install, seal, and route. With nearly 5000 standard

constructions and the industry's broadest range of gauges, conductor counts, shielding options, and jacket color choices, Xtra-Guard cable sets the global standard for reliable performance.

Applications

- **Automotive**
- **Industrial**
- **Machine tools**
- **Marine**
- **Medical/biotechnology**
- **Military**
- **Mining**
- **Petrochemical**
- **Semiconductor**
- **Solar**
- **Wind power**

Key features

- **2 to 80 conductors, configured as single conductors or pairs**
- **28 - 14 AWG**
- **Stranded conductors for flexibility**
- **Choice of shielding options:**
 - **Unshielded**
 - **Aluminum/polyester for moderate EMC performance**
 - **Supra-Shield® foil/braid for exceptional EMC performance**

Choose the right Xtra-Guard cable for your application

Xtra-Guard 1

High Performance
High performance in a tough PVC cable

Xtra-Guard 2

Oil and Abrasion Resistant
Abrasion resistant to withstand mechanical abuse

Xtra-Guard 3

Direct Burial
Direct burial—no conduit needed

Xtra-Guard 4

Advanced Temperature and Chemical Performance
Extreme temperature handles hot, cold, spills

Xtra-Guard 5

Maximum Chemical and Temperature Performance
Chemical and temperature resistant to withstand the most hazardous environments

Xtra-Guard Flex

Flexible/Flexing
Wide variety of flexing applications

Xtra-Guard	Application							
	High Temp	Low Temp	UV	Oil/Water/Chemical	Abrasion	Direct Burial	EMI Protection with Supra-Shield	High Flex/Continuous Flex
Xtra-Guard 1	●○○	●○○	●●○	●○○	●○○	NR	●●●	NR
Xtra-Guard 2	●○○	●○○	●●○	●●○	●●●	NR	●●●	NR
Xtra-Guard 3	●○○	●○○	●●○	●●○	●○○	●●●	●●●	NR
Xtra-Guard 4	●●○	●●○	●●○	●●○	●○○	●○○	●●●	NR
Xtra-Guard 5	●●●	●●●	●●●	●●●	●○○	●●○	●●●	NR
Xtra-Guard Flex	●○○	●○○	●○○	●○○ - ●●○	●○○ - ●●○	NR	●●●	●●○ - ●●●

●○○ = Good; ●●○ = Very Good; ●●● = Excellent; NR = Not Recommended

Xtra-Guard® 1

High Performance



Features

- Fast, easy stripping of insulation and jacket
- Color-coded, tinned copper conductors
- Premium-grade PVC insulation and jacket for easier cable routing in small spaces
- 300 V and 600 V
- Unshielded, foil shielded, or Supra-Shield® foil/braid
- 105°C temperature rating
- UL VW-1, UL 1685, and CSA FT-4 flammability rating
- Nylon ripcord for easy jacket stripping

Applications

- EIA RS-232 interface
- High technology applications in controlled environments
- Medical electronics
- Point-of-sale equipment
- Computer peripherals
- Industrial process controls

FIT® Tubing Recommendations

- FIT-221: General-purpose, cross-linked polyolefin (indoor)
- FIT-321: Medium-wall, adhesive-lined, cross-linked polyolefin (outdoor)

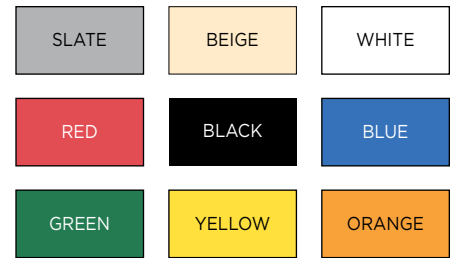

Xtra-Guard cables are available in a range of long-lasting colors for fast, easy identification, for safety reasons, and for matching the color of your system.

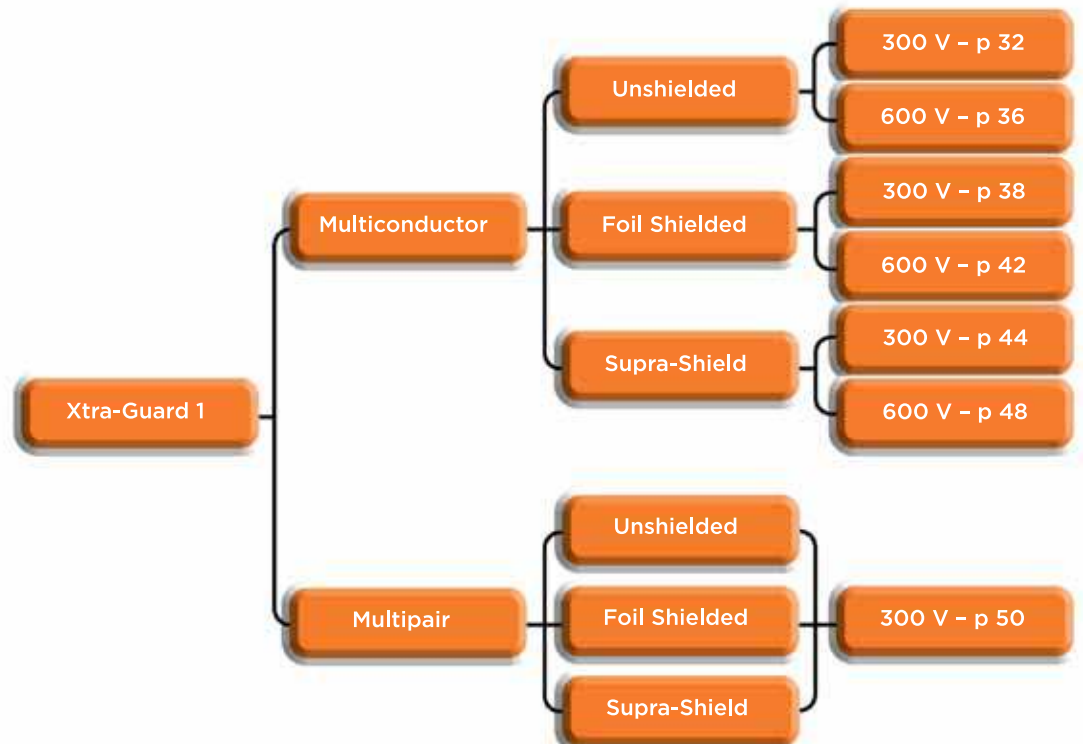



Xtra-Guard® 1

High performance
300 V Unshielded, Multiconductor

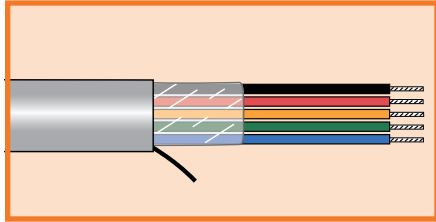

UL CM
UL AWM 2464 VW-1
CSA CMG FT4

Operating Temperature

- -30°C to +80°C (AWM)
- -30°C to +105°C (CM)

Conductor Color Coding

- 28, 26, 24, 22 AWG: Chart E (page 532)
- 20, 18, 16 AWG: Chart D (page 531)
- Jacket Colors
 - Put-ups: slate
 - Bulk: nine colors available (page 31, minimums may apply)

Materials

- Stranded tinned copper conductors
- Premium PVC insulation
- Nylon ripcord
- Premium PVC jacket
- UV resistant

Availability

100 ft (30.5 m)
500 ft (152 m)
1000 ft (305 m)
Bulk, cut to length

FIT® Tubing Recommendations

- FIT-221: General-purpose, cross-linked polyolefin (indoor)
- FIT-321: Medium-wall, adhesive-lined, cross-linked polyolefin (outdoor)

28 AWG (0.09 mm²)

Stranding: 7/36 (7 x 0.127 mm)
Insulation thickness: 0.010 (0.25 mm)

Part Number	Conductors	Nominal Diameter		Jacket Thickness	
		Inch	mm	Inch	mm
5920	2	0.138	3.51	0.032	0.81
5921	3	0.144	3.66	0.032	0.81
5922	4	0.153	3.89	0.032	0.81
5923	6	0.174	4.42	0.032	0.81
5924	7	0.174	4.42	0.032	0.81
5925	8	0.185	4.70	0.032	0.81

26 AWG (0.14 mm²)

Stranding: 7/34 (7 x 0.16 mm)
Insulation thickness: 0.010 (0.25 mm)

Part Number	Conductors	Nominal Diameter		Jacket Thickness	
		Inch	mm	Inch	mm
5666	2	0.146	3.71	0.032	0.81
5667	3	0.152	3.86	0.032	0.81
5668	4	0.162	4.11	0.032	0.81
5669	6	0.186	4.72	0.032	0.81
5670	7	0.186	4.72	0.032	0.81
5671	8	0.198	5.03	0.032	0.81
5672	10	0.224	5.69	0.032	0.81
5673	15	0.248	6.30	0.032	0.81

24 AWG (0.23 mm²)

Stranding: 7/32 (7 x 0.20 mm)
Insulation thickness: 0.010 (0.25 mm)

Part Number	Conductors	Nominal Diameter		Jacket Thickness	
		Inch	mm	Inch	mm
5012C	2	0.156	3.96	0.032	0.81
5013C	3	0.163	4.14	0.032	0.81
5014C	4	0.175	4.45	0.032	0.81
5016C	6	0.201	5.11	0.032	0.81
5018C	8	0.215	5.46	0.032	0.81
5020C	10	0.244	6.20	0.032	0.81
5020/15C	15	0.271	6.88	0.032	0.81
5020/20C	20	0.300	7.62	0.032	0.81
5020/25C	25	0.332	8.43	0.032	0.81
5020/30C	30	0.350	8.89	0.032	0.81
5020/40C	40	0.390	9.91	0.032	0.81
5020/50C	50	0.429	10.90	0.032	0.81





Xtra-Guard® 1

High Performance 300 V Unshielded, Multiconductor

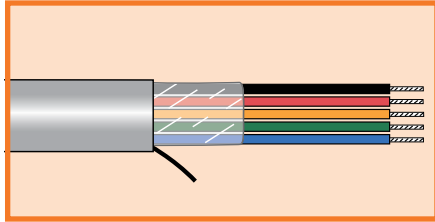

UL CM
UL AWM 2464 VW-1
CSA CMG FT4

Operating Temperature

- -30°C to +80°C (AWM)
- -30°C to +105°C (CM)

Conductor Color Coding

- 28, 26, 24, 22 AWG: Chart E (page 532)
- 20, 18, 16 AWG: Chart D (page 531)
- Jacket Colors
 - Put-ups: slate
 - Bulk: nine colors available (page 31, minimums may apply)

Materials

- Stranded tinned copper conductors
- Premium PVC insulation
- Nylon ripcord
- Premium PVC jacket
- UV resistant

Availability

100 ft (30.5 m)
500 ft (152 m)
1000 ft (305 m)
Bulk, cut to length

FIT® Tubing Recommendations

- FIT-221: General-purpose, cross-linked polyolefin (indoor)
- FIT-321: Medium-wall, adhesive-lined, cross-linked polyolefin (outdoor)

22 AWG (0.35 mm²)

Stranding: 7/30 (7 x 0.25 mm)
Insulation thickness: 0.010 (0.25 mm)

Part Number	Conductors	Nominal Diameter		Jacket Thickness	
		Inch	mm	Inch	mm
5002C	2	0.168	4.27	0.032	0.81
5003C	3	0.176	4.47	0.032	0.81
5004C	4	0.189	4.80	0.032	0.81
5006C	6	0.219	5.56	0.032	0.81
5008C	8	0.235	5.97	0.032	0.81
5010C	10	0.268	6.81	0.032	0.81
5010/15C	15	0.299	7.59	0.032	0.81
5010/20C	20	0.331	8.41	0.032	0.81
5010/25C	25	0.368	9.35	0.032	0.81
5010/30C	30	0.389	9.88	0.032	0.81
5010/40C	40	0.434	11.02	0.032	0.81
5010/50C	50	0.478	12.14	0.032	0.81
5010/60C	60	0.518	13.16	0.032	0.81

20 AWG (0.56 mm²)

Stranding: 7/28 (7 x 0.32 mm)
Insulation thickness: 0.016 (0.41 mm)

Part Number	Conductors	Nominal Diameter		Jacket Thickness	
		Inch	mm	Inch	mm
5052C	2	0.208	5.28	0.032	0.81
5053C	3	0.219	5.56	0.032	0.81
5054C	4	0.238	6.05	0.032	0.81
5056C	6	0.280	7.11	0.032	0.81
5058C	8	0.302	7.67	0.032	0.81
5060C	10	0.348	8.84	0.032	0.81
5060/15C	15	0.391	9.93	0.032	0.81
5060/20C	20	0.437	11.10	0.032	0.81
5060/25C	25	0.488	12.40	0.032	0.81
5060/30C	30	0.517	13.13	0.032	0.81
5060/40C	40	0.622	15.80	0.053	1.35
5060/50C	50	0.684	17.37	0.053	1.35





Xtra-Guard® 1

High Performance 300 V Unshielded, Multiconductor

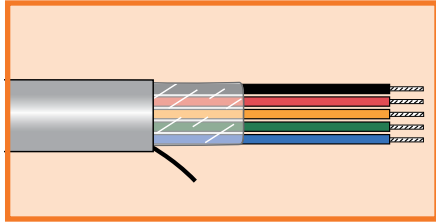

UL CM
UL AWM 2464 VW-1
CSA CMG FT4

Operating Temperature

- -30°C to +80°C (AWM)
- -30°C to +105°C (CM)

Conductor Color Coding

- 28, 26, 24, 22 AWG: Chart E (page 532)
- 20, 18, 16 AWG: Chart D (page 531)
- Jacket Colors
 - Put-ups: slate
 - Bulk: nine colors available (page 31, minimums may apply)

Materials

- Stranded tinned copper conductors
- Premium PVC insulation
- Nylon ripcord
- Premium PVC jacket
- UV resistant

Availability

100 ft (30.5 m)
500 ft (152 m)
1000 ft (305 m)
Bulk, cut to length

FIT® Tubing Recommendations

- FIT-221: General-purpose, cross-linked polyolefin (indoor)
- FIT-321: Medium-wall, adhesive-lined, cross-linked polyolefin (outdoor)

18 AWG (0.81 mm²)

Stranding: 16/30 (16 x 0.25 mm)
Insulation thickness: 0.016 (0.41 mm)

Part Number	Conductors	Nominal Diameter		Jacket Thickness	
		Inch	mm	Inch	mm
5062/1C*	2	0.226	5.74	0.032	0.81
5062C	2	0.226	5.74	0.032	0.81
5063/1C*	3	0.238	6.05	0.032	0.81
5063C	3	0.238	6.05	0.032	0.81
5064C	4	0.259	6.58	0.032	0.81
5066C	6	0.307	7.80	0.032	0.81
5068C	8	0.332	8.43	0.032	0.81
5070C	10	0.384	9.75	0.032	0.81
5070/15C	15	0.433	11.00	0.032	0.81
5070/20C	20	0.484	12.29	0.032	0.81
5070/25C	25	0.542	13.77	0.032	0.81
5070/30C	30	0.617	15.67	0.053	1.35
5070/40C	40	0.688	17.48	0.053	1.35
5070/50C	50	0.758	19.25	0.053	1.35
5070/60C	60	0.881	22.38	0.083	2.11

*Conductors color-coded per international standards: brown, blue, green/yellow.

16 AWG (1.23 mm²)

Stranding: 19/0.0117 (19 x 0.29 mm)
Insulation thickness: 0.016 (0.41 mm)

Part Number	Conductors	Nominal Diameter		Jacket Thickness	
		Inch	mm	Inch	mm
5072/1C*	2	0.250	6.35	0.032	0.81
5072C	2	0.250	6.35	0.032	0.81
5073/1C*	3	0.264	6.71	0.032	0.81
5073C	3	0.264	6.71	0.032	0.81
5074C	4	0.288	7.32	0.032	0.81
5076C	6	0.343	8.71	0.032	0.81
5078C	8	0.372	9.45	0.032	0.81
5080C	10	0.432	10.97	0.032	0.81
5080/15C	15	0.488	12.40	0.032	0.81
5080/20C	20	0.547	13.89	0.053	0.81
5080/25C	25	0.656	16.66	0.053	0.81
5080/30C	30	0.694	17.63	0.053	0.81
5080/40C	40	0.775	19.69	0.083	2.11
5080/50C	50	0.917	23.29	0.083	2.11

*Conductors color-coded per international standards: brown, blue, green/yellow.





Xtra-Guard® 1

High Performance 300 V Unshielded, Multiconductor

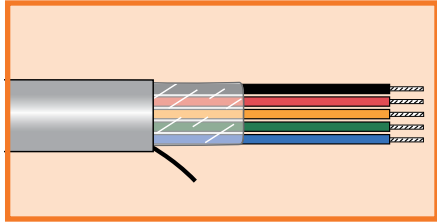

UL CM
UL AWM 2343 VW-1
CSA CMG FT4

Operating Temperature

- -30°C to +80°C (AWM)
- -30°C to +105°C (CM)

Conductor Color Coding

- Chart E (page 532)
- Jacket Colors
 - Put-ups: slate
 - Bulk: nine colors available (page 31, minimums may apply)

Materials

- Stranded tinned copper conductors
- Premium PVC insulation
- Nylon ripcord
- Premium PVC jacket
- UV resistant

Availability

100 ft (30.5 m)
500 ft (152 m)
1000 ft (305 m)
Bulk, cut to length

FIT® Tubing Recommendations

- FIT-221: General-purpose, cross-linked polyolefin (indoor)
- FIT-321: Medium-wall, adhesive-lined, cross-linked polyolefin (outdoor)

24 AWG (0.23 mm ²)					
Stranding: 7/32 (7 x 0.20 mm)					
Insulation thickness: 0.010 (0.25 mm)					
Part Number	Conductors	Nominal Diameter		Jacket Thickness	
		Inch	mm	Inch	mm
5201C	7	0.263	6.68	0.063	1.60
5202C	12	0.313	7.95	0.063	1.60
5203C	15	0.333	8.46	0.063	1.60
5204C	19	0.350	8.89	0.063	1.60
5206C	37	0.438	11.13	0.063	1.60

22 AWG (0.35 mm ²)					
Stranding: 7/30 (7 x 0.25 mm)					
Insulation thickness: 0.010 (0.25 mm)					
Part Number	Conductors	Nominal Diameter		Jacket Thickness	
		Inch	mm	Inch	mm
5210/2C	2	0.230	5.84	0.063	1.60
5211C	7	0.281	7.14	0.063	1.60
5212C	12	0.338	8.59	0.063	1.60
5213C	15	0.361	9.17	0.063	1.60
5214C	19	0.380	9.65	0.063	1.60
5214/25C	25	0.430	10.92	0.063	1.60
5215C	27	0.438	11.13	0.063	1.60
5216C	37	0.480	12.19	0.063	1.60

20 AWG (0.56 mm ²)					
Stranding: 7/28 (7 x 0.32 mm)					
Insulation thickness: 0.010 (0.25 mm)					
Part Number	Conductors	Nominal Diameter		Jacket Thickness	
		Inch	mm	Inch	mm
5220/2C	2	0.246	6.25	0.063	1.60
5220C	5	0.288	7.32	0.063	1.60
5221C	7	0.305	7.75	0.063	1.60
5222C	12	0.371	9.42	0.063	1.60
5223C	15	0.398	10.11	0.063	1.60
5224C	19	0.420	10.67	0.063	1.60
5224/25C	25	0.478	12.14	0.063	1.60
5225C	27	0.487	12.37	0.063	1.60
5226C	37	0.536	13.61	0.063	1.60





Xtra-Guard® 1

High Performance 600 V Unshielded, Multiconductor

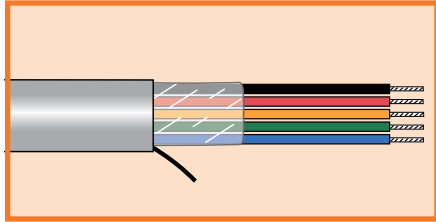

UL CM
UL AWM 2501 VW-1
UL MTW
CSA AWM I/II A/B FT4

Operating Temperature

- -30°C to +105°C
- -30°C to +90°C (MTW)

Conductor Color Coding

- Chart E (page 532)
- Jacket Colors
 - Put-ups: slate
 - Bulk: nine colors available (page 31, minimums may apply)

Materials

- Stranded tinned copper conductors
- Premium PVC insulation
- Nylon ripcord
- Premium PVC jacket
- UV resistant

Availability

100 ft (30.5 m)
500 ft (152 m)
1000 ft (305 m)
Bulk, cut to length

FIT® Tubing Recommendations

- FIT-221: General-purpose, cross-linked polyolefin (indoor)
- FIT-321: Medium-wall, adhesive-lined, cross-linked polyolefin (outdoor)

22 AWG (0.35 mm²)

Stranding: 7/30 (7 x 0.25 mm)
Insulation thickness: 0.032 (0.81 mm)

Part Number	Conductors	Nominal Diameter		Jacket Thickness	
		Inch	mm	Inch	mm
5402	2	0.318	8.08	0.063	1.60
5404	4	0.358	9.09	0.063	1.60
5405	5	0.385	9.78	0.063	1.60
5409	9	0.473	12.01	0.063	1.60
5409/19	19	0.601	15.27	0.063	1.60

20 AWG (0.56 mm²)

Stranding: 7/28 (7 x 0.32 mm)
Insulation thickness: 0.032 (0.81 mm)

Part Number	Conductors	Nominal Diameter		Jacket Thickness	
		Inch	mm	Inch	mm
5413	3	0.350	8.89	0.063	1.60
5414	4	0.377	9.58	0.063	1.60
5419	9	0.503	12.78	0.063	1.60
5419/12	12	0.554	14.07	0.063	1.60
5419/15	15	0.601	15.27	0.063	1.60
5419/19	19	0.641	16.28	0.063	1.60
5419/25	25	0.742	18.85	0.063	1.60

18 AWG (0.81 mm²)

Stranding: 16/30 (16 x 0.25 mm)
Insulation thickness: 0.032 (0.81 mm)

Part Number	Conductors	Nominal Diameter		Jacket Thickness	
		Inch	mm	Inch	mm
5422	2	0.352	8.94	0.063	1.60
5423	3	0.369	9.37	0.063	1.60
5424	4	0.399	10.13	0.063	1.60
5425	5	0.432	10.97	0.063	1.60
5427	7	0.466	11.84	0.063	1.60
5429	9	0.535	13.59	0.063	1.60
5429/15	15	0.643	16.33	0.063	1.60
5429/19	19	0.686	17.42	0.063	1.60
5429/25	25	0.796	20.22	0.063	1.60





Xtra-Guard® 1

High Performance 600 V Unshielded, Multiconductor

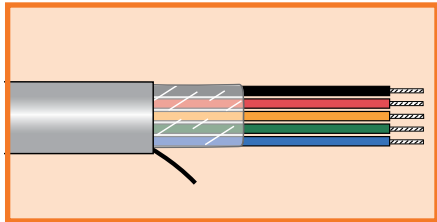

UL CM
UL AWM 2501 VW-1
UL MTW
CSA AWM I/II A/B FT4
Operating Temperature

- -30°C to +105°C
- -30°C to +90°C (MTW)

Conductor Color Coding

- Chart E (page 532)
- Jacket Colors
 - Put-ups: slate
 - Bulk: nine colors available (page 31, minimums may apply)

Materials

- Stranded tinned copper conductors
- Premium PVC insulation
- Nylon ripcord
- Premium PVC jacket
- UV resistant

Availability

100 ft (30.5 m)
 500 ft (152 m)
 1000 ft (305 m)
 Bulk, cut to length

FIT® Tubing Recommendations

- FIT-221: General-purpose, cross-linked polyolefin (indoor)
- FIT-321: Medium-wall, adhesive-lined, cross-linked polyolefin (outdoor)

16 AWG (1.23 mm²)

Stranding: 19/0.0117 (19 x 0.29 mm)
 Insulation thickness: 0.032 (0.81 mm)

Part Number	Conductors	Nominal Diameter		Jacket Thickness	
		Inch	mm	Inch	mm
5434	4	0.428	10.87	0.063	1.60
5435	5	0.464	11.79	0.063	1.60
5437	7	0.502	12.75	0.063	1.60
5439	9	0.579	14.71	0.063	1.60
5439/12	12	0.641	16.28	0.063	1.60
5439/15	15	0.698	17.73	0.063	1.60
5439/19	19	0.746	18.95	0.083	2.11
5439/25	25	0.908	23.06	0.083	2.11

14 AWG (2.08 mm²)

Stranding: 41/30 (41 x 0.25 mm)
 Insulation thickness: 0.032 (0.81 mm)

Part Number	Conductors	Nominal Diameter		Jacket Thickness	
		Inch	mm	Inch	mm
5442	2	0.406	10.31	0.063	1.60
5443	3	0.428	10.87	0.063	1.60
5444	4	0.464	11.79	0.063	1.60
5445	5	0.505	12.83	0.063	1.60
5447	7	0.547	13.89	0.063	1.60
5449	9	0.634	16.10	0.063	1.60
5449/12	12	0.703	17.86	0.063	1.60
5449/15	15	0.767	19.48	0.063	1.60
5449/25	25	0.998	25.35	0.083	2.11





Xtra-Guard® 1

High Performance 300 V Foil Shielded, Multiconductor

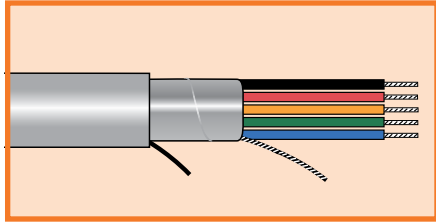

UL CM
UL AWM 2464 VW-1
CSA CMG FT4

Operating Temperature

- -30°C to +80°C (AWM)
- -30°C to +105°C (CM)

Conductor Color Coding

- 28, 26, 24, 22 AWG: Chart E (page 532)
- 20, 18, 16 AWG: Chart D (page 531)
- Jacket Colors
 - Put-ups: slate
 - Bulk: nine colors available (page 31, minimums may apply)

Materials

- Stranded tinned copper conductors
- Premium PVC insulation
- Aluminum/polyester foil shield, with 25% overlap and foil facing inward
- Tinned copper drain wire sized the same as cable conductors
- Nylon ripcord
- Premium PVC jacket
- UV resistant

Availability

100 ft (30.5 m)
500 ft (152 m)
1000 ft (305 m)
Bulk, cut to length

FIT® Tubing Recommendations

- FIT-221: General-purpose, cross-linked polyolefin (indoor)
- FIT-321: Medium-wall, adhesive-lined, cross-linked polyolefin (outdoor)



28 AWG (0.09 mm²)

Stranding: 7/36 (7 x 0.127 mm)
Insulation thickness: 0.010 (0.25 mm)

Part Number	Conductors	Nominal Diameter		Jacket Thickness	
		Inch	mm	Inch	mm
5926	2	0.142	3.61	0.032	0.81
5927	3	0.148	3.76	0.032	0.81
5928	4	0.157	3.99	0.032	0.81
5929	6	0.178	4.52	0.032	0.81
5930	7	0.178	4.52	0.032	0.81
5931	8	0.189	4.80	0.032	0.81

26 AWG (0.14 mm²)

Stranding: 7/34 (7 x 0.16 mm)
Insulation thickness: 0.010 (0.25 mm)

Part Number	Conductors	Nominal Diameter		Jacket Thickness	
		Inch	mm	Inch	mm
5674	2	0.150	3.81	0.032	0.81
5675	3	0.156	3.96	0.032	0.81
5676	4	0.166	4.22	0.032	0.81
5677	6	0.190	4.83	0.032	0.81
5678	7	0.190	4.83	0.032	0.81
5679	8	0.202	5.13	0.032	0.81
5680	10	0.228	5.79	0.032	0.81
5681	15	0.252	6.40	0.032	0.81

24 AWG (0.23 mm²)

Stranding: 7/32 (7 x 0.20 mm)
Insulation thickness: 0.010 (0.25 mm)

Part Number	Conductors	Nominal Diameter		Jacket Thickness	
		Inch	mm	Inch	mm
5092C	2	0.160	4.06	0.032	0.81
5093C	3	0.167	4.24	0.032	0.81
5094C	4	0.179	4.55	0.032	0.81
5096C	6	0.205	5.21	0.032	0.81
5098C	8	0.219	5.56	0.032	0.81
5100C	10	0.248	6.30	0.032	0.81
5100/15C	15	0.275	6.99	0.032	0.81
5100/20C	20	0.304	7.72	0.032	0.81
5100/25C	25	0.336	8.53	0.032	0.81
5100/30C	30	0.354	8.99	0.032	0.81
5100/40C	40	0.394	10.01	0.032	0.81
5100/50C	50	0.433	11.00	0.032	0.81
5100/60C	60	0.468	11.89	0.032	0.81
5100/70C	70	0.505	12.83	0.032	0.81



Xtra-Guard® 1

High Performance 300 V Foil Shielded, Multiconductor

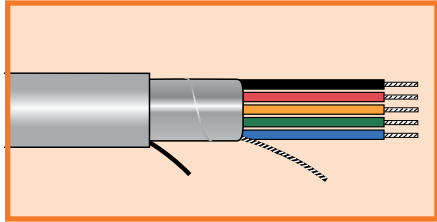

UL CM
UL AWM 2464 VW-1
CSA CMG FT4

Operating Temperature

- -30°C to +80°C (AWM)
- -30°C to +105°C (CM)

Conductor Color Coding

- 28, 26, 24, 22 AWG: Chart E (page 532)
- 20, 18, 16 AWG: Chart D (page 531)
- Jacket Colors
 - Put-ups: slate
 - Bulk: nine colors available (page 31, minimums may apply)

Materials

- Stranded tinned copper conductors
- Premium PVC insulation
- Aluminum/polyester foil shield, with 25% overlap and foil facing inward
- Tinned copper drain wire sized the same as cable conductors
- Nylon ripcord
- Premium PVC jacket
- UV resistant

Availability

100 ft (30.5 m)
500 ft (152 m)
1000 ft (305 m)
Bulk, cut to length

FIT® Tubing Recommendations

- FIT-221: General-purpose, cross-linked polyolefin (indoor)
- FIT-321: Medium-wall, adhesive-lined, cross-linked polyolefin (outdoor)



22 AWG (0.35 mm²)

Stranding: 7/30 (7 x 0.25 mm)
Insulation thickness: 0.010 (0.25 mm)

Part Number	Conductors	Nominal Diameter		Jacket Thickness	
		Inch	mm	Inch	mm
5192C	2	0.172	4.37	0.032	0.81
5193C	3	0.180	4.57	0.032	0.81
5194C	4	0.193	4.90	0.032	0.81
5196C	6	0.223	5.66	0.032	0.81
5198C	8	0.239	6.07	0.032	0.81
5199/10C	10	0.272	6.91	0.032	0.81
5199/15C	15	0.303	7.70	0.032	0.81
5199/20C	20	0.335	8.51	0.032	0.81
5199/25C	25	0.372	9.45	0.032	0.81
5199/30C	30	0.393	9.98	0.032	0.81
5199/40C	40	0.438	11.13	0.032	0.81
5199/50C	50	0.482	12.24	0.032	0.81
5199/60C	60	0.522	13.26	0.032	0.81
5199/70C	70	0.606	15.39	0.053	1.35

20 AWG (0.56 mm²)

Stranding: 7/28 (7 x 0.32 mm)
Insulation thickness: 0.016 (0.41 mm)

Part Number	Conductors	Nominal Diameter		Jacket Thickness	
		Inch	mm	Inch	mm
5462C	2	0.212	5.38	0.032	0.81
5463C	3	0.223	5.66	0.032	0.81
5464C	4	0.242	6.15	0.032	0.81
5466C	6	0.284	7.21	0.032	0.81
5468C	8	0.306	7.77	0.032	0.81
5470C	10	0.352	8.94	0.032	0.81
5470/15C	15	0.395	10.03	0.032	0.81
5470/20C	20	0.441	11.20	0.032	0.81
5470/25C	25	0.492	12.50	0.032	0.81
5470/30C	30	0.521	13.23	0.032	0.81
5470/40C	40	0.626	15.90	0.053	1.35
5470/50C	50	0.688	17.48	0.053	1.35



Xtra-Guard® 1

High Performance 300 V Foil Shielded, Multiconductor

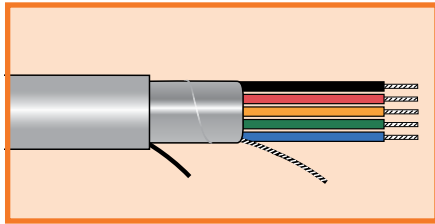

UL CM
UL AWM 2464 VW-1
CSA CMG FT4

Operating Temperature

- -30°C to +80°C (AWM)
- -30°C to +105°C (CM)

Conductor Color Coding

- 28, 26, 24, 22 AWG: Chart E (page 532)
- 20, 18, 16 AWG: Chart D (page 531)
- Jacket Colors
 - Put-ups: slate
 - Bulk: nine colors available (page 31, minimums may apply)

Materials

- Stranded tinned copper conductors
- Premium PVC insulation
- Aluminum/polyester foil shield, with 25% overlap and foil facing inward
- Tinned copper drain wire sized the same as cable conductors
- Nylon ripcord
- Premium PVC jacket
- UV resistant

Availability

100 ft (30.5 m)
500 ft (152 m)
1000 ft (305 m)
Bulk, cut to length

FIT® Tubing Recommendations

- FIT-221: General-purpose, cross-linked polyolefin (indoor)
- FIT-321: Medium-wall, adhesive-lined, cross-linked polyolefin (outdoor)



18 AWG (0.81 mm²)

Stranding: 16/30 (16 x 0.25 mm)
Insulation thickness: 0.016 (0.41 mm)

Part Number	Conductors	Nominal Diameter		Jacket Thickness	
		Inch	mm	Inch	mm
5382C	2	0.230	5.84	0.032	0.81
5382/1C*	2	0.230	5.84	0.032	0.81
5383C	3	0.242	6.15	0.032	0.81
5383/1C*	3	0.242	6.15	0.032	0.81
5384C	4	0.263	6.68	0.032	0.81
5386C	6	0.311	7.90	0.032	0.81
5388C	8	0.336	8.53	0.032	0.81
5390C	10	0.388	9.86	0.032	0.81
5390/15C	15	0.437	11.10	0.032	0.81
5390/20C	20	0.488	12.40	0.032	0.81
5390/25C	25	0.588	14.94	0.053	1.35
5390/30C	30	0.621	15.77	0.053	1.35
5390/40C	40	0.692	17.58	0.053	1.35
5390/50C	50	0.762	19.35	0.053	1.35
5390/60C	60	0.885	22.48	0.083	2.11

*Conductors color-coded per international standards: brown, blue, green/yellow.

16 AWG (1.23 mm²)

Stranding: 19/0.0117 (19 x 0.29 mm)
Insulation thickness: 0.016 (0.41 mm)

Part Number	Conductors	Nominal Diameter		Jacket Thickness	
		Inch	mm	Inch	mm
5362C	2	0.254	6.45	0.032	0.81
5362/1C*	2	0.254	6.45	0.032	0.81
5363C	3	0.268	6.81	0.032	0.81
5363/1C*	3	0.268	6.81	0.032	0.81
5364C	4	0.292	7.42	0.032	0.81
5366C	6	0.347	8.81	0.032	0.81
5368C	8	0.376	9.55	0.032	0.81
5370C	10	0.436	11.07	0.032	0.81
5370/15C	15	0.492	12.50	0.032	0.81
5370/20C	20	0.593	15.06	0.053	1.35
5370/25C	25	0.660	16.76	0.053	1.35
5370/30C	30	0.698	17.73	0.053	1.35
5370/40C	40	0.779	19.79	0.083	2.11

*Conductors color-coded per international standards: brown, blue, green/yellow.



Xtra-Guard® 1

High Performance 300 V Foil Shielded, Multiconductor

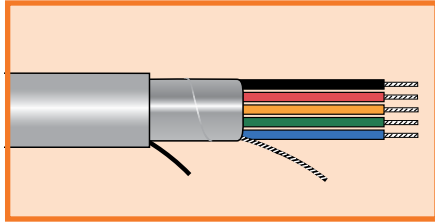

UL CM
UL AWM 2343 VW-1
CSA CMG FT4

Operating Temperature

- -30°C to +80°C (AWM)
- -30°C to +105°C (CM)

Conductor Color Coding

- Chart E (page 532)
- Jacket Colors
 - Put-ups: slate
 - Bulk: nine colors available (page 31, minimums may apply)

Materials

- Stranded tinned copper conductors
- Premium PVC insulation
- Aluminum/polyester foil shield, with 25% overlap and foil facing inward
- Tinned copper drain wire sized the same as cable conductors
- Nylon ripcord
- Premium PVC jacket
- UV resistant

Availability

100 ft (30.5 m)
500 ft (152 m)
1000 ft (305 m)
Bulk, cut to length

FIT® Tubing Recommendations

- FIT-221: General-purpose, cross-linked polyolefin (indoor)
- FIT-321: Medium-wall, adhesive-lined, cross-linked polyolefin (outdoor)

24 AWG (0.23 mm ²)					
Stranding: 7/32 (7 x 0.20 mm) Insulation thickness: 0.010 (0.25 mm)					
Part Number	Conductors	Nominal Diameter		Jacket Thickness	
		Inch	mm	Inch	mm
5599/3C	3	0.229	5.82	0.063	1.60
5599/5C	5	0.254	6.45	0.063	1.60
5599/7C	7	0.267	6.78	0.063	1.60
5599/12C	12	0.317	8.05	0.063	1.60
5599/15C	15	0.337	8.56	0.063	1.60
5599/19C	19	0.354	8.99	0.063	1.60
5599/27C	27	0.405	10.29	0.063	1.60

22 AWG (0.35 mm ²)					
Stranding: 7/30 (7 x 0.25 mm) Insulation thickness: 0.010 (0.25 mm)					
Part Number	Conductors	Nominal Diameter		Jacket Thickness	
		Inch	mm	Inch	mm
5580/2C	2	0.234	5.94	0.063	1.60
5580C	5	0.270	6.86	0.063	1.60
5581C	7	0.285	7.24	0.063	1.60
5582C	12	0.342	8.69	0.063	1.60
5583C	15	0.365	9.27	0.063	1.60
5584C	19	0.384	9.75	0.063	1.60
5586C	37	0.484	12.29	0.063	1.60

20 AWG (0.56 mm ²)					
Stranding: 7/28 (7 x 0.32 mm) Insulation thickness: 0.010 (0.25 mm)					
Part Number	Conductors	Nominal Diameter		Jacket Thickness	
		Inch	mm	Inch	mm
5560/2C	2	0.250	6.35	0.063	1.60
5560C	5	0.292	7.42	0.063	1.60
5561C	7	0.309	7.85	0.063	1.60
5562C	12	0.375	9.53	0.063	1.60
5563C	15	0.402	10.21	0.063	1.60
5564C	19	0.424	10.77	0.063	1.60





Xtra-Guard® 1

High Performance 600 V Foil Shielded, Multiconductor

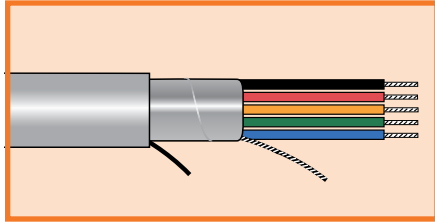

UL AWM 2501 VW-1
CSA AWM I/II A/B FT4
UL MTW

Operating Temperature

- 30°C to +105°C (AWM)
- 30°C to +90°C (MTW)

Conductor Color Coding

- Chart E (page 532)
- Jacket Colors
 - Put-ups: slate
 - Bulk: nine colors available (page 31, minimums may apply)

Materials

- Stranded tinned copper conductors
- Premium PVC insulation
- Aluminum/polyester foil shield, with 25% overlap and foil facing inward
- Tinned copper drain wire sized the same as cable conductors
- Nylon ripcord
- Premium PVC jacket
- UV resistant

Availability

100 ft (30.5 m)
500 ft (152 m)
1000 ft (305 m)
Bulk, cut to length

FIT® Tubing Recommendations

- FIT-221: General-purpose, cross-linked polyolefin (indoor)
- FIT-321: Medium-wall, adhesive-lined, cross-linked polyolefin (outdoor)



22 AWG (0.35 mm²)

Stranding: 7/30 (7 x 0.25 mm)
Insulation thickness: 0.032 (0.81 mm)

Part Number	Conductors	Nominal Diameter		Jacket Thickness	
		Inch	mm	Inch	mm
5410/2	2	0.322	8.18	0.063	1.60
5410/3	3	0.337	8.56	0.063	1.60
5410/4	4	0.362	9.19	0.063	1.60
5410/5	5	0.389	9.88	0.063	1.60
5410/9	9	0.477	12.12	0.063	1.60
5410/12	12	0.525	13.34	0.063	1.60

20 AWG (0.56 mm²)

Stranding: 7/28 (7 x 0.32 mm)
Insulation thickness: 0.032 (0.81 mm)

Part Number	Conductors	Nominal Diameter		Jacket Thickness	
		Inch	mm	Inch	mm
5420/3	3	0.354	8.99	0.063	1.60
5420/4	4	0.381	9.68	0.063	1.60
5420/5	5	0.411	10.44	0.063	1.60
5420/7	7	0.442	11.23	0.063	1.60
5420/9	9	0.507	12.88	0.063	1.60
5420/12	12	0.558	14.17	0.063	1.60

18 AWG (0.81 mm²)

Stranding: 16/30 (16 x 0.25 mm)
Insulation thickness: 0.032 (0.81 mm)

Part Number	Conductors	Nominal Diameter		Jacket Thickness	
		Inch	mm	Inch	mm
5430/2	2	0.356	9.04	0.063	1.60
5430/3	3	0.373	9.47	0.063	1.60
5430/4	4	0.403	10.24	0.063	1.60
5430/5	5	0.436	11.07	0.063	1.60
5430/7	7	0.470	11.94	0.063	1.60
5430/9	9	0.539	13.69	0.063	1.60
5430/12	12	0.595	15.11	0.063	1.60
5430/15	15	0.647	16.43	0.063	1.60
5430/19	19	0.690	17.53	0.063	1.60
5430/25	25	0.800	20.32	0.063	1.60



Xtra-Guard® 1

High Performance 600 V Foil Shielded, Multiconductor

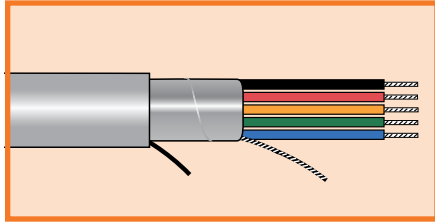

UL AWM 2501 VW-1
CSA AWM I/II A/B FT4
UL MTW

Operating Temperature

- -30°C to +105°C (AWM)
- -30°C to +90°C (MTW)

Conductor Color Coding

- Chart E (page 532)
- Jacket Colors
 - Put-ups: slate
 - Bulk: nine colors available (page 31, minimums may apply)

Materials

- Stranded tinned copper conductors
- Premium PVC insulation
- Aluminum/polyester foil shield, with 25% overlap and foil facing inward
- Tinned copper drain wire sized the same as cable conductors
- Nylon ripcord
- Premium PVC jacket
- UV resistant

Availability

100 ft (30.5 m)
500 ft (152 m)
1000 ft (305 m)
Bulk, cut to length

FIT® Tubing Recommendations

- FIT-221: General-purpose, cross-linked polyolefin (indoor)
- FIT-321: Medium-wall, adhesive-lined, cross-linked polyolefin (outdoor)



16 AWG (1.23 mm²)

Stranding: 19/0.0117 (19 x 0.29 mm)
Insulation thickness: 0.032 (0.81 mm)

Part Number	Conductors	Nominal Diameter		Jacket Thickness	
		Inch	mm	Inch	mm
5440/2	2	0.380	9.65	0.063	1.60
5440/3	3	0.399	10.13	0.063	1.60
5440/4	4	0.432	10.97	0.063	1.60
5440/5	5	0.468	11.89	0.063	1.60
5440/7	7	0.506	12.85	0.063	1.60
5440/9	9	0.583	14.81	0.063	1.60
5440/12	12	0.645	16.38	0.063	1.60
5440/15	15	0.702	17.83	0.063	1.60

14 AWG (2.08 mm²)

Stranding: 41/30 (41 x 0.25 mm)
Insulation thickness: 0.032 (0.81 mm)

Part Number	Conductors	Nominal Diameter		Jacket Thickness	
		Inch	mm	Inch	mm
5450/2	2	0.410	10.41	0.063	1.60
5450/3	3	0.432	10.97	0.063	1.60
5450/4	4	0.468	11.89	0.063	1.60
5450/5	5	0.509	12.93	0.063	1.60
5450/7	7	0.551	14.00	0.063	1.60
5450/12	12	0.707	17.96	0.063	1.60



Xtra-Guard® 1

High Performance

300 V Supra-Shield® Foil/Braid, Multiconductor

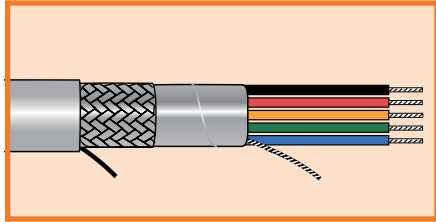

UL CM
UL AWM 2464 VW-1
CSA CMG FT4

Operating Temperature

- -30°C to +80°C (AWM)
- -30°C to +105°C (CM)

Conductor Color Coding

- 28, 26, 24, 22 AWG: Chart E (page 532)
- 20, 18, 16 AWG: Chart D (page 531)
- Jacket Colors
 - Put-ups: slate
 - Bulk: nine colors available (page 31, minimums may apply)

Materials

- Stranded tinned copper conductors
- Premium PVC insulation
- Supra-Shield foil + braid shield: Aluminum/polyester/aluminum foil with 25% overlap min. Tinned copper drain wire sized the same as conductors
- Tinned copper braid, 70% coverage min.
- Nylon ripcord
- Premium PVC jacket
- UV resistant

Availability

100 ft (30.5 m)
 500 ft (152 m)
 1000 ft (305 m)
 Bulk, cut to length

FIT® Tubing Recommendations

- FIT-221: General-purpose, cross-linked polyolefin (indoor)
- FIT-321: Medium-wall, adhesive-lined, cross-linked polyolefin (outdoor)

28 AWG (0.09 mm²)

Stranding: 7/36 (7 x 0.127 mm)
 Insulation thickness: 0.010 (0.25 mm)

Part Number	Conductors	Nominal Diameter		Jacket Thickness	
		Inch	mm	Inch	mm
5932	2	0.166	4.22	0.032	0.81
5933	3	0.172	4.37	0.032	0.81
5934	4	0.181	4.60	0.032	0.81
5935	6	0.202	5.13	0.032	0.81
5936	7	0.202	5.13	0.032	0.81
5937	8	0.213	5.41	0.032	0.81

26 AWG (0.14 mm²)

Stranding: 7/34 (7 x 0.16 mm)
 Insulation thickness: 0.010 (0.25 mm)

Part Number	Conductors	Nominal Diameter		Jacket Thickness	
		Inch	mm	Inch	mm
5682	2	0.174	4.42	0.032	0.81
5683	3	0.180	4.57	0.032	0.81
5684	4	0.190	4.83	0.032	0.81
5685	6	0.214	5.44	0.032	0.81
5686	7	0.214	5.44	0.032	0.81
5687	8	0.226	5.74	0.032	0.81
5688	10	0.252	6.40	0.032	0.81
5689	15	0.276	7.01	0.032	0.81

24 AWG (0.23 mm²)

Stranding: 7/32 (7 x 0.20 mm)
 Insulation thickness: 0.010 (0.25 mm)

Part Number	Conductors	Nominal Diameter		Jacket Thickness	
		Inch	mm	Inch	mm
5112C	2	0.184	4.67	0.032	0.81
5113C	3	0.191	4.85	0.032	0.81
5114C	4	0.203	5.16	0.032	0.81
5116C	6	0.229	5.82	0.032	0.81
5118C	8	0.243	6.17	0.032	0.81
5120C	10	0.272	6.91	0.032	0.81
5120/15C	15	0.299	7.59	0.032	0.81
5120/20C	20	0.328	8.33	0.032	0.81
5120/25C	25	0.360	9.14	0.032	0.81
5120/30C	30	0.378	9.60	0.032	0.81
5120/40C	40	0.418	10.62	0.032	0.81
5120/50C	50	0.457	11.61	0.032	0.81





Xtra-Guard® 1

High Performance

300 V Supra-Shield® Foil/Braid, Multiconductor

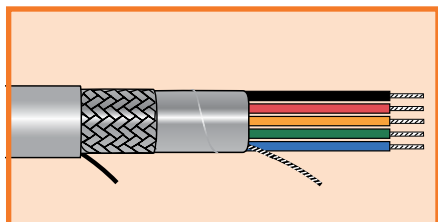

UL CM

UL AWM 2464 VW-1

CSA CMG FT4

Operating Temperature

- -30°C to +80°C (AWM)
- -30°C to +105°C (CM)

Conductor Color Coding

- 28, 26, 24, 22 AWG: Chart E (page 532)
- 20, 18, 16 AWG: Chart D (page 531)
- Jacket Colors
 - Put-ups: slate
 - Bulk: nine colors available (page 31, minimums may apply)

Materials

- Stranded tinned copper conductors
- Premium PVC insulation
- Supra-Shield foil + braid shield: Aluminum/polyester/aluminum foil with 25% overlap min. Tinned copper drain wire sized the same as conductors Tinned copper braid, 70% coverage min.
- Nylon ripcord
- Premium PVC jacket
- UV resistant

Availability

100 ft (30.5 m)

500 ft (152 m)

1000 ft (305 m)

Bulk, cut to length

FIT® Tubing Recommendations

- FIT-221: General-purpose, cross-linked polyolefin (indoor)
- FIT-321: Medium-wall, adhesive-lined, cross-linked polyolefin (outdoor)

22 AWG (0.35 mm²)

Stranding: 7/30 (7 x 0.25 mm)
Insulation thickness: 0.010 (0.25 mm)

Part Number	Conductors	Nominal Diameter		Jacket Thickness	
		Inch	mm	Inch	mm
5102C	2	0.196	4.98	0.032	0.81
5103C	3	0.204	5.18	0.032	0.81
5104C	4	0.217	5.51	0.032	0.81
5106C	6	0.247	6.27	0.032	0.81
5108C	8	0.263	6.68	0.032	0.81
5110C	10	0.296	7.52	0.032	0.81
5110/15C	15	0.327	8.31	0.032	0.81
5110/20C	20	0.359	9.12	0.032	0.81
5110/25C	25	0.396	10.06	0.032	0.81
5110/30C	30	0.417	10.59	0.032	0.81
5110/40C	40	0.462	11.73	0.032	0.81
5110/50C	50	0.506	12.85	0.032	0.81
5110/60C	60	0.588	14.94	0.053	1.35
5110/70C	70	0.630	16.00	0.053	1.35
5110/80C	80	0.665	16.89	0.053	1.35

20 AWG (0.56 mm²)

Stranding: 7/28 (7 x 0.32 mm)
Insulation thickness: 0.016 (0.41 mm)

Part Number	Conductors	Nominal Diameter		Jacket Thickness	
		Inch	mm	Inch	mm
5152C	2	0.236	5.99	0.032	0.81
5153C	3	0.247	6.27	0.032	0.81
5154C	4	0.266	6.76	0.032	0.81
5156C	6	0.308	7.82	0.032	0.81
5158C	8	0.330	8.38	0.032	0.81
5160C	10	0.376	9.55	0.032	0.81
5160/15C	15	0.419	10.64	0.032	0.81
5160/20C	20	0.465	11.81	0.032	0.81
5160/25C	25	0.516	13.11	0.032	0.81
5160/30C	30	0.545	13.84	0.032	0.81
5160/40C	40	0.656	16.66	0.053	1.35
5160/50C	50	0.718	18.24	0.053	1.35
5160/60C	60	0.774	19.66	0.053	1.35





Xtra-Guard® 1

High Performance

300 V Supra-Shield® Foil/Braid, Multiconductor

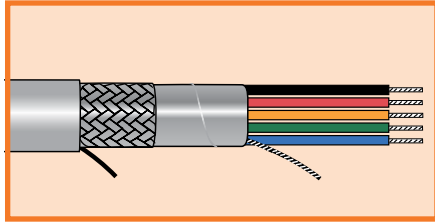

UL CM

UL AWM 2464 VW-1

CSA CMG FT4

Operating Temperature

- -30°C to +80°C (AWM)
- -30°C to +105°C (CM)

Conductor Color Coding

- 28, 26, 24, 22 AWG: Chart E (page 532)
- 20, 18, 16 AWG: Chart D (page 531)
- Jacket Colors
 - Put-ups: slate
 - Bulk: nine colors available (page 31, minimums may apply)

Materials

- Stranded tinned copper conductors
- Premium PVC insulation
- Supra-Shield foil + braid shield: Aluminum/polyester/aluminum foil with 25% overlap min. Tinned copper drain wire sized the same as conductors
- Tinned copper braid, 70% coverage min.
- Nylon ripcord
- Premium PVC jacket
- UV resistant

Availability

100 ft (30.5 m)
 500 ft (152 m)
 1000 ft (305 m)
 Bulk, cut to length

FIT® Tubing Recommendations

- FIT-221: General-purpose, cross-linked polyolefin (indoor)
- FIT-321: Medium-wall, adhesive-lined, cross-linked polyolefin (outdoor)

18 AWG (0.81 mm²)

Stranding: 16/30 (16 x 0.25 mm)
 Insulation thickness: 0.016 (0.41 mm)

Part Number	Conductors	Nominal Diameter		Jacket Thickness	
		Inch	mm	Inch	mm
5162/1C*	2	0.254	6.45	0.032	0.81
5162C	2	0.254	6.45	0.032	0.81
5163/1C*	3	0.266	6.76	0.032	0.81
5163C	3	0.266	6.76	0.032	0.81
5164C	4	0.287	7.29	0.032	0.81
5166C	6	0.335	8.51	0.032	0.81
5168C	8	0.360	9.14	0.032	0.81
5170C	10	0.412	10.46	0.032	0.81
5170/15C	15	0.461	11.71	0.032	0.81
5170/20C	20	0.512	13.00	0.032	0.81
5170/25C	25	0.612	15.54	0.053	1.35
5170/30C	30	0.651	16.54	0.053	1.35
5170/40C	40	0.722	18.34	0.053	1.35

*Conductors color-coded per international standards: brown, blue, green/yellow.

16 AWG (1.23 mm²)

Stranding: 19/0.0117 (19 x 0.29 mm)
 Insulation thickness: 0.016 (0.41 mm)

Part Number	Conductors	Nominal Diameter		Jacket Thickness	
		Inch	mm	Inch	mm
5172/1C*	2	0.278	7.06	0.032	0.81
5172C	2	0.278	7.06	0.032	0.81
5173/1C*	3	0.292	7.42	0.032	0.81
5173C	3	0.292	7.42	0.032	0.81
5174C	4	0.316	8.03	0.032	0.81
5176C	6	0.371	9.42	0.032	0.81
5178C	8	0.400	10.16	0.032	0.81
5180C	10	0.460	11.68	0.032	0.81
5180/15C	15	0.516	13.11	0.032	0.81
5180/20C	20	0.617	15.67	0.053	1.35
5180/25C	25	0.690	17.53	0.053	1.35

*Conductors color-coded per international standards: brown, blue, green/yellow.





Xtra-Guard® 1

High Performance

300 V Supra-Shield® Foil/Braid, Multiconductor

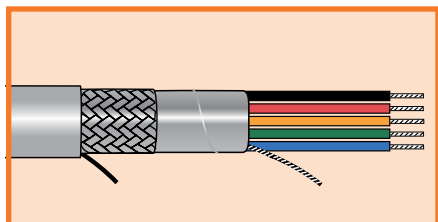

UL CM

UL AWM 2343 VW-1

CSA CMG FT4

Operating Temperature

- -30°C to +80°C (AWM)
- -30°C to +105°C (CM)

Conductor Color Coding

- Chart E (page 532)
- Jacket Colors
 - Put-ups: slate
 - Bulk: nine colors available (page 31, minimums may apply)

Materials

- Stranded tinned copper conductors
- Premium PVC insulation
- Supra-Shield foil + braid shield: Aluminum/polyester/aluminum foil with 25% overlap min. Tinned copper drain wire sized the same as conductors Tinned copper braid, 70% coverage min.
- Nylon ripcord
- Premium PVC jacket
- UV resistant

Availability

100 ft (30.5 m)

500 ft (152 m)

1000 ft (305 m)

Bulk, cut to length

FIT® Tubing Recommendations

- FIT-221: General-purpose, cross-linked polyolefin (indoor)
- FIT-321: Medium-wall, adhesive-lined, cross-linked polyolefin (outdoor)



24 AWG (0.23 mm²)

Stranding: 7/32 (7 x 0.20 mm)
Insulation thickness: 0.010 (0.25 mm)

Part Number	Conductors	Nominal Diameter		Jacket Thickness	
		Inch	mm	Inch	mm
5300C	5	0.278	7.06	0.063	1.60
5301C	7	0.291	7.39	0.063	1.60
5302C	12	0.341	8.66	0.063	1.60
5303C	15	0.361	9.17	0.063	1.60
5304C	19	0.378	9.60	0.063	1.60
5305C	27	0.429	10.90	0.063	1.60
5306C	37	0.466	11.84	0.063	1.60
5307C	48	0.517	13.13	0.063	1.60

22 AWG (0.35 mm²)

Stranding: 7/30 (7 x 0.25 mm)
Insulation thickness: 0.010 (0.25 mm)

Part Number	Conductors	Nominal Diameter		Jacket Thickness	
		Inch	mm	Inch	mm
5310C	5	0.294	7.47	0.063	1.60
5311C	7	0.309	7.85	0.063	1.60
5312C	12	0.366	9.30	0.063	1.60
5313C	15	0.389	9.88	0.063	1.60
5314C	19	0.408	10.36	0.063	1.60
5316C	37	0.508	12.90	0.063	1.60
5318C	60	0.608	15.44	0.063	1.60

20 AWG (0.56 mm²)

Stranding: 7/28 (7 x 0.32 mm)
Insulation thickness: 0.010 (0.25 mm)

Part Number	Conductors	Nominal Diameter		Jacket Thickness	
		Inch	mm	Inch	Mm
5320/4C	4	0.299	7.59	0.063	1.60
5320C	5	0.316	8.03	0.063	1.60
5321C	7	0.333	8.46	0.063	1.60
5322C	12	0.399	10.13	0.063	1.60
5323C	15	0.426	10.82	0.063	1.60
5324C	19	0.448	11.38	0.063	1.60
5325C	27	0.515	13.08	0.063	1.60
5326C	37	0.564	14.33	0.063	1.60



Xtra-Guard® 1

High Performance 600 V Supra-Shield® Foil/Braid, Multiconductor

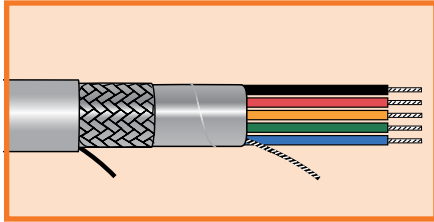

UL AWM 2501 VW-1
CSA AWM I/II A/B FT4
UL MTW

Operating Temperature

- -30°C to +105°C (AWM)
- -30°C to +90°C (MTW)

Conductor Color Coding

- Chart E (page 532)
- Jacket Colors
 - Put-ups: slate
 - Bulk: nine colors available (page 31, minimums may apply)

Materials

- Stranded tinned copper conductors
- Premium PVC insulation
- Supra-Shield foil + braid shield: Aluminum/polyester/aluminum foil with 25% overlap min. Tinned copper drain wire sized the same as conductors Tinned copper braid, 70% coverage min.
- Nylon ripcord
- Premium PVC jacket
- UV resistant

Availability

100 ft (30.5 m)
500 ft (152 m)
1000 ft (305 m)
Bulk, cut to length

FIT® Tubing Recommendations

- FIT-221: General-purpose, cross-linked polyolefin (indoor)
- FIT-321: Medium-wall, adhesive-lined, cross-linked polyolefin (outdoor)

22 AWG (0.35 mm²)

Stranding: 7/30 (7 x 0.25 mm)
Insulation thickness: 0.032 (0.81 mm)

Part Number	Conductors	Nominal Diameter		Jacket Thickness	
		Inch	mm	Inch	mm
5504	4	0.386	9.80	0.063	1.60
5507	7	0.442	11.23	0.063	1.60
5509/12	12	0.549	13.94	0.063	1.60

20 AWG (0.56 mm²)

Stranding: 10/30 (10 x 0.25 mm)
Insulation thickness: 0.032 (0.81 mm)

Part Number	Conductors	Nominal Diameter		Jacket Thickness	
		Inch	mm	Inch	mm
5514	4	0.405	10.29	0.063	1.60
5517	7	0.466	11.84	0.063	1.60
5519	9	0.531	13.49	0.063	1.60
5519/12	12	0.582	14.78	0.063	1.60
5519/19	19	0.675	17.15	0.063	1.60

18 AWG (0.81 mm²)

Stranding: 16/30 (16 x 0.25 mm)
Insulation thickness: 0.032 (0.81 mm)

Part Number	Conductors	Nominal Diameter		Jacket Thickness	
		Inch	mm	Inch	mm
5522	2	0.380	9.65	0.063	1.60
5523	3	0.397	10.08	0.063	1.60
5524	4	0.427	10.85	0.063	1.60
5525	5	0.460	11.68	0.063	1.60
5527	7	0.494	12.55	0.063	1.60
5529	9	0.563	14.30	0.063	1.60
5529/12	12	0.619	15.72	0.063	1.60
5529/15	15	0.677	17.20	0.063	1.60
5529/19	19	0.760	19.30	0.083	2.11





Xtra-Guard® 1

High Performance

600 V Supra-Shield® Foil/Braid, Multiconductor

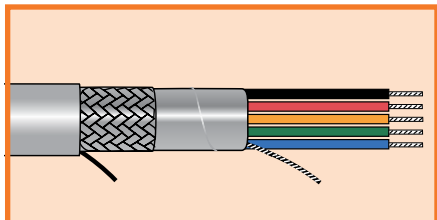

UL AWM 2501 VW-1
CSA AWM I/II A/B FT4
UL MTW

Operating Temperature

- -30°C to +105°C (AWM)
- -30°C to +90°C (MTW)

Conductor Color Coding

- Chart E (page 532)
- Jacket Colors
 - Put-ups: slate
 - Bulk: nine colors available (page 31, minimums may apply)

Materials

- Stranded tinned copper conductors
- Premium PVC insulation
- Supra-Shield foil + braid shield: Aluminum/polyester/aluminum foil with 25% overlap min. Tinned copper drain wire sized the same as conductors Tinned copper braid, 70% coverage min.
- Nylon ripcord
- Premium PVC jacket
- UV resistant

Availability

100 ft (30.5 m)
 500 ft (152 m)
 1000 ft (305 m)
 Bulk, cut to length

FIT® Tubing Recommendations

- FIT-221: General-purpose, cross-linked polyolefin (indoor)
- FIT-321: Medium-wall, adhesive-lined, cross-linked polyolefin (outdoor)

16 AWG (1.23 mm²)

Stranding: 19/0.0117 (19 x 0.29 mm)
 Insulation thickness: 0.032 (0.81 mm)

Part Number	Conductors	Nominal Diameter		Jacket Thickness	
		Inch	mm	Inch	mm
5532	2	0.404	10.26	0.063	1.60
5533	3	0.423	10.74	0.063	1.60
5534	4	0.456	11.58	0.063	1.60
5535	5	0.492	12.50	0.063	1.60
5537	7	0.530	13.46	0.063	1.60
5539	9	0.607	15.42	0.063	1.60
5539/12	12	0.675	17.15	0.063	1.60
5539/15	15	0.772	19.61	0.063	1.60
5539/19	19	0.820	20.83	0.083	2.11

14 AWG (2.08 mm²)

Stranding: 41/30 (41 x 0.25 mm)
 Insulation thickness: 0.032 (0.81 mm)

Part Number	Conductors	Nominal Diameter		Jacket Thickness	
		Inch	mm	Inch	mm
5542	2	0.434	11.02	0.063	1.60
5543	3	0.456	11.58	0.063	1.60
5544	4	0.492	12.50	0.063	1.60
5547	7	0.575	14.61	0.063	1.60
5549	9	0.668	16.97	0.063	1.60
5549/12	12	0.777	19.74	0.083	2.11
5549/15	15	0.841	21.36	0.083	2.11





Xtra-Guard® 1

High Performance 300 V Unshielded, Multipair

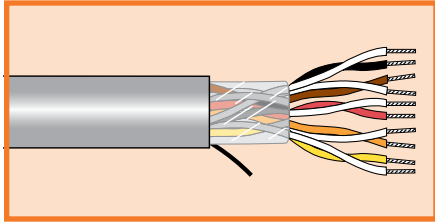

UL CM
UL AWM 2464 VW-1
CSA CMG FT4

Operating Temperature

- -30°C to +80°C (AWM)
- -30°C to +105°C (CM)

Conductor Color Coding

- 24, 22 AWG: Chart B (page 528)
- 20, 18 AWG: Chart A (page 528)
- Jacket Colors
 - Put-ups: slate
 - Bulk: nine colors available (page 31, minimums may apply)

Materials

- Stranded tinned copper conductors
- Premium PVC insulation
- Nylon ripcord
- Premium PVC jacket
- UV resistant

Availability

100 ft (30.5 m)
500 ft (152 m)
1000 ft (305 m)
Bulk, cut to length

FIT® Tubing Recommendations

- FIT-221: General-purpose, cross-linked polyolefin (indoor)
- FIT-321: Medium-wall, adhesive-lined, cross-linked polyolefin (outdoor)

24 AWG (0.23 mm²)

Stranding: 7/32 (7 x 0.20 mm)
Insulation thickness: 0.010 (0.25 mm)

Part No.	Pairs	Nominal Diameter		Jacket Thickness	
		Inch	mm	Inch	mm
5261C	1	0.156	3.96	0.032	0.81
5262C	2	0.212	5.38	0.032	0.81
5263C	3	0.224	5.69	0.032	0.81
5264C	4	0.243	6.17	0.032	0.81
5265C	5	0.264	6.71	0.032	0.81
5266C	6	0.286	7.26	0.032	0.81
5269C	9	0.332	8.43	0.032	0.81
5269/11C	11	0.357	9.07	0.032	0.81
5269/15C	15	0.401	10.19	0.032	0.81
5269/27C	27	0.512	13.00	0.032	0.81
5269/77C	77	0.904	22.96	0.083	0.81

22 AWG (0.35 mm²)

Stranding: 7/30 (7 x 0.25 mm)
Insulation thickness: 0.010 (0.25 mm)

Part No.	Pairs	Nominal Diameter		Jacket Thickness	
		Inch	mm	Inch	mm
5021C	1	0.168	4.27	0.032	0.81
5022C	2	0.232	5.89	0.032	0.81
5023C	3	0.245	6.22	0.032	0.81
5024C	4	0.267	6.78	0.032	0.81
5025C	5	0.291	7.39	0.032	0.81
5026C	6	0.316	8.03	0.032	0.81
5029/15C	15	0.447	11.35	0.032	0.81





Xtra-Guard® 1

High Performance
300 V Unshielded, Multipair

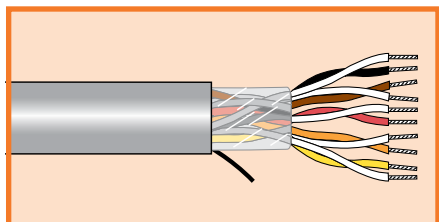

UL CM
UL AWM 2464 VW-1
CSA CMG FT4

Operating Temperature

- -30°C to +80°C (AWM)
- -30°C to +105°C (CM)

Conductor Color Coding

- 24, 22 AWG: Chart B (page 528)
- 20, 18 AWG: Chart A (page 528)
- Jacket Colors
 - Put-ups: slate
 - Bulk: nine colors available (page 31, minimums may apply)

Materials

- Stranded tinned copper conductors
- Premium PVC insulation
- Nylon ripcord
- Premium PVC jacket
- UV resistant

Availability

100 ft (30.5 m)
500 ft (152 m)
1000 ft (305 m)
Bulk, cut to length

FIT® Tubing Recommendations

- FIT-221: General-purpose, cross-linked polyolefin (indoor)
- FIT-321: Medium-wall, adhesive-lined, cross-linked polyolefin (outdoor)

20 AWG (0.56 mm²)

Stranding: 7/28 (7 x 0.32 mm)
Insulation thickness: 0.016 (0.41 mm)

Part No.	Pairs	Nominal Diameter		Jacket Thickness	
		Inch	mm	Inch	mm
5282C	2	0.298	7.57	0.032	0.81
5283C	3	0.316	8.03	0.032	0.81
5286C	6	0.415	10.54	0.032	0.81
5289C	9	0.487	12.37	0.032	0.81
5289/12C	12	0.545	13.84	0.032	0.81

18 AWG (0.81 mm²)

Stranding: 16/30 (16 x 0.25 mm)
Insulation thickness: 0.016 (0.41 mm)

Part No.	Pairs	Nominal Diameter		Jacket Thickness	
		Inch	mm	Inch	mm
5032C	2	0.327	8.31	0.032	0.81
5033C	3	0.348	8.84	0.032	0.81
5036C	6	0.460	11.68	0.032	0.81
5039C	9	0.541	13.74	0.053	1.35
5039/12C	12	0.648	16.46	0.053	1.35





Xtra-Guard® 1

High Performance
300 V Foil Shield, Multipair

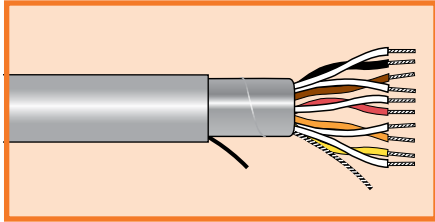

UL CM
UL AWM 2464 VW-1
CSA CMG FT4

Operating Temperature

- -30°C to +80°C (AWM)
- -30°C to +105°C (CM)

Conductor Color Coding

- 28, 26, 24, 22 AWG: Chart B (page 528)
- 20, 18 AWG: Chart A (page 528)
- Jacket Colors
 - Put-ups: slate
 - Bulk: nine colors available (page 31, minimums may apply)

Materials

- Stranded tinned copper conductors
- Premium PVC insulation
- Aluminum/polyester foil shield, with 25% overlap and foil facing inward
- Tinned copper drain wire sized the same as cable conductors
- Nylon ripcord
- Premium PVC jacket
- UV resistant

Availability

100 ft (30.5 m)
500 ft (152 m)
1000 ft (305 m)
Bulk, cut to length

FIT® Tubing Recommendations

- FIT-221: General-purpose, cross-linked polyolefin (indoor)
- FIT-321: Medium-wall, adhesive-lined, cross-linked polyolefin (outdoor)

28 AWG (0.09 mm²)

Stranding: 7/36 (7 x 0.12 mm)
Insulation Thickness: 0.010 (0.25 mm)

Part No.	Pairs	Nominal Diameter		Jacket Thickness	
		Inch	mm	Inch	mm
5938	2	0.187	4.75	0.032	0.81
5939	3	0.196	4.98	0.032	0.81
5940	4	0.211	5.36	0.032	0.81
5941	5	0.228	5.79	0.032	0.81
5942	6	0.246	6.25	0.032	0.81

26 AWG (0.14 mm²)

Stranding: 7/34 (7 x 0.16 mm)
Insulation thickness: 0.010 (0.25 mm)

Part No.	Pairs	Nominal Diameter		Jacket Thickness	
		Inch	mm	Inch	mm
5690	2	0.200	5.08	0.032	0.81
5691	3	0.210	5.33	0.032	0.81
5692	4	0.227	5.77	0.032	0.81
5693	5	0.246	6.25	0.032	0.81
5694	6	0.265	6.73	0.032	0.81

24 AWG (0.23 mm²)

Stranding: 7/32 (7 x 0.20 mm)
Insulation thickness: 0.010 (0.25 mm)

Part No.	Pairs	Nominal Diameter		Jacket Thickness	
		Inch	mm	Inch	mm
5491C	1	0.160	4.06	0.032	0.81
5492C	2	0.216	5.49	0.032	0.81
5493C	3	0.228	5.79	0.032	0.81
5494C	4	0.247	6.27	0.032	0.81
5495C	5	0.268	6.81	0.032	0.81
5496C	6	0.290	7.37	0.032	0.81
5499C	9	0.336	8.53	0.032	0.81
5499/11C	11	0.361	9.17	0.032	0.81
5499/15C	15	0.405	10.29	0.032	0.81
5499/19C	19	0.433	11.00	0.032	0.81
5499/27C	27	0.516	13.11	0.32	0.81





Xtra-Guard® 1

High Performance
300 V Foil Shield, Multipair

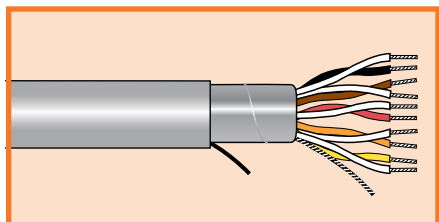

UL CM
UL AWM 2464 VW-1
CSA CMG FT4

Operating Temperature

- -30°C to +80°C (AWM)
- -30°C to +105°C (CM)

Conductor Color Coding

- 28, 26, 24, 22 AWG: Chart B (page 528)
- 20, 18 AWG: Chart A (page 528)
- Jacket Colors
 - Put-ups: slate
 - Bulk: nine colors available (page 31, minimums may apply)

Materials

- Stranded tinned copper conductors
- Premium PVC insulation
- Aluminum/polyester foil shield, with 25% overlap and foil facing inward
- Tinned copper drain wire sized the same as cable conductors
- Nylon ripcord
- Premium PVC jacket
- UV resistant

Availability

100 ft (30.5 m)
500 ft (152 m)
1000 ft (305 m)
Bulk, cut to length

FIT® Tubing Recommendations

- FIT-221: General-purpose, cross-linked polyolefin (indoor)
- FIT-321: Medium-wall, adhesive-lined, cross-linked polyolefin (outdoor)

22 AWG (0.35 mm ²)					
Stranding: 7/30 (7 x 0.25 mm) Insulation thickness: 0.010 (0.25 mm)					
Part No.	Pairs	Nominal Diameter		Jacket Thickness	
		Inch	mm	Inch	mm
5481C	1	0.172	4.37	0.032	0.81
5482C	2	0.236	5.99	0.032	0.81
5483C	3	0.249	6.32	0.032	0.81
5484C	4	0.271	6.88	0.032	0.81
5485C	5	0.295	7.49	0.032	0.81
5486C	6	0.320	8.13	0.032	0.81
5489C	9	0.372	9.45	0.032	0.81
5489/11C	11	0.400	10.16	0.032	0.81
5489/15C	15	0.451	11.46	0.032	0.81
5489/19C	19	0.483	12.27	0.032	0.81
5489/27C	27	0.619	15.72	0.053	1.35

20 AWG (0.56 mm ²)					
Stranding: 7/28 (7 x 0.32 mm) Insulation thickness: 0.016 (0.41 mm)					
Part No.	Pairs	Nominal Diameter		Jacket Thickness	
		Inch	mm	Inch	mm
5452C	2	0.302	7.67	0.032	0.81
5453C	3	0.320	8.13	0.032	0.81
5456C	6	0.419	10.64	0.032	0.81
5459C	9	0.491	12.47	0.032	0.81
5459/12C	12	0.549	13.94	0.032	0.81
5459/19C	19	0.689	17.50	0.053	1.35

18 AWG (0.81 mm ²)					
Stranding: 16/30 (16 x 0.25 mm) Insulation thickness: 0.016 (0.41 mm)					
Part No.	Pairs	Nominal Diameter		Jacket Thickness	
		Inch	mm	Inch	mm
5373C	3	0.352	8.94	0.032	0.81
5376C	6	0.464	11.79	0.032	0.81





Xtra-Guard® 1

High Performance 300 V Supra-Shield® Foil/Braid, Multipair

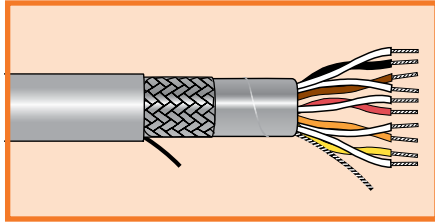

UL CM
UL AWM 2464 VW-1
CSA CMG FT4

Operating Temperature

- -30°C to +80°C (AWM)
- -30°C to +105°C (CM)

Conductor Color Coding

- 28, 26, 24, 22 AWG: Chart B (page 528)
- 20, 18 AWG: Chart A (page 528)
- Jacket Colors
 - Put-ups: slate
 - Bulk: nine colors available (page 31, minimums may apply)

Materials

- Stranded tinned copper conductors
- Premium PVC insulation
- Supra-Shield foil + braid shield: Aluminum/polyester/aluminum foil with 25% overlap min. Tinned copper drain wire sized the same as conductors Tinned copper braid, 70% coverage min.
- Nylon ripcord
- Premium PVC jacket
- UV resistant

Availability

100 ft (30.5 m)
500 ft (152 m)
1000 ft (305 m)
Bulk, cut to length

FIT® Tubing Recommendations

- FIT-221: General-purpose, cross-linked polyolefin (indoor)
- FIT-321: Medium-wall, adhesive-lined, cross-linked polyolefin (outdoor)

28 AWG (0.09 mm²)

Stranding: 7/36 (7 x 0.12 mm)
Insulation Thickness: 0.010 (0.25 mm)

Part No.	Pairs	Nominal Diameter		Jacket Thickness	
		Inch	mm	Inch	mm
5943	2	0.211	5.36	0.032	0.81
5944	3	0.220	5.59	0.032	0.81
5945	4	0.235	5.97	0.032	0.81
5946	5	0.252	6.40	0.032	0.81
5947	6	0.270	6.86	0.032	0.81

26 AWG (0.14 mm²)

Stranding: 7/34 (7 x 0.16 mm)
Insulation thickness: 0.010 (0.25 mm)

Part No.	Pairs	Nominal Diameter		Jacket Thickness	
		Inch	mm	Inch	mm
5695	2	0.224	5.69	0.032	0.81
5696	3	0.234	5.94	0.032	0.81
5697	4	0.251	6.38	0.032	0.81
5698	5	0.270	6.86	0.032	0.81
5699	6	0.289	7.34	0.032	0.81

24 AWG (0.23 mm²)

Stranding: 7/32 (7 x 0.20 mm)
Insulation thickness: 0.010 (0.25 mm)

Part No.	Pairs	Nominal Diameter		Jacket Thickness	
		Inch	mm	Inch	mm
5271C	1	0.184	4.67	0.032	0.81
5272C	2	0.240	6.10	0.032	0.81
5273C	3	0.252	6.40	0.032	0.81
5274C	4	0.271	6.88	0.032	0.81
5275C	5	0.292	7.42	0.032	0.81
5276C	6	0.314	7.98	0.032	0.81
5279C	9	0.360	9.14	0.032	0.81
5279/11C	11	0.385	9.78	0.032	0.81
5279/15C	15	0.429	10.90	0.032	0.81
5279/19C	19	0.457	11.61	0.032	0.81
5279/27C	27	0.540	13.72	0.032	0.81
5279/51C	51	0.739	18.77	0.053	1.35





Xtra-Guard® 1

High Performance 300 V Supra-Shield® Foil/Braid, Multipair

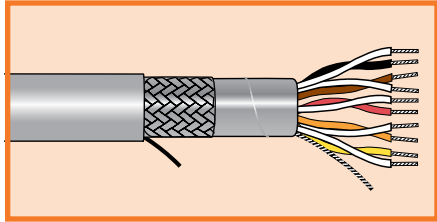

UL CM
UL AWM 2464 VW-1
CSA CMG FT4

Operating Temperature

- -30°C to +80°C (AWM)
- -30°C to +105°C (CM)

Conductor Color Coding

- 28, 26, 24, 22 AWG: Chart B (page 528)
- 20, 18 AWG: Chart A (page 528)
- Jacket Colors
 - Put-ups: slate
 - Bulk: nine colors available (page 31, minimums may apply)

Materials

- Stranded tinned copper conductors
- Premium PVC insulation
- Supra-Shield foil + braid shield: Aluminum/polyester/aluminum foil with 25% overlap min. Tinned copper drain wire sized the same as conductors Tinned copper braid, 70% coverage min.
- Nylon ripcord
- Premium PVC jacket
- UV resistant

Availability

100 ft (30.5 m)
500 ft (152 m)
1000 ft (305 m)
Bulk, cut to length

FIT® Tubing Recommendations

- FIT-221: General-purpose, cross-linked polyolefin (indoor)
- FIT-321: Medium-wall, adhesive-lined, cross-linked polyolefin (outdoor)

22 AWG (0.35 mm²)

Stranding: 7/30 (7 x 0.25 mm)
Insulation thickness: 0.010 (0.25 mm)

Part No.	Pairs	Nominal Diameter		Jacket Thickness	
		Inch	mm	Inch	mm
5121C	1	0.196	4.98	0.032	0.81
5122C	2	0.260	6.60	0.032	0.81
5123C	3	0.273	6.93	0.032	0.81
5124C	4	0.295	7.49	0.032	0.81
5125C	5	0.319	8.10	0.032	0.81
5126C	6	0.344	8.74	0.032	0.81
5129C	9	0.396	10.06	0.032	0.81
5129/11C	11	0.424	10.77	0.032	0.81
5129/15C	15	0.475	12.07	0.032	0.81
5129/19C	19	0.507	12.88	0.032	0.81
5129/27C	27	0.649	16.48	0.053	1.35

20 AWG (0.56 mm²)

Stranding: 7/28 (7 x 0.32 mm)
Insulation thickness: 0.016 (0.41 mm)

Part No.	Pairs	Nominal Diameter		Jacket Thickness	
		Inch	mm	Inch	mm
5292C	2	0.326	8.28	0.032	0.81
5293C	3	0.344	8.74	0.032	0.81
5296C	6	0.443	11.25	0.032	0.81
5299C	9	0.515	13.08	0.032	0.81
5299/19C	19	0.719	18.26	0.053	1.35

18 AWG (0.81 mm²)

Stranding: 16/30 (16 x 0.25 mm)
Insulation thickness: 0.016 (0.41 mm)

Part No.	Pairs	Nominal Diameter		Jacket Thickness	
		Inch	mm	Inch	mm
5132C	2	0.355	9.02	0.032	0.81
5133C	3	0.376	9.55	0.032	0.81
5136C	6	0.488	12.40	0.032	0.81
5139C	9	0.611	15.52	0.053	1.35
5139/27C	27	1.004	25.50	0.083	2.11





Xtra-Guard® 1

High Performance 300 V Supra-Shield® Foil/Braid, Multipair

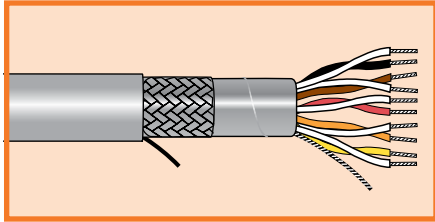

UL CM
UL AWM 2343 VW-1
CSA CMG FT4

Operating Temperature

- -30°C to +80°C (AWM)
- -30°C to +105°C (CM)

Conductor Color Coding

- Chart B (page 528)
- Jacket Colors
 - Put-ups: slate
 - Bulk: nine colors available (page 31, minimums may apply)

Materials

- Stranded tinned copper conductors
- Premium PVC insulation
- Supra-Shield foil + braid shield: Aluminum/polyester/aluminum foil with 25% overlap min. Tinned copper drain wire sized the same as conductors Tinned copper braid, 70% coverage min.
- Nylon ripcord
- Premium PVC jacket
- UV resistant

Availability

100 ft (30.5 m)
500 ft (152 m)
1000 ft (305 m)
Bulk, cut to length

FIT® Tubing Recommendations

- FIT-221: General-purpose, cross-linked polyolefin (indoor)
- FIT-321: Medium-wall, adhesive-lined, cross-linked polyolefin (outdoor)



24 AWG (0.23 mm²)

Stranding: 7/32 (7 x 0.20 mm)
Insulation thickness: 0.010 (0.25 mm)

Part No.	Pairs	Nominal Diameter		Jacket Thickness	
		Inch	mm	Inch	mm
5330C	5	0.354	8.99	0.063	1.60
5331C	7	0.376	9.55	0.063	1.60
5332C	12	0.458	11.63	0.063	1.60
5333C	15	0.491	12.47	0.063	1.60
5334C	19	0.519	13.18	0.063	1.60
5335C	27	0.602	15.29	0.063	1.60
5336C	37	0.669	16.99	0.063	1.60

22 AWG (0.35 mm²)

Stranding: 7/30 (7 x 0.25 mm)
Insulation thickness: 0.010 (0.25 mm)

Part No.	Pairs	Nominal Diameter		Jacket Thickness	
		Inch	mm	Inch	mm
5340/2C	2	0.322	8.18	0.063	1.60
5340C	5	0.381	9.68	0.063	1.60
5341C	7	0.406	10.31	0.063	1.60
5342C	12	0.499	12.67	0.063	1.60
5344C	19	0.569	14.45	0.063	1.60
5345C	27	0.669	16.99	0.063	1.60
5346C	37	0.738	18.75	0.063	1.60

20 AWG (0.56 mm²)

Stranding: 7/28 (7 x 0.32 mm)
Insulation thickness: 0.010 (0.25 mm)

Part No.	Pairs	Nominal Diameter		Jacket Thickness	
		Inch	mm	Inch	mm
5350/4C	4	0.388	9.86	0.063	1.60
5350C	5	0.416	10.57	0.063	1.60
5351C	7	0.446	11.33	0.063	1.60
5351/9C	9	0.505	12.83	0.063	1.60
5353C	15	0.597	15.16	0.063	1.60
5354C	19	0.634	16.10	0.063	1.60
5355C	27	0.749	19.02	0.063	1.60

Xtra-Guard® 2

Oil and Abrasion Resistant

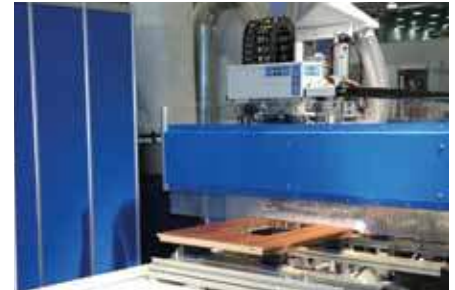

Features

- Fast, easy stripping of insulation and jacket
- Color-coded, tinned copper conductors
- Specially formulated, rugged polyurethane jacket offering three times the tear and abrasion resistance of ordinary PVC
- Resistance to cut-through and physical damage
- 300 V and 600 V
- Unshielded, foil shielded, or Supra-Shield® foil/braid
- Temperature ratings to 90°C (300 V) and 105°C (600 V)
- Superior low-temperature flexibility to -30°C
- Outstanding ultraviolet light stability in all jacket colors
- UL VW-1 and CSA FT-1 flammability ratings
- Nylon ripcord for easy jacket stripping

Applications

- CNC machine centers
- Automotive assembly plant operations
- Military ground support systems
- Packaging machinery
- Petrochemical plant operations
- Geophysical exploration equipment

FIT® Tubing Recommendations

- FIT-750: Bonding adhesive lined, cross-linked polyolefin

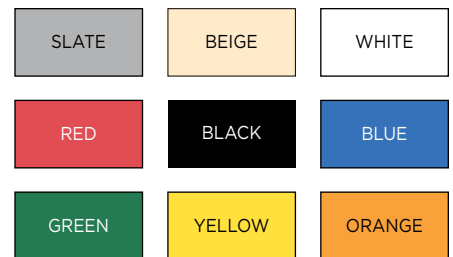

Xtra-Guard cables are available in a range of long-lasting colors for fast, easy identification, for safety reasons, and for matching the color of your system.

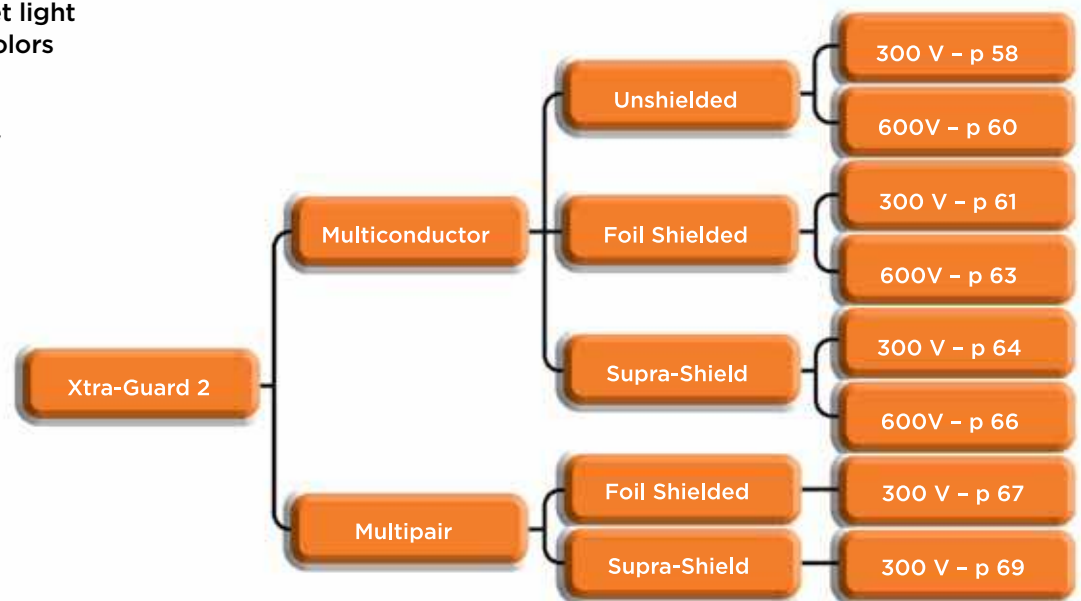



Xtra-Guard® 2

Oil and Abrasion Resistant 300 V Unshielded, Multiconductor

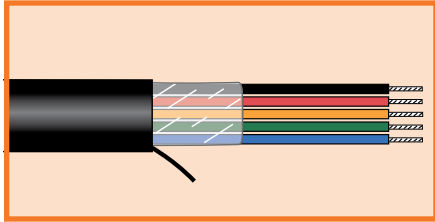

UL AWM 20668 VW-1
CSA AWM I/II A/B FT1

Operating Temperature

- -30°C to +90°C

Conductor Color Coding

- 24, 22 AWG: Chart E (page 532)
- 20, 18, 16 AWG: Chart D (page 531)
- Nine jacket colors (black standard)
- Custom colors available

Materials

- Stranded tinned copper conductors
- Premium PVC insulation
- Specially formulated polyurethane jacket
- UV resistant
- Nylon ripcord

Availability

Made to order
1000 ft (305 m) minimum

FIT® Tubing Recommendations

- FIT-750: Bonding adhesive lined, cross-linked polyolefin

24 AWG (0.23 mm²)

Stranding: 7/32 (7 x 0.20 mm)
Insulation thickness: 0.010 (0.25 mm)

Part No.	Conductors	Nominal Diameter		Jacket Thickness	
		Inch	mm	Inch	mm
25012	2	0.156	3.96	0.032	0.81
25013	3	0.163	4.14	0.032	0.81
25014	4	0.175	4.45	0.032	0.81
25016	6	0.201	5.11	0.032	0.81
25018	8	0.215	5.46	0.032	0.81
25020	10	0.244	6.20	0.032	0.81
25020/15	15	0.271	6.88	0.032	0.81
25020/20	20	0.300	7.62	0.032	0.81
25020/25	25	0.332	8.43	0.032	0.81

22 AWG (0.35 mm²)

Stranding: 7/30 (7 x 0.25 mm)
Insulation thickness: 0.010 (0.25 mm)

Part No.	Conductors	Nominal Diameter		Jacket Thickness	
		Inch	mm	Inch	mm
25002	2	0.168	4.27	0.032	0.81
25003	3	0.176	4.47	0.032	0.81
25004	4	0.189	4.80	0.032	0.81
25006	6	0.219	5.56	0.032	0.81
25008	8	0.235	5.97	0.032	0.81
25010	10	0.268	6.81	0.032	0.81
25010/15	15	0.299	7.59	0.032	0.81
25010/20	20	0.331	8.41	0.032	0.81
25010/25	25	0.368	9.35	0.032	0.81

20 AWG (0.56 mm²)

Stranding: 7/28 (7 x 0.32 mm)
Insulation thickness: 0.016 (0.41 mm)

Part No.	Conductors	Nominal Diameter		Jacket Thickness	
		Inch	mm	Inch	mm
25052	2	0.208	5.28	0.032	0.81
25053	3	0.219	5.56	0.032	0.81
25054	4	0.238	6.05	0.032	0.81
25056	6	0.280	7.11	0.032	0.81
25058	8	0.302	7.67	0.032	0.81
25060	10	0.348	8.84	0.032	0.81
25060/15	15	0.391	9.93	0.032	0.81
25060/20	20	0.437	11.10	0.032	0.81
25060/25	25	0.488	12.40	0.032	0.81
25060/30	30	0.517	13.13	0.032	0.81
25060/40	40	0.622	15.80	0.053	1.35
25060/50	50	0.684	17.37	0.053	1.35
25060/60	60	0.740	18.80	0.053	1.35
25060/70	70	0.859	21.82	0.053	1.35





Xtra-Guard® 2

Oil and Abrasion Resistant 300 V Unshielded, Multiconductor

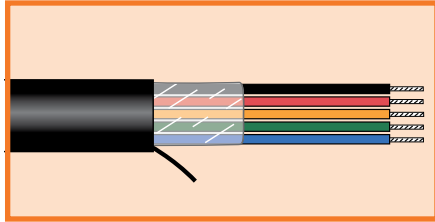

**UL AWM 20668 VW-1
CSA AWM I/II A/B FT1**

Operating Temperature

- -30°C to +90°C

Conductor Color Coding

- 24, 22 AWG: Chart E (page 532)
- 20, 18, 16 AWG: Chart D (page 531)
- Nine jacket colors (black standard)
- Custom colors available

Materials

- Stranded tinned copper conductors
- Premium PVC insulation
- Specially formulated polyurethane jacket
- UV resistant
- Nylon ripcord

Availability

Made to order
1000 ft (305 m) minimum

FIT® Tubing Recommendations

- FIT-750: Bonding adhesive lined, cross-linked polyolefin

18 AWG (0.81 mm²)

Stranding: 16/30 (16 x 0.25 mm)
Insulation thickness: 0.016 (0.41 mm)

Part No.	Conductors	Nominal Diameter		Jacket Thickness	
		Inch	mm	Inch	mm
25062	2	0.226	5.74	0.032	0.81
25062/1*	2	0.226	5.74	0.032	0.81
25063	3	0.238	6.05	0.032	0.81
25063/1*	3	0.238	6.05	0.032	0.81
25064	4	0.259	6.58	0.032	0.81
25066	6	0.307	7.80	0.032	0.81
25068	8	0.332	8.43	0.032	0.81
25070	10	0.384	9.75	0.032	0.81
25070/15	15	0.433	11.00	0.032	0.81
25070/20	20	0.484	12.29	0.032	0.81
25070/25	25	0.542	13.77	0.032	0.81

*Conductors color-coded per international standards: brown, blue, green/yellow.

16 AWG (1.23 mm²)

Stranding: 19/0.0117 (19 x 0.29 mm)
Insulation thickness: 0.016 (0.41 mm)

Part No.	Conductors	Nominal Diameter		Jacket Thickness	
		Inch	mm	Inch	mm
25072	2	0.250	6.35	0.032	0.81
25072/1*	2	0.250	6.35	0.032	0.81
25073	3	0.264	6.71	0.032	0.81
25073/1*	3	0.264	6.71	0.032	0.81
25074	4	0.288	7.32	0.032	0.81
25076	6	0.343	8.71	0.032	0.81
25078	8	0.372	9.45	0.032	0.81
25080	10	0.432	10.97	0.032	0.81
25080/15	15	0.488	12.40	0.032	0.81
25080/20	20	0.547	13.89	0.053	1.35
25080/25	25	0.656	16.66	0.053	1.35

*Conductors color-coded per international standards: brown, blue, green/yellow.





Xtra-Guard® 2

Oil and Abrasion Resistant
600 V Unshielded, Multiconductor

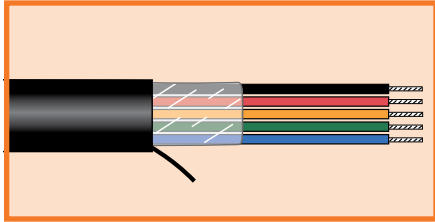

UL AWM 20952 VW-1
CSA AWM I/II A/B FT1

Operating Temperature

- -30°C to +105°C

Conductor Color Coding

- Chart E (page 532)
- Nine jacket colors (black standard)
- Custom colors available

Materials

- Stranded tinned copper conductors
- Premium PVC insulation
- Specially formulated polyurethane jacket
- UV resistant
- Nylon ripcord

Availability

Made to order
1000 ft (305 m) minimum

FIT® Tubing Recommendations

- FIT-750: Bonding adhesive lined, cross-linked polyolefin

18 AWG (0.81 mm²)

Stranding: 16/30 (16 x 0.25 mm)
Insulation thickness: 0.032 (0.81 mm)

Part No.	Conductors	Nominal Diameter		Jacket Thickness	
		Inch	mm	Inch	mm
25422	2	0.352	8.94	0.063	1.60
25423	3	0.369	9.37	0.063	1.60
25424	4	0.399	10.13	0.063	1.60
25427	7	0.466	11.84	0.063	1.60
25429	9	0.535	13.59	0.063	1.60
25429/12	12	0.591	15.01	0.063	1.60

16 AWG (1.23 mm²)

Stranding: 19/0.0117 (19 x 0.29 mm)
Insulation thickness: 0.032 (0.81 mm)

Part No.	Conductors	Nominal Diameter		Jacket Thickness	
		Inch	mm	Inch	mm
25432	2	0.376	9.55	0.063	1.60
25433	3	0.395	10.03	0.063	1.60
25434	4	0.428	10.87	0.063	1.60
25435	5	0.464	11.79	0.063	1.60
25439	9	0.579	14.71	0.063	1.60
25439/12	12	0.641	16.28	0.063	1.60
25439/19	19	0.746	18.95	0.083	2.11

14 AWG (2.08 mm²)

Stranding: 41/30 (41 x 0.25 mm)
Insulation thickness: 0.032 (0.81 mm)

Part No.	Conductors	Nominal Diameter		Jacket Thickness	
		Inch	mm	Inch	mm
25442	2	0.406	10.31	0.063	1.60
25443	3	0.428	10.87	0.063	1.60
25444	4	0.464	11.79	0.063	1.60
25445	5	0.505	12.83	0.063	1.60
25449	9	0.634	16.10	0.063	1.60
25449/12	12	0.703	17.86	0.063	1.60





Xtra-Guard® 2

Oil and Abrasion Resistant 300 V Foil Shielded, Multiconductor

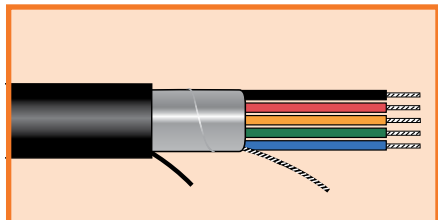

**UL AWM 20668 VW-1
CSA AWM I/II A/B FT1**

Operating Temperature

- 30°C to +90°C

Conductor Color Coding

- 24, 22 AWG: Chart E (page 532)
- 20, 18, 16 AWG: Chart D (page 531)
- Nine jacket colors (black standard)
- Custom colors available

Materials

- Stranded tinned copper conductors
- Premium PVC insulation
- Specially formulated polyurethane jacket
- UV resistant
- Aluminum/polyester/aluminum foil shield, with 25% overlap and foil facing inward
- Tinned copper drain wire sized the same as cable conductors
- Nylon ripcord

Availability

Made to order
1000 ft (305 m) minimum

FIT® Tubing Recommendations

- FIT-750: Bonding adhesive lined, cross-linked polyolefin

24 AWG (0.23 mm ²)					
Stranding: 7/32 (7 x 0.20 mm) Insulation thickness: 0.010 (0.25 mm)					
Part No.	Conductors	Nominal Diameter		Jacket Thickness	
		Inch	mm	Inch	mm
25092	2	0.160	4.06	0.032	0.81
25093	3	0.167	4.24	0.032	0.81
25094	4	0.179	4.55	0.032	0.81
25096	6	0.205	5.21	0.032	0.81
25098	8	0.219	5.56	0.032	0.81
25100	10	0.248	6.30	0.032	0.81
25100/15	15	0.275	6.99	0.032	0.81
25100/20	20	0.304	7.72	0.032	0.81
25100/25	25	0.336	8.53	0.032	0.81

22 AWG (0.35 mm ²)					
Stranding: 7/30 (7 x 0.25 mm) Insulation thickness: 0.010 (0.25 mm)					
Part No.	Conductors	Nominal Diameter		Jacket Thickness	
		Inch	mm	Inch	mm
25192	2	0.172	4.37	0.032	0.81
25193	3	0.180	4.57	0.032	0.81
25194	4	0.193	4.90	0.032	0.81
25196	6	0.223	5.66	0.032	0.81
25198	8	0.239	6.07	0.032	0.81
25199/10	10	0.272	6.91	0.032	0.81
25199/15	15	0.303	7.70	0.032	0.81
25199/20	20	0.335	8.51	0.032	0.81
25199/25	25	0.372	9.45	0.032	0.81
25199/30	30	0.393	9.98	0.032	0.81
25199/40	40	0.438	11.13	0.032	0.81
25199/50	50	0.482	12.24	0.032	0.81

20 AWG (0.56 mm ²)					
Stranding: 7/28 (7 x 0.32 mm) Insulation thickness: 0.016 (0.41 mm)					
Part No.	Conductors	Nominal Diameter		Jacket Thickness	
		Inch	mm	Inch	mm
25462	2	0.212	5.38	0.032	0.81
25463	3	0.223	5.66	0.032	0.81
25464	4	0.242	6.15	0.032	0.81
25466	6	0.284	7.21	0.032	0.81
25468	8	0.306	7.77	0.032	0.81
25470	10	0.352	8.94	0.032	0.81
25470/15	15	0.395	10.03	0.032	0.81
25470/20	20	0.441	11.20	0.032	0.81
25470/25	25	0.492	12.50	0.032	0.81
25470/30	30	0.521	13.23	0.032	0.81
25470/40	40	0.626	15.90	0.053	1.35
25470/50	50	0.688	17.48	0.053	1.35





Xtra-Guard® 2

Oil and Abrasion Resistant 300 V Foil Shielded, Multiconductor

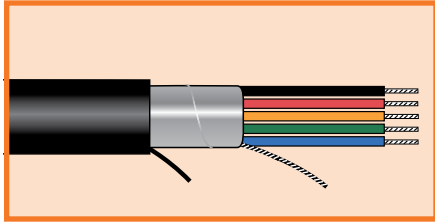

**UL AWM 20668 VW-1
CSA AWM I/II A/B FT1**

Operating Temperature

- -30°C to +90°C

Conductor Color Coding

- 24, 22 AWG: Chart E (page 532)
- 20, 18, 16 AWG: Chart D (page 531)
- Nine jacket colors (black standard)
- Custom colors available

Materials

- Stranded tinned copper conductors
- Premium PVC insulation
- Specially formulated polyurethane jacket
- UV resistant
- Aluminum/polyester/aluminum foil shield, with 25% overlap and foil facing inward
- Tinned copper drain wire sized the same as cable conductors
- Nylon ripcord

Availability

Made to order
1000 ft (305 m) minimum

FIT® Tubing Recommendations

- FIT-750: Bonding adhesive lined, cross-linked polyolefin

18 AWG (0.81 mm²)

Stranding: 16/30 (16 x 0.25 mm)
Insulation thickness: 0.016 (0.41 mm)

Part No.	Conductors	Nominal Diameter		Jacket Thickness	
		Inch	mm	Inch	mm
25382	2	0.230	5.84	0.032	0.81
25382/1*	2	0.230	5.84	0.032	0.81
25383	3	0.242	6.14	0.032	0.81
25383/1*	3	0.242	6.14	0.032	0.81
25384	4	0.263	6.68	0.032	0.81
25386	6	0.311	7.90	0.032	0.81
25388	8	0.336	8.53	0.032	0.81
25390	10	0.388	9.86	0.032	0.81
25390/15	15	0.437	11.10	0.032	0.81
25390/20	20	0.488	12.40	0.032	0.81
25390/25	25	0.588	14.94	0.053	1.35
25390/30	30	0.621	15.77	0.053	1.35
25390/40	40	0.692	17.58	0.053	1.35
25390/50	50	0.762	19.35	0.053	1.35

*Conductors color-coded per international standards: brown, blue, green/yellow.

16 AWG (1.23 mm²)

Stranding: 19/0.0117 (19 x 0.29 mm)
Insulation thickness: 0.016 (0.41 mm)

Part No.	Conductors	Nominal Diameter		Jacket Thickness	
		Inch	mm	Inch	mm
25362	2	0.254	6.45	0.032	0.81
25362/1*	2	0.254	6.45	0.032	0.81
25363	3	0.268	6.81	0.032	0.81
25363/1*	3	0.268	6.81	0.032	0.81
25364	4	0.292	7.42	0.032	0.81
25366	6	0.347	8.81	0.032	0.81
25368	8	0.376	9.55	0.032	0.81
25370	10	0.436	11.07	0.032	0.81
25370/15	15	0.492	12.50	0.032	0.81
25370/20	20	0.593	15.06	0.053	1.35
25370/25	25	0.660	16.76	0.053	1.35
25370/30	30	0.698	17.73	0.053	1.35
25370/40	40	0.779	19.79	0.083	2.11
25370/50	50	0.921	23.39	0.083	2.11

*Conductors color-coded per international standards: brown, blue, green/yellow.





Xtra-Guard® 2

Oil and Abrasion Resistant 600 V Foil Shielded, Multiconductor

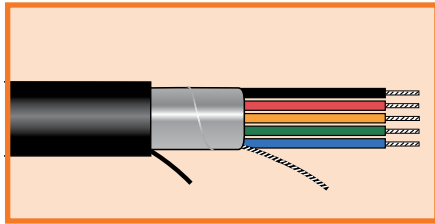

**UL AWM 20952 VW-1
CSA AWM I/II A/B FT1**

Operating Temperature

- -30°C to +105°C

Conductor Color Coding

- Chart E (page 532)
- Nine jacket colors (black standard)
- Custom colors available

Materials

- Stranded tinned copper conductors
- Premium PVC insulation
- Specially formulated polyurethane jacket
- UV resistant
- Aluminum/polyester/aluminum foil shield, with 25% overlap and foil facing inward
- Tinned copper drain wire sized the same as cable conductors
- Nylon ripcord

Availability

Made to order
1000 ft (305 m) minimum

FIT® Tubing Recommendations

- FIT-750: Bonding adhesive lined, cross-linked polyolefin

18 AWG (0.81 mm²)

Stranding: 16/30 (16 x 0.25 mm)
Insulation thickness: 0.032 (0.81 mm)

Part No.	Conductors	Nominal Diameter		Jacket Thickness	
		Inch	mm	Inch	mm
25430/2	2	0.356	9.04	0.063	1.60
25430/3	3	0.373	9.47	0.063	1.60
25430/4	4	0.403	10.24	0.063	1.60
25430/5	5	0.436	11.07	0.063	1.60
25430/7	7	0.470	11.94	0.063	1.60
25430/9	9	0.539	13.69	0.063	1.60
25430/12	12	0.595	15.11	0.063	1.60
25430/15	15	0.647	16.43	0.063	1.60
25430/19	19	0.690	17.53	0.063	1.60

16 AWG (1.23 mm²)

Stranding: 19/0.0117 (19 x 0.29 mm)
Insulation thickness: 0.032 (0.81 mm)

Part No.	Conductors	Nominal Diameter		Jacket Thickness	
		Inch	mm	Inch	mm
25440/2	2	0.380	9.65	0.063	1.60
25440/3	3	0.399	10.13	0.063	1.60
25440/4	4	0.432	10.97	0.063	1.60
25440/5	5	0.468	11.89	0.063	1.60
25440/7	7	0.506	12.85	0.063	1.60
25440/9	9	0.583	14.81	0.063	1.60
25440/12	12	0.645	16.38	0.063	1.60
25440/15	15	0.702	17.83	0.063	1.60

14 AWG (2.08 mm²)

Stranding: 41/30 (41 x 0.25 mm)
Insulation thickness: 0.032 (0.81 mm)

Part No.	Conductors	Nominal Diameter		Jacket Thickness	
		Inch	mm	Inch	mm
25450/2	2	0.410	10.41	0.063	1.60
25450/3	3	0.432	10.97	0.063	1.60
25450/4	4	0.468	11.89	0.063	1.60
25450/5	5	0.509	12.93	0.063	1.60
25450/7	7	0.551	14.00	0.063	1.60
25450/9	9	0.638	16.21	0.063	1.60
25450/12	12	0.707	17.96	0.063	1.60
25450/15	15	0.771	19.58	0.063	1.60





Xtra-Guard® 2

Oil and Abrasion Resistant 300 V Supra-Shield® Foil/Braid, Multiconductor

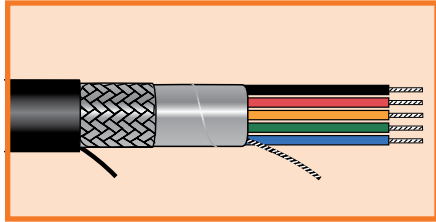

UL AWM 20668 VW-1
CSA AWM I/II A/B FT1

Operating Temperature

- -30°C to +90°C

Conductor Color Coding

- 24, 22 AWG: Chart E (page 532)
- 20, 18, 16 AWG: Chart D (page 531)
- Nine jacket colors (black standard)
- Custom colors available

Materials

- Stranded tinned copper conductors
- Premium PVC insulation
- Specially formulated polyurethane jacket
- UV resistant
- Supra-Shield foil + braid shield: Aluminum/polyester/aluminum foil with 25% overlap min. Tinned copper drain wire sized the same as conductors Tinned copper braid, 70% coverage min.
- Nylon ripcord

Availability

Made to order
1000 ft (305 m) minimum

FIT® Tubing Recommendations

- FIT-750: Bonding adhesive lined, cross-linked polyolefin



24 AWG (0.23 mm²)

Stranding: 7/32 (7 x 0.20 mm)
Insulation thickness: 0.010 (0.25 mm)

Part No.	Conductors	Nominal Diameter		Jacket Thickness	
		Inch	mm	Inch	mm
25112	2	0.184	4.67	0.032	0.81
25113	3	0.191	4.85	0.032	0.81
25114	4	0.203	5.16	0.032	0.81
25116	6	0.229	5.82	0.032	0.81
25118	8	0.243	6.17	0.032	0.81
25120	10	0.272	6.91	0.032	0.81
25120/15	15	0.299	7.59	0.032	0.81
25120/20	20	0.328	8.33	0.032	0.81
25120/25	25	0.360	9.14	0.032	0.81
25120/30	30	0.378	9.60	0.032	0.81
25120/40	40	0.418	10.62	0.032	0.81
25120/50	50	0.457	11.61	0.032	0.81

22 AWG (0.35 mm²)

Stranding: 7/30 (7 x 0.25 mm)
Insulation thickness: 0.010 (0.25 mm)

Part No.	Conductors	Nominal Diameter		Jacket Thickness	
		Inch	mm	Inch	mm
25102	2	0.196	4.97	0.032	0.81
25103	3	0.204	5.18	0.032	0.81
25104	4	0.217	5.51	0.032	0.81
25106	6	0.247	6.27	0.032	0.81
25108	8	0.263	6.68	0.032	0.81
25110	10	0.296	7.52	0.032	0.81
25110/15	15	0.327	8.31	0.032	0.81
25110/20	20	0.359	9.12	0.032	0.81
25110/25	25	0.396	10.06	0.032	0.81
25110/30	30	0.417	10.59	0.032	0.81
25110/40	40	0.462	11.73	0.032	0.81
25110/50	50	0.506	12.85	0.032	0.81

20 AWG (0.56 mm²)

Stranding: 7/28 (7 x 0.32 mm)
Insulation thickness: 0.016 (0.41 mm)

Part No.	Conductors	Nominal Diameter		Jacket Thickness	
		Inch	mm	Inch	mm
25152	2	0.236	5.99	0.032	0.81
25153	3	0.247	6.27	0.032	0.81
25154	4	0.266	6.76	0.032	0.81
25156	6	0.308	7.82	0.032	0.81
25158	8	0.330	8.38	0.032	0.81
25160	10	0.376	9.55	0.032	0.81
25160/15	15	0.419	10.64	0.032	0.81
25160/20	20	0.465	11.81	0.032	0.81
25160/25	25	0.516	13.11	0.032	0.81
25160/30	30	0.545	13.84	0.032	0.81
25160/40	40	0.656	16.66	0.053	1.35
25160/50	50	0.718	18.24	0.053	1.35



Xtra-Guard® 2

Oil and Abrasion Resistant 300 V Supra-Shield® Foil/Braid, Multiconductor

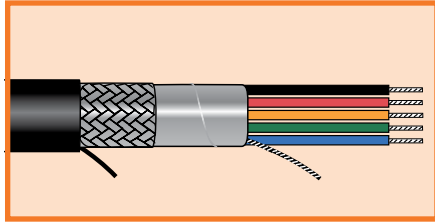

**UL AWM 20668 VW-1
CSA AWM I/II A/B FT1**

Operating Temperature

- -30°C to +90°C

Conductor Color Coding

- 24, 22 AWG: Chart E (page 532)
- 20, 18, 16 AWG: Chart D (page 531)
- Nine jacket colors (black standard)
- Custom colors available

Materials

- Stranded tinned copper conductors
- Premium PVC insulation
- Specially formulated polyurethane jacket
- UV resistant
- Supra-Shield foil + braid shield: Aluminum/polyester/aluminum foil with 25% overlap min. Tinned copper drain wire sized the same as conductors Tinned copper braid, 70% coverage min.
- Nylon ripcord

Availability

Made to order
1000 ft (305 m) minimum

FIT® Tubing Recommendations

- FIT-750: Bonding adhesive lined, cross-linked polyolefin

18 AWG (0.81 mm²)

Stranding: 16/30 (16 x 0.25 mm)
Insulation thickness: 0.016 (0.41 mm)

Part No.	Conductors	Nominal Diameter		Jacket Thickness	
		Inch	mm	Inch	mm
25162	2	0.254	6.45	0.032	0.81
25162/1*	2	0.254	6.45	0.032	0.81
25163	3	0.266	6.76	0.032	0.81
25163/1*	3	0.266	6.76	0.032	0.81
25164	4	0.287	7.29	0.032	0.81
25166	6	0.335	8.51	0.032	0.81
25168	8	0.360	9.14	0.032	0.81
25170	10	0.412	10.46	0.032	0.81
25170/15	15	0.461	11.71	0.032	0.81
25170/20	20	0.512	13.00	0.032	0.81
25170/25	25	0.612	15.54	0.053	1.35
25170/30	30	0.651	16.54	0.053	1.35
25170/40	40	0.722	18.34	0.053	1.35

*Conductors color-coded per international standards: brown, blue, green/yellow.

16 AWG (1.23 mm²)

Stranding: 19/0.0117 (19 x 0.29 mm)
Insulation thickness: 0.016 (0.41 mm)

Part No.	Conductors	Nominal Diameter		Jacket Thickness	
		Inch	mm	Inch	mm
25172	2	0.278	7.06	0.032	0.81
25172/1*	2	0.278	7.06	0.032	0.81
25173	3	0.292	7.42	0.032	0.81
25173/1*	3	0.292	7.42	0.032	0.81
25174	4	0.316	8.03	0.032	0.81
25176	6	0.371	9.42	0.032	0.81
25178	8	0.400	10.16	0.032	0.81
25180	10	0.460	11.68	0.032	0.81
25180/15	15	0.516	13.11	0.032	0.81
25180/20	20	0.617	15.67	0.053	1.35
25180/25	25	0.690	17.53	0.053	1.35
25180/30	30	0.728	18.49	0.053	1.35
25180/40	40	0.869	22.07	0.083	2.11

*Conductors color-coded per international standards: brown, blue, green/yellow.





Xtra-Guard® 2

Oil and Abrasion Resistant 600 V Supra-Shield® Foil/Braid, Multiconductor

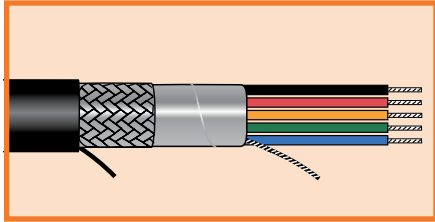

UL AWM 20952 VW-1
CSA AWM I/II A/B FT1

Operating Temperature

- -30°C to +105°C

Conductor Color Coding

- Chart E (page 532)
- Nine jacket colors (black standard)
- Custom colors available

Materials

- Stranded tinned copper conductors
- Premium PVC insulation
- Specially formulated polyurethane jacket
- UV resistant
- Supra-Shield foil + braid shield: Aluminum/polyester/aluminum foil with 25% overlap min. Tinned copper drain wire sized the same as conductors Tinned copper braid, 70% coverage min.
- Nylon ripcord

Availability

Made to order
1000 ft (305 m) minimum

FIT® Tubing Recommendations

- FIT-750: Bonding adhesive lined, cross-linked polyolefin

18 AWG (0.81 mm²)

Stranding: 16/30 (16 x 0.25 mm)
Insulation thickness: 0.032 (0.81 mm)

Part No.	Conductors	Nominal Diameter		Jacket Thickness	
		Inch	mm	Inch	mm
25522	2	0.380	9.65	0.063	1.60
25523	3	0.397	10.08	0.063	1.60
25524	4	0.427	10.85	0.063	1.60
25525	5	0.460	11.68	0.063	1.60
25527	7	0.494	12.55	0.063	1.60
25529	9	0.563	14.30	0.063	1.60

16 AWG (1.23 mm²)

Stranding: 19/0.0117 (19 x 0.29 mm)
Insulation thickness: 0.032 (0.81 mm)

Part No.	Conductors	Nominal Diameter		Jacket Thickness	
		Inch	mm	Inch	mm
25532	2	0.404	10.26	0.063	1.60
25533	3	0.423	10.74	0.063	1.60
25534	4	0.456	11.58	0.063	1.60
25535	5	0.492	12.50	0.063	1.60
25537	7	0.530	13.46	0.063	1.60
25539	9	0.607	15.42	0.063	1.60
25539/12	12	0.675	17.15	0.063	1.60
25539/15	15	0.772	19.61	0.083	2.11
25539/19	19	0.820	20.83	0.083	2.11

14 AWG (2.08 mm²)

Stranding: 41/30 (41 x 0.25 mm)
Insulation thickness: 0.032 (0.81 mm)

Part No.	Conductors	Nominal Diameter		Jacket Thickness	
		Inch	mm	Inch	mm
25542	2	0.434	11.02	0.063	1.60
25543	3	0.456	11.58	0.063	1.60
25544	4	0.492	12.50	0.063	1.60
25545	5	0.533	13.54	0.063	1.60
25547	7	0.575	14.61	0.063	1.60
25549	9	0.668	16.97	0.063	1.60
25549/12	12	0.777	19.74	0.083	2.11





Xtra-Guard® 2

Oil and Abrasion Resistant
300 V Foil Shield, Multipair

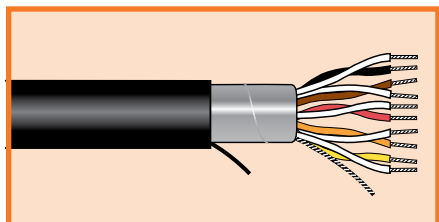

UL AWM 20668 VW-1
CSA AWM I/II A/B FT1

Operating Temperature

- -30°C to +90°C

Conductor Color Coding

- 24, 22 AWG: Chart B (page 528)
- 20, 18 AWG: Chart A (page 528)
- Nine jacket colors (black standard)
- Custom colors available

Materials

- Stranded tinned copper conductors
- Premium PVC insulation
- Specially formulated polyurethane jacket
- UV resistant
- Aluminum/polyester/aluminum foil shield, with 25% overlap and foil facing inward
- Tinned copper drain wire sized the same as cable conductors
- Nylon ripcord

Availability

Made to order
1000 ft (305 m) minimum

FIT® Tubing Recommendations

- FIT-750: Bonding adhesive lined, cross-linked polyolefin

24 AWG (0.23 mm²)

Stranding: 7/32 (7 x 0.20 mm)
Insulation thickness: 0.010 (0.25 mm)

Part No.	Pairs	Nominal Diameter		Jacket Thickness	
		Inch	mm	Inch	mm
25491	1	0.160	4.06	0.032	0.81
25492	2	0.216	5.48	0.032	0.81
25493	3	0.228	5.79	0.032	0.81
25494	4	0.247	6.27	0.032	0.81
25495	5	0.268	6.81	0.032	0.81
25496	6	0.290	7.37	0.032	0.81
25499	9	0.336	8.53	0.032	0.81
25499/11	11	0.361	9.17	0.032	0.81
25499/15	15	0.405	10.29	0.032	0.81
25499/19	19	0.433	11.00	0.032	0.81
25499/27	27	0.516	13.11	0.032	0.81

22 AWG (0.35 mm²)

Stranding: 7/30 (7 x 0.25 mm)
Insulation thickness: 0.010 (0.25 mm)

Part No.	Pairs	Nominal Diameter		Jacket Thickness	
		Inch	mm	Inch	mm
25481	1	0.172	4.37	0.032	0.81
25482	2	0.236	5.99	0.032	0.81
25483	3	0.249	6.32	0.032	0.81
25484	4	0.271	6.88	0.032	0.81
25485	5	0.295	7.49	0.032	0.81
25486	6	0.320	8.13	0.032	0.81
25489	9	0.372	9.45	0.032	0.81
25489/11	11	0.400	10.16	0.032	0.81
25489/15	15	0.451	11.46	0.032	0.81
25489/19	19	0.483	12.27	0.032	0.81





Xtra-Guard® 2

Oil and Abrasion Resistant
300 V Foil Shield, Multipair

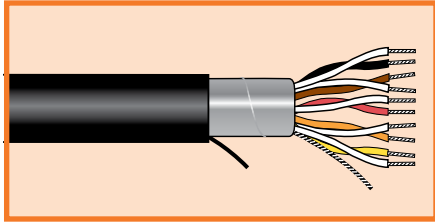

UL AWM 20668 VW-1
CSA AWM I/II A/B FT1

Operating Temperature

- -30°C to +90°C

Conductor Color Coding

- 24, 22 AWG: Chart B (page 528)
- 20, 18 AWG: Chart A (page 528)
- Nine jacket colors (black standard)
- Custom colors available

Materials

- Stranded tinned copper conductors
- Premium PVC insulation
- Specially formulated polyurethane jacket
- UV resistant
- Aluminum/polyester/aluminum foil shield, with 25% overlap and foil facing inward
- Tinned copper drain wire sized the same as cable conductors
- Nylon ripcord

Availability

Made to order
1000 ft (305 m) minimum

FIT® Tubing Recommendations

- FIT-750: Bonding adhesive lined, cross-linked polyolefin

20 AWG (0.56 mm²)

Stranding: 7/28 (7 x 0.32 mm)
Insulation thickness: 0.016 (0.41 mm)

Part No.	Pairs	Nominal Diameter		Jacket Thickness	
		Inch	mm	Inch	mm
25452	2	0.302	7.67	0.032	0.81
25453	3	0.320	8.13	0.032	0.81
25456	6	0.419	10.64	0.032	0.81
25459	9	0.491	12.47	0.032	0.81
25459/12	12	0.549	13.94	0.032	0.81
25459/15	15	0.644	16.36	0.053	1.35

18 AWG (0.81 mm²)

Stranding: 16/30 (16 x 0.25 mm)
Insulation thickness: 0.016 (0.41 mm)

Part No.	Pairs	Nominal Diameter		Jacket Thickness	
		Inch	mm	Inch	mm
25372	2	0.331	8.41	0.032	0.81
25373	3	0.352	8.94	0.032	0.81
25376	6	0.464	11.79	0.032	0.81
25379	9	0.545	13.84	0.053	1.35
25379/12	12	0.652	16.56	0.053	1.35





Xtra-Guard® 2

Oil and Abrasion Resistant
300 V Supra-Shield® Foil/Braid, Multipair

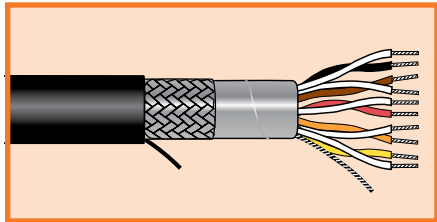

UL AWM 20668 VW-1
CSA AWM I/II A/B FT1

Operating Temperature

- -30°C to +90°C

Conductor Color Coding

- 24, 22 AWG: Chart B (page 528)
- 20, 18 AWG: Chart A (page 528)
- Nine jacket colors (black standard)
- Custom colors available

Materials

- Stranded tinned copper conductors
- Premium PVC insulation
- Specially formulated polyurethane jacket
- UV resistant
- Supra-Shield foil + braid shield: Aluminum/polyester/aluminum foil with 25% overlap min. Tinned copper drain wire sized the same as conductors Tinned copper braid, 70% coverage min.
- Nylon ripcord

Availability

Made to order
1000 ft (305 m) minimum

FIT® Tubing Recommendations

- FIT-750: Bonding adhesive lined, cross-linked polyolefin

24 AWG (0.23 mm²)

Stranding: 7/32 (7 x 0.20 mm)
Insulation thickness: 0.010 (0.25 mm)

Part No.	Pairs	Nominal Diameter		Jacket Thickness	
		Inch	mm	Inch	mm
25271	1	0.184	4.67	0.032	0.81
25272	2	0.240	6.10	0.032	0.81
25273	3	0.252	6.40	0.032	0.81
25274	4	0.271	6.88	0.032	0.81
25275	5	0.292	7.42	0.032	0.81
25276	6	0.314	7.98	0.032	0.81
25279	9	0.360	9.14	0.032	0.81
25279/11	11	0.385	9.78	0.032	0.81
25279/15	15	0.429	10.90	0.032	0.81
25279/19	19	0.457	11.61	0.032	0.81

22 AWG (0.35 mm²)

Stranding: 7/30 (7 x 0.25 mm)
Insulation thickness: 0.010 (0.25 mm)

Part No.	Pairs	Nominal Diameter		Jacket Thickness	
		Inch	mm	Inch	mm
25121	1	0.196	4.98	0.032	0.81
25122	2	0.260	6.60	0.032	0.81
25123	3	0.273	6.93	0.032	0.81
25124	4	0.295	7.49	0.032	0.81
25125	5	0.319	8.10	0.032	0.81
25126	6	0.344	8.74	0.032	0.81
25129	9	0.396	10.06	0.032	0.81
25129/11	11	0.424	10.77	0.032	0.81
25129/15	15	0.475	12.07	0.032	0.81





Xtra-Guard® 2

Oil and Abrasion Resistant
300 V Supra-Shield® Foil/Braid, Multipair

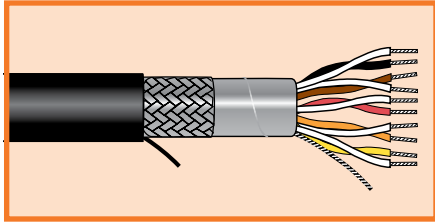

UL AWM 20668 VW-1
CSA AWM I/II A/B FT1

Operating Temperature

- -30°C to +90°C

Conductor Color Coding

- 24, 22 AWG: Chart B (page 528)
- 20, 18 AWG: Chart A (page 528)
- Nine jacket colors (black standard)
- Custom colors available

Materials

- Stranded tinned copper conductors
- Premium PVC insulation
- Specially formulated polyurethane jacket
- UV resistant
- Supra-Shield foil + braid shield: Aluminum/polyester/aluminum foil with 25% overlap min. Tinned copper drain wire sized the same as conductors Tinned copper braid, 70% coverage min.
- Nylon ripcord

Availability

Made to order
1000 ft (305 m) minimum

FIT® Tubing Recommendations

- FIT-750: Bonding adhesive lined, cross-linked polyolefin

20 AWG (0.56 mm²)

Stranding: 7/28 (7 x 0.32 mm)
Insulation thickness: 0.016 (0.41 mm)

Part No.	Pairs	Nominal Diameter		Jacket Thickness	
		Inch	mm	Inch	mm
25292	2	0.326	8.28	0.032	0.81
25293	3	0.344	8.74	0.032	0.81
25296	6	0.443	11.25	0.032	0.81
25299	9	0.515	13.08	0.032	0.81

18 AWG (0.81 mm²)

Stranding: 16/30 (16 x 0.25 mm)
Insulation thickness: 0.016 (0.41 mm)

Part No.	Pairs	Nominal Diameter		Jacket Thickness	
		Inch	mm	Inch	mm
25132	2	0.355	9.02	0.032	0.81
25133	3	0.376	9.55	0.032	0.81
25136	6	0.488	12.40	0.032	0.81
25139	9	0.611	15.52	0.053	1.35
25139/12	12	0.682	17.32	0.053	1.35



Xtra-Guard® 3

Direct Burial



Features

- The preferred outdoor cable for direct burial
- Resistant to the effects of weathering, moisture, and UV aging without the costly use of conduit
- 6 times the water resistance of PVC
- Specially formulated polyethylene jacket for outstanding service life and ultraviolet light stability in all jacket colors
- Fast, easy stripping of insulation and jacket
- Color-coded, tinned copper conductors
- 300 V and 600 V
- Unshielded, foil shielded, or Supra-Shield® foil/braid
- Temperature ratings to 80°C
- Outstanding ultraviolet light stability in all jacket colors

Applications

- Interbuilding communications
- Satellite communications equipment
- Land irrigation systems
- Outdoor security systems
- Outdoor scoreboards and displays
- Pipeline sensor controls

FIT® Tubing Recommendations

- FIT-700: Bonding thermoplastic adhesive lined, cross-linked polyolefin

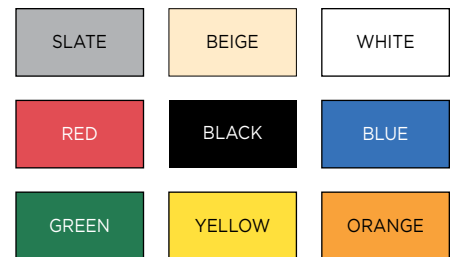

Xtra-Guard cables are available in a range of long-lasting colors for fast, easy identification, for safety reasons, and for matching the color of your system.

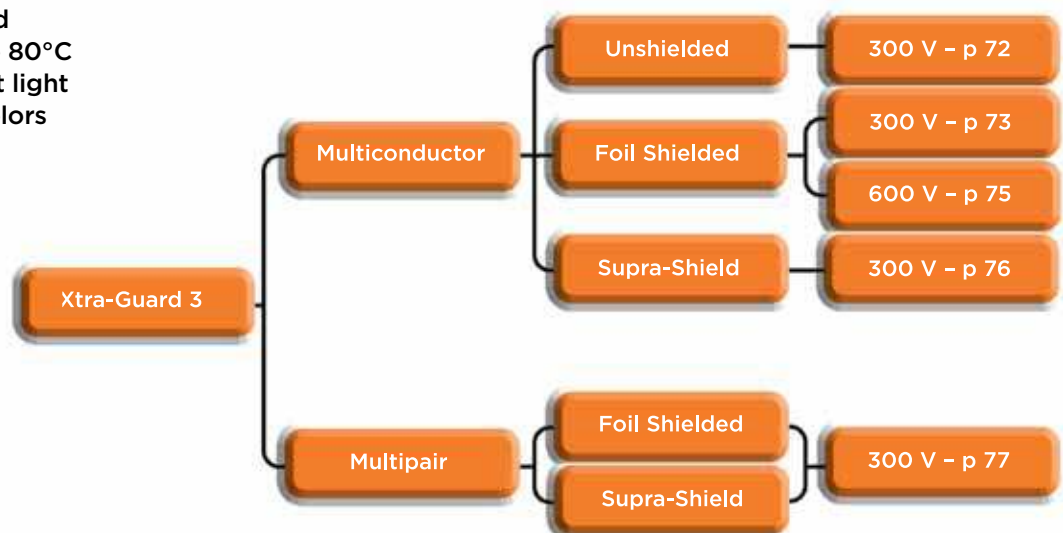

Xtra-Guard® 3



Direct Burial 300 V Unshielded, Multiconductor

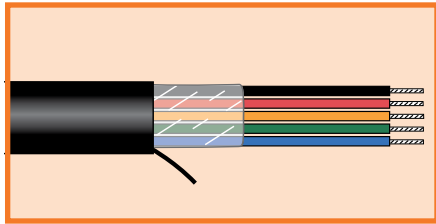

Operating Temperature

- -30°C to +80°C

Conductor Color Coding

- 22 AWG: Chart E (page 532)
- 20, 18, 16 AWG: Chart D (page 531)
- Nine jacket colors (black standard)
- Custom colors available

Materials

- Stranded tinned copper conductors
- Premium PVC insulation
- Specially formulated polyethylene jacket
- UV resistant
- Nylon ripcord

Availability

Made to order
1000 ft (305 m) minimum

FIT® Tubing Recommendations

- FIT-700: Bonding, thermoplastic adhesive lined, cross-linked polyolefin

22 AWG (0.35 mm²)

Stranding: 7/30 (7 x 0.25 mm)
Insulation thickness: 0.010 (0.25 mm)

Part No.	Conductors	Nominal Diameter		Jacket Thickness	
		Inch	mm	Inch	mm
35002	2	0.167	4.24	0.032	0.81
35003	3	0.175	4.45	0.032	0.81
35004	4	0.188	4.78	0.032	0.81
35006	6	0.218	5.54	0.032	0.81
35008	8	0.233	5.92	0.032	0.81
35010	10	0.267	6.78	0.032	0.81
35010/15	15	0.297	7.54	0.032	0.81

20 AWG (0.56 mm²)

Stranding: 7/28 (7 x 0.32 mm)
Insulation thickness: 0.016 (0.41 mm)

Part No.	Conductors	Nominal Diameter		Jacket Thickness	
		Inch	mm	Inch	mm
35052	2	0.207	5.26	0.032	0.81
35053	3	0.218	5.54	0.032	0.81
35054	4	0.236	5.99	0.032	0.81
35056	6	0.278	7.06	0.032	0.81
35058	8	0.300	7.62	0.032	0.81
35060	10	0.347	8.81	0.032	0.81
35060/15	15	0.389	9.88	0.032	0.81

18 AWG (0.81 mm²)

Stranding: 16/30 (16 x 0.25 mm)
Insulation thickness: 0.016 (0.41 mm)

Part No.	Conductors	Nominal Diameter		Jacket Thickness	
		Inch	mm	Inch	mm
35062	2	0.225	5.72	0.032	0.81
35063	3	0.237	6.02	0.032	0.81
35064	4	0.258	6.55	0.032	0.81
35066	6	0.305	7.75	0.032	0.81
35068	8	0.330	8.38	0.032	0.81
35070	10	0.383	9.73	0.032	0.81
35070/15	15	0.430	10.92	0.032	0.81

16 AWG (1.23 mm²)

Stranding: 19/0.0117 (19 x 0.29 mm)
Insulation thickness: 0.016 (0.41 mm)

Part No.	Conductors	Nominal Diameter		Jacket Thickness	
		Inch	mm	Inch	mm
35072	2	0.249	6.32	0.032	0.81
35073	3	0.263	6.68	0.032	0.81
35074	4	0.287	7.29	0.032	0.81
35076	6	0.341	8.66	0.032	0.81
35078	8	0.370	9.40	0.032	0.81
35080	10	0.431	10.95	0.032	0.81
35080/15	15	0.485	12.32	0.032	0.81





Xtra-Guard® 3

Direct Burial 300 V Foil Shield, Multiconductor

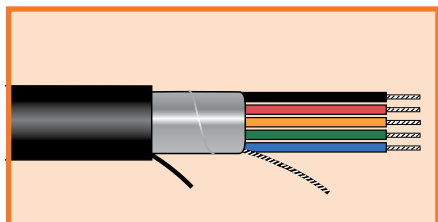

Operating Temperature

- -30°C to +80°C

Conductor Color Coding

- 22 AWG: Chart E (page 532)
- 20 AWG: Chart D (page 531)
- Nine jacket colors (black standard)
- Custom colors available

Materials

- Stranded tinned copper conductors
- Premium PVC insulation
- Specially formulated polyethylene jacket
- UV resistant
- Aluminum/polyester foil shield, with 25% overlap and foil facing inward
- Tinned copper drain wire sized the same as cable conductors
- Nylon ripcord

Availability

Made to order
1000 ft (305 m) minimum

FIT® Tubing Recommendations

- FIT-700: Bonding, thermoplastic adhesive lined, cross-linked polyolefin

22 AWG (0.35 mm²)

Stranding: 7/30 (7 x 0.25 mm)
Insulation thickness: 0.010 (0.25 mm)

Part No.	Conductors	Nominal Diameter		Jacket Thickness	
		Inch	mm	Inch	mm
35192	2	0.171	4.34	0.032	0.81
35193	3	0.179	4.55	0.032	0.81
35194	4	0.192	4.88	0.032	0.81
35196	6	0.222	5.64	0.032	0.81
35198	8	0.237	6.02	0.032	0.81
35199/10	10	0.271	6.88	0.032	0.81
35199/15	15	0.301	7.65	0.032	0.81
35199/20	20	0.333	8.46	0.032	0.81
35199/25	25	0.371	9.42	0.032	0.81
35199/30	30	0.392	9.96	0.032	0.81
35199/40	40	0.436	11.07	0.032	0.81
35199/50	50	0.479	12.17	0.032	0.81
35199/60	60	0.521	13.23	0.032	0.81

20 AWG (0.56 mm²)

Stranding: 7/28 (7 x 0.32 mm)
Insulation thickness: 0.016 (0.41 mm)

Part No.	Conductors	Nominal Diameter		Jacket Thickness	
		Inch	mm	Inch	mm
35462	2	0.211	5.36	0.032	0.81
35463	3	0.222	5.64	0.032	0.81
35464	4	0.240	6.10	0.032	0.81
35466	6	0.282	7.16	0.032	0.81
35468	8	0.304	7.72	0.032	0.81
35470	10	0.351	8.92	0.032	0.81
35470/15	15	0.393	9.98	0.032	0.81
35470/20	20	0.437	11.10	0.032	0.81
35470/25	25	0.491	12.47	0.032	0.81





Xtra-Guard® 3

Direct Burial 300 V Foil Shield, Multiconductor

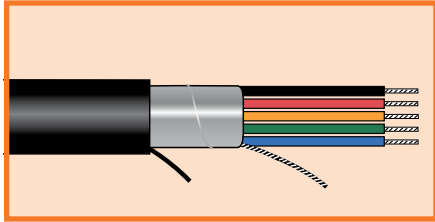

Operating Temperature

- -30°C to +80°C

Conductor Color Coding

- Chart D (page 531)
- Nine jacket colors (black standard)
- Custom colors available

Materials

- Stranded tinned copper conductors
- Premium PVC insulation
- Specially formulated polyethylene jacket
- UV resistant
- Aluminum/polyester foil shield, with 25% overlap and foil facing inward
- Tinned copper drain wire sized the same as cable conductors
- Nylon ripcord

Availability

Made to order
1000 ft (305 m) minimum

FIT® Tubing Recommendations

- FIT-700: Bonding, thermoplastic adhesive lined, cross-linked polyolefin

18 AWG (0.81 mm²)

Stranding: 16/30 (16 x 0.25 mm)
Insulation thickness: 0.016 (0.41 mm)

Part No.	Conductors	Nominal Diameter		Jacket Thickness	
		Inch	mm	Inch	mm
35382	2	0.229	5.82	0.032	0.81
35383	3	0.241	6.12	0.032	0.81
35384	4	0.262	6.65	0.032	0.81
35386	6	0.309	7.85	0.032	0.81
35388	8	0.334	8.48	0.032	0.81
35390	10	0.387	9.83	0.032	0.81
35390/15	15	0.434	11.02	0.032	0.81
35390/20	20	0.485	12.32	0.032	0.81
35390/25	25	0.587	14.91	0.053	1.35

16 AWG (1.23 mm²)

Stranding: 19/0.0117 (19 x 0.29 mm)
Insulation thickness: 0.016 (0.41 mm)

Part No.	Conductors	Nominal Diameter		Jacket Thickness	
		Inch	mm	Inch	mm
35362	2	0.253	6.43	0.032	0.81
35363	3	0.267	6.78	0.032	0.81
35364	4	0.291	7.39	0.032	0.81
35366	6	0.345	8.76	0.032	0.81
35368	8	0.374	9.50	0.032	0.81
35370	10	0.435	11.05	0.032	0.81
35370/15	15	0.489	12.42	0.032	0.81
35370/20	20	0.589	14.96	0.053	1.35
35370/25	25	0.659	16.74	0.053	1.35





Xtra-Guard® 3

Direct Burial 600 V Foil Shield, Multiconductor

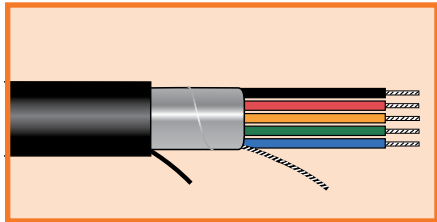

Operating Temperature

- -30°C to +80°C

Conductor Color Coding

- Chart D (page 531)
- Nine jacket colors (black standard)
- Custom colors available

Materials

- Stranded tinned copper conductors
- Premium PVC insulation
- Specially formulated polyethylene jacket
- UV resistant
- Aluminum/polyester foil shield, with 25% overlap and foil facing inward
- Tinned copper drain wire sized the same as cable conductors
- Nylon ripcord

Availability

Made to order
1000 ft (305 m) minimum

FIT® Tubing Recommendations

- FIT-700: Bonding, thermoplastic adhesive lined, cross-linked polyolefin

18 AWG (0.81 mm ²)					
Stranding: 16/30 (16 x 0.25 mm) Insulation thickness: 0.032 (0.81 mm)					
Part No.	Conductors	Nominal Diameter		Jacket Thickness	
		Inch	mm	Inch	mm
35430/2	2	0.355	9.02	0.063	1.60
35430/3	3	0.372	9.45	0.063	1.60
35430/5	5	0.434	11.02	0.063	1.60
35430/7	7	0.468	11.89	0.063	1.60
35430/9	9	0.537	13.64	0.063	1.60
35430/12	12	0.594	15.09	0.063	1.60

16 AWG (1.23 mm ²)					
Stranding: 19/0.0117 (19 x 0.29 mm) Insulation thickness: 0.032 (0.81 mm)					
Part No.	Conductors	Nominal Diameter		Jacket Thickness	
		Inch	mm	Inch	mm
35440/2	2	0.379	9.63	0.063	1.60
35440/3	3	0.398	10.11	0.063	1.60
35440/5	5	0.466	11.84	0.063	1.60
35440/7	7	0.504	12.80	0.063	1.60
35440/9	9	0.581	14.76	0.063	1.60
35440/12	12	0.644	16.36	0.063	1.60

14 AWG (2.08 mm ²)					
Stranding: 41/30 (41 x 0.25 mm) Insulation thickness: 0.032 (0.81 mm)					
Part No.	Conductors	Nominal Diameter		Jacket Thickness	
		Inch	mm	Inch	mm
35450/2	2	0.409	10.39	0.063	1.60
35450/3	3	0.431	10.95	0.063	1.60
35450/5	5	0.507	12.88	0.063	1.60
35450/7	7	0.549	13.94	0.063	1.60
35450/9	9	0.635	16.13	0.063	1.60
35450/12	12	0.706	17.93	0.063	1.60





Xtra-Guard® 3

Direct Burial

300 V Supra-Shield® Foil/Braid, Multiconductor

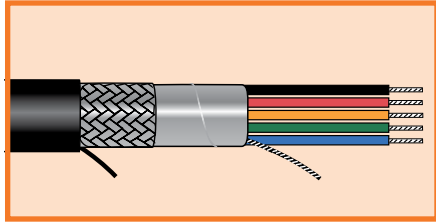

Operating Temperature

- -30°C to +80°C

Conductor Color Coding

- 22 AWG: Chart E (page 532)
- 20, 18, 16 AWG: Chart D (page 531)
- Nine jacket colors (black standard)
- Custom colors available

Materials

- Stranded tinned copper conductors
- Premium PVC insulation
- Specially formulated polyethylene jacket
- UV resistant
- Supra-Shield foil + braid shield: Aluminum/polyester/aluminum foil with 25% overlap min. Tinned copper drain wire sized the same as conductors
- Tinned copper braid, 70% coverage min.
- Nylon ripcord

Availability

Made to order
1000 ft (305 m) minimum

FIT® Tubing Recommendations

- FIT-700: Bonding, thermoplastic adhesive lined, cross-linked polyolefin



22 AWG (0.35 mm²)

Stranding: 7/30 (7 x 0.25 mm)
Insulation thickness: 0.010 (0.25 mm)

Part No.	Conductors	Nominal Diameter		Jacket Thickness	
		Inch	mm	Inch	mm
35102	2	0.195	4.95	0.032	0.81
35103	3	0.203	5.16	0.032	0.81
35104	4	0.216	5.49	0.032	0.81
35106	6	0.246	6.25	0.032	0.81
35108	8	0.261	6.63	0.032	0.81
35110	10	0.295	7.49	0.032	0.81
35110/15	15	0.325	8.26	0.032	0.81

20 AWG (0.56 mm²)

Stranding: 7/28 (7 x 0.32 mm)
Insulation thickness: 0.016 (0.41 mm)

Part No.	Conductors	Nominal Diameter		Jacket Thickness	
		Inch	mm	Inch	mm
35152	2	0.235	5.97	0.032	0.81
35153	3	0.246	6.25	0.032	0.81
35154	4	0.264	6.71	0.032	0.81
35156	6	0.306	7.77	0.032	0.81
35158	8	0.328	8.33	0.032	0.81
35160	10	0.375	9.53	0.032	0.81
35160/15	15	0.417	10.59	0.032	0.81

18 AWG (0.81 mm²)

Stranding: 16/30 (16 x 0.25 mm)
Insulation thickness: 0.016 (0.41 mm)

Part No.	Conductors	Nominal Diameter		Jacket Thickness	
		Inch	mm	Inch	mm
35162	2	0.253	6.43	0.032	0.81
35162/1*	2	0.253	6.43	0.032	0.81
35163	3	0.265	6.73	0.032	0.81
35163/1*	3	0.265	6.73	0.032	0.81
35164	4	0.286	7.26	0.032	0.81
35166	6	0.333	8.46	0.032	0.81
35168	8	0.358	9.09	0.032	0.81
35170	10	0.411	10.44	0.032	0.81
35170/15	15	0.458	11.63	0.032	0.81

*Conductors color-coded per international standards: brown, blue, green/yellow.

16 AWG (1.23 mm²)

Stranding: 19/0.0117 (19 x 0.29 mm)
Insulation thickness: 0.016 (0.41 mm)

Part No.	Conductors	Nominal Diameter		Jacket Thickness	
		Inch	mm	Inch	mm
35172	2	0.277	7.04	0.032	0.81
35172/1*	2	0.277	7.04	0.032	0.81
35173	3	0.291	7.39	0.032	0.81
35173/1*	3	0.291	7.39	0.032	0.81
35174	4	0.315	8.00	0.032	0.81
35176	6	0.369	9.37	0.032	0.81
35178	8	0.398	10.11	0.032	0.81
35180	10	0.459	11.66	0.032	0.81
35180/15	15	0.513	13.03	0.032	0.81

*Conductors color-coded per international standards: brown, blue, green/yellow.



Xtra-Guard® 3

Direct Burial 300 V Foil Shield, Multipair

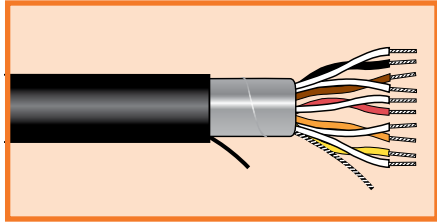

Operating Temperature

- -30°C to +80°C

Conductor Color Coding

- 24, 22 AWG: Chart B (page 528)
- 20, 18 AWG: Chart A (page 528)
- Nine jacket colors (black standard)
- Custom colors available

Materials

- Stranded tinned copper conductors
- Premium PVC insulation
- Specially formulated polyethylene jacket
- UV resistant
- Aluminum/polyester foil shield, with 25% overlap and foil facing inward
- Tinned copper drain wire sized the same as cable conductors
- Nylon ripcord

Availability

Made to order
1000 ft (305 m) minimum

FIT® Tubing Recommendations

- FIT-700: Bonding, thermoplastic adhesive lined, cross-linked polyolefin

24 AWG (0.23 mm²)

Stranding: 7/32 (7 x 0.20 mm)
Insulation thickness: 0.010 (0.25 mm)

Part No.	Pairs	Nominal Diameter		Jacket Thickness	
		Inch	mm	Inch	mm
35491	1	0.159	4.04	0.032	0.81
35492	2	0.215	5.46	0.032	0.81
35493	3	0.227	5.77	0.032	0.81
35494	4	0.246	6.25	0.032	0.81

22 AWG (0.35 mm²)

Stranding: 7/30 (7 x 0.25 mm)
Insulation thickness: 0.010 (0.25 mm)

Part No.	Pairs	Nominal Diameter		Jacket Thickness	
		Inch	mm	Inch	mm
35481	1	0.171	4.34	0.032	0.81
35482	2	0.235	5.97	0.032	0.81
35483	3	0.248	6.30	0.032	0.81
35484	4	0.269	6.83	0.032	0.81
35485	5	0.293	7.44	0.032	0.81

20 AWG (0.56 mm²)

Stranding: 7/28 (7 x 0.32 mm)
Insulation thickness: 0.016 (0.41 mm)

Part No.	Pairs	Nominal Diameter		Jacket Thickness	
		Inch	mm	Inch	mm
35452	2	0.301	7.65	0.032	0.81
35453	3	0.319	8.10	0.032	0.81

18 AWG (0.81 mm²)

Stranding: 16/30 (16 x 0.25 mm)
Insulation thickness: 0.016 (0.41 mm)

Part No.	Pairs	Nominal Diameter		Jacket Thickness	
		Inch	mm	Inch	mm
35372	2	0.330	8.38	0.032	0.81
35373	3	0.350	8.89	0.032	0.81
35376	6	0.462	11.73	0.032	0.81





Xtra-Guard® 3

Direct Burial

300 V Supra-Shield® Foil/Braid, Multipair

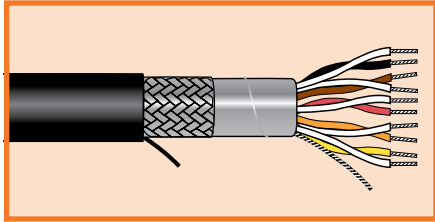

Operating Temperature

- -30°C to +80°C

Conductor Color Coding

- Chart B (page 528)
- Nine jacket colors (black standard)
- Custom colors available

Materials

- Stranded tinned copper conductors
- Premium PVC insulation
- Specially formulated polyethylene jacket
- UV resistant
- Supra-Shield foil + braid shield: Aluminum/polyester/aluminum foil with 25% overlap min. Tinned copper drain wire sized the same as conductors
- Tinned copper braid, 70% coverage min.
- Nylon ripcord

Availability

Made to order
1000 ft (305 m) minimum

FIT® Tubing Recommendations

- FIT-700: Bonding, thermoplastic adhesive lined, cross-linked polyolefin

24 AWG (0.23 mm²)

Stranding: 7/32 (7 x 0.20 mm)
Insulation thickness: 0.010 (0.25 mm)

Part No.	Pairs	Nominal Diameter		Jacket Thickness	
		Inch	mm	Inch	mm
35272	2	0.239	6.07	0.032	0.81

22 AWG (0.35 mm²)

Stranding: 7/30 (7 x 0.25 mm)
Insulation thickness: 0.010 (0.25 mm)

Part No.	Pairs	Nominal Diameter		Jacket Thickness	
		Inch	mm	Inch	mm
35121	1	0.195	4.95	0.032	0.081
35122	2	0.259	6.58	0.032	0.081
35123	3	0.272	6.91	0.032	0.081
35124	4	0.293	7.44	0.032	0.081
35125	5	0.317	8.05	0.032	0.081
35126	6	0.342	8.69	0.032	0.081
35129	9	0.393	9.98	0.032	0.081



Xtra-Guard® 4



Advanced Temperature and Chemical Performance



Features

- The preferred outdoor cable for advanced temperature and chemical performance
- Temperature range from -50°C to +125°C
- High-performance TPE insulation and jacket offering 3 times the low-temperature flexibility of conventional PVC
- Solvent and water resistant
- Fast, easy stripping of insulation and jacket
- Color-coded, tinned copper conductors
- 300 V and 600 V
- Unshielded, foil shielded, or Supra-Shield® foil/braid
- Outstanding ultraviolet light stability in all jacket colors
- Nylon ripcord for easy jacket stripping
- Approved by the US Mine Safety and Health Administration and The Pennsylvania Department of Environmental Protection
- Suitable for use in Class 1, Division 2 Locations under the applicable sections of the National Electric Code

- UL Types TC, PLTC, and WTTC
- CSA AWM I A/B II A/B FT1
- Passes UL 1685 Vertical Tray Flame Test

Applications

- Wood, paper, pulp, plant operations
- Mining instruments and controls
- Mass transit systems
- Military electronic applications
- Food and beverage plants
- Petrochemical process controls
- Arctic pipeline controls

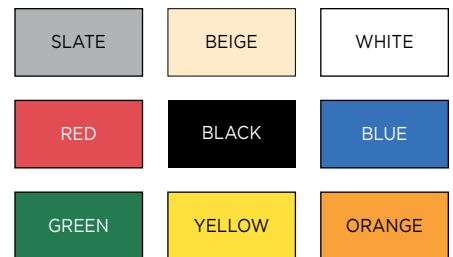

Xtra-Guard cables are available in a range of long-lasting colors for fast, easy identification, for safety reasons, and for matching the color of your system.

FIT® Tubing Recommendations

- FIT-600: highly flexible, cross-linked elastomer
- FIT-400: temperature/chemical resistant FEP

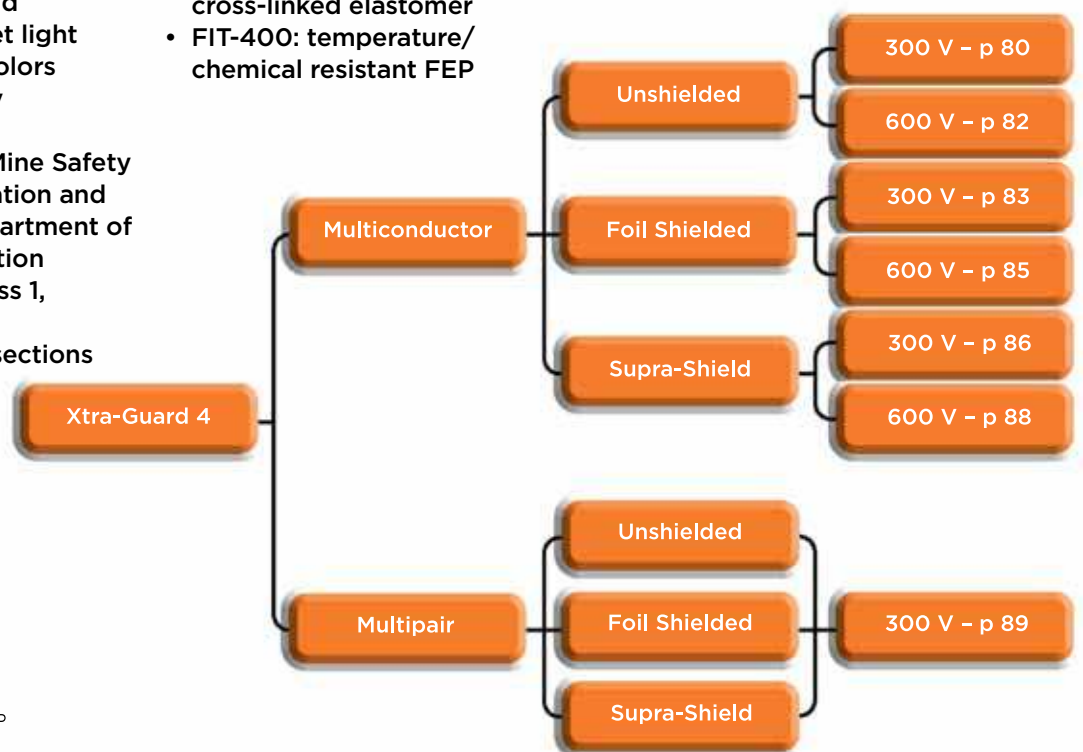

Xtra-Guard® 4



Advanced Temperature and Chemical Performance 300 V Unshielded, Multiconductor

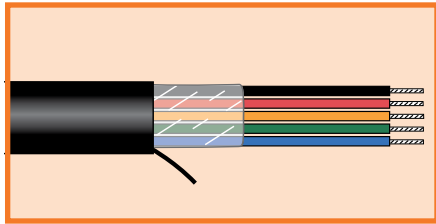

UL AWM 20237
UL PLTC*
CSA AWM I/II A/B FT1
MSHA P-07-KA070017-MSHA
NEC Class 1, Div 2 (22 & 20 AWG)

Operating Temperature

- -50°C to +125°C

Conductor Color Coding

- 24, 22 AWG: Chart E (page 532)
- 20, 18, 16 AWG: Chart D (page 531)
- Nine jacket colors (black standard)
- Custom colors available

Materials

- Stranded tinned copper conductors
- TPE insulation
- TPE jacket
- Nylon ripcord

Availability

Made to order
 1000 ft (305 m) minimum

FIT® Tubing Recommendations

- FIT-600: highly flexible, cross-linked elastomer
- FIT-400: temperature/chemical resistant FEP

24 AWG (0.23 mm²)*

Stranding: 7/32 (7 x 0.20 mm)
 Insulation thickness: 0.016 (0.41 mm)

Part No.	Conductors	Nominal Diameter		Jacket Thickness	
		Inch	mm	Inch	mm
45012	2	0.200	5.08	0.042	1.07
45013	3	0.209	5.31	0.042	1.07
45014	4	0.224	5.69	0.042	1.07
45016	6	0.257	6.53	0.042	1.07
45018	8	0.275	6.99	0.042	1.07
45020	10	0.312	7.92	0.042	1.07
45020/15	15	0.347	8.81	0.042	1.07
45020/20	20	0.383	9.73	0.042	1.07
45020/25	25	0.424	10.77	0.042	1.07

* UL AWM 20237, CSA AWM I/II A/B FT1 only

22 AWG (0.35 mm²)

Stranding: 7/30 (7 x 0.25 mm)
 Insulation thickness: 0.016 (0.41 mm)

Part No.	Conductors	Nominal Diameter		Jacket Thickness	
		Inch	mm	Inch	mm
45002	2	0.218	5.54	0.045	1.14
45003	3	0.228	5.79	0.045	1.14
45004	4	0.244	6.20	0.045	1.14
45006	6	0.281	7.14	0.045	1.14
45008	8	0.301	7.65	0.045	1.14
45010	10	0.342	8.69	0.045	1.14
45010/15	15	0.380	9.65	0.045	1.14
45010/20	20	0.441	11.20	0.055	1.40
45010/25	25	0.486	12.34	0.055	1.40

20 AWG (0.56 mm²)

Stranding: 7/28 (7 x 0.32 mm)
 Insulation thickness: 0.016 (0.41 mm)

Part No.	Conductors	Nominal Diameter		Jacket Thickness	
		Inch	mm	Inch	mm
45052	2	0.234	5.94	0.045	1.14
45053	3	0.245	6.22	0.045	1.14
45054	4	0.264	6.71	0.045	1.14
45056	6	0.306	7.77	0.045	1.14
45058	8	0.328	8.33	0.045	1.14
45060	10	0.374	9.50	0.045	1.14
45060/15	15	0.437	11.10	0.055	1.40
45060/20	20	0.483	12.27	0.055	1.40
45060/25	25	0.534	13.56	0.055	1.40





Xtra-Guard® 4

Advanced Temperature and Chemical Performance 300 V Unshielded, Multiconductor

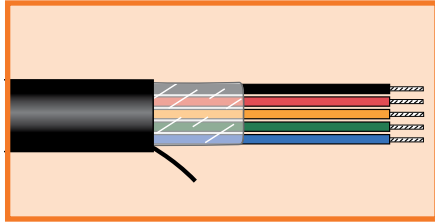

UL AWM 20237
UL PLTC
CSA AWM I/II A/B FT1
MSHA P-07-KA070017-MSHA
NEC Class 1, Div 2

Operating Temperature

- -50°C to +125°C

Conductor Color Coding

- 24, 22 AWG: Chart E (page 532)
- 20, 18, 16 AWG: Chart D (page 531)
- Nine jacket colors (black standard)
- Custom colors available

Materials

- Stranded tinned copper conductors
- TPE insulation
- TPE jacket
- Nylon ripcord

Availability

Made to order
 1000 ft (305 m) minimum

FIT® Tubing Recommendations

- FIT-600: highly flexible, cross-linked elastomer
- FIT-400: temperature/chemical resistant FEP

18 AWG (0.81 mm²)

Stranding: 16/30 (16 x 0.25 mm)
 Insulation thickness: 0.016 (0.41 mm)

Part No.	Conductors	Nominal Diameter		Jacket Thickness	
		Inch	mm	Inch	mm
45062	2	0.252	6.40	0.045	1.14
45062/1*	2	0.252	6.40	0.045	1.14
45063	3	0.264	6.71	0.045	1.14
45063/1*	3	0.264	6.71	0.045	1.14
45064	4	0.285	7.24	0.045	1.14
45066	6	0.333	8.46	0.045	1.14
45068	8	0.358	9.09	0.045	1.14
45070	10	0.430	10.92	0.055	1.40
45070/15	15	0.479	12.17	0.055	1.40
45070/20	20	0.530	13.46	0.055	1.40
45070/25	25	0.588	14.94	0.055	1.40

*Conductors color-coded per international standards: brown, blue, green/yellow.

16 AWG (1.23 mm²)

Stranding: 19/0.0117 (19 x 0.29 mm)
 Insulation thickness: 0.016 (0.41 mm)

Part No.	Conductors	Nominal Diameter		Jacket Thickness	
		Inch	mm	Inch	mm
45072	2	0.276	7.01	0.045	1.14
45072/1*	2	0.276	7.01	0.045	1.14
45073	3	0.290	7.37	0.045	1.14
45073/1*	3	0.290	7.37	0.045	1.14
45074	4	0.314	7.98	0.045	1.14
45076	6	0.369	9.37	0.045	1.14
45078	8	0.418	10.62	0.055	1.40
45080	10	0.478	12.14	0.055	1.40
45080/15	15	0.534	13.56	0.055	1.40
45080/20	20	0.593	15.06	0.055	1.40
45080/25	25	0.680	17.27	0.055	1.40

*Conductors color-coded per international standards: brown, blue, green/yellow.



Xtra-Guard® 4



Advanced Temperature and Chemical Performance 600 V Unshielded, Multiconductor

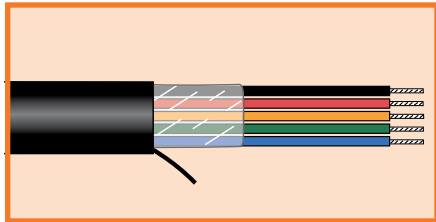

UL AWM 20238
UL TC, WTTC
CSA AWM I/II A/B FT1
MSHA P-07-KA070017-MSHA
NEC Class 1, Div 2

Operating Temperature

- -50°C to +125°C

Conductor Color Coding

- Chart E (page 532)
- Nine jacket colors (black standard)
- Custom colors available

Materials

- Stranded tinned copper conductors
- TPE insulation
- TPE jacket
- Nylon ripcord

Availability

Made to order
1000 ft (305 m) minimum

FIT® Tubing Recommendations

- FIT-600: highly flexible, cross-linked elastomer
- FIT-400: temperature/chemical resistant FEP

18 AWG (0.81 mm²)

Stranding: 16/30 (16 x 0.25 mm)
Insulation thickness: 0.032 (0.81 mm)

Part No.	Conductors	Nominal Diameter		Jacket Thickness	
		Inch	mm	Inch	mm
45422	2	0.336	8.53	0.055	1.40
45423	3	0.353	8.97	0.055	1.40
45424	4	0.383	9.73	0.055	1.40
45425	5	0.416	10.57	0.055	1.40
45427	7	0.450	11.43	0.055	1.40
45429	9	0.519	13.18	0.055	1.40

16 AWG (1.23 mm²)

Stranding: 19/0.0117 (19 x 0.29 mm)
Insulation thickness: 0.032 (0.81 mm)

Part No.	Conductors	Nominal Diameter		Jacket Thickness	
		Inch	mm	Inch	mm
45432	2	0.360	9.14	0.055	1.40
45433	3	0.379	9.63	0.055	1.40
45434	4	0.412	10.46	0.055	1.40
45435	5	0.448	11.38	0.055	1.40
45437	7	0.486	12.34	0.055	1.40
45439	9	0.583	14.81	0.065	1.65

14 AWG (2.08 mm²)

Stranding: 41/30 (41 x 0.25 mm)
Insulation thickness: 0.032 (0.81 mm)

Part No.	Conductors	Nominal Diameter		Jacket Thickness	
		Inch	mm	Inch	mm
45442	2	0.390	9.91	0.055	1.40
45443	3	0.412	10.46	0.055	1.40
45444	4	0.448	11.38	0.055	1.40
45445	5	0.489	12.42	0.055	1.40
45447	7	0.551	14.00	0.065	1.65



Xtra-Guard® 4



Advanced Temperature and Chemical Performance 300 V Foil Shielded, Multiconductor

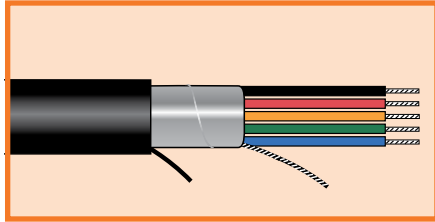

UL AWM 20237
UL PLTC*
CSA AWM I/II A/B FT1
MSHA P-07-KA070017-MSHA
NEC Class 1, Div 2 (22 & 20 AWG)

Operating Temperature

- 50°C to +125°C

Conductor Color Coding

- 24, 22 AWG: Chart E (page 532)
- 20, 18, 16 AWG: Chart D (page 531)
- Nine jacket colors (black standard)
- Custom colors available

Materials

- Stranded tinned copper conductors
- TPE insulation
- TPE jacket
- Aluminum/polyester foil shield, with 25% overlap and foil facing inward
- Tinned copper drain wire sized the same as cable conductors
- Nylon ripcord

Availability

Made to order
 1000 ft (305 m) minimum

FIT® Tubing Recommendations

- FIT-600: highly flexible, cross-linked elastomer
- FIT-400: temperature/chemical resistant FEP

24 AWG (0.23 mm²)

Stranding: 7/32 (7 x 0.20 mm)
 Insulation thickness: 0.016 (0.41 mm)

Part No.	Conductors	Nominal Diameter		Jacket Thickness	
		Inch	mm	Inch	mm
45092	2	0.204	5.18	0.042	1.07
45093	3	0.213	5.41	0.042	1.07
45094	4	0.228	5.79	0.042	1.07
45096	6	0.261	6.63	0.042	1.07
45098	8	0.279	7.09	0.042	1.07
45100	10	0.316	8.03	0.042	1.07
45100/15	15	0.351	8.92	0.042	1.07
45100/20	20	0.387	9.83	0.042	1.07
45100/25	25	0.428	10.87	0.042	1.07

* UL AWM 20237, CSA AWM I/II A/B FT1 only

22 AWG (0.35 mm²)

Stranding: 7/30 (7 x 0.25 mm)
 Insulation thickness: 0.016 (0.41 mm)

Part No.	Conductors	Nominal Diameter		Jacket Thickness	
		Inch	mm	Inch	mm
45192	2	0.222	5.64	0.045	1.14
45193	3	0.232	5.89	0.045	1.14
45194	4	0.248	6.30	0.045	1.14
45196	6	0.285	7.24	0.045	1.14
45198	8	0.305	7.75	0.045	1.14
45199/10	10	0.346	8.79	0.045	1.14
45199/15	15	0.404	10.26	0.055	1.40
45199/20	20	0.445	11.30	0.055	1.40
45199/25	25	0.490	12.45	0.055	1.40

20 AWG (0.56 mm²)

Stranding: 7/28 (7 x 0.32 mm)
 Insulation thickness: 0.016 (0.41 mm)

Part No.	Conductors	Nominal Diameter		Jacket Thickness	
		Inch	mm	Inch	mm
45462	2	0.238	6.05	0.045	1.14
45463	3	0.249	6.32	0.045	1.14
45464	4	0.268	6.81	0.045	1.14
45466	6	0.310	7.87	0.045	1.14
45468	8	0.332	8.43	0.045	1.14
45470	10	0.378	9.60	0.045	1.14
45470/15	15	0.441	11.20	0.055	1.40
45470/20	20	0.487	12.37	0.055	1.40
45470/25	25	0.538	13.67	0.055	1.40
45470/40	40	0.650	16.51	0.065	1.65



Xtra-Guard® 4



Advanced Temperature and Chemical Performance 300 V Foil Shielded, Multiconductor

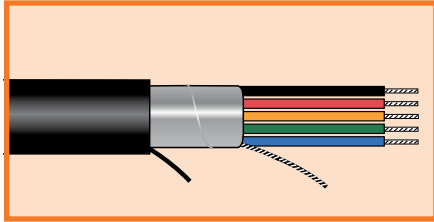

UL AWM 20237
UL PLTC
CSA AWM I/II A/B FT1
MSHA P-07-KA070017-MSHA
NEC Class 1, Div 2

Operating Temperature

- -50°C to +125°C

Conductor Color Coding

- 24, 22 AWG: Chart E (page 532)
- 20, 18, 16 AWG: Chart D (page 531)
- Nine jacket colors (black standard)
- Custom colors available

Materials

- Stranded tinned copper conductors
- TPE insulation
- TPE jacket
- Aluminum/polyester foil shield, with 25% overlap and foil facing inward
- Tinned copper drain wire sized the same as cable conductors
- Nylon ripcord

Availability

Made to order
1000 ft (305 m) minimum

FIT® Tubing Recommendations

- FIT-600: highly flexible, cross-linked elastomer
- FIT-400: temperature/chemical resistant FEP

18 AWG (0.81 mm²)

Stranding: 16/30 (16 x 0.25 mm)
Insulation thickness: 0.016 (0.41 mm)

Part No.	Conductors	Nominal Diameter		Jacket Thickness	
		Inch	mm	Inch	mm
45382	2	0.256	6.50	0.045	1.14
45382/1*	2	0.256	6.50	0.045	1.14
45383	3	0.268	6.81	0.045	1.14
45383/1*	3	0.268	6.81	0.045	1.14
45384	4	0.289	7.34	0.045	1.14
45386	6	0.337	8.56	0.045	1.14
45388	8	0.362	9.19	0.045	1.14
45390	10	0.434	11.02	0.055	1.40
45390/15	15	0.483	12.27	0.055	1.40
45390/20	20	0.534	13.56	0.055	1.40
45390/25	25	0.592	15.04	0.055	1.40
45390/30	30	0.645	16.38	0.065	1.65

*Conductors color-coded per international standards: brown, blue, green/yellow.

16 AWG (1.23 mm²)

Stranding: 19/0.0117 (19 x 0.29 mm)
Insulation thickness: 0.016 (0.41 mm)

Part No.	Conductors	Nominal Diameter		Jacket Thickness	
		Inch	mm	Inch	mm
45362	2	0.280	7.11	0.045	1.14
45362/1*	2	0.280	7.11	0.045	1.14
45363	3	0.294	7.47	0.045	1.14
45363/1*	3	0.294	7.47	0.045	1.14
45364	4	0.318	8.08	0.045	1.14
45366	6	0.373	9.47	0.045	1.14
45368	8	0.422	10.72	0.045	1.14
45370	10	0.482	12.24	0.055	1.40
45370/15	15	0.538	13.67	0.055	1.40
45370/20	20	0.597	15.16	0.055	1.40
45370/25	25	0.684	17.37	0.065	1.65

*Conductors color-coded per international standards: brown, blue, green/yellow.



Xtra-Guard® 4



Advanced Temperature and Chemical Performance 600 V Foil Shielded, Multiconductor

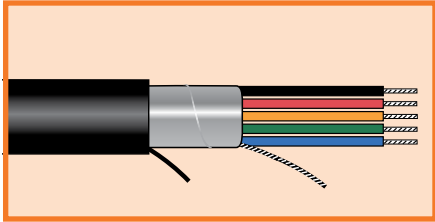

UL AWM 20238
UL TC, WTTC
CSA AWM I/II A/B FT1
MSHA P-07-KA070017-MSHA
NEC Class 1, Div 2

Operating Temperature

- -50°C to +125°C

Conductor Color Coding

- Chart E (page 532)
- Nine jacket colors (black standard)
- Custom colors available

Materials

- Stranded tinned copper conductors
- TPE insulation
- TPE jacket
- Aluminum/polyester foil shield, with 25% overlap and foil facing inward
- Tinned copper drain wire sized the same as cable conductors
- Nylon ripcord

Availability

Made to order
 1000 ft (305 m) minimum

FIT® Tubing Recommendations

- FIT-600: highly flexible, cross-linked elastomer
- FIT-400: temperature/chemical resistant FEP

18 AWG (0.81 mm²)

Stranding: 16/30 (16 x 0.25 mm)
 Insulation thickness: 0.032 (0.81 mm)

Part No.	Conductors	Nominal Diameter		Jacket Thickness	
		Inch	mm	Inch	mm
45430/2	2	0.340	8.64	0.055	1.40
45430/3	3	0.357	9.07	0.055	1.40
45430/4	4	0.387	9.83	0.055	1.40
45430/5	5	0.420	10.67	0.055	1.40
45430/7	7	0.454	11.53	0.055	1.40
45430/9	9	0.543	13.79	0.055	1.40
45430/12	12	0.599	15.21	0.065	1.65

16 AWG (1.23 mm²)

Stranding: 19/0.0117 (19 x 0.29 mm)
 Insulation thickness: 0.032 (0.81 mm)

Part No.	Conductors	Nominal Diameter		Jacket Thickness	
		Inch	mm	Inch	mm
45440/2	2	0.364	9.25	0.055	1.40
45440/3	3	0.383	9.73	0.055	1.40
45440/5	5	0.452	11.48	0.055	1.40
45440/7	7	0.490	12.45	0.055	1.40
45440/9	9	0.587	14.91	0.065	1.65
45440/12	12	0.649	16.48	0.065	1.65

14 AWG (2.08 mm²)

Stranding: 41/30 (41 x 0.25 mm)
 Insulation thickness: 0.032 (0.81 mm)

Part No.	Conductors	Nominal Diameter		Jacket Thickness	
		Inch	mm	Inch	mm
45450/2	2	0.394	10.01	0.055	1.40
45450/3	3	0.416	10.57	0.055	1.40
45450/5	5	0.493	12.52	0.055	1.40
45450/7	7	0.555	14.10	0.065	1.65
45450/15	15	0.775	19.69	0.065	1.65



Xtra-Guard® 4



Advanced Temperature and Chemical Performance 300 V Supra-Shield® Foil/Braid, Multiconductor

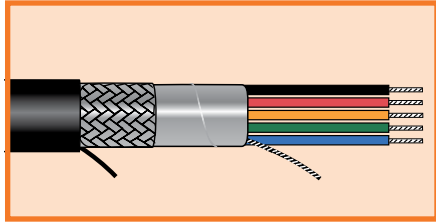

UL AWM 20237
UL PLTC
CSA AWM I/II A/B FT1
MSHA P-07-KA070017-MSHA
NEC Class 1, Div 2 (22 & 20 AWG)

Operating Temperature

- 50°C to +125°C

Conductor Color Coding

- 24, 22 AWG: Chart E (page 532)
- 20, 18, 16 AWG: Chart D (page 531)
- Nine jacket colors (black standard)
- Custom colors available

Materials

- Stranded tinned copper conductors
- TPE insulation
- TPE jacket
- Supra-Shield foil + braid shield: Aluminum/polyester/aluminum foil with 25% overlap min. Tinned copper drain wire sized the same as conductors
- Tinned copper braid, 70% coverage min.
- Nylon ripcord

Availability

Made to order
1000 ft (305 m) minimum

FIT® Tubing Recommendations

- FIT-600: highly flexible, cross-linked elastomer
- FIT-400: temperature/chemical resistant FEP

24 AWG (0.23 mm²)

Stranding: 7/32 (7 x 0.20 mm)
Insulation thickness: 0.016 (0.41 mm)

Part No.	Conductors	Nominal Diameter		Jacket Thickness	
		Inch	mm	Inch	mm
45112	2	0.228	5.79	0.042	1.07
45113	3	0.237	6.02	0.042	1.07
45114	4	0.252	6.40	0.042	1.07
45116	6	0.285	7.24	0.042	1.07
45118	8	0.303	7.70	0.042	1.07
45120	10	0.340	8.64	0.042	1.07
45120/15	15	0.375	9.53	0.042	1.07
45120/20	20	0.411	10.44	0.042	1.07
45120/25	25	0.452	11.48	0.042	1.07

* UL AWM 20237, CSA AWM I/II A/B FT1 only

22 AWG (0.35 mm²)

Stranding: 7/30 (7 x 0.25 mm)
Insulation thickness: 0.016 (0.41 mm)

Part No.	Conductors	Nominal Diameter		Jacket Thickness	
		Inch	mm	Inch	mm
45102	2	0.246	6.25	0.045	1.14
45103	3	0.256	6.50	0.045	1.14
45104	4	0.272	6.91	0.045	1.14
45106	6	0.309	7.85	0.045	1.14
45108	8	0.329	8.36	0.045	1.14
45110	10	0.370	9.40	0.045	1.14
45110/15	15	0.428	10.87	0.055	1.40
45110/20	20	0.469	11.91	0.055	1.40
45110/25	25	0.514	13.06	0.055	1.40

20 AWG (0.56 mm²)

Stranding: 7/28 (7 x 0.32 mm)
Insulation thickness: 0.016 (0.41 mm)

Part No.	Conductors	Nominal Diameter		Jacket Thickness	
		Inch	mm	Inch	mm
45152	2	0.262	6.65	0.045	1.14
45153	3	0.273	6.93	0.045	1.14
45154	4	0.292	7.42	0.045	1.14
45156	6	0.334	8.48	0.045	1.14
45158	8	.0356	9.04	0.045	1.14
45160	10	0.422	10.72	0.055	1.40
45160/15	15	0.465	11.81	0.055	1.40
45160/20	20	0.511	12.98	0.055	1.40
45160/25	25	0.562	14.27	0.055	1.40





Xtra-Guard® 4

Advanced Temperature and Chemical Performance 300 V Supra-Shield® Foil/Braid, Multiconductor

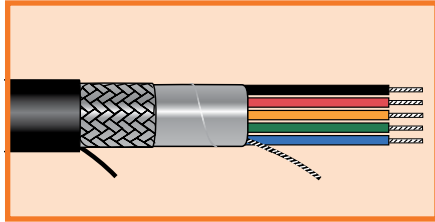

UL AWM 20237
UL PLTC
CSA AWM I/II A/B FT1
MSHA P-07-KA070017-MSHA
NEC Class 1, Div 2

Operating Temperature

- -50°C to +125°C

Conductor Color Coding

- 24, 22 AWG: Chart E (page 532)
- 20, 18, 16 AWG: Chart D (page 531)
- Nine jacket colors (black standard)
- Custom colors available

Materials

- Stranded tinned copper conductors
- TPE insulation
- TPE jacket
- Supra-Shield foil + braid shield: Aluminum/polyester/aluminum foil with 25% overlap min. Tinned copper drain wire sized the same as conductors
- Tinned copper braid, 70% coverage min.
- Nylon ripcord

Availability

Made to order
 1000 ft (305 m) minimum

FIT® Tubing Recommendations

- FIT-600: highly flexible, cross-linked elastomer
- FIT-400: temperature/chemical resistant FEP

18 AWG (0.81 mm²)

Stranding: 16/30 (16 x 0.25 mm)
 Insulation thickness: 0.016 (0.41 mm)

Part No.	Conductors	Nominal Diameter		Jacket Thickness	
		Inch	mm	Inch	mm
45162	2	0.280	7.11	0.045	1.14
45162/1*	2	0.280	7.11	0.045	1.14
45163	3	0.292	7.42	0.045	1.14
45163/1*	3	0.292	7.42	0.045	1.14
45164	4	0.313	7.95	0.045	1.14
45166	6	0.361	9.17	0.045	1.14
45168	8	0.406	10.31	0.045	1.14
45170	10	0.458	11.63	0.055	1.40
45170/15	15	0.507	12.88	0.055	1.40
45170/20	20	0.558	14.17	0.055	1.40
45170/25	25	0.636	16.15	0.065	1.65
45170/30	30	0.675	17.15	0.065	1.65

*Conductors color-coded per international standards: brown, blue, green/yellow.

16 AWG (1.23 mm²)

Stranding: 19/0.0117 (19 x 0.29 mm)
 Insulation thickness: 0.016 (0.41 mm)

Part No.	Conductors	Nominal Diameter		Jacket Thickness	
		Inch	mm	Inch	mm
45172	2	0.304	7.72	0.045	1.14
45172/1*	2	0.304	7.72	0.045	1.14
45173	3	0.318	8.08	0.045	1.14
45173/1*	3	0.318	8.08	0.045	1.14
45174	4	0.342	8.69	0.045	1.14
45176	6	0.417	10.59	0.055	1.40
45178	8	0.446	11.33	0.055	1.40
45180	10	0.506	12.85	0.055	1.40
45180/15	15	0.562	14.27	0.055	1.40
45180/20	20	0.641	16.28	0.065	1.65
45180/25	25	0.714	18.14	0.065	1.65

*Conductors color-coded per international standards: brown, blue, green/yellow.





Xtra-Guard® 4

Advanced Temperature and Chemical Performance 600 V Supra-Shield® Foil/Braid, Multiconductor

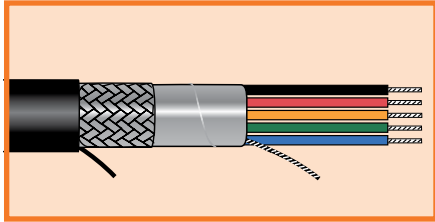

UL AWM 20238
UL TC, WTTC
CSA AWM I/II A/B FT1
MSHA P-07-KA070017-MSHA
NEC Class 1, Div 2

Operating Temperature

- -50°C to +125°C

Conductor Color Coding

- Chart E (page 532)
- Nine jacket colors (black standard)
- Custom colors available

Materials

- Stranded tinned copper conductors
- TPE insulation
- TPE jacket
- Supra-Shield foil + braid shield: Aluminum/polyester/aluminum foil with 25% overlap min. Tinned copper drain wire sized the same as conductors
- Tinned copper braid, 70% coverage min.
- Nylon ripcord

Availability

Made to order
1000 ft (305 m) minimum

FIT® Tubing Recommendations

- FIT-600: highly flexible, cross-linked elastomer
- FIT-400: temperature/chemical resistant FEP

18 AWG (0.81 mm²)

Stranding: 16/30 (16 x 0.25 mm)
Insulation thickness: 0.032 (0.81 mm)

Part No.	Conductors	Nominal Diameter		Jacket Thickness	
		Inch	mm	Inch	mm
45522	2	0.364	9.25	0.055	1.40
45523	3	0.381	9.68	0.055	1.40
45524	4	0.411	10.44	0.055	1.40
45525	5	0.444	11.28	0.055	1.40
45527	7	0.478	12.14	0.055	1.40
45529	9	0.567	14.40	0.065	1.65
45529/12	12	0.623	15.82	0.065	1.65

16 AWG (1.23 mm²)

Stranding: 19/0.0117 (19 x 0.29 mm)
Insulation thickness: 0.032 (0.81 mm)

Part No.	Conductors	Nominal Diameter		Jacket Thickness	
		Inch	mm	Inch	mm
45532	2	0.388	9.86	0.055	1.40
45533	3	0.407	10.34	0.055	1.40
45534	4	0.440	11.18	0.055	1.40
45535	5	0.476	12.09	0.055	1.40
45537	7	0.514	13.06	0.055	1.40
45539	9	0.611	15.52	0.065	1.65
45539/12	12	0.679	17.25	0.065	1.65

14 AWG (2.08 mm²)

Stranding: 41/30 (41 x 0.25 mm)
Insulation thickness: 0.032 (0.81 mm)

Part No.	Conductors	Nominal Diameter		Jacket Thickness	
		Inch	mm	Inch	mm
45542	2	0.418	10.62	0.055	1.40
45543	3	0.440	11.18	0.055	1.40
45544	4	0.476	12.09	0.055	1.40
45545	5	0.517	13.13	0.055	1.40
45547	7	0.579	14.71	0.065	1.65
45549	9	0.672	17.07	0.065	1.65





Xtra-Guard® 4

Advanced Temperature and Chemical Performance 300 V Unshielded, Multipair

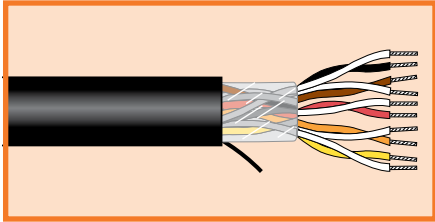

18 AWG (0.81 mm ²)					
Stranding: 16/30 (16 x 0.25 mm) Insulation thickness: 0.016 (0.41 mm)					
Part No.	Pairs	Nominal Diameter		Jacket Thickness	
		Inch	mm	Inch	mm
45031	1	0.252	6.40	0.045	1.14
45032	2	0.353	8.97	0.045	1.14

UL AWM 20237
UL PLTC
CSA AWM I/II A/B FT1
MSHA P-07-KA070017-MSHA
NEC Class 1, Div 2

Operating Temperature

- -50°C to +125°C

Conductor Color Coding

- Chart B (page 528)
- Nine jacket colors (black standard)
- Custom colors available

Materials

- Stranded tinned copper conductors
- TPE insulation
- TPE jacket
- Nylon ripcord

Availability

Made to order
 1000 ft (305 m) minimum

FIT® Tubing Recommendations

- FIT-600: highly flexible, cross-linked elastomer
- FIT-400: temperature/chemical resistant FEP



Xtra-Guard® 4



Advanced Temperature and Chemical Performance 300 V Foil Shield, Multipair

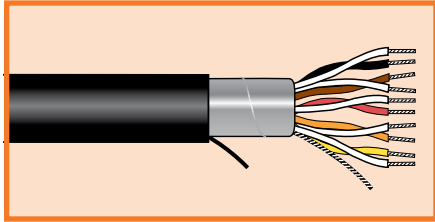

UL AWM 20237
UL PLTC
CSA AWM I/II A/B FT1
MSHA P-07-KA070017-MSHA
NEC Class 1, Div 2 (22 AWG)

Operating Temperature

- -50°C to +125°C

Conductor Color Coding

- Chart B (page 528)
- Nine jacket colors (black standard)
- Custom colors available

Materials

- Stranded tinned copper conductors
- TPE insulation
- TPE jacket
- Aluminum/polyester foil shield, with 25% overlap and foil facing inward
- Tinned copper drain wire sized the same as cable conductors
- Nylon ripcord

Availability

Made to order
 1000 ft (305 m) minimum

FIT® Tubing Recommendations

- FIT-600: highly flexible, cross-linked elastomer
- FIT-400: temperature/chemical resistant FEP

24 AWG (0.23 mm²)

Stranding: 7/32 (7 x 0.20 mm)
 Insulation thickness: 0.016 (0.41 mm)

Part No.	Pairs	Nominal Diameter		Jacket Thickness	
		Inch	mm	Inch	mm
45491	1	0.204	5.18	0.042	1.07
45492	2	0.276	7.01	0.042	1.07
45493	3	0.290	7.37	0.042	1.07
45494	4	0.314	7.98	0.042	1.07
45495	5	0.341	8.66	0.042	1.07
45496	6	0.370	9.40	0.042	1.07
45499	9	0.428	10.87	0.042	1.07
45499/11	11	0.459	11.66	0.042	1.07
45499/15	15	0.516	13.11	0.042	1.07
45499/27	27	0.679	17.25	0.053	1.35

* UL AWM 20237, CSA AWM I/II A/B FT1 only

22 AWG (0.35 mm²)

Stranding: 7/30 (7 x 0.25 mm)
 Insulation thickness: 0.016 (0.41 mm)

Part No.	Pairs	Nominal Diameter		Jacket Thickness	
		Inch	mm	Inch	mm
45481	1	0.222	5.64	0.045	1.14
45482	2	0.301	7.65	0.045	1.14
45483	3	0.317	8.05	0.045	1.14
45484	4	0.344	8.74	0.045	1.14
45485	5	0.374	9.50	0.045	1.14
45486	6	0.425	10.80	0.055	1.40
45489	9	0.489	12.42	0.055	1.40
45489/11	11	0.525	13.34	0.055	1.40
45489/15	15	0.588	14.94	0.055	1.40





Xtra-Guard® 4

Advanced Temperature and Chemical Performance 300 V Foil Shield, Multipair

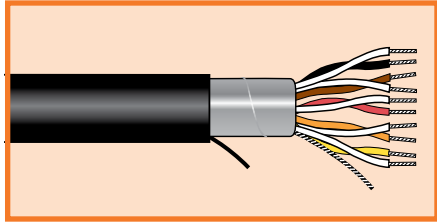

UL AWM 20237
UL PLTC
CSA AWM I/II A/B FT1
MSHA P-07-KA070017-MSHA
NEC Class 1, Div 2 (22 AWG)

Operating Temperature

- -50°C to +125°C

Conductor Color Coding

- Chart B (page 528)
- Nine jacket colors (black standard)
- Custom colors available

Materials

- Stranded tinned copper conductors
- TPE insulation
- TPE jacket
- Aluminum/polyester foil shield, with 25% overlap and foil facing inward
- Tinned copper drain wire sized the same as cable conductors
- Nylon ripcord

Availability

Made to order
 1000 ft (305 m) minimum

FIT® Tubing Recommendations

- FIT-600: highly flexible, cross-linked elastomer
- FIT-400: temperature/chemical resistant FEP

20 AWG (0.56 mm²)

Stranding: 7/28 (7 x 0.32 mm)
 Insulation thickness: 0.016 (0.41 mm)

Part No.	Pairs	Nominal Diameter		Jacket Thickness	
		Inch	mm	Inch	mm
45451	1	0.238	6.05	0.045	1.14
45452	2	0.328	8.33	0.045	1.14
45453	3	0.346	8.79	0.045	1.14
45454	4	0.376	9.55	0.045	1.14
45455	5	0.430	10.92	0.055	1.40
45456	6	0.465	11.81	0.055	1.40
45459	9	0.537	13.64	0.055	1.40
45459/11	11	0.577	14.66	0.055	1.40
45459/15	15	0.668	16.97	0.065	1.65
45459/19	19	0.713	18.11	0.065	1.65
45459/27	27	0.885	22.48	0.065	1.65

18 AWG (0.81 mm²)

Stranding: 16/30 (16 x 0.25 mm)
 Insulation thickness: 0.016 (0.41 mm)

Part No.	Pairs	Nominal Diameter		Jacket Thickness	
		Inch	mm	Inch	mm
45371	1	0.256	6.50	0.045	1.14
45372	2	0.357	9.07	0.045	1.14
45373	3	0.378	9.60	0.045	1.14
45374	4	0.432	10.97	0.055	1.40
45375	5	0.470	11.94	0.055	1.40
45376	6	0.510	12.95	0.055	1.40
45379	9	0.591	15.01	0.055	1.40
45379/11	11	0.656	16.66	0.065	1.65
45379/15	15	0.736	18.69	0.065	1.65
45379/19	19	0.787	19.99	0.065	1.65



Xtra-Guard® 4



Advanced Temperature and Chemical Performance 300 V Supra-Shield® Foil/Braid, Multipair

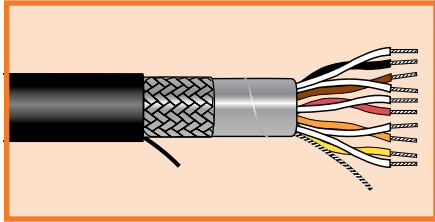

UL AWM 20237
UL PLTC
CSA AWM I/II A/B FT1
MSHA P-07-KA070017-MSHA
NEC Class 1, Div 2 (22 AWG)

Operating Temperature

- -50°C to +125°C

Conductor Color Coding

- Chart B (page 528)
- Nine jacket colors (black standard)
- Custom colors available

Materials

- Stranded tinned copper conductors
- TPE insulation
- TPE jacket
- Supra-Shield foil + braid shield: Aluminum/polyester/aluminum foil with 25% overlap min. Tinned copper drain wire sized the same as conductors
- Tinned copper braid, 70% coverage min.
- Nylon ripcord

Availability

Made to order
1000 ft (305 m) minimum

FIT® Tubing Recommendations

- FIT-600: highly flexible, cross-linked elastomer
- FIT-400: temperature/chemical resistant FEP

24 AWG (0.23 mm²)

Stranding: 7/32 (7 x 0.20 mm)
Insulation thickness: 0.016 (0.41 mm)

Part No.	Pairs	Nominal Diameter		Jacket Thickness	
		Inch	mm	Inch	mm
45271	1	0.228	5.79	0.042	1.07
45272	2	0.300	7.62	0.042	1.07
45273	3	0.314	7.98	0.042	1.07
45274	4	0.338	8.59	0.042	1.07
45275	5	0.365	9.27	0.042	1.07
45276	6	0.394	10.01	0.042	1.07
45279	9	0.452	11.48	0.042	1.07
45279/11	11	0.483	12.27	0.042	1.07
45279/15	15	0.540	13.72	0.042	1.07
45279/19	19	0.598	15.19	0.053	1.35

* UL AWM 20237, CSA AWM I/II A/B FT1 only

22 AWG (0.35 mm²)

Stranding: 7/30 (7 x 0.25 mm)
Insulation thickness: 0.016 (0.41 mm)

Part No.	Pairs	Nominal Diameter		Jacket Thickness	
		Inch	mm	Inch	mm
45121	1	0.246	6.25	0.045	1.14
45122	2	0.325	8.26	0.045	1.14
45123	3	0.341	8.66	0.045	1.14
45124	4	0.368	9.35	0.045	1.14
45125	5	0.418	10.62	0.055	1.40
45126	6	0.449	11.40	0.055	1.40
45129	9	0.513	13.03	0.055	1.40
45129/11	11	0.549	13.94	0.055	1.40
45129/15	15	0.632	16.05	0.065	1.65
45129/19	19	0.677	17.20	0.065	1.65





Xtra-Guard® 4

Advanced Temperature and Chemical Performance
300 V Supra-Shield® Foil/Braid, Multipair

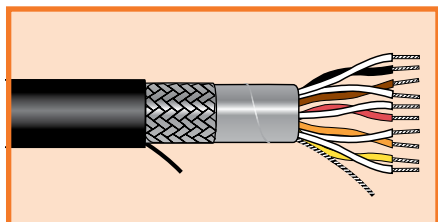

UL AWM 20237
UL PLTC
CSA AWM I/II A/B FT1
MSHA P-07-KA070017-MSHA
NEC Class 1, Div 2 (22 AWG)

Operating Temperature

- -50°C to +125°C

Conductor Color Coding

- Chart B (page 528)
- Nine jacket colors (black standard)
- Custom colors available

Materials

- Stranded tinned copper conductors
- TPE insulation
- TPE jacket
- Supra-Shield foil + braid shield: Aluminum/polyester/aluminum foil with 25% overlap min. Tinned copper drain wire sized the same as conductors
- Tinned copper braid, 70% coverage min.
- Nylon ripcord

Availability

Made to order
1000 ft (305 m) minimum

FIT® Tubing Recommendations

- FIT-600: highly flexible, cross-linked elastomer
- FIT-400: temperature/chemical resistant FEP

20 AWG (0.56 mm²)

Stranding: 7/28 (7 x 0.32 mm)
Insulation thickness: 0.016 (0.41 mm)

Part No.	Pairs	Nominal Diameter		Jacket Thickness	
		Inch	mm	Inch	mm
45291	1	0.262	6.65	0.045	1.14
45292	2	0.352	8.94	0.045	1.14
45293	3	0.370	9.40	0.045	1.14
45294	4	0.420	10.67	0.055	1.40
45295	5	0.454	11.53	0.055	1.40
45296	6	0.489	12.42	0.055	1.40
45299	9	0.561	14.25	0.055	1.40
45299/11	11	0.621	15.77	0.065	1.65
45299/15	15	0.698	17.73	0.065	1.65

18 AWG (0.81 mm²)

Stranding: 16/30 (16 x 0.25 mm)
Insulation thickness: 0.016 (0.41 mm)

Part No.	Pairs	Nominal Diameter		Jacket thickness	
		Inch	mm	Inch	mm
45131	1	0.280	7.11	0.045	1.14
45132	2	0.381	9.68	0.045	1.14
45133	3	0.422	10.72	0.055	1.40
45134	4	0.456	11.58	0.055	1.40
45135	5	0.494	12.55	0.055	1.40
45136	6	0.534	13.56	0.055	1.40
45139	9	0.635	16.13	0.065	1.65
45139/11	11	0.686	17.42	0.065	1.65
45139/15	15	0.766	19.46	0.065	1.65



Xtra-Guard® 5

Maximum Temperature and Chemical Performance



Features

- The preferred cable for unsurpassed maximum temperature and chemical performance
- Temperature range from -80°C to +200°C
- UL, CSA listed
- 100% impervious to all chemicals, solvents, acids, fuels, and water
- Suitable for Class 1 cleanrooms
- FDA food/medical grade (sterilizable)
- Low-friction FEP jacket for easy routing
- Fast, easy stripping of insulation and jacket
- Color-coded, tinned copper conductors
- 300 V
- Unshielded, foil shielded, or Supra-Shield® foil/braid
- Outstanding ultraviolet light stability in all jacket colors
- Aramid fiber ripcord for easy jacket stripping
- Excellent flame resistance and low smoke generation: Passes NFPA 262-2007

Applications

- Food and beverage wash-down
- Cleanroom environments
- Food/medical-grade applications
- Turbine generators
- Chemical processing
- Military electronics
- Mining instrumentation

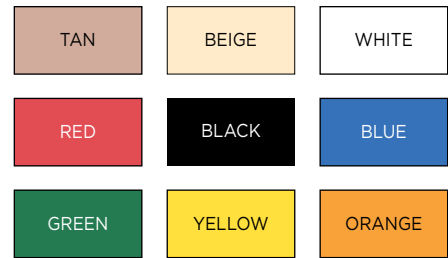

FIT® Tubing Recommendations

- FIT-650: Chemical/temperature resistant flexible fluoroelastomer
- FIT-400: Temperature/chemical resistant FEP

Xtra-Guard 5 cables are available in a range of long-lasting tints for fast, easy identification, for safety reasons, and for matching the color of your system.

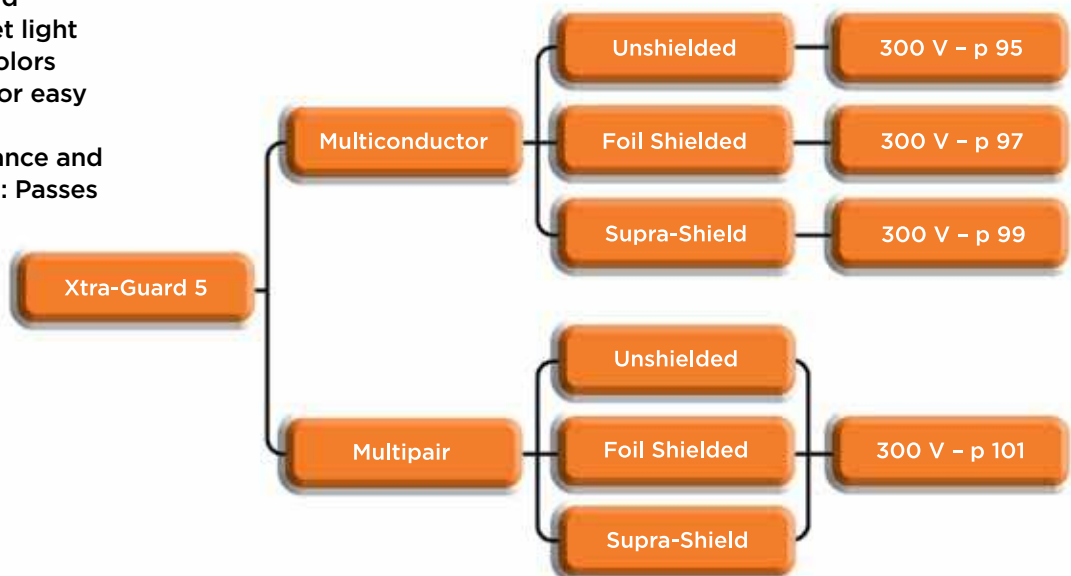

Xtra-Guard® 5



Maximum Temperature and Chemical Performance 300 V Unshielded, Multiconductor

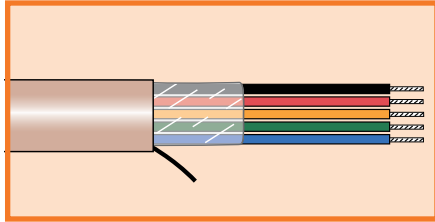

UL AWM 20229
UL CMP
CSA CMP FT6

Operating Temperature

- -80°C to +200°C
- -80°C to +150°C (AWM, CMP)

Conductor Color Coding

- Chart E (page 532)
- Nine jacket tints (tan standard)
- Custom colors available

Materials

- Stranded tinned copper conductors
- FEP insulation
- FEP jacket
- Aramid fiber ripcord

Availability

Made to order
1000 ft (305 m) minimum

FIT® Tubing Recommendations

- FIT-650: Chemical/temperature resistant flexible fluoroelastomer
- FIT-400: Temperature/chemical resistant FEP

24 AWG (0.23 mm²)

Stranding: 7/32 (7 x 0.20 mm)
Insulation thickness: 0.010 (0.25 mm)

Part No.	Conductors	Nominal Diameter		Jacket Thickness	
		Inch	mm	Inch	mm
55012	2	0.148	3.76	0.027	0.69
55013	3	0.155	3.94	0.027	0.69
55014	4	0.166	4.22	0.027	0.69
55016	6	0.193	4.90	0.027	0.69
55019	9	0.220	5.59	0.027	0.69
55020/12	12	0.243	6.17	0.027	0.69

22 AWG (0.35 mm²)

Stranding: 7/30 (7 x 0.25 mm)
Insulation thickness: 0.010 (0.25 mm)

Part No.	Conductors	Nominal Diameter		Jacket Thickness	
		Inch	mm	Inch	mm
55002	2	0.160	4.06	0.027	0.69
55003	3	0.168	4.27	0.027	0.69
55004	4	0.181	4.60	0.027	0.69
55006	6	0.211	5.36	0.027	0.69
55009	9	0.242	6.15	0.027	0.69
55010/12	12	0.268	6.81	0.027	0.69

20 AWG (0.56 mm²)

Stranding: 7/28 (7 x 0.32 mm)
Insulation thickness: 0.010 (0.25 mm)

Part No.	Conductors	Nominal Diameter		Jacket Thickness	
		Inch	mm	Inch	mm
55052	2	0.176	4.47	0.027	0.69
55053	3	0.185	4.70	0.027	0.69
55054	4	0.200	5.08	0.027	0.69
55056	6	0.235	5.97	0.027	0.69
55059	9	0.271	6.88	0.027	0.69
55060/12	12	0.301	7.65	0.027	0.69



Xtra-Guard® 5



Maximum Temperature and Chemical Performance 300 V Unshielded, Multiconductor

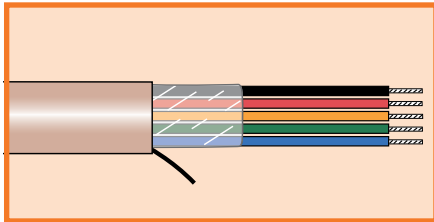

UL AWM 20229
UL CMP
CSA CMP FT6

Operating Temperature

- -80°C to +200°C
- -80°C to +150°C (AWM, CMP)

Conductor Color Coding

- Chart E (page 532)
- Nine jacket tints (tan standard)
- Custom colors available

Materials

- Stranded tinned copper conductors
- FEP insulation
- FEP jacket
- Aramid fiber ripcord

Availability

Made to order
1000 ft (305 m) minimum

FIT® Tubing Recommendations

- FIT-650: Chemical/temperature resistant flexible fluoroelastomer
- FIT-400: Temperature/chemical resistant FEP

18 AWG (0.90 mm²)

Stranding: 7/26 (7 x 0.40 mm)
Insulation thickness: 0.010 (0.25 mm)

Part No.	Conductors	Nominal Diameter		Jacket Thickness	
		Inch	mm	Inch	mm
55062	2	0.196	4.98	0.027	0.69
55063	3	0.207	5.26	0.027	0.69
55064	4	0.225	5.72	0.027	0.69
55066	6	0.265	6.73	0.027	0.69
55069	9	0.307	7.80	0.027	0.69
55070/12	12	0.343	8.71	0.027	0.69

16 AWG (1.23 mm²)

Stranding: 19/0.0117 (19 x 0.29 mm)
Insulation thickness: 0.010 (0.25 mm)

Part No.	Conductors	Nominal Diameter		Jacket Thickness	
		Inch	mm	Inch	mm
55072	2	0.218	5.54	0.027	0.69
55073	3	0.230	5.84	0.027	0.69
55074	4	0.251	6.38	0.027	0.69
55076	6	0.298	7.57	0.027	0.69
55079	9	0.347	8.81	0.027	0.69
55080/12	12	0.388	9.86	0.027	0.69



Xtra-Guard® 5



Maximum Temperature and Chemical Performance 300 V Foil Shielded, Multiconductor

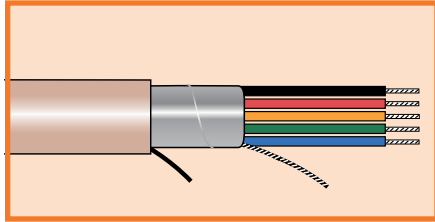

UL AWM 20229
UL CMP
CSA CMP FT6

Operating Temperature

- -80°C to +200°C
- -80°C to +150°C (AWM, CMP)

Conductor Color Coding

- Chart E (page 532)
- Nine jacket tints (tan standard)
- Custom colors available

Materials

- Stranded tinned copper conductors
- FEP insulation
- FEP jacket
- Aluminum/polyester foil shield, with 25% overlap and foil facing inward
- Tinned copper drain wire sized the same as cable conductors
- Aramid fiber ripcord

Availability

Made to order
1000 ft (305 m) minimum

FIT® Tubing Recommendations

- FIT-650: Chemical/temperature resistant flexible fluoroelastomer
- FIT-400: Temperature/chemical resistant FEP

24 AWG (0.23 mm²)

Stranding: 7/32 (7 x 0.20 mm)
Insulation thickness: 0.010 (0.25 mm)

Part No.	Conductors	Nominal Diameter		Jacket Thickness	
		Inch	mm	Inch	mm
55092	2	0.154	3.91	0.027	0.69
55093	3	0.161	4.09	0.027	0.69
55094	4	0.172	4.37	0.027	0.69
55096	6	0.199	5.05	0.027	0.69
55099	9	0.226	5.74	0.027	0.69
55100/12	12	0.249	6.32	0.027	0.69

22 AWG (0.35 mm²)

Stranding: 7/30 (7 x 0.25 mm)
Insulation thickness: 0.010 (0.25 mm)

Part No.	Conductors	Nominal Diameter		Jacket Thickness	
		Inch	mm	Inch	mm
55192	2	0.166	4.22	0.027	0.69
55193	3	0.174	4.42	0.027	0.69
55194	4	0.187	4.75	0.027	0.69
55196	6	0.217	5.51	0.027	0.69
55199	9	0.248	6.30	0.027	0.69
55199/12	12	0.274	6.96	0.027	0.69

20 AWG (0.56 mm²)

Stranding: 7/28 (7 x 0.32 mm)
Insulation thickness: 0.010 (0.25 mm)

Part No.	Conductors	Nominal Diameter		Jacket Thickness	
		Inch	mm	Inch	mm
55462	2	0.182	4.62	0.027	0.69
55463	3	0.191	4.85	0.027	0.69
55464	4	0.206	5.23	0.027	0.69
55466	6	0.241	6.12	0.027	0.69
55469	9	0.277	7.04	0.027	0.69
55470/12	12	0.307	7.80	0.027	0.69



Xtra-Guard® 5



Maximum Temperature and Chemical Performance 300 V Foil Shielded, Multiconductor

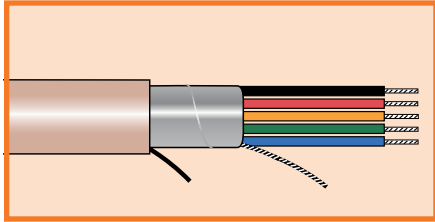

UL AWM 20229
UL CMP
CSA CMP FT6

Operating Temperature

- -80°C to +200°C
- -80°C to +150°C (AWM, CMP)

Conductor Color Coding

- Chart E (page 532)
- Nine jacket tints (tan standard)
- Custom colors available

Materials

- Stranded tinned copper conductors
- FEP insulation
- FEP jacket
- Aluminum/polyester foil shield, with 25% overlap and foil facing inward
- Tinned copper drain wire sized the same as cable conductors
- Aramid fiber ripcord

Availability

Made to order
1000 ft (305 m) minimum

FIT® Tubing Recommendations

- FIT-650: Chemical/temperature resistant flexible fluoroelastomer
- FIT-400: Temperature/chemical resistant FEP

18 AWG (0.90 mm²)

Stranding: 7/26 (7 x 0.40 mm)
Insulation thickness: 0.010 (0.25 mm)

Part No.	Conductors	Nominal Diameter		Jacket Thickness	
		Inch	mm	Inch	mm
55382	2	0.202	5.13	0.027	0.69
55383	3	0.213	5.41	0.027	0.69
55384	4	0.231	5.87	0.027	0.69
55386	6	0.271	6.88	0.027	0.69
55389	9	0.313	7.95	0.027	0.69
55390/12	12	0.349	8.86	0.027	0.69

16 AWG (1.23 mm²)

Stranding: 19/0.0117 (19 x 0.29 mm)
Insulation thickness: 0.010 (0.25 mm)

Part No.	Conductors	Nominal Diameter		Jacket Thickness	
		Inch	mm	Inch	mm
55362	2	0.224	5.69	0.027	0.69
55363	3	0.236	5.99	0.027	0.69
55364	4	0.257	6.53	0.027	0.69
55366	6	0.304	7.72	0.027	0.69
55369	9	0.353	8.97	0.027	0.69
55370/12	12	0.394	10.01	0.027	0.69



Xtra-Guard® 5



Maximum Temperature and Chemical Performance 300 V Supra-Shield® Foil/Braid, Multiconductor

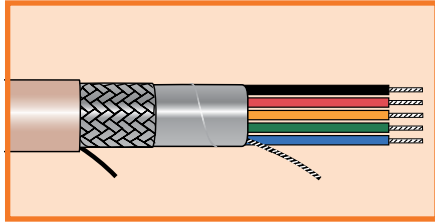

UL AWM 20229
UL CMP
CSA CMP FT6

Operating Temperature

- -80°C to +200°C
- -80°C to +150°C (AWM, CMP)

Conductor Color Coding

- Chart E (page 532)
- Nine jacket tints (tan standard)
- Custom colors available

Materials

- Stranded tinned copper conductors
- FEP insulation
- FEP jacket
- Supra-Shield foil + braid shield: Aluminum/polyester/aluminum foil with 25% overlap min. Tinned copper drain wire sized the same as conductors Tinned copper braid, 70% coverage min.
- Aramid fiber ripcord

Availability

Made to order
1000 ft (305 m) minimum

FIT® Tubing Recommendations

- FIT-650: Chemical/temperature resistant flexible fluoroelastomer
- FIT-400: Temperature/chemical resistant FEP

24 AWG (0.23 mm²)

Stranding: 7/32 (7 x 0.20 mm)
Insulation thickness: 0.010 (0.25 mm)

Part No.	Conductors	Nominal Diameter		Jacket Thickness	
		Inch	mm	Inch	mm
55112	2	0.176	4.47	0.027	0.69
55113	3	0.183	4.65	0.027	0.69
55114	4	0.194	4.93	0.027	0.69
55116	6	0.221	5.61	0.027	0.69
55119	9	0.248	6.30	0.027	0.69
55120/12	12	0.271	6.88	0.027	0.69

22 AWG (0.35 mm²)

Stranding: 7/30 (7 x 0.25 mm)
Insulation thickness: 0.010 (0.25 mm)

Part No.	Conductors	Nominal Diameter		Jacket Thickness	
		Inch	mm	Inch	mm
55102	2	0.188	4.78	0.027	0.69
55103	3	0.196	4.98	0.027	0.69
55104	4	0.209	5.31	0.027	0.69
55106	6	0.239	6.07	0.027	0.69
55109	9	0.270	6.86	0.027	0.69
55110/12	12	0.296	7.52	0.027	0.69

20 AWG (0.56 mm²)

Stranding: 7/28 (7 x 0.32 mm)
Insulation thickness: 0.010 (0.25 mm)

Part No.	Conductors	Nominal Diameter		Jacket Thickness	
		Inch	mm	Inch	mm
55152	2	0.204	5.18	0.027	0.69
55153	3	0.213	5.41	0.027	0.69
55154	4	0.228	5.79	0.027	0.69
55156	6	0.263	6.68	0.027	0.69
55159	9	0.299	7.59	0.027	0.69
55160/12	12	0.329	8.36	0.027	0.69



Xtra-Guard® 5



Maximum Temperature and Chemical Performance 300 V Supra-Shield® Foil/Braid, Multiconductor

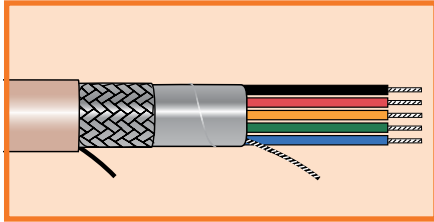

UL AWM 20229
UL CMP
CSA CMP FT6

Operating Temperature

- -80°C to +200°C
- -80°C to +150°C (AWM, CMP)

Conductor Color Coding

- Chart E (page 532)
- Nine jacket tints (tan standard)
- Custom colors available

Materials

- Stranded tinned copper conductors
- FEP insulation
- FEP jacket
- Supra-Shield foil + braid shield: Aluminum/polyester/aluminum foil with 25% overlap min.
Tinned copper drain wire sized the same as conductors
Tinned copper braid, 70% coverage min.
- Aramid fiber ripcord

Availability

Made to order
1000 ft (305 m) minimum

FIT® Tubing Recommendations

- FIT-650: Chemical/temperature resistant flexible fluoroelastomer
- FIT-400: Temperature/chemical resistant FEP

18 AWG (0.90 mm²)

Stranding: 7/26 (7 x 0.40 mm)
Insulation thickness: 0.010 (0.25 mm)

Part No.	Conductors	Nominal Diameter		Jacket Thickness	
		Inch	mm	Inch	mm
55162	2	0.224	5.69	0.027	0.69
55163	3	0.235	5.97	0.027	0.69
55164	4	0.253	6.43	0.027	0.69
55166	6	0.293	7.44	0.027	0.69
55169	9	0.335	8.51	0.027	0.69
55170/12	12	0.371	9.42	0.027	0.69

16 AWG (1.23 mm²)

Stranding: 19/0.0117 (19 x 0.29 mm)
Insulation thickness: 0.010 (0.25 mm)

Part No.	Conductors	Nominal Diameter		Jacket Thickness	
		Inch	mm	Inch	mm
55172	2	0.246	6.25	0.027	0.69
55173	3	0.258	6.55	0.027	0.69
55174	4	0.279	7.09	0.027	0.69
55176	6	0.326	8.28	0.027	0.69
55179	9	0.375	9.53	0.027	0.69
55180/12	12	0.416	10.57	0.027	0.69



Xtra-Guard® 5



Maximum Temperature and Chemical Performance 300 V Unshielded, Multipair

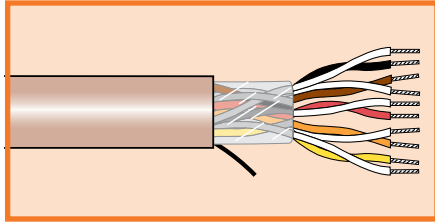

UL AWM 20229
UL CMP
CSA CMP FT6

Operating Temperature

- -80°C to +200°C
- -80°C to +150°C (AWM, CMP)

Conductor Color Coding

- Chart A (page 528)
- Nine jacket tints (tan standard)
- Custom colors available

Materials

- Stranded tinned copper conductors
- FEP insulation
- FEP jacket
- Aramid fiber ripcord

Availability

Made to order
1000 ft (305 m) minimum

FIT® Tubing Recommendations

- FIT-650: Chemical/temperature resistant flexible fluoroelastomer
- FIT-400: Temperature/chemical resistant FEP

22 AWG (0.35 mm ²)					
Stranding: 7/30 (7 x 0.25 mm) Insulation thickness: 0.010 (0.25 mm)					
Part No.	Pairs	Nominal Diameter		Jacket Thickness	
		Inch	mm	Inch	mm
55021	1	0.160	4.06	0.027	0.69
55022	2	0.224	5.69	0.027	0.69
55023	3	0.237	6.02	0.027	0.69
55026	6	0.307	7.80	0.027	0.69
55029	9	0.358	9.09	0.027	0.69
55029/12	12	0.401	10.19	0.027	0.69



Xtra-Guard® 5



Maximum Temperature and Chemical Performance 300 V Foil Shield, Multipair

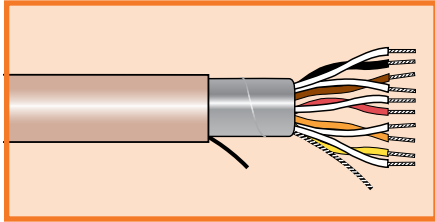

UL AWM 20229
UL CMP
CSA CMP FT6

Operating Temperature

- -80°C to +200°C
- -80°C to +150°C (AWM, CMP)

Conductor Color Coding

- Chart A (page 528)
- Nine jacket tints (tan standard)
- Custom colors available

Materials

- Stranded tinned copper conductors
- FEP insulation
- FEP jacket
- Aluminum/polyester foil shield, with 25% overlap and foil facing inward
- Tinned copper drain wire sized the same as cable conductors
- Aramid fiber ripcord

Availability

Made to order
1000 ft (305 m) minimum

FIT® Tubing Recommendations

- FIT-650: Chemical/temperature resistant flexible fluoroelastomer
- FIT-400: Temperature/chemical resistant FEP

Stranding: 7/32 (7 x 0.20 mm) Insulation thickness: 0.010 (0.25 mm)					
Part No.	Pairs	Nominal Diameter		Jacket Thickness	
		Inch	mm	Inch	mm
55491	1	0.154	3.91	0.027	0.69
55492	2	0.210	5.33	0.027	0.69
55493	3	0.222	5.64	0.027	0.69
55496	6	0.284	7.21	0.027	0.69
55499	9	0.329	8.36	0.027	0.69
55499/11	11	0.355	9.02	0.027	0.69

22 AWG (0.35 mm ²)					
Stranding: 7/30 (7 x 0.25 mm) Insulation thickness: 0.010 (0.25 mm)					
Part No.	Pairs	Nominal Diameter		Jacket Thickness	
		Inch	mm	Inch	mm
55481	1	0.166	4.22	0.027	0.69
55482	2	0.230	5.84	0.027	0.69
55483	3	0.243	6.17	0.027	0.69
55486	6	0.313	7.95	0.027	0.69
55489	9	0.364	9.25	0.027	0.69
55489/12	12	0.407	10.34	0.027	0.69

20 AWG (0.56 mm ²)					
Stranding: 7/28 (7 x 0.32 mm) Insulation thickness: 0.010 (0.25 mm)					
Part No.	Pairs	Nominal Diameter		Jacket Thickness	
		Inch	mm	Inch	mm
55451	1	0.182	4.62	0.027	0.69
55452	2	0.256	6.50	0.027	0.69
55453	3	0.271	6.88	0.027	0.69
55455	5	0.324	8.23	0.027	0.69
55456	6	0.353	8.97	0.027	0.69
55459	9	0.412	10.46	0.027	0.69
55459/12	12	0.461	11.71	0.027	0.69

18 AWG (0.90 mm ²)					
Stranding: 7/26 (7 x 0.40 mm) Insulation thickness: 0.010 (0.25 mm)					
Part No.	Pairs	Nominal Diameter		Jacket Thickness	
		Inch	mm	Inch	mm
55371	1	0.202	5.13	0.027	0.69
55372	2	0.289	7.34	0.027	0.69
55373	3	0.306	7.77	0.027	0.69
55376	6	0.402	10.21	0.027	0.69
55379	9	0.472	11.99	0.027	0.69



Xtra-Guard® 5



Maximum Temperature and Chemical Performance 300 V Supra-Shield® Foil/Braid, Multipair

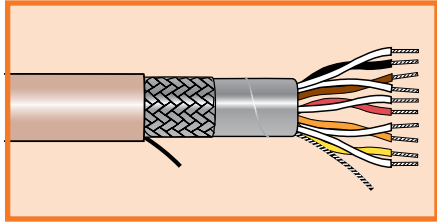

UL AWM 20229
UL CMP
CSA CMP FT6

Operating Temperature

- -80°C to +200°C
- -80°C to +150°C (AWM, CMP)

Conductor Color Coding

- Chart A (page 528)
- Nine jacket tints (tan standard)
- Custom colors available

Materials

- Stranded tinned copper conductors
- FEP insulation
- FEP jacket
- Supra-Shield foil + braid shield: Aluminum/polyester/aluminum foil with 25% overlap min. Tinned copper drain wire sized the same as conductors
- Tinned copper braid, 70% coverage min.
- Aramid fiber ripcord

Availability

Made to order
1000 ft (305 m) minimum

FIT® Tubing Recommendations

- FIT-650: Chemical/temperature resistant flexible fluoroelastomer
- FIT-400: Temperature/chemical resistant FEP

24 AWG (0.23 mm²)

Stranding: 7/32 (7 x 0.20 mm)
Insulation thickness: 0.010 (0.25 mm)

Part No.	Pairs	Nominal Diameter		Jacket Thickness	
		Inch	mm	Inch	mm
55271	1	0.176	4.47	0.027	0.69
55272	2	0.232	5.89	0.027	0.69
55273	3	0.244	6.20	0.027	0.69
55276	6	0.306	7.77	0.027	0.69
55279	9	0.351	8.92	0.027	0.69
55279/12	12	0.388	9.86	0.027	0.69

22 AWG (0.35 mm²)

Stranding: 7/30 (7 x 0.25 mm)
Insulation thickness: 0.010 (0.25 mm)

Part No.	Pairs	Nominal Diameter		Jacket Thickness	
		Inch	mm	Inch	mm
55121	1	0.188	4.78	0.027	0.69
55122	2	0.252	6.40	0.027	0.69
55123	3	0.265	6.73	0.027	0.69
55126	6	0.335	8.51	0.027	0.69
55129	9	0.386	9.80	0.027	0.69
55129/12	12	0.429	10.90	0.027	0.69

20 AWG (0.56 mm²)

Stranding: 7/28 (7 x 0.32 mm)
Insulation thickness: 0.010 (0.25 mm)

Part No.	Pairs	Nominal Diameter		Jacket Thickness	
		Inch	mm	Inch	mm
55291	1	0.204	5.18	0.027	0.69
55292	2	0.278	7.06	0.027	0.69
55293	3	0.293	7.44	0.027	0.69
55296	6	0.375	9.53	0.027	0.69
55299	9	0.434	11.02	0.027	0.69
55299/12	12	0.483	12.27	0.027	0.69

18 AWG (0.90 mm²)

Stranding: 7/26 (7 x 0.40 mm)
Insulation thickness: 0.010 (0.25 mm)

Part No.	Pairs	Nominal Diameter		Jacket Thickness	
		Inch	mm	Inch	mm
55131	1	0.224	5.69	0.027	0.69
55132	2	0.311	7.90	0.027	0.69
55133	3	0.328	8.33	0.027	0.69
55136	6	0.424	10.77	0.027	0.69
55139	9	0.504	12.80	0.032	0.81



Xtra-Guard® Flex Cables

Flexible/Flexing



Meet a wide range of flexing needs with Xtra-Guard Flex cables, from light flexing to continuous multiaxis flexing. These long-lasting flexible cables are designed to provide excellent performance in high-flex, high torsion, and continuous flex applications, such as motion control and robotics.

Application	Xtra-Guard Cable	Voltage Rating	Flex Cycles
Light to moderate flexing	Xtra-Guard Standard Flex Control	600	1 million
Continuous flex control	Xtra-Guard Continuous Flex Control	600	14 million
Continuous flex data	Xtra-Guard Continuous Flex Data	300	6 million
Torsional flex	Xtra-Guard Torsional Flex	600	1 million

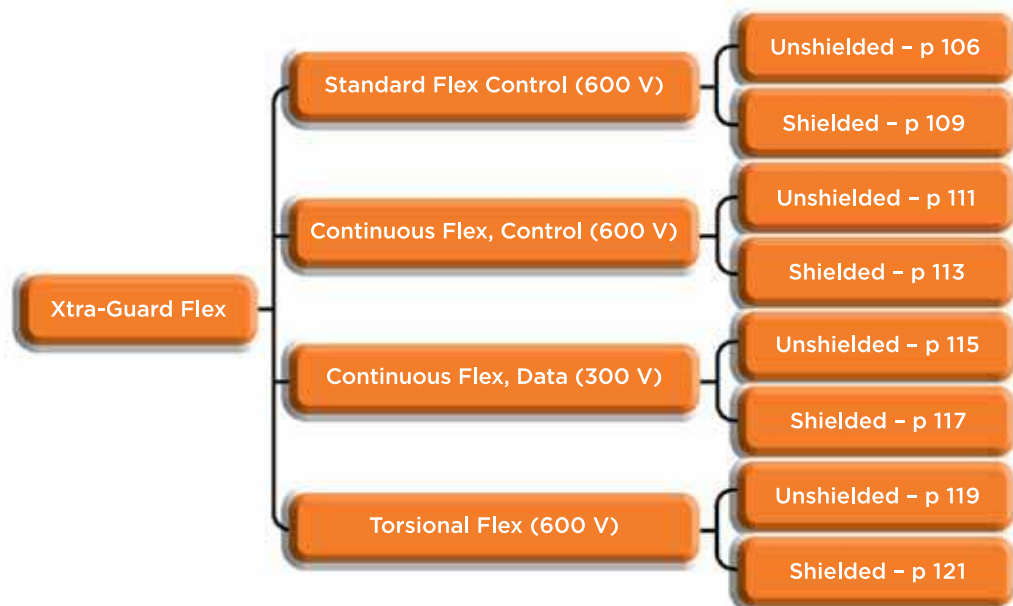

Xtra-Guard® Flex Cables

Flexible/Flexing

Xtra-Guard cables are available in a variety of configurations to allow exactly the right cable to be selected for your flexing application. There are four common types of cable flexing movements to consider when designing and applying a high-flexing cable and they are:

- **Rolling flex**, such as C-track or Cartesian motions
- **Bending flex** or “tic-toc,” such as hinged panels
- **Torsional flex**, such as twisting
- **Variable/random motion flex**

Different cable construction methods and materials are used depending on the cable flexing movement. For example: torsional cables will have a different lay length and cabling from a rolling flex cable. The performance of a cable is evaluated using physical test data and statistical analysis to produce what is known as “flex life” and overall system reliability.

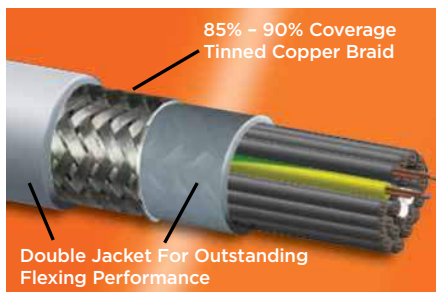

Our high-flex shielding options include a double-jacket configuration with 85% braid coverage to achieve high shielding effectiveness while maintaining the desired flexibility. For torsional flex applications, we offer spiral wound shielding with 90% coverage.



Rolling Flex

- Xtra-Guard Continuous Flex Control Cable (600 V)
- Xtra-Guard Continuous Flex Data Cable (300 V)

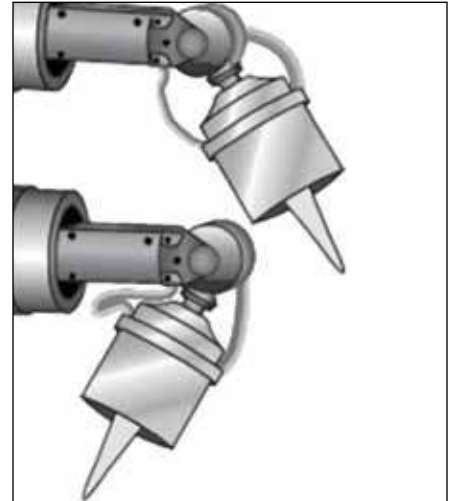

Variable/Random Flex

- Xtra-Guard Standard Flex Cable (600 V)
- Xtra-Guard Continuous Flex Control Cable (600 V)
- Xtra-Guard Continuous Flex Data Cable (300 V)

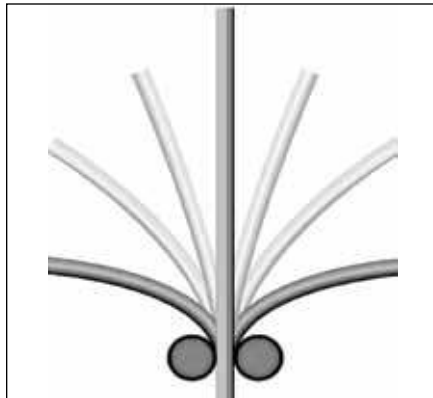

Bending Flex

- Xtra-Guard Standard Flex Cable (600 V)
- Xtra-Guard Continuous Flex Control Cable (600 V)
- Xtra-Guard Continuous Flex Data Cable (300 V)

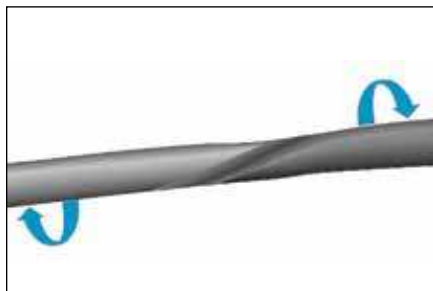

Torsion Flex

- Xtra-Guard Torsional Flex Cable (600 V)

Applications

- Cartesian robots
- Articulated multi-axis robots
- Automation networking
- Machine tools
- Automotive assembly equipment
- Conveyor systems
- Control panels
- Flex and static track
- Transfer shuttles
- Sensor/actuator-to-controller connections
- Material-handling equipment

Xtra-Guard® Standard Flex Control Cable



Light to Moderate Flex Applications
600 V Unshielded, Multiconductor

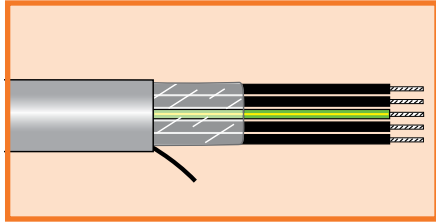

UL AWM 2587
CSA AWM I/II A/B FT1
CE

Operating Temperature

- -5°C to +90°C (flexing)
- -40°C to +90°C (stationary)

Conductor Color Coding

- Numbered black conductors
- 1 yellow/green ground conductor (3 conductor and greater)
- Jacket color: slate

Materials

- Finely stranded bare copper conductors
- Lubricated PVC insulation
- Oil-resistant PVC jacket

Availability

100 ft (30.5 m)
500 ft (152 m)
1000 ft (305 m)
Bulk, cut to length

FIT® Tubing Recommendations

- FIT-FLEX: Highly flexible, cross-linked silicone rubber
- FIT-650: Chemical/temperature resistant cross-linked fluoroelastomer

20 AWG (0.51 mm²)

Stranding: 10/30 (10 x 0.25 mm)
Insulation thickness: 0.022 (0.56 mm)

Part No.	Conductors	Nominal Diameter		Jacket Thickness	
		Inch	mm	Inch	mm
65002	2	0.238	6.05	0.035	0.89
65003	3	0.251	6.38	0.035	0.89
65004	4	0.272	6.91	0.035	0.89
65005	5	0.305	7.75	0.038	0.97
65007	7	0.327	8.31	0.038	0.97
65009	9	0.416	10.57	0.040	1.02
65012	12	0.433	11.00	0.045	1.14
65018	18	0.527	13.39	0.055	1.40
65025	25	0.615	15.62	0.055	1.40

18 AWG (0.81 mm²)

Stranding: 16/30 (16 x 0.25 mm)
Insulation thickness: 0.022 (0.56 mm)

Part No.	Conductors	Nominal Diameter		Jacket Thickness	
		Inch	mm	Inch	mm
65802	2	0.258	6.55	0.035	0.89
65803	3	0.272	6.91	0.035	0.89
65804	4	0.296	7.52	0.035	0.89
65805	5	0.326	8.28	0.035	0.89
65807	7	0.351	8.92	0.035	0.89
65809	9	0.445	11.30	0.035	0.89
65812	12	0.470	11.94	0.043	1.09
65818	18	0.567	14.40	0.050	1.27
65825	25	0.666	16.92	0.050	1.27
65834	34	0.769	19.53	0.060	1.52
65841	41	0.835	21.21	0.063	1.60
65850	50	0.967	24.56	0.083	2.11

16 AWG (1.32 mm²)

Stranding: 26/30 (26 x 0.25 mm)
Insulation thickness: 0.022 (0.56 mm)

Part No.	Conductors	Nominal Diameter		Jacket Thickness	
		Inch	mm	Inch	mm
65602	2	0.284	7.21	0.035	0.89
65603	3	0.300	7.62	0.035	0.89
65604	4	0.328	8.33	0.035	0.89
65605	5	0.361	9.17	0.035	0.89
65607	7	0.390	9.91	0.035	0.89
65609	9	0.509	12.93	0.041	1.04
65612	12	0.536	13.61	0.049	1.24
65618	18	0.632	16.05	0.050	1.27
65625	25	0.756	19.20	0.055	1.40
65641	41	0.959	24.36	0.075	1.90
65650	50	1.079	27.41	0.083	2.11



Xtra-Guard® Standard Flex Control Cable



Light to Moderate Flex Applications
600 V Unshielded, Multiconductor

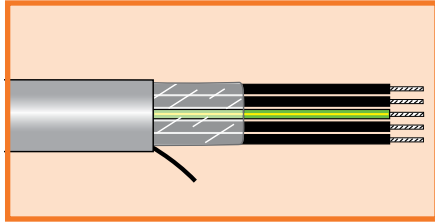

UL AWM 2587
CSA AWM I/II A/B FT1
CE

Operating Temperature

- -5°C to +90°C (flexing)
- -40°C to +90°C (stationary)

Conductor Color Coding

- Numbered black conductors
- 1 yellow/green ground conductor (3 conductor and greater)
- Jacket color: slate

Materials

- Finely stranded bare copper conductors
- Lubricated PVC insulation
- Oil-resistant PVC jacket

Availability

100 ft (30.5 m)
500 ft (152 m)
1000 ft (305 m)
Bulk, cut to length

FIT® Tubing Recommendations

- FIT-FLEX: Highly flexible, cross-linked silicone rubber
- FIT-650: Chemical/temperature resistant cross-linked fluoroelastomer

14 AWG (2.08 mm²)

Stranding: 41/30 (41 x 0.25 mm)
Insulation thickness: 0.022 (0.56 mm)

Part No.	Conductors	Nominal Diameter		Jacket Thickness	
		Inch	mm	Inch	mm
65402	2	0.330	8.38	0.044	1.12
65403	3	0.351	8.92	0.045	1.14
65404	4	0.404	10.26	0.055	1.40
65405	5	0.439	11.15	0.055	1.40
65407	7	0.479	12.17	0.058	1.47
65409	9	0.609	15.47	0.063	1.60
65412	12	0.667	16.94	0.085	2.16
65418	18	0.783	19.89	0.090	2.29
65425	25	0.953	24.21	0.110	2.79

12 AWG (3.29 mm²)

Stranding: 65/30 (65 x 0.25 mm)
Insulation thickness: 0.022 (0.56 mm)

Part No.	Conductors	Nominal Diameter		Jacket Thickness	
		Inch	mm	Inch	mm
65203	3	0.436	11.07	0.067	1.70
65204	4	0.500	12.70	0.080	2.03
65205	5	0.553	14.05	0.086	2.18
65207	7	0.592	15.04	0.086	2.18

10 AWG (5.32 mm²)

Stranding: 105/30 (105 x 0.25 mm)
Insulation thickness: 0.022 (0.56 mm)

Part No.	Conductors	Nominal Diameter		Jacket Thickness	
		Inch	mm	Inch	mm
65103	3	0.516	13.11	0.080	2.03
65104	4	0.568	14.43	0.084	2.13
65105	5	0.629	15.98	0.090	2.29

8 AWG (8.32 mm²)

Stranding: 65/26 (65 x 0.40 mm)
Insulation thickness: 0.032 (0.81 mm)

Part No.	Conductors	Nominal Diameter		Jacket Thickness	
		Inch	mm	Inch	mm
65904	4	0.691	17.55	0.085	2.16
65905	5	0.765	19.43	0.090	2.29



Xtra-Guard® Standard Flex Control Cable



Light to Moderate Flex Applications
600 V Unshielded, Multiconductor

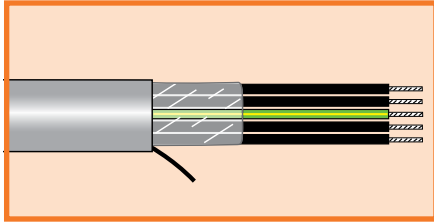

UL AWM 2587
CSA AWM I/II A/B FT1
CE

Operating Temperature

- -5°C to +90°C (flexing)
- -40°C to +90°C (stationary)

Conductor Color Coding

- Numbered black conductors
- 1 yellow/green ground conductor
- Jacket color: slate

Materials

- Finely stranded bare copper conductors
- Lubricated PVC insulation
- Oil-resistant PVC jacket

Availability

100 ft (30.5 m)
500 ft (152 m)
1000 ft (305 m)
Bulk, cut to length

FIT® Tubing Recommendations

- FIT-FLEX: Highly flexible, cross-linked silicone rubber
- FIT-650: Chemical/temperature resistant cross-linked fluoroelastomer

6 AWG (13.44 mm²)

Stranding: 105/26 (105 x 0.40 mm)
Insulation thickness: 0.047 (1.19 mm)

Part No.	Conductors	Nominal Diameter		Jacket Thickness	
		Inch	mm	Inch	mm
65704	4	0.891	22.63	0.100	2.54
65705	5	0.985	25.02	0.105	2.67

4 AWG (21.5 mm²)

Stranding: 168/26 (168 x 0.40 mm)
Insulation thickness: 0.047 (1.19 mm)

Part No.	Conductors	Nominal Diameter		Jacket Thickness	
		Inch	mm	Inch	mm
65504	4	1.080	27.43	0.100	2.54
65505	5	1.207	30.66	0.110	2.79

2 AWG (34.05 mm²)

Stranding: 266/26 (266 x 0.40 mm)
Insulation thickness: 0.047 (1.19 mm)

Part No.	Conductors	Nominal Diameter		Jacket Thickness	
		Inch	mm	Inch	mm
65304	4	1.273	32.33	0.120	3.05
65305	5	1.428	36.27	0.135	3.43



Xtra-Guard® Standard Flex Control Cable



Light to Moderate Flex Applications
600 V Shielded, Multiconductor

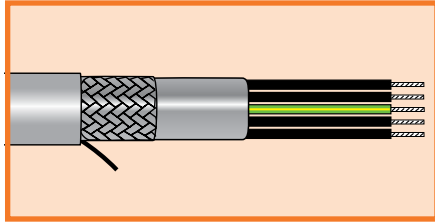

UL AWM 2587
CSA AWM I/II A/B FT1
CE

Operating Temperature

- -5°C to +90°C (flexing)
- -40°C to +90°C (stationary)

Conductor Color Coding

- Numbered black conductors
- 1 yellow/green ground conductor
- Jacket color: slate

Materials

- Finely stranded bare copper conductors
- Lubricated PVC Insulation
- Oil-resistant PVC jacket
- Tinned copper braid shield, 85% coverage

Availability

100 ft (30.5 m)
500 ft (152 m)
1000 ft (305 m)
Bulk, cut to length

FIT® Tubing Recommendations

- FIT-FLEX: Highly flexible, cross-linked silicone rubber
- FIT-650: Chemical/temperature resistant cross-linked fluoroelastomer

20 AWG (0.51 mm²)

Stranding: 10/30 (10 x 0.25 mm)
Insulation thickness: 0.022 (0.56 mm)

Part No.	Conductors	Nominal Diameter		Jacket Thickness	
		Inch	mm	Inch	mm
65003CY	3	0.339	8.61	0.035	0.89
65007CY	7	0.409	10.39	0.035	0.89
65012CY	12	0.521	13.23	0.040	1.02
65025CY	25	0.712	18.08	0.050	1.27

18 AWG (0.81 mm²)

Stranding: 16/30 (16 x 0.25 mm)
Insulation thickness: 0.022 (0.56 mm)

Part No.	Conductors	Nominal Diameter		Jacket Thickness	
		Inch	mm	Inch	mm
65803CY	3	0.360	9.14	0.035	0.89
65804CY	4	0.384	9.75	0.035	0.89
65805CY	5	0.414	10.52	0.035	0.89
65807CY	7	0.439	11.15	0.035	0.89
65812CY	12	0.568	14.43	0.045	1.14
65818CY	18	0.671	17.04	0.053	1.35
65825CY	25	0.776	19.71	0.053	1.35

16 AWG (1.32 mm²)

Stranding: 26/30 (26 x 0.25 mm)
Insulation thickness: 0.022 (0.56 mm)

Part No.	Conductors	Nominal Diameter		Jacket Thickness	
		Inch	mm	Inch	mm
65603CY	3	0.388	9.86	0.035	0.89
65604CY	4	0.416	10.57	0.035	0.89
65605CY	5	0.449	11.40	0.035	0.89
65607CY	7	0.484	12.29	0.035	0.89
65612CY	12	0.640	16.26	0.052	1.32
65618CY	18	0.767	19.48	0.062	1.57
65625CY	25	0.901	22.89	0.067	1.70

14 AWG (2.08 mm²)

Stranding: 41/30 (41 x 0.25 mm)
Insulation thickness: 0.022 (0.56 mm)

Part No.	Conductors	Nominal Diameter		Jacket Thickness	
		Inch	mm	Inch	mm
65403CY	3	0.443	11.25	0.042	1.07
65404CY	4	0.486	12.34	0.047	1.19
65405CY	5	0.537	13.64	0.052	1.32
65407CY	7	0.581	14.76	0.057	1.45
65412CY	12	0.732	18.59	0.062	1.57
65418CY	18	0.890	22.61	0.083	2.11



Xtra-Guard® Standard Flex Control Cable



Light to Moderate Flex Applications
600 V Shielded, Multiconductor

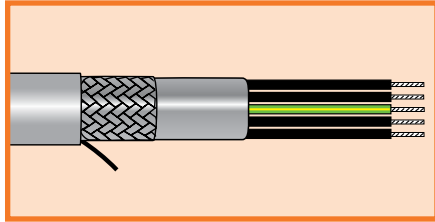

UL AWM 2587
CSA AWM I/II A/B FT1
CE

Operating Temperature

- -5°C to +90°C (flexing)
- -40°C to +90°C (stationary)

Conductor Color Coding

- Numbered black conductors
- 1 yellow/green ground conductor
- Jacket color: slate

Materials

- Finely stranded bare copper conductors
- Lubricated PVC Insulation
- PVC inner jacket
- Oil-resistant PVC jacket
- Tinned copper braid shield, 85% coverage

Availability

- 100 ft (30.5 m)
- 500 ft (152 m)
- 1000 ft (305 m)
- Bulk, cut to length

FIT® Tubing Recommendations

- FIT-FLEX: Highly flexible, cross-linked silicone rubber
- FIT-650: Chemical/temperature resistant cross-linked fluoroelastomer

12 AWG (3.31 mm²)

Stranding: 65/30 (65 x 0.25 mm)
Insulation thickness: 0.022 (0.56 mm)

Part No.	Conductors	Nominal Diameter		Jacket Thickness	
		Inch	mm	Inch	mm
65203CY	3	0.530	13.46	0.060	1.52
65204CY	4	0.616	15.65	0.066	1.68
65205CY	5	0.671	17.04	0.073	1.85

10 AWG (5.32 mm²)

Stranding: 105/30 (105 x 0.25 mm)
Insulation thickness: 0.022 (0.56 mm)

Part No.	Conductors	Nominal Diameter		Jacket Thickness	
		Inch	mm	Inch	mm
65103CY	3	0.630	16.00	0.070	1.78
65104CY	4	0.684	17.37	0.070	1.78
65105CY	5	0.757	19.23	0.077	1.96
65107CY	7	0.823	20.90	0.083	2.11

8 to 2 AWG (8.32 to 34.05 mm²)

Part No.	Conductors	Wire Size		Stranding		Nominal Diameter		Jacket Thickness		Insulation Thickness	
		AWG	mm²	AWG	mm	Inch	mm	Inch	mm	Inch	mm
65904CY	4	8	8.32	65/26	65 x 0.40	0.822	20.88	0.075	1.90	0.032	0.81
65704CY	4	6	13.44	105/26	105 x 0.40	1.062	26.97	0.100	2.54	0.047	1.19
65504CY	4	4	21.55	168/26	168 x 0.40	1.251	31.78	0.100	2.54	0.047	1.19
65304CY	4	2	34.05	266/26	266 x 0.40	1.453	36.91	0.110	2.79	0.047	1.19



Xtra-Guard® Continuous Flex Control



C-Track or High Flexing Applications Up to 14 Million Flex Life Cycles
600 V Unshielded, Multiconductor

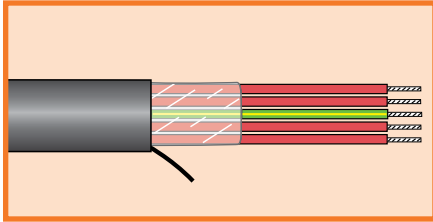

UL AWM 2587
CSA AWM I/II A/B FT1
CE

Operating Temperature

- -5°C to +90°C (flexing)
- -40°C to +90°C (stationary)

Conductor Color Coding

- Numbered red conductors
- 1 yellow/green ground conductor
- Jacket color: black

Materials

- Finely stranded tinned copper conductors
- Lubricated PVC insulation
- Oil-resistant PVC jacket

Availability

100 ft (30.5 m)
500 ft (152 m)
1000 ft (305 m)
Bulk, cut to length

FIT® Tubing Recommendations

- FIT-FLEX: Highly flexible, cross-linked silicone rubber
- FIT-650: Chemical/temperature resistant cross-linked fluoroelastomer



20 AWG (0.51 mm²)

Stranding: 63/38 (63 x 0.10 mm)
Insulation thickness: 0.022 (0.56 mm)

Part No.	Conductors	Nominal Diameter		Jacket Thickness	
		Inch	mm	Inch	mm
85003	3	0.272	6.91	0.035	0.89
85004	4	0.297	7.54	0.035	0.89
85005	5	0.323	8.20	0.035	0.89
85007	7	0.388	9.86	0.040	1.02
85012	12	0.460	11.68	0.045	1.14
85018	18	0.548	13.92	0.050	1.27
85025	25	0.691	17.55	0.065	1.65
85034	34	0.746	18.95	0.065	1.65

18 AWG (0.85 mm²)

Stranding: 105/38 (105 x 0.10 mm)
Insulation thickness: 0.022 (0.56 mm)

Part No.	Conductors	Nominal Diameter		Jacket Thickness	
		Inch	mm	Inch	mm
85803	3	0.298	7.57	0.035	0.89
85804	4	0.326	8.28	0.035	0.89
85805	5	0.355	9.02	0.035	0.89
85807	7	0.438	11.13	0.045	1.14
85812	12	0.520	13.21	0.050	1.27
85815	15	0.577	14.66	0.050	1.27
85818	18	0.608	15.44	0.050	1.27
85825	25	0.767	19.48	0.065	1.65
85834	34	0.830	21.08	0.065	1.65

16 AWG (1.36 mm²)

Stranding: 168/38 (168 x 0.10 mm)
Insulation thickness: 0.022 (0.56 mm)

Part No.	Conductors	Nominal Diameter		Jacket Thickness	
		Inch	mm	Inch	mm
85603	3	0.331	8.41	0.035	0.89
85604	4	0.362	9.19	0.035	0.89
85605	5	0.396	10.06	0.035	0.89
85607	7	0.478	12.14	0.040	1.02
85612	12	0.573	14.55	0.045	1.14
85618	18	0.674	17.12	0.045	1.14
85625	25	0.862	21.89	0.065	1.65
85634	34	0.936	23.77	0.065	1.65
85650	50	1.161	29.49	0.085	2.16

14 AWG (2.16 mm²)

Stranding: 266/38 (266 x 0.10 mm)
Insulation thickness: 0.022 (0.56 mm)

Part No.	Conductors	Nominal Diameter		Jacket Thickness	
		Inch	mm	Inch	mm
85404	4	0.424	10.77	0.050	1.27
85407	7	0.582	14.78	0.070	1.78

Xtra-Guard® Continuous Flex Control



C-Track or High Flexing Applications Up to 14 Million Flex Life Cycles
600 V Unshielded, Multiconductor

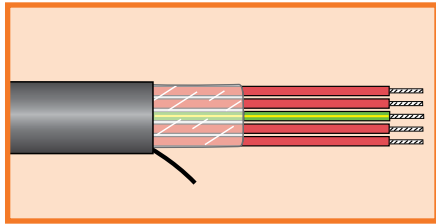

Availability

- 100 ft (30.5 m)
- 500 ft (152 m)
- 1000 ft (305 m)
- Bulk, cut to length

FIT® Tubing Recommendations

- FIT-FLEX: Highly flexible, cross-linked silicone rubber
- FIT-650: Chemical/temperature resistant cross-linked fluoroelastomer

UL AWM 2587
CSA AWM I/II A/B FT1
CE

Operating Temperature

- -5°C to +90°C (flexing)
- -40°C to +90°C (stationary)

Conductor Color Coding

- Numbered red conductors
- 1 yellow/green ground conductor
- Jacket color: black

Materials

- Finely stranded tinned copper conductors
- Lubricated PVC insulation
- Oil-resistant PVC jacket

12 AWG (3.35 mm ²)					
Stranding: 413/38 (413 x 0.10 mm)					
Insulation thickness: 0.022 (0.56 mm)					
Part No.	Conductors	Nominal Diameter		Jacket Thickness	
		Inch	mm	Inch	mm
85204	4	0.527	13.39	0.070	1.78
85207	7	0.729	18.52	0.100	2.54

10 AWG (5.34 mm ²)					
Stranding: 658/38 (658 x 0.10 mm)					
Insulation thickness: 0.022 (0.56 mm)					
Part No.	Conductors	Nominal Diameter		Jacket Thickness	
		Inch	mm	Inch	mm
85104	4	0.590	14.99	0.070	1.78
85107	7	0.816	20.73	0.100	2.54

8 to 2 AWG (8.62 to 33.86 mm ²)											
Part No.	Conductors	Wire Size		Stranding		Nominal Diameter		Jacket Thickness		Insulation Thickness	
		AWG	mm ²	AWG	mm	Inch	mm	Inch	mm	Inch	mm
85904	4	8	8.62	266/32	266 x 0.20	0.721	18.31	0.070	1.78	0.032	0.81
85704	4	6	13.38	413/32	413 x 0.20	0.935	23.75	0.085	2.16	0.047	1.19
85504	4	4	21.55	665/32	665 x 0.20	1.076	27.33	0.085	2.16	0.047	1.19
85304	4	2	33.86	1045/32	1045 x 0.20	1.250	31.75	0.085	2.16	0.047	1.19



Xtra-Guard® Continuous Flex Control



C-Track or High Flexing Applications Up to 14 Million Flex Life Cycles
600 V Shielded, Multiconductor

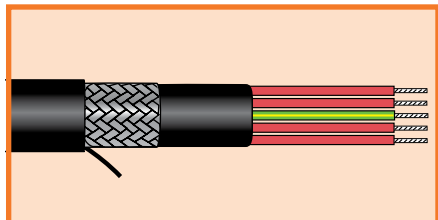

UL AWM 2587
CSA AWM I/II A/B FT1
CE

Operating Temperature

- -5°C to +90°C (flexing)
- -40°C to +90°C (stationary)

Conductor Color Coding

- Numbered red conductors
- 1 yellow/green ground conductor
- Jacket color: black

Materials

- Finely stranded bare copper conductors
- Lubricated PVC insulation
- Tinned copper braid shield, 85% coverage
- PVC inner jacket
- Oil-resistant PVC jacket

Availability

100 ft (30.5 m)
500 ft (152 m)
1000 ft (305 m)
Bulk, cut to length

FIT® Tubing Recommendations

- FIT-FLEX: Highly flexible, cross-linked silicone rubber
- FIT-650: Chemical/temperature resistant cross-linked fluoroelastomer

20 AWG (0.51 mm²)

Stranding: 63/38 (63 x 0.10 mm)
Insulation thickness: 0.022 (0.56 mm)

Part No.	Conductors	Nominal Diameter		Jacket Thickness	
		Inch	mm	Inch	mm
85003CY	3	0.350	8.89	0.035	0.89
85004CY	4	0.375	9.53	0.035	0.89
85005CY	5	0.411	10.44	0.040	1.02
85007CY	7	0.482	12.24	0.040	1.02
85010CY	10	0.545	13.84	0.040	1.02
85012CY	12	0.564	14.33	0.050	1.27
85018CY	18	0.662	16.81	0.060	1.52
85025CY	25	0.812	20.62	0.070	1.78

18 AWG (0.85 mm²)

Stranding: 105/38 (105 x 0.10 mm)
Insulation thickness: 0.022 (0.56 mm)

Part No.	Conductors	Nominal Diameter		Jacket Thickness	
		Inch	mm	Inch	mm
85803CY	3	0.376	9.55	0.035	0.89
85804CY	4	0.414	10.52	0.040	1.02
85805CY	5	0.453	11.51	0.040	1.02
85807CY	7	0.532	13.51	0.045	1.14
85812CY	12	0.634	16.10	0.060	1.52
85818CY	18	0.725	18.42	0.060	1.52
85825CY	25	0.908	23.06	0.080	2.03

16 AWG (1.36 mm²)

Stranding: 168/38 (168 x 0.10 mm)
Insulation thickness: 0.022 (0.56 mm)

Part No.	Conductors	Nominal Diameter		Jacket Thickness	
		Inch	mm	Inch	mm
85603CY	3	0.419	10.64	0.035	0.89
85604CY	4	0.460	11.68	0.040	1.02
85605CY	5	0.500	12.70	0.040	1.02
85607CY	7	0.602	15.29	0.055	1.40
85612CY	12	0.700	17.78	0.060	1.52
85615CY	15	0.769	19.53	0.060	1.52
85618CY	18	0.805	20.45	0.060	1.52
85625CY	25	0.973	24.71	0.065	1.65
85634CY	34	1.087	27.61	0.085	2.16

14 AWG (2.16 mm²)

Stranding: 266/38 (266 x 0.10 mm)
Insulation thickness: 0.022 (0.56 mm)

Part No.	Conductors	Nominal Diameter		Jacket Thickness	
		Inch	mm	Inch	mm
85404CY	4	0.528	13.41	0.050	1.27
85407CY	7	0.676	17.17	0.065	1.65



Xtra-Guard® Continuous Flex Control



C-Track or High Flexing Applications Up to 14 Million Flex Life Cycles
600 V Shielded, Multiconductor

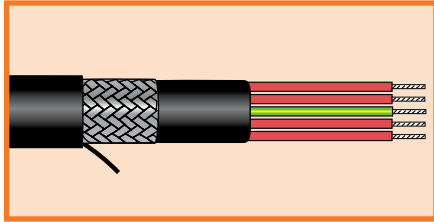

Availability

- 100 ft (30.5 m)
- 500 ft (152 m)
- 1000 ft (305 m)
- Bulk, cut to length

FIT® Tubing Recommendations

- FIT-FLEX: Highly flexible, cross-linked silicone rubber
- FIT-650: Chemical/temperature resistant cross-linked fluoroelastomer

UL AWM 2587
CSA AWM I/II A/B FT1
CE

Operating Temperature

- -5°C to +90°C (flexing)
- -40°C to +90°C (stationary)

Conductor Color Coding

- Numbered red conductors
- 1 yellow/green ground conductor
- Jacket color: black

Materials

- Finely stranded bare copper conductors
- Lubricated PVC insulation
- Tinned copper braid shield, 85% coverage
- PVC inner jacket
- Oil-resistant PVC jacket

12 AWG (3.35 mm ²)					
Stranding: 413/38 (413 x 0.10 mm)					
Insulation thickness: 0.022 (0.56 mm)					
Part No.	Conductors	Nominal Diameter		Jacket Thickness	
		Inch	mm	Inch	mm
85204CY	4	0.641	16.28	0.075	1.90
85207CY	7	0.836	21.23	0.100	2.54

10 AWG (5.34 mm ²)					
Stranding: 658/38 (658 x 0.10 mm)					
Insulation thickness: 0.022 (0.56 mm)					
Part No.	Conductors	Nominal Diameter		Jacket Thickness	
		Inch	mm	Inch	mm
85104CY	4	0.707	17.96	0.070	1.78
85107CY	7	0.947	24.05	0.100	2.54

8 to 2 AWG (8.62 to 33.86 mm ²)											
Part No.	Conductors	Wire Size		Stranding		Nominal Diameter		Jacket Thickness		Insulation Thickness	
		AWG	mm ²	AWG	mm	Inch	mm	Inch	mm	Inch	mm
85904CY	4	8	8.62	266/32	266 x 0.20	0.882	22.40	0.085	2.16	0.032	0.81
85704CY	4	6	13.38	413/32	413 x 0.20	1.066	27.08	0.085	2.16	0.047	1.19
85504CY	4	4	21.55	665/32	665 x 0.20	1.227	31.17	0.085	2.16	0.047	1.19
85304CY	4	2	33.86	1045/32	1045 x 0.20	1.431	36.35	0.095	2.41	0.047	1.19



Xtra-Guard® Continuous Flex Data



C-Track or High Flexing Applications Up to 6 Million Flex Life Cycles
300 V Unshielded, Multiconductor

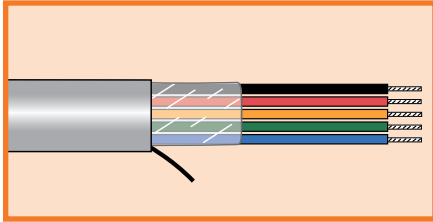

UL CM
UL AWM 2661
CSA AWM I/II A/B FT4
CSA CMG
CE

Operating Temperature

- +5°C to +105°C (flexing)
- -10°C to +105°C (stationary)

Conductor Color Coding

- Chart D (page 531)
- Jacket color: slate

Materials

- Finely stranded tinned copper conductors
- Lubricated semi-rigid PVC insulation
- Oil-resistant PVC jacket

Availability

100 ft (30.5 m)
500 ft (152 m)
1000 ft (305 m)
Bulk, cut to length

FIT® Tubing Recommendations

- FIT-FLEX: Highly flexible, cross-linked silicone rubber
- FIT-650: Chemical/temperature resistant cross-linked fluoroelastomer

28 AWG (0.09 mm²)

Stranding: 7/36 (7 x 0.13 mm)
Insulation thickness: 0.010 (0.25 mm)

Part No.	Conductors	Nominal Diameter		Jacket Thickness	
		Inch	mm	Inch	mm
86002	2	0.154	3.91	0.040	1.02
86003	3	0.160	4.06	0.040	1.02
86004	4	0.170	4.32	0.040	1.02
86005	5	0.180	4.57	0.040	1.02
86007	7	0.203	5.16	0.040	1.02
86012	12	0.263	6.68	0.040	1.02
86018	18	0.262	6.65	0.040	1.02
86025	25	0.309	7.85	0.040	1.02

26 AWG (0.14 mm²)

Stranding: 7/34 (7 x 0.16 mm)
Insulation thickness: 0.010 (0.25 mm)

Part No.	Conductors	Nominal Diameter		Jacket Thickness	
		Inch	mm	Inch	mm
86102	2	0.162	4.11	0.040	1.02
86103	3	0.168	4.27	0.040	1.02
86104	4	0.179	4.55	0.040	1.02
86105	5	0.191	4.85	0.040	1.02
86107	7	0.217	5.51	0.040	1.02
86112	12	0.283	7.19	0.040	1.02
86118	18	0.282	7.16	0.040	1.02
86125	25	0.335	8.51	0.040	1.02

24 AWG (0.20 mm²)

Stranding: 10/34 (10 x 0.16 mm)
Insulation thickness: 0.010 (0.25 mm)

Part No.	Conductors	Nominal Diameter		Jacket Thickness	
		Inch	mm	Inch	mm
86202	2	0.172	4.37	0.040	1.02
86203	3	0.179	4.55	0.040	1.02
86204	4	0.191	4.85	0.040	1.02
86205	5	0.205	5.21	0.040	1.02
86207	7	0.233	5.92	0.040	1.02
86212	12	0.307	7.80	0.040	1.02
86218	18	0.307	7.80	0.040	1.02
86225	25	0.376	9.55	0.045	1.14

22 AWG (0.38 mm²)

Stranding: 19/34 (19 x 0.16 mm)
Insulation thickness: 0.010 (0.25 mm)

Part No.	Conductors	Nominal Diameter		Jacket Thickness	
		Inch	mm	Inch	mm
86302	2	0.188	4.78	0.040	1.02
86303	3	0.197	5.00	0.040	1.02
86304	4	0.211	5.36	0.040	1.02
86305	5	0.227	5.77	0.040	1.02
86307	7	0.260	6.60	0.040	1.02
86312	12	0.347	8.81	0.040	1.02
86318	18	0.347	8.81	0.040	1.02
86325	25	0.426	10.82	0.045	1.14



Xtra-Guard® Continuous Flex Data



C-Track or High Flexing Applications Up to 6 Million Flex Life Cycles
300 V Foil/Spiral Shield, Multiconductor

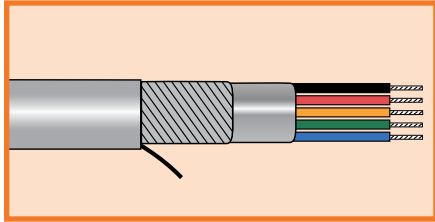

UL CM
UL AWM 2661
CSA AWM I/II A/B FT4
CSA CMG
CE

Operating Temperature

- +5°C to 105°C (flexing)
- -10°C to 105°C (stationary)

Conductor Color Coding

- Chart D (page 531)
- Jacket color: slate

Materials

- Finely stranded tinned copper conductors
- Lubricated semi-rigid PVC insulation
- Foil +spiral shield
Aluminum/polyester foil shield, 25% overlap min.
Foil facing outward
Tinned copper spiral shield, 90% coverage
- Oil-resistant PVC jacket

Availability

100 ft (30.5 m)
500 ft (152 m)
1000 ft (305 m)
Bulk, cut to length

FIT® Tubing Recommendations

- FIT-FLEX: Highly flexible, cross-linked silicone rubber
- FIT-650: Chemical/temperature resistant cross-linked fluoroelastomer



28 AWG (0.09 mm²)

Stranding: 7/36 (7 x 0.13 mm)
Insulation thickness: 0.010 (0.25 mm)

Part No.	Conductors	Nominal Diameter		Jacket Thickness	
		Inch	mm	Inch	mm
86002CY	2	0.174	4.42	0.040	1.02
86003CY	3	0.180	4.57	0.040	1.02
86004CY	4	0.190	4.83	0.040	1.02
86005CY	5	0.200	5.08	0.040	1.02
86007CY	7	0.223	5.66	0.040	1.02
86012CY	12	0.283	7.19	0.040	1.02
86018CY	18	0.282	7.16	0.040	1.02
86025CY	25	0.329	8.36	0.040	1.02

26 AWG (0.14 mm²)

Stranding: 7/34 (7 x 0.16 mm)
Insulation thickness: 0.010 (0.25 mm)

Part No.	Conductors	Nominal Diameter		Jacket Thickness	
		Inch	mm	Inch	mm
86102CY	2	0.182	4.62	0.040	1.02
86103CY	3	0.188	4.78	0.040	1.02
86104CY	4	0.199	5.05	0.040	1.02
86105CY	5	0.211	5.36	0.040	1.02
86107CY	7	0.237	6.02	0.040	1.02
86112CY	12	0.303	7.70	0.040	1.02
86118CY	18	0.302	7.67	0.040	1.02
86125CY	25	0.355	9.02	0.040	1.02

24 AWG (0.20 mm²)

Stranding: 10/34 (10 x 0.16 mm)
Insulation thickness: 0.010 (0.25 mm)

Part No.	Conductors	Nominal Diameter		Jacket Thickness	
		Inch	mm	Inch	mm
86202CY	2	0.192	4.88	0.040	1.02
86203CY	3	0.199	5.05	0.040	1.02
86204CY	4	0.211	5.36	0.040	1.02
86205CY	5	0.225	5.72	0.040	1.02
86207CY	7	0.253	6.43	0.040	1.02
86212CY	12	0.327	8.31	0.040	1.02
86218CY	18	0.327	8.31	0.040	1.02
86225CY	25	0.396	10.06	0.045	1.14

22 AWG (0.38 mm²)

Stranding: 19/34 (19 x 0.16 mm)
Insulation thickness: 0.010 (0.25 mm)

Part No.	Conductors	Nominal Diameter		Jacket Thickness	
		Inch	mm	Inch	mm
86302CY	2	0.208	5.28	0.040	1.02
86303CY	3	0.217	5.51	0.040	1.02
86304CY	4	0.231	5.87	0.040	1.02
86305CY	5	0.247	6.27	0.040	1.02
86307CY	7	0.280	7.11	0.040	1.02
86312CY	12	0.367	9.32	0.040	1.02
86318CY	18	0.367	9.32	0.040	1.02
86325CY	25	0.446	11.33	0.045	1.14

Xtra-Guard® Continuous Flex Data



C-Track or High Flexing Applications Up to 6 Million Flex Life Cycles
300 V Foil/Braid Shield, Multipair

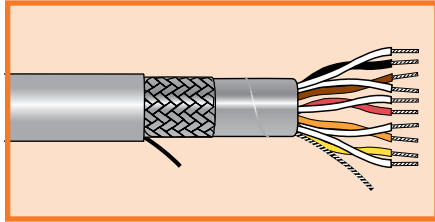

UL CM
UL AWM 2661
CSA AWM I/II A/B FT4
CSA CMG
CE

Operating Temperature

- +5°C to +105°C (flexing)
- -10°C to +105°C (stationary)

Conductor Color Coding

- Chart A (page 528)
- Jacket color: slate

Materials

- Finely stranded tinned copper conductors
- Lubricated semi-rigid PVC insulation
- Shield: Combination foil and braid
Aluminum/polyester foil shield, with 25% overlap and tinned copper drain wire
Tinned copper braid with 85% coverage
- Oil-resistant PVC jacket

Availability

100 ft (30.5 m)
500 ft (152 m)
1000 ft (305 m)
Bulk, cut to length

FIT® Tubing Recommendations

- FIT-FLEX: Highly flexible, cross-linked silicone rubber
- FIT-650: Chemical/temperature resistant cross-linked fluoroelastomer

28 AWG (0.09 mm²)

Stranding: 7/36 (7 x 0.13 mm)
Insulation thickness: 0.010 (0.25 mm)

Part No.	Pairs	Nominal Diameter		Jacket Thickness	
		Inch	mm	Inch	mm
86401CY	1	0.186	4.72	0.040	1.02
86402CY	2	0.231	5.87	0.040	1.02
86403CY	3	0.240	6.10	0.040	1.02
86404CY	4	0.256	6.50	0.040	1.02
86405CY	5	0.274	6.96	0.040	1.02
86406CY	6	0.293	7.44	0.040	1.02
86408CY	8	0.331	8.41	0.040	1.02
86410CY	10	0.365	9.27	0.045	1.14
86414CY	14	0.381	9.68	0.045	1.14

26 AWG (0.14 mm²)

Stranding: 7/34 (7 x 0.16 mm)
Insulation thickness: 0.010 (0.25 mm)

Part No.	Pairs	Nominal Diameter		Jacket Thickness	
		Inch	mm	Inch	mm
86501CY	1	0.194	4.93	0.040	1.02
86502CY	2	0.244	6.20	0.040	1.02
86503CY	3	0.254	6.45	0.040	1.02
86504CY	4	0.272	6.91	0.040	1.02
86505CY	5	0.292	7.42	0.040	1.02
86506CY	6	0.313	7.95	0.040	1.02
86508CY	8	0.355	9.02	0.040	1.02
86510CY	10	0.392	9.96	0.045	1.14
86514CY	14	0.426	10.82	0.053	1.35



Xtra-Guard® Continuous Flex Data



C-Track or High Flexing Applications Up to 6 Million Flex Life Cycles
300 V Foil/Braid Shield, Multipair

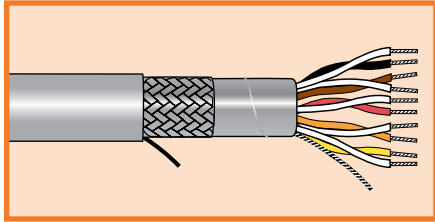

UL CM
UL AWM 2661
CSA AWM I/II A/B FT4
CSA CMG
CE

Operating Temperature

- +5°C to +105°C (flexing)
- -10°C to +105°C (stationary)

Conductor Color Coding

- Chart A (page 528)
- Jacket color: slate

Materials

- Finely stranded tinned copper conductors
- Lubricated semi-rigid PVC insulation
- Shield: Combination foil and braid
Aluminum/polyester foil shield, with 25% overlap and tinned copper drain wire
Tinned copper braid with 85% coverage
- Oil-resistant PVC jacket

Availability

100 ft (30.5 m)
500 ft (152 m)
1000 ft (305 m)
Bulk, cut to length

FIT® Tubing Recommendations

- FIT-FLEX: Highly flexible, cross-linked silicone rubber
- FIT-650: Chemical/temperature resistant cross-linked fluoroelastomer

24 AWG (0.20 mm²)

Stranding: 10/34 (10 x 0.16 mm)
Insulation thickness: 0.010 (0.25 mm)

Part No.	Pairs	Nominal Diameter		Jacket Thickness	
		Inch	mm	Inch	mm
86601CY	1	0.204	5.18	0.040	1.02
86602CY	2	0.260	6.60	0.040	1.02
86603CY	3	0.272	6.91	0.040	1.02
86604CY	4	0.292	7.42	0.040	1.02
86605CY	5	0.314	7.98	0.040	1.02
86606CY	6	0.337	8.56	0.040	1.02
86608CY	8	0.385	9.78	0.040	1.02
86610CY	10	0.427	10.85	0.045	1.14
86614CY	14	0.463	11.76	0.053	1.35

22 AWG (0.38 mm²)

Stranding: 19/34 (19 x 0.16 mm)
Insulation thickness: 0.010 (0.25 mm)

Part No.	Pairs	Nominal Diameter		Jacket Thickness	
		Inch	mm	Inch	mm
86701CY	1	0.220	5.59	0.040	1.02
86702CY	2	0.287	7.29	0.040	1.02
86703CY	3	0.301	7.65	0.040	1.02
86704CY	4	0.324	8.23	0.040	1.02
86705CY	5	0.350	8.89	0.040	1.02
86706CY	6	0.377	9.58	0.040	1.02
86708CY	8	0.443	11.25	0.045	1.14
86710CY	10	0.497	12.62	0.053	1.35
86714CY	14	0.527	13.39	0.053	1.35





Xtra-Guard® Torsional Flex

Torsional Cable with 360° Twisting
600 V Unshielded, Multiconductor

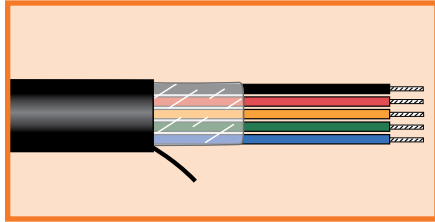

UL AWM 20234
CSA AWM I/II A/B FT1
CE

Operating Temperature

- -10°C to +80°C (flexing)
- -30°C to +80°C (stationary)

Conductor Color Coding

- Numbered black conductors
- 1 yellow/green ground conductor
- Jacket color: black

Materials

- Stranded bare copper conductors
- Thermoplastic elastomer insulation
- Oil-resistant polyurethane jacket

Availability

Bulk, cut to length

FIT® Tubing Recommendations

- FIT-FLEX: Highly flexible, cross-linked silicone rubber
- FIT-650: Chemical/temperature resistant cross-linked fluoroelastomer

24 AWG (0.23 mm²)

Stranding: 7/32 (7 x 0.20 mm)
Insulation thickness: 0.016 (0.41 mm)

Part No.	Conductors	Nominal Diameter		Jacket Thickness	
		Inch	mm	Inch	mm
87003	3	0.227	5.77	0.050	1.27
87004	4	0.242	6.15	0.050	1.27
87005	5	0.259	6.58	0.050	1.27
87007	7	0.294	7.47	0.050	1.27

22 AWG (0.38 mm²)

Stranding: 19/34 (19 x 0.16 mm)
Insulation thickness: 0.016 (0.41 mm)

Part No.	Conductors	Nominal Diameter		Jacket Thickness	
		Inch	mm	Inch	mm
87103	3	0.244	6.20	0.050	1.27
87104	4	0.261	6.63	0.050	1.27
87105	5	0.281	7.14	0.050	1.27
87107	7	0.321	8.15	0.050	1.27

20 AWG (0.62 mm²)

Stranding: 19/32 (19 x 0.20 mm)
Insulation thickness: 0.016 (0.41 mm)

Part No.	Conductors	Nominal Diameter		Jacket Thickness	
		Inch	mm	Inch	mm
87203	3	0.262	6.65	0.050	1.27
87204	4	0.281	7.14	0.050	1.27
87205	5	0.302	7.67	0.050	1.27
87207	7	0.347	8.81	0.050	1.27

18 AWG (0.96 mm²)

Stranding: 19/30 (19 x 0.25 mm)
Insulation thickness: 0.016 (0.41 mm)

Part No.	Conductors	Nominal Diameter		Jacket Thickness	
		Inch	mm	Inch	mm
87303	3	0.283	7.19	0.050	1.27
87304	4	0.305	7.75	0.050	1.27
87305	5	0.329	8.36	0.050	1.27
87307	7	0.380	9.65	0.050	1.27



Xtra-Guard® Torsional Flex



Torsional Cable with 360° Twisting
600 V Unshielded, Multiconductor

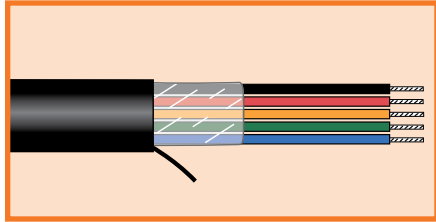

UL AWM 20234
CSA AWM I/II A/B FT1
CE

Operating Temperature

- -10°C to +80°C (flexing)
- -30°C to +80°C (stationary)

Conductor Color Coding

- Numbered black conductors
- 1 yellow/green ground conductor
- Jacket color: black

Materials

- Stranded bare copper conductors
- Thermoplastic elastomer insulation
- Oil-resistant polyurethane jacket

Availability

Bulk, cut to length

FIT® Tubing Recommendations

- FIT-FLEX: Highly flexible, cross-linked silicone rubber
- FIT-650: Chemical/temperature resistant cross-linked fluoroelastomer

16 AWG (1.32 mm²)

Stranding: 19/0.0117 (19 x 0.30 mm)
Insulation thickness: 0.016 (0.41 mm)

Part No.	Conductors	Nominal Diameter		Jacket Thickness	
		Inch	mm	Inch	mm
87403	3	0.302	7.67	0.050	1.27
87404	4	0.327	8.31	0.050	1.27
87405	5	0.354	8.99	0.050	1.27
87407	7	0.410	10.41	0.050	1.27

14 AWG (2.07 mm²)

Stranding: 19/0.0147 (19 x 0.37 mm)
Insulation thickness: 0.027 (0.69 mm)

Part No.	Conductors	Nominal Diameter		Jacket Thickness	
		Inch	mm	Inch	mm
87503	3	0.382	9.70	0.050	1.27
87504	4	0.417	10.59	0.050	1.27
87505	5	0.455	11.56	0.050	1.27
87507	7	0.535	13.59	0.050	1.27

12 AWG (3.29 mm²)

Stranding: 19/0.0185 (19 x 0.47 mm)
Insulation thickness: 0.027 (0.69 mm)

Part No.	Conductors	Nominal Diameter		Jacket Thickness	
		Inch	mm	Inch	mm
87603	3	0.444	11.28	0.060	1.52
87604	4	0.483	12.27	0.060	1.52
87605	5	0.526	13.36	0.060	1.52
87607	7	0.618	15.70	0.060	1.52

10 AWG (5.22 mm²)

Stranding: 37/0.0167 (37 x 0.42 mm)
Insulation thickness: 0.030 (0.76 mm)

Part No.	Conductors	Nominal Diameter		Jacket Thickness	
		Inch	mm	Inch	mm
87703	3	0.508	12.90	0.060	1.52
87704	4	0.555	14.10	0.060	1.52
87705	5	0.627	15.93	0.070	1.78
87707	7	0.737	18.72	0.070	1.78





Xtra-Guard® Torsional Flex

Torsional Cable with 360° Twisting
600 V Shielded, Multiconductor

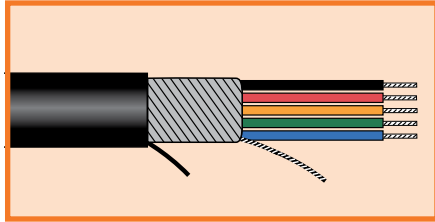

UL AWM 20234
CSA AWM I/II A/B FT1
CE

Operating Temperature

- -10°C to +80°C (flexing)
- -30°C to +80°C (stationary)

Conductor Color Coding

- Numbered black conductors
- 1 yellow/green ground conductor
- Jacket color: black

Materials

- Stranded bare copper conductors
- Thermoplastic elastomer insulation
- Tinned copper spiral shield, 90% coverage
- Oil-resistant polyurethane jacket

Availability

Bulk, cut to length

FIT® Tubing Recommendations

- FIT-FLEX: Highly flexible, cross-linked silicone rubber
- FIT-650: Chemical/temperature resistant cross-linked fluoroelastomer

24 AWG (0.23 mm²)

Stranding: 7/32 (7 x 0.20 mm)
Insulation thickness: 0.016 (0.41 mm)

Part No.	Conductors	Nominal Diameter		Jacket Thickness	
		Inch	mm	Inch	mm
87003CY	3	0.246	6.25	0.050	1.27
87004CY	4	0.261	6.63	0.050	1.27
87005CY	5	0.278	7.06	0.050	1.27
87007CY	7	0.313	7.95	0.050	1.27

22 AWG (0.38 mm²)

Stranding: 19/34 (19 x 0.16 mm)
Insulation thickness: 0.016 (0.41 mm)

Part No.	Conductors	Nominal Diameter		Jacket Thickness	
		Inch	mm	Inch	mm
87103CY	3	0.263	6.68	0.050	1.27
87104CY	4	0.280	7.11	0.050	1.27
87105CY	5	0.300	7.62	0.050	1.27
87107CY	7	0.340	8.64	0.050	1.27

20 AWG (0.62 mm²)

Stranding: 19/32 (19 x 0.20 mm)
Insulation thickness: 0.016 (0.41 mm)

Part No.	Conductors	Nominal Diameter		Jacket Thickness	
		Inch	mm	Inch	mm
87203CY	3	0.281	7.14	0.050	1.27
87204CY	4	0.300	7.62	0.050	1.27
87205CY	5	0.321	8.15	0.050	1.27
87207CY	7	0.366	9.30	0.050	1.27

18 AWG (0.96 mm²)

Stranding: 19/30 (19 x 0.25 mm)
Insulation thickness: 0.016 (0.41 mm)

Part No.	Conductors	Nominal Diameter		Jacket Thickness	
		Inch	mm	Inch	mm
87303CY	3	0.302	7.67	0.050	1.27
87304CY	4	0.324	8.23	0.050	1.27
87305CY	5	0.348	8.84	0.050	1.27
87307CY	7	0.399	10.13	0.050	1.27



Xtra-Guard® Torsional Flex



Torsional Cable with 360° Twisting
600 V Shielded, Multiconductor

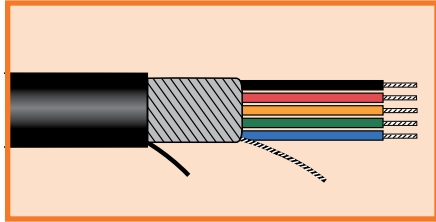

UL AWM 20234
CSA AWM I/II A/B FT1
CE

Operating Temperature

- -10°C to +80°C (flexing)
- -30°C to +80°C (stationary)

Conductor Color Coding

- Numbered black conductors
- 1 yellow/green ground conductor
- Jacket color: black

Materials

- Stranded bare copper conductors
- Thermoplastic elastomer insulation
- Tinned copper spiral shield, 90% coverage
- Oil-resistant polyurethane jacket

Availability

Bulk, cut to length

FIT® Tubing Recommendations

- FIT-FLEX: Highly flexible, cross-linked silicone rubber
- FIT-650: Chemical/temperature resistant cross-linked fluoroelastomer

16 AWG (1.32 mm²)

Stranding: 19/0.0117 (19 x 0.30 mm)
Insulation thickness: 0.016 (0.41 mm)

Part No.	Conductors	Nominal Diameter		Jacket Thickness	
		Inch	mm	Inch	mm
87403CY	3	0.321	8.15	0.050	1.27
87404CY	4	0.346	8.79	0.050	1.27
87405CY	5	0.373	9.47	0.050	1.27
87407CY	7	0.429	10.90	0.050	1.27

14 AWG (2.07 mm²)

Stranding: 19/0.0147 (19 x 0.37 mm)
Insulation thickness: 0.027 (0.69 mm)

Part No.	Conductors	Nominal Diameter		Jacket Thickness	
		Inch	mm	Inch	mm
87503CY	3	0.401	10.19	0.050	1.27
87504CY	4	0.436	11.07	0.050	1.27
87505CY	5	0.474	12.04	0.050	1.27
87507CY	7	0.554	14.07	0.050	1.27

12 AWG (3.29 mm²)

Stranding: 19/0.0185 (19 x 0.47 mm)
Insulation thickness: 0.027 (0.69 mm)

Part No.	Conductors	Nominal Diameter		Jacket Thickness	
		Inch	mm	Inch	mm
87603CY	3	0.463	11.76	0.060	1.52
87604CY	4	0.502	12.75	0.060	1.52
87605CY	5	0.545	13.84	0.060	1.52
87607CY	7	0.637	16.18	0.060	1.52

10 AWG (5.22 mm²)

Stranding: 37/0.0167 (37 x 0.42 mm)
Insulation thickness: 0.030 (0.76 mm)

Part No.	Conductors	Nominal Diameter		Jacket Thickness	
		Inch	mm	Inch	mm
87703CY	3	0.527	13.39	0.060	1.52
87704CY	4	0.574	14.58	0.060	1.52
87705CY	5	0.646	16.41	0.070	1.78
87707CY	7	0.756	19.20	0.070	1.78



Alpha Wire Industrial Series



Alpha Wire Industrial Series

Advanced cable products for industrial applications



From the factory floor to process control, the Alpha Wire Industrial Series (AWIS) cable line is well suited to the widest range of industrial applications. We offer a variety of cables for general needs such as control wiring in both stationary and moving components. We also offer application-specific configurations for use with drives, servo systems, and factory protocols.

AWIS cables are crafted for rugged, reliable performance in your industrial equipment. They are designed to handle even your toughest applications, whether your need is continuous flexing, superior oil and chemical resistance, or excellent mechanical and electrical performance.

Choose the AWIS cable with the properties you need:

- **TC-ER, PLTC, MTW, and WTTC ratings**
- **Oil and chemical resistance**
- **UV resistance**
- **Direct burial**
- **Abrasion resistance**
- **EMI protection**
- **High flex cycling**

AWIS cables give reliable performance

Series F Continuous Flex Control Cables

Rated for up to 20 million rolling flex cycles

Series M Control Cable

Excellent mechanical and electrical performance for stationary cable trays

Series P Enhanced Stationary Control Cable

Superior oil and chemical resistance plus easier routing and installation

Series SF Servo Control Cable

Maximum flexibility in servo control and power

Series V VFD Cables

Double-shielded for superior EMI performance

Series XM Flexible Control Cable

Tough PVC Cable for continuous flex control applications

Applications

- **Medium-to high-flex equipment**
- **Factory equipment interconnects**
- **Robotics**
- **Machine tools**
- **Automotive assembly equipment**
- **Conveyor systems**
- **Control panels**
- **Transfer shuttles**
- **Solar farms**
- **Automated pick-and-place systems**
- **PLC controlled equipment**
- **Automated handling systems**
- **Control/monitoring of speed and position**

Reliable productivity from the factory floor to process controls

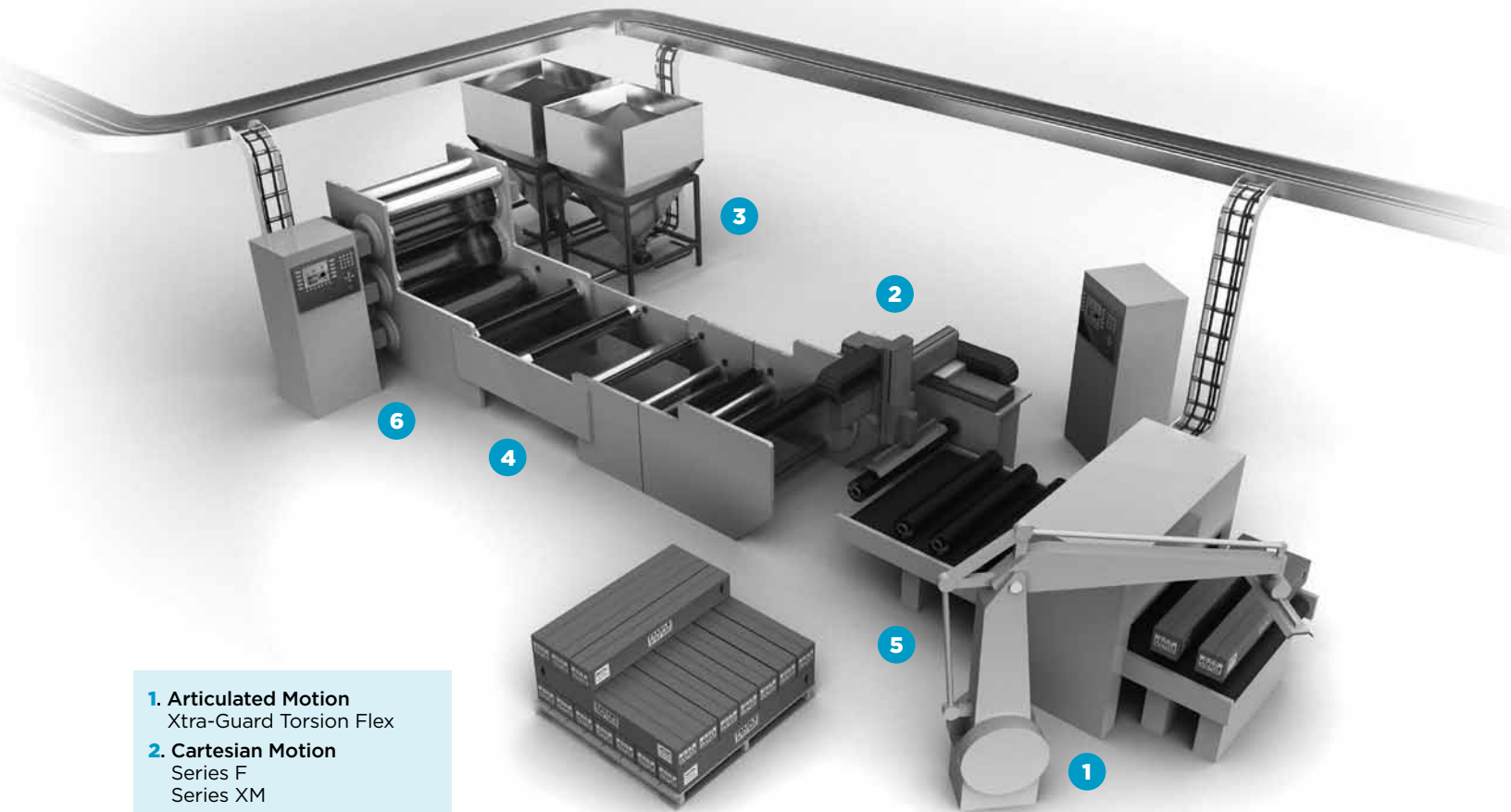

- 1. Articulated Motion**
Xtra-Guard Torsion Flex
- 2. Cartesian Motion**
Series F
Series XM
- 3. Motor**
Flexible Motor Supply
- 4. Static Control Cabling**
Series M
Series P
- 5. Servomotors**
Series SF
- 6. VFD**
Series V

Alpha Wire's industrial cables are well suited to the widest range of industrial applications from the factory floor to process controls to wind turbines. We offer a range of cables for general needs such as control wiring in both stationary and moving components. We also offer application-specific configurations for use with motors, drives, and servo systems.

General Application	Cable	Advantages
Stationary	Series M	PVC jacket Oil resistant (Oil Res. I)
Stationary/ Minimal Flex	Series P	TPE jacket Improved oil and chemical resistance (Oil Res. I/II)
Moderate Flexing	Xtra-Guard Standard Flex (65000 Series)	1 million flex cycles PVC jacket
	Series XM	12 million flex cycles Oil resistant (Oil Res. I)
	Series F	20 million flex cycles Improved oil and chemical resistance (Oil Res. I/II)
	Xtra-Guard Continuous Flex Data (86000 Series)	6 million flex cycles PVC jacket
	Xtra-Guard Continuous Flex Control (85000 Series)	14 million flex cycles PVC jacket
High Flexing	Xtra-Guard Torsional Flex (87000 Series)	1 million flex cycles TPE insulation, polyurethane jacket
	Servomotors/ Drives	Series SF TPE jacket Enhanced flexibility for easy installation and routing Improved oil and chemical resistance (Oil Res. I/II) With or without brake/ground pairs
VFD Systems	Series V	Oil resistant (Oil Res. I) Low capacitance for extended runs XLPE insulation for improved dielectric properties Excellent corona resistance Uniform geometry for reduced common-mode current
Motor Supply	Flexible Motor Supply	PVC jacket Oil resistant (Oil Res. I) Suited to light-duty flexing and VFD applications

Superior Cable by Design

Alpha industrial cables are designed to perform better, providing consistent, reliable operation. The result is more uptime, fewer errors, and precise operation of equipment. Our cables are designed and built to uncompromising standards so you get consistency and uniformity in every cable.

Superior Service by Design

Beyond our well-earned reputation for high-quality, premium-grade products, our commitment to service aims to make specifying and getting the cable you need both fast and easy.

- Global availability
- Large in-stock inventory
- Flexible ordering, with small and large put-ups available
- Fast shipping—usually the same day
- 1500 distributor locations worldwide
- Engineering support
- Extensive on-line tools to select and specify cable
- Custom designs with on-line Cable Design Center™
- Fast turnarounds on custom designs



Specific Application	Connection	Alpha Cable
Stationary	Control panel to machine	Series M, Series P
	Source power	Series M, Series P
Cartesian Robots	Flex track	Series XM, Series F, XG Flex 85000, Series SF
	Tool mechanism	XG Flex 8700 OSeries
Transfer Shuttles	Source power	Series M, Series P
	Flex track	Series XM, Series F, XG Flex 85000, Series SF
	Robot	XG Flex 87000 Series for end of arm tool
	Servomotor	Series SF
Gantry	Source power	Series M, Series P
	Track	Series XM, Series F, XG Flex 85000, Series SF
	Robot	XG Flex 87000 Series for end of arm tool
Pick and Place	Servomotor	Series SF
	Source power	XG Flex 87000 Series for end of arm tool
	Flex track	Series XM, Series F, XG Flex 85000 Series
Machine Tools	End of arm tool	XG Flex 87000 Series
	Source power	Series M, Series P
	Internal XYZ axis	Series XM, Series F, XG Flex 85000, SF Series
	Automated tool changer	Series XM, Series F, XG Flex 85000/86000 Series
	Servomotor	Series SF
Conveying Systems	Drive systems	Series V VFD
	Source power	Series M, Series P, XG Flex 65000
	Drive systems	Series V VFD
	Servomotor	Series SF
Packaging/ Material Handling	Motor supply	Flexible Motor Supply
	Source power	Series M, Series P
	Drives	Series V VFD
	Servomotor	Series SF
	Motor power/control	Motor Supply, Series M, Series P

Series F Continuous Flex Control Cables

High-Flex Cable Track Applications
600 V Unshielded, Multiconductor

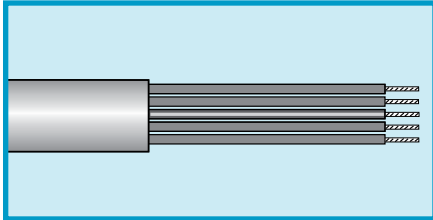

UL TC-ER, PLTC
UL TFFN (18 - 16 AWG)
UL THHN (14 - 8 AWG)
CSA AWM I/II A/B FT4
CE LVD 73/23/EEC Amend.
93/68/EEC

Operating Temperature

- 25°C to +90°C (static)
- 5°C to +90°C (dynamic)

Conductor Color Coding

- Red, blue, or black insulation*, numbered
- 1 green/yellow green conductor
- 1 white-striped neutral
- (12 conductors or greater)

Materials

- Stranded bare copper conductors
- PVC/nylon insulation
- Black oil-resistant thermoplastic elastomer jacket

Features

- UL Sunlight Resistant
- UL Oil Res. I/II
- 10x bend radius
- Over 20 million rolling flex cycles
- Tic-tock and twist test per MIL-C-13777G
- Suitable for use in Class I, Division 2 locations per Article 501 of the National Electric Code

Availability

Bulk, cut to length

FIT® Tubing Recommendations

- FIT-600: Highly flexible, cross-linked elastomer
- FIT-650: Chemical- and temperature-resistant fluoroelastomer

*Red insulation: AC circuits operating at less than line voltage
Blue insulation: DC circuits operating at less than line voltage
Black insulation: AC circuits operating at less than line voltage

18 AWG (0.83 mm ²)							
Stranding: 41/34 (41 x 0.16 mm)							
Insulation thickness: 0.016 (0.41 mm) PVC/0.005 (0.10 mm) nylon							
Part No.			Conductors	Nominal Diameter		Jacket Thickness	
Black Insul.	Blue Insul.	Red Insul.		Inch	mm	Inch	mm
F18003KW	F18003LW	F18003RW	3	0.308	7.82	0.050	1.27
F18004KW	F18004LW	F18004RW	4	0.333	8.46	0.050	1.27
F18005KW	F18005LW	F18005RW	5	0.360	9.14	0.050	1.27
F18007KW	F18007LW	F18007RW	7	0.418	10.62	0.050	1.27
F18012KW	F18012LW	F18012RW	12	0.515	13.08	0.065	1.65
F18017KW	F18017LW	F18017RW	17	0.597	15.16	0.065	1.65
F18022KW	F18022LW	F18022RW	22	0.656	16.66	0.065	1.65
F18025KW	F18025LW	F18025RW	25	0.717	18.21	0.065	1.65
F18034KW	F18034LW	F18034RW	34	0.775	19.69	0.065	1.65
F18042KW	F18042LW	F18042RW	42	0.874	22.20	0.085	2.16
F18049KW	F18049LW	F18049RW	49	0.965	24.51	0.085	2.16
F18065KW	F18065LW	F18065RW	65	1.052	26.72	0.085	2.16

16 AWG (1.31 mm ²)							
Stranding: 65/34 (65 x 0.16 mm)							
Insulation thickness: 0.016 (0.41 mm) PVC/0.005 (0.10 mm) nylon							
Part No.			Conductors	Nominal Diameter		Jacket Thickness	
Black Insul.	Blue Insul.	Red Insul.		Inch	mm	Inch	mm
F16003KW	F16003LW	F16003RW	3	0.334	8.48	0.050	1.27
F16004KW	F16004LW	F16004RW	4	0.362	9.19	0.050	1.27
F16005KW	F16005LW	F16005RW	5	0.393	9.98	0.050	1.27
F16007KW	F16007LW	F16007RW	7	0.489	12.42	0.065	1.65
F16012KW	F16012LW	F16012RW	12	0.565	14.35	0.065	1.65
F16017KW	F16017LW	F16017RW	17	0.657	16.69	0.065	1.65
F16019KW	F16019LW	F16019RW	19	0.691	17.55	0.065	1.65
F16022KW	F16022LW	F16022RW	22	0.724	18.39	0.065	1.65
F16025KW	F16025LW	F16025RW	25	0.793	20.14	0.065	1.65
F16033KW	F16033LW	F16033RW	33	0.899	22.83	0.085	2.16
F16042KW	F16042LW	F16042RW	42	0.966	24.54	0.085	2.16
F16049KW	F16049LW	F16049RW	49	1.069	27.15	0.085	2.16
F16065KW	F16065LW	F16065RW	65	1.168	29.67	0.085	2.16



Series F Continuous Flex Control Cables

High-Flex Cable Track Applications
600 V Unshielded, Multiconductor

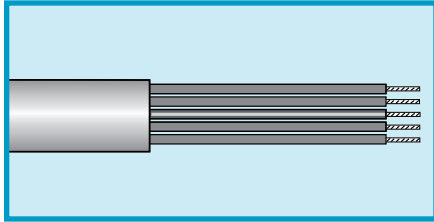

UL TC-ER, PLTC
UL TFFN (18 - 16 AWG)
UL THHN (14 - 8 AWG)
CSA AWM I/II A/B FT4
CE LVD 73/23/EEC Amend.
93/68/EEC

Operating Temperature

- 25°C to +90°C (static)
- 5°C to +90°C (dynamic)

Conductor Color Coding

- Red, blue, or black insulation*, numbered
- 1 green/yellow green conductor
- 1 white-striped neutral (12 conductors or greater, except 14 AWG)

Materials

- Stranded bare copper conductors
- PVC/nylon insulation
- Black oil-resistant thermoplastic elastomer jacket

Features

- UL Sunlight Resistant
- UL Oil Res. I/II
- 10x bend radius
- Over 20 million rolling flex cycles
- Tic-tock and twist test per MIL-C-13777G
- Suitable for use in Class I, Division 2 locations per Article 501 of the National Electric Code

Availability

Bulk, cut to length

FIT® Tubing Recommendations

- FIT-600: Highly flexible, cross-linked elastomer
- FIT-650: Chemical- and temperature-resistant fluoroelastomer

14 AWG (2.11 mm²)

Stranding: 105/34 (105 x 0.16 mm)
Insulation thickness: 0.016 (0.41 mm) PVC/0.005 (0.10 mm) nylon

Part No.			Conductors	Nominal Diameter		Jacket Thickness	
Black Insul.	Blue Insul.	Red Insul.		Inch	mm	Inch	mm
F14004KW	F14004LW	F14004RW	4	0.398	10.11	0.050	1.27
F14005KW	F14005LW	F14005RW	5	0.434	11.02	0.050	1.27
F14007KW	F14007LW	F14007RW	7	0.539	13.69	0.065	1.65
F14012KW	F14012LW	F14012RW	12	0.628	15.95	0.065	1.65

12 AWG (3.38 mm²)

Stranding: 168/34 (168 x 0.16 mm)
Insulation thickness: 0.016 (0.41 mm) PVC/0.005 (0.10 mm) nylon

Part No.			Conductors	Nominal Diameter		Jacket Thickness	
Black Insul.	Blue Insul.	Red Insul.		Inch	mm	Inch	mm
F12004KW	F12004LW	F12004RW	4	0.501	12.73	0.065	1.65
F12005KW	F12005LW	F12005RW	5	0.545	13.84	0.065	1.65
F12007KW	F12007LW	F12007RW	7	0.640	16.26	0.065	1.65

10 AWG (5.32 mm²)

Stranding: 105/30 (105 x 0.25 mm)
Insulation thickness: 0.022 (0.56 mm) PVC/0.005 (0.10 mm) nylon

Part No.			Conductors	Nominal Diameter		Jacket Thickness	
Black Insul.	Blue Insul.	Red Insul.		Inch	mm	Inch	mm
F10004KW	F10004LW	F10004RW	4	0.565	14.35	0.065	1.65
F10005KW	F10005LW	F10005RW	5	0.618	15.70	0.065	1.65
F10007KW	F10007LW	F10007RW	7	0.729	18.52	0.065	1.65

8 AWG (8.51 mm²)

Stranding: 168/30 (168 x 0.25 mm)
Insulation thickness: 0.032 (0.81 mm) PVC/0.006 (0.15 mm) nylon

Part No.			Conductors	Nominal Diameter		Jacket Thickness	
Black Insul.	Blue Insul.	Red Insul.		Inch	mm	Inch	mm
F08004KW	F08004LW	F08004RW	4	0.740	18.80	0.065	1.65

*Red insulation: AC circuits operating at less than line voltage
Blue insulation: DC circuits operating at less than line voltage
Black insulation: AC circuits operating at less than line voltage



Series M Control Cable

Stationary or Minimal Flex Applications
600 V Unshielded, Multiconductor

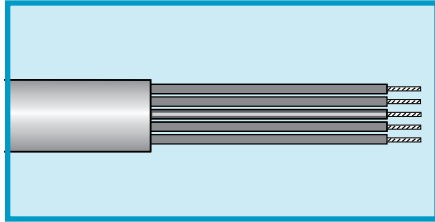

UL TC-ER
UL MTW
UL WTTC (1000 V)
UL PLTC (300 V)
CSA AWM I/II A/B FT4
CE LVD 73/23/EEC Amend.
93/68/EEC

Operating Temperature

- 25°C to +90°C (static)
- 5°C to +90°C (dynamic)

Conductor Color Coding

- Red, blue, or black insulation*, numbered
- 1 green/yellow green conductor
- 1 white-striped neutral
- (12 conductors or greater)

Materials

- Finely stranded bare copper conductors
- PVC/nylon insulation
- Slate PVC jacket

Features

- UL Sunlight Resistant
- UL Oil Res. I
- UL Direct Burial
- Suitable for use in Class I, Division 2 locations per Article 501 of the National Electric Code
- 90°C Dry/75°C Wet

Availability

Bulk, cut to length

FIT® Tubing Recommendations

- FIT-221: General-purpose cross-linked polyolefin
- FIT-321: Medium-wall, adhesive-lined cross-linked polyolefin

18 AWG (0.96 mm²)

Stranding: 19/30 (19 x 0.25 mm)
Insulation thickness: 0.016 (0.41 mm) PVC/0.005 (0.10 mm) nylon

Part No.			Conductors	Nominal Diameter		Jacket Thickness	
Black Insul.	Blue Insul.	Red Insul.		Inch	mm	Inch	mm
M18103KW	M18103LW	M18103RW	3	0.301	7.65	0.050	1.27
M18104KW	M18104LW	M18104RW	4	0.326	8.28	0.050	1.27
M18105KW	M18105LW	M18105RW	5	0.353	8.97	0.050	1.27
M18107KW	M18107LW	M18107RW	7	0.381	9.68	0.050	1.27
M18112KW	M18112LW	M18112RW	12	0.515	13.08	0.065	1.65
M18117KW	M18117LW	M18117RW	17	0.594	15.09	0.065	1.65
M18122KW	M18122LW	M18122RW	22	0.651	16.54	0.065	1.65
M18125KW	M18125LW	M18125RW	25	0.699	17.75	0.065	1.65
M18134KW	M18134LW	M18134RW	34	0.777	19.74	0.065	1.65
M18142KW	M18142LW	M18142RW	42	0.874	22.20	0.085	2.15
M18149KW	M18149LW	M18149RW	49	0.923	23.44	0.085	2.15
M18165KW	M18165LW	M18165RW	65	1.029	26.14	0.085	2.15

16 AWG (1.32 mm²)

Stranding: 26/30 (26 x 0.25 mm)
Insulation thickness: 0.016 (0.41 mm) PVC/0.005 (0.10 mm) nylon

Part No.			Conductors	Nominal Diameter		Jacket Thickness	
Black Insul.	Blue Insul.	Red Insul.		Inch	mm	Inch	mm
M16103KW	M16103LW	M16103RW	3	0.323	8.20	0.050	1.27
M16104KW	M16104LW	M16104RW	4	0.350	8.89	0.050	1.27
M16105KW	M16105LW	M16105RW	5	0.380	9.65	0.050	1.27
M16107KW	M16107LW	M16107RW	7	0.421	10.69	0.055	1.39
M16112KW	M16112LW	M16112RW	12	0.557	14.14	0.065	1.65
M16117KW	M16117LW	M16117RW	17	0.644	16.35	0.065	1.65
M16119KW	M16119LW	M16119RW	19	0.644	16.35	0.065	1.65
M16122KW	M16122LW	M16122RW	22	0.707	17.95	0.065	1.65
M16125KW	M16125LW	M16125RW	25	0.761	19.32	0.065	1.65
M16133KW	M16133LW	M16133RW	33	0.857	21.76	0.085	2.15
M16142KW	M16142LW	M16142RW	42	0.950	24.13	0.085	2.15
M16149KW	M16149LW	M16149RW	49	1.005	25.52	0.085	2.15
M16165KW	M16165LW	M16165RW	65	1.122	28.49	0.085	2.15

*Red insulation: AC circuits operating at less than line voltage
Blue insulation: DC circuits operating at less than line voltage
Black insulation: AC circuits operating at less than line voltage



Series M Control Cable

Stationary or Minimal Flex Applications
600 V Unshielded, Multiconductor

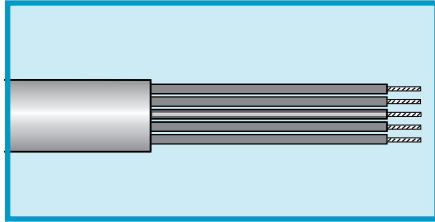

UL TC-ER
UL MTW
UL WTTC (1000 V)
UL PLTC (300 V)
CSA AWM I/II A/B FT4
CE LVD 73/23/EEC Amend.
93/68/EEC

Operating Temperature

- 25°C to +90°C (static)
- 5°C to +90°C (dynamic)

Conductor Color Coding

- Red, blue, or black insulation*, numbered
- 1 green/yellow green conductor
- 1 white-striped neutral
- (12 conductors or greater, except 14 AWG)

Materials

- Finely stranded bare copper conductors
- PVC/nylon insulation
- Slate PVC jacket

Features

- UL Sunlight Resistant
- UL Oil Res. I
- UL Direct Burial
- Suitable for use in Class I, Division 2 locations per Article 501 of the National Electric Code
- 90°C Dry/75°C Wet

Availability

Bulk, cut to length

FIT® Tubing Recommendations

- FIT-221: General-purpose cross-linked polyolefin
- FIT-321: Medium-wall, adhesive-lined cross-linked polyolefin



14 AWG (2.09 mm²)

Stranding: 41/30 (41 x 0.25 mm)
Insulation thickness: 0.016 (0.41 mm) PVC/0.005 (0.10 mm) nylon

Part No.			Conductors	Nominal Diameter		Jacket Thickness	
Black Insul.	Blue Insul.	Red Insul.		Inch	mm	Inch	mm
M14104KW	M14104LW	M14104RW	4	0.384	9.75	0.050	1.27
M14105KW	M14105LW	M14105RW	5	0.428	10.87	0.055	1.39
M14107KW	M14107LW	M14107RW	7	0.483	12.26	0.065	1.65
M14112KW	M14112LW	M14112RW	12	0.615	15.62	0.065	1.65
M14125KW	M14125LW	M14125RW	25	0.887	22.52	0.085	2.15

12 AWG (3.31 mm²)

Stranding: 65/30 (65 x 0.25 mm)
Insulation thickness: 0.016 (0.41 mm) PVC/0.005 (0.10 mm) nylon

Part No.			Conductors	Nominal Diameter		Jacket Thickness	
Black Insul.	Blue Insul.	Red Insul.		Inch	mm	Inch	mm
M12104KW	M12104LW	M12104RW	4	0.44	11.17	0.055	1.39
M12105KW	M12105LW	M12105RW	5	0.499	12.67	0.065	1.65
M12107KW	M12107LW	M12107RW	7	0.540	13.71	0.065	1.65

10 AWG (5.32 mm²)

Stranding: 105/30 (105 x 0.25 mm)
Insulation thickness: 0.022 (0.56 mm) PVC/0.005 (0.10 mm) nylon

Part No.			Conductors	Nominal Diameter		Jacket Thickness	
Black Insul.	Blue Insul.	Red Insul.		Inch	mm	Inch	mm
M10104KW	M10104LW	M10104RW	4	0.549	13.94	0.065	1.65
M10105KW	M10105LW	M10105RW	5	0.600	15.24	0.065	1.65
M10107KW	M10107LW	M10107RW	7	0.652	16.56	0.065	1.65

8 AWG (8.52 mm²)

Stranding: 168/30 (168 x 0.25 mm)
Insulation thickness: 0.032 (0.81 mm) PVC/0.006 (0.15 mm) nylon

Part No.			Conductors	Nominal Diameter		Jacket Thickness	
Black Insul.	Blue Insul.	Red Insul.		Inch	mm	Inch	mm
M08104KW	M08104LW	M08104RW	4	0.724	18.38	0.065	1.65
M08105KW	M08105LW	M08105RW	5	0.795	20.19	0.065	1.65

*Red insulation: AC circuits operating at less than line voltage
Blue insulation: DC circuits operating at less than line voltage
Black insulation: AC circuits operating at less than line voltage

Series P Enhanced Stationary Control Cable

Stationary or Minimal Flex Applications

600 V Unshielded, Multiconductor

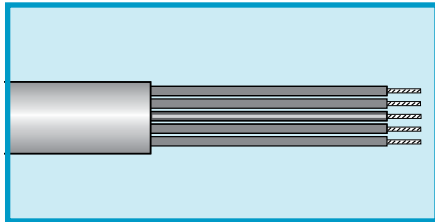

UL TC-ER, PLTC
UL TFFN (18 - 16 AWG)
UL THHN (14 - 8 AWG)
CSA AWM I/II A/B FT4
CE LVD 73/23/EEC Amend.
93/68/EEC

Operating Temperature

- 25°C to +90°C

Voltage Rating

- 600 V (TC-ER)
- 300 V (PLTC)

Conductor Color Coding

- Red, blue, or black insulation*, numbered
- 1 green/yellow green conductor
- 1 white-striped neutral
- (12 conductors or greater)

Materials

- Stranded bare copper conductors
- PVC/nylon insulation
- Oil-resistant thermoplastic elastomer jacket

Features

- UL Sunlight Resistant
- UL Oil Res. I/II
- 10x bend radius, static and dynamic
- Suitable for use in Class I, Division 2 locations per Article 501 of the National Electric Code

Availability

Bulk, cut to length

FIT® Tubing Recommendations

- FIT-600: Highly flexible cross-linked elastomer
- FIT-650: Chemical/temperature-resistant cross-linked fluoroelastomer

*Red insulation: AC circuits operating at less than line voltage
 Blue insulation: DC circuits operating at less than line voltage
 Black insulation: AC circuits operating at less than line voltage

18 AWG (0.96 mm²)

Stranding: 19/30 (19 x 0.25 mm)
 Insulation thickness: 0.016 (0.41 mm) PVC/0.005 (0.010 mm) nylon

Part No.			Conductors	Nominal Diameter		Jacket Thickness	
Black Insul.	Blue Insul.	Red Insul.		Inch	mm	Inch	mm
MP18103KW	MP18103LW	MP18103RW	3	0.313	7.95	0.050	1.27
MP18104KW	MP18104LW	MP18104RW	4	0.338	8.58	0.050	1.27
MP18105KW	MP18105LW	MP18105RW	5	0.365	9.27	0.050	1.27
MP18107KW	MP18107LW	MP18107RW	7	0.393	9.98	0.050	1.27
MP18112KW	MP18112LW	MP18112RW	12	0.527	13.39	0.065	1.65
MP18117KW	MP18117LW	MP18117RW	17	0.606	15.39	0.065	1.65
MP18122KW	MP18122LW	MP18122RW	22	0.663	16.84	0.065	1.65
MP18125KW	MP18125LW	MP18125RW	25	0.711	18.06	0.065	1.65
MP18134KW	MP18134LW	MP18134RW	34	0.789	20.04	0.065	1.65
MP18142KW	MP18142LW	MP18142RW	42	0.886	22.50	0.085	2.16
MP18149KW	MP18149LW	MP18149RW	49	0.935	23.75	0.085	2.16
MP18165KW	MP18165LW	MP18165RW	65	1.041	26.44	0.085	2.16

16 AWG (1.32 mm²)

Stranding: 26/30 (26 x 0.25 mm)
 Insulation thickness: 0.016 (0.41mm) PVC/0.005 (0.010 mm) nylon

Part No.			Conductors	Nominal Diameter		Jacket Thickness	
Black Insul.	Blue Insul.	Red Insul.		Inch	mm	Inch	mm
MP16103KW	MP16103LW	MP16103RW	3	0.335	8.51	0.050	1.27
MP16104KW	MP16104LW	MP16104RW	4	0.362	9.19	0.050	1.27
MP16105KW	MP16105LW	MP16105RW	5	0.392	9.96	0.050	1.27
MP16107KW	MP16107LW	MP16107RW	7	0.423	10.74	0.050	1.27
MP16112KW	MP16112LW	MP16112RW	12	0.569	14.45	0.065	1.65
MP16117KW	MP16117LW	MP16117RW	17	0.656	16.66	0.065	1.65
MP16122KW	MP16122LW	MP16122RW	22	0.719	18.26	0.065	1.65
MP16125KW	MP16125LW	MP16125RW	25	0.773	19.63	0.065	1.65
MP16133KW	MP16133LW	MP16133RW	33	0.869	22.07	0.085	2.16
MP16142KW	MP16142LW	MP16142RW	42	0.962	24.43	0.085	2.16
MP16149KW	MP16149LW	MP16149RW	49	1.017	25.83	0.085	2.16
MP16165KW	MP16165LW	MP16165RW	65	1.134	28.80	0.085	2.16



Series P Enhanced Stationary Control Cable

Stationary or Minimal Flex Applications
600 V Unshielded, Multiconductor

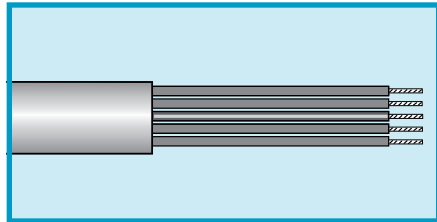

UL TC-ER, PLTC
UL TFFN (18 - 16 AWG)
UL THHN (14 - 8 AWG)
CSA AWM I/II A/B FT4
CE LVD 73/23/EEC Amend.
93/68/EEC

Operating Temperature

- 25°C to +90°C

Voltage Rating

- 600 V (TC-ER)
- 300 V (PLTC)

Conductor Color Coding

- Red, blue, or black insulation*, numbered
- 1 green/yellow green conductor
- 1 white-striped neutral
- (12 conductors or greater)

Materials

- Stranded bare copper conductors
- PVC/nylon insulation
- Oil-resistant thermoplastic elastomer jacket

Features

- UL Sunlight Resistant
- UL Oil Res. I/II
- 10x bend radius, static and dynamic
- Suitable for use in Class I, Division 2 locations per Article 501 of the National Electric Code

Availability

Bulk, cut to length

FIT® Tubing Recommendations

- FIT-600: Highly flexible cross-linked elastomer
- FIT-650: Chemical/temperature-resistant cross-linked fluoroelastomer

*Red insulation: AC circuits operating at less than line voltage
Blue insulation: DC circuits operating at less than line voltage
Black insulation: AC circuits operating at less than line voltage

14 AWG (2.08 mm²)

Stranding: 41/30 (41 x 0.25 mm)
Insulation thickness: 0.016 (0.41 mm) PVC/0.005 (0.010 mm) nylon

Part No.			Conductors	Nominal Diameter		Jacket Thickness	
Black Insul.	Blue Insul.	Red Insul.		Inch	mm	Inch	mm
MP14104KW	MP14104LW	MP14104RW	4	0.396	10.06	0.050	1.27
MP14105KW	MP14105LW	MP14105RW	5	0.430	10.92	0.050	1.27
MP14107KW	MP14107LW	MP14107RW	7	0.495	12.57	0.065	1.65
MP14112KW	MP14112LW	MP14112RW	12	0.627	15.93	0.065	1.65
MP14125KW	MP14125LW	MP14125RW	25	0.899	22.83	0.085	2.16

12 AWG (3.31 mm²)

Stranding: 65/30 (65 x 0.25 mm)
Insulation thickness: 0.016 (0.41 mm) PVC/0.005 (0.010 mm) nylon

Part No.			Conductors	Nominal Diameter		Jacket Thickness	
Black Insul.	Blue Insul.	Red Insul.		Inch	mm	Inch	mm
MP12104KW	MP12104LW	MP12104RW	4	0.472	11.99	0.065	1.65
MP12105KW	MP12105LW	MP12105RW	5	0.511	12.98	0.065	1.65
MP12107KW	MP12107LW	MP12107RW	7	0.552	14.02	0.065	1.65

10 AWG (5.32 mm²)

Stranding: 105/30 (105 x 0.25 mm)
Insulation thickness: 0.022 (0.56 mm) PVC/0.005 (0.010 mm) nylon

Part No.			Conductors	Nominal Diameter		Jacket Thickness	
Black Insul.	Blue Insul.	Red Insul.		Inch	mm	Inch	mm
MP10104KW	MP10104LW	MP10104RW	4	0.561	14.25	0.065	1.65
MP10105KW	MP10105LW	MP10105RW	5	0.612	15.54	0.065	1.65
MP10107KW	MP10107LW	MP10107RW	7	0.664	16.87	0.065	1.65

8 AWG (8.52 mm²)

Stranding: 168/30 (105 x 0.25 mm)
Insulation thickness: 0.032 (0.81 mm) PVC/0.005 (0.010 mm) nylon

Part No.			Conductors	Nominal Diameter		Jacket Thickness	
Black Insul.	Blue Insul.	Red Insul.		Inch	mm	Inch	mm
MP08104KW	MP08104LW	MP08104RW	4	0.736	18.69	0.065	1.65
MP08105KW	MP08105LW	MP08105RW	5	0.807	20.50	0.065	1.65



Series SF Flexible Servo Cable

600/1000 V, PVC/Nylon, TPE

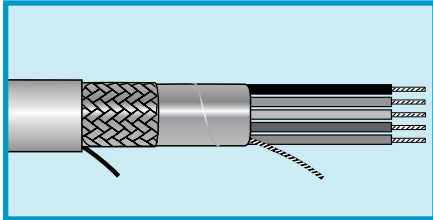

UL TC-ER (600 V)
UL WTTTC (1000 V)
CSA AWM I/II A/B FT4

Operating Temperature

- -25°C to +90°C (static)
- -5°C to +90°C (dynamic)

Conductor Color Coding

- Chart KX (page 534) for multiconductor
- Chart A (page 528) for pairs

Materials

- Stranded tinned copper conductors
- PVC/nylon insulation
- Foil + braid shielding
Aluminum/polyester foil
Tinned copper braid,
85% coverage
- Orange thermoplastic elastomer jacket

Features

- UL Sunlight Resistant
- UL Oil Res. I/II
- 10x bend radius
- Two configurations
 1. Power cable
 2. Composite cable for power and control
- Suitable for use in Class I, Division 2 locations per Article 501 of the National Electric Code

Availability

Bulk, cut to length

FIT® Tubing Recommendations

- FIT-600: Highly flexible cross-linked elastomer
- FIT-650: Chemical/temperature-resistant cross-linked fluoroelastomer

Flexible Power Servo Cable

4 conductors for power/ground

Part No.	Conductors	Wire Size		Stranding		Nominal Diameter		Jacket Thickness	
		AWG	mm ²	AWG	mm	Inch	mm	Inch	mm
SF61118CY	4	18	0.96	19/30	19 x 0.25	0.382	9.70	0.055	1.40
SF61116CY	4	16	1.32	26/30	26 x 0.25	0.406	10.31	0.055	1.40
SF61114CY	4	14	2.09	41/30	41 x 0.25	0.440	11.18	0.055	1.40
SF61112CY	4	12	3.31	65/30	65 x 0.25	0.506	12.85	0.065	1.65
SF61110CY	4	10	5.32	105/30	105 x 0.25	0.603	15.32	0.065	1.65
SF61108CY	4	8	8.50	168/30	168 x 0.25	0.785	19.94	0.065	1.65

Flexible Composite Servo Cable

4 conductors for power/ground +2 individually shielded pairs for brake or temperature control

Part No.	Conductors	Wire Size		Stranding		Nominal Diameter		Jacket Thickness	
		AWG	mm ²	AWG	mm	Inch	mm	Inch	mm
SF61220CY	4 +2 pairs	16 pwr 18 pr	1.32 0.96	26/30 19/30	26 x 0.25 19 x 0.25	0.590	14.99	0.065	1.65
SF61221CY	4 +2 pairs	14 pwr 18 pr	2.09 0.96	41/30 19/30	41 x 0.25 19 x 0.25	0.618	15.70	0.065	1.65
SF61222CY	4 +2 pairs	12 pwr 16 pr	3.31 1.32	65/30 26/30	65 x 0.25 26 x 0.25	0.674	17.12	0.065	1.65
SF61223CY	4 +2 pairs	10 pwr 16 pr	5.37 1.32	105/30 26/30	105 x 0.25 26 x 0.25	0.757	19.23	0.065	1.65
SF61224CY	4 +2 pairs	8 pwr 16 pr	8.50 1.32	168/30 26/30	168 x 0.25 26 x 0.25	0.943	23.95	0.085	2.16



Series V VFD Control Cables

Enhanced Design for Superior Performance in Variable-Frequency Drives
600/1000 V Shielded

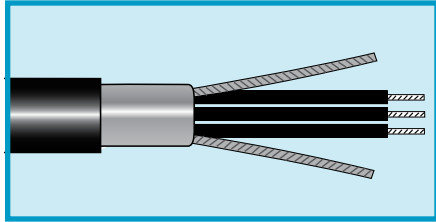

Series V cables for variable-frequency drives (VFD) set the standard in high-performance and reliable connectivity. Their specially formulated cross-linked polyethylene insulation provides superior corona resistance, low capacitance for longer runs, and excellent low-temperature properties.

A symmetrical design places the ground wires in the interstices of the conductors for uniform conductor-to-ground capacitance and impedance.

Smaller gauge cable feature a combination foil/braid shield to offer exceptional EMI/RFI protection in noisy environments. On larger gauge cable, a double copper tape is used to provide the same noise-free operation.

This uniformity reduces the probability of motor damage from common-mode current.

Alpha Series V VFD cables are compatible with drives from all major manufacturers.

UL RHW-2 (16 – 2 AWG)
UL XHHW-2
UL TC-ER
UL 1000V Flexible Motor Supply Cable
CSA AWM I/II A/B FT4
CE LVD 73/23/EEC
Amendment 93/68/EEC
Pennsylvania MHSA

Operating Temperature

- -40°C to +90°C

Conductor Color Coding

- Black, numbered

Materials

- Stranded tinned copper conductors
- Stranded tinned copper ground wires
- Cross-linked polyethylene insulation

- Shielding
16 – 4 AWG:
Aluminum/polyester/aluminum foil and tinned copper braid with 85% coverage
2 – 4/0 AWG:
Double-layer copper tape
- Black premium PVC jacket

Voltage

- 600 V (UL TC-ER)
- 1000 V (UL Motor Supply)

Features

- UL Direct Burial
- UL Sunlight Resistant
- 10x bend radius
- Suitable for use in Class I, Division 2 locations per Article 501 of the National Electric Code

Availability

Bulk, made to order

FIT® Tubing Recommendations

- FIT-221: General-purpose cross-linked polyolefin
- FIT-321V: Low-shrink-temperature, flame-retardant cross-linked polyolefin

Three-Conductor VFD Cables											
Part No.	Wire Size		Stranding		Shielding	Insulation Thickness		Jacket Thickness		Nominal Diameter	
	AWG	mm ²	AWG	mm		Inch	mm	Inch	mm	Inch	mm
V16316	16	1.32	26/30	26 x 0.25	Foil/Braid	0.046	1.17	0.050	1.27	0.468	11.89
V16314	14	2.09	41/30	41 x 0.25	Foil/Braid	0.046	1.17	0.065	1.65	0.538	13.67
V16312	12	3.31	65/30	65 x 0.25	Foil/Braid	0.046	1.17	0.065	1.65	0.578	14.68
V16310	10	5.37	105/30	105 x 0.25	Foil/Braid	0.047	1.19	0.065	1.65	0.642	16.31
V16308	8	8.53	133/29	133 x 0.28	Foil/Braid	0.061	1.55	0.065	1.65	0.798	20.27
V16306	6	13.57	133/27	133 x 0.36	Foil/Braid	0.061	1.55	0.085	2.15	0.924	23.47
V16304	4	21.58	133/25	133 x 0.45	Foil/Braid	0.061	1.55	0.085	2.15	1.050	26.67
V16302	2	34.32	133/23	133 x 0.57	Tape	0.061	1.55	0.085	2.15	1.157	29.39
V16001	1	43.28	133/22	133 x 0.64	Tape	0.056	1.42	0.085	2.15	1.197	30.48
V16000	1/0	54.58	133/21	133 x 0.72	Tape	0.056	1.42	0.085	2.15	1.294	32.77
V16020	2/0	68.85	133/20	133 x 0.81	Tape	0.056	1.42	0.085	2.15	1.399	35.56
V16030	3/0	86.9	133/19	133 x 0.91	Tape	0.056	1.42	0.085	2.15	1.517	38.53
V16040	4/0	109	133/18	133 x 1.02	Tape	0.056	1.42	0.085	2.15	1.653	41.98



Series V VFD Control Cables

Enhanced Design for Superior Performance in Variable-Frequency Drives
600/1000 V Shielded

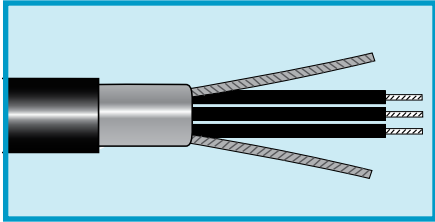

Series V cables for variable-frequency drives (VFD) set the standard in high-performance and reliable connectivity. Their specially formulated cross-linked polyethylene insulation provides superior corona resistance, low capacitance for longer runs, and excellent low-temperature properties.

A symmetrical design places the ground wires in the interstices of the conductors for uniform conductor-to-ground capacitance and impedance.

Smaller gauge cable feature a combination foil/braid shield to offer exceptional EMI/RFI protection in noisy environments. On larger gauge cable, a double copper tape is used to provide the same noise-free operation.

This uniformity reduces the probability of motor damage from common-mode current.

Alpha Series V VFD cables are compatible with drives from all major manufacturers.

UL RHW-2 (16 - 2 AWG)
UL XHHW-2
UL TC-ER
UL 1000V Flexible Motor Supply Cable
CSA AWM I/II A/B FT4
CE LVD 73/23/EEC
Amendment 93/68/EEC
Pennsylvania MHSA

Operating Temperature

- 40°C to +90°C

Conductor Color Coding

- Black, numbered

Materials

- Stranded tinned copper conductors
- Stranded tinned copper ground wires
- Cross-linked polyethylene insulation

- Shielding
16 - 4 AWG:
Aluminum/polyester/aluminum foil and tinned copper braid with 85% coverage
2 - 4/0 AWG:
Double-layer copper tape
- Black premium PVC jacket

Voltage

- 600 V (UL TC-ER)
- 1000 V (UL Motor Supply)

Features

- UL Direct Burial
- UL Sunlight Resistant
- 10x bend radius
- Suitable for use in Class I, Division 2 locations per Article 501 of the National Electric Code

Availability

Bulk, made to order

FIT® Tubing Recommendations

- FIT-221: General-purpose cross-linked polyolefin
- FIT-321V: Low-shrink-temperature, flame-retardant cross-linked polyolefin

Four-Conductor VFD Cable

Part No.	Wire Size		Stranding		Shielding	Insulation Thickness		Jacket Thickness		Nominal Diameter	
	AWG	mm ²	AWG	mm		Inch	mm	Inch	mm	Inch	mm
V16016	16	1.32	26/30	26 x 0.25	Foil/Braid	0.047	1.19	0.065	1.65	0.547	13.89
V16014	14	2.09	41/30	41 x 0.25	Foil/Braid	0.047	1.19	0.065	1.65	0.584	14.83
V16012	12	3.31	65/30	65 x 0.25	Foil/Braid	0.047	1.19	0.065	1.65	0.633	16.08
V16010	10	5.37	105/30	105 x 0.25	Foil/Braid	0.047	1.19	0.085	2.15	0.746	18.95
V16008	8	8.53	133/29	133 x 0.28	Foil/Braid	0.061	1.55	0.086	2.15	0.920	23.37
V16006	6	13.57	133/27	133 x 0.36	Foil/Braid	0.061	1.55	0.086	2.15	1.017	25.83
V16004	4	21.58	133/25	133 x 0.45	Foil/Braid	0.061	1.55	0.086	2.15	1.157	29.39
V16002	2	34.32	133/23	133 x 0.57	Foil/Braid	0.061	1.55	0.088	2.15	1.308	33.22

Four-Conductor VFD Cable with 14 AWG (2.09) Brake Pair

Part No.	Wire Size		Stranding		Shielding	Insulation Thickness		Jacket Thickness		Nominal Diameter	
	AWG	mm ²	AWG	mm		Inch	mm	Inch	mm	Inch	mm
V16116	16	1.32	26/30	26 x 0.25	Foil/Braid	0.047	1.19	0.065	1.65	0.717	18.21
V16114	14	2.09	41/30	41 x 0.25	Foil/Braid	0.047	1.19	0.065	1.65	0.743	18.87
V16112	12	3.31	65/30	65 x 0.25	Foil/Braid	0.047	1.19	0.065	1.65	0.785	19.94
V16110	10	5.37	105/30	105 x 0.25	Foil/Braid	0.047	1.19	0.085	2.15	0.875	22.23
V16108	8	8.53	133/29	133 x 0.28	Foil/Braid	0.061	1.55	0.085	2.15	1.032	26.21



Series XM Flexible Control Cable

600/1000 V Unshielded, PVC/Nylon, PVC

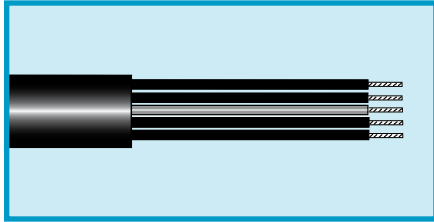

Series XM Flexible Control Cable is the ideal choice for medium-to-high-flex applications. Featuring a premium-grade PVC jacket, Series XM offers a durable, oil-resistant construction that prevents contamination from hazardous fluids and protects against abrasion. Plus, its optimum flexibility and performance allows it to support a variety of industrial applications.

UL TC-ER (600 V)
UL WTTT (1000 V)
UL MTW (600 V)
CSA AWM I/II A/B FT4
CE compliant

Operating Temperature

-30°C to +90°C (static)
 -5°C to +90°C (dynamic)

Conductor Color Coding

- Chart KW, RW, LW (pages 533-535)
- Black, blue, or red* numbered conductors with one green/yellow ground conductor

Materials

- Stranded bare copper conductors
- PVC/nylon insulation
- Black PVC jacket

Features

- UL Oil Res. I
- UL Sunlight Resistant
- Suitable for NFPA 79 application

Availability

Bulk, cut to length

FIT® Tubing Recommendations

- FIT-600: Highly flexible cross-linked elastomer
- FIT-650: Chemical- and temperature-resistant fluoroelastomer

*Red insulation: AC circuits operating at less than line voltage
 Blue insulation: DC circuits operating at less than line voltage
 Black insulation: AC circuits operating at less than line voltage

18 AWG (0.83 mm²)

Stranding: 41/34 (41 x 0.16 mm)
 Insulation thickness: 0.016 (0.41 mm) PVC/0.005 (0.13 mm) nylon

Part No.			Conductors	Nominal Diameter		Jacket Thickness	
Red	Blue	Black		Inch	mm	Inch	mm
XM1803R	XM1803L	XM1803K	3	0.308	7.82	0.050	1.27
XM1804R	XM1804L	XM1804K	4	0.333	8.46	0.050	1.27
XM1805R	XM1805L	XM1805K	5	0.360	9.14	0.050	1.27
XM1807R	XM1807L	XM1807K	7	0.418	10.62	0.050	1.27
XM1812R	XM1812L	XM1812K	12	0.485	12.32	0.050	1.27
XM1817R	XM1817L	XM1817K	17	0.597	15.16	0.065	1.65
XM1822R	XM1822L	XM1822K	22	0.656	16.66	0.065	1.65
XM1825R	XM1825L	XM1825K	25	0.717	18.21	0.065	1.65
XM1834R	XM1834L	XM1834K	34	0.775	19.69	0.065	1.65
XM1842R	XM1842L	XM1842K	42	0.874	22.20	0.085	2.16
XM1849R	XM1849L	XM1849K	49	0.965	24.51	0.085	2.16
XM1865R	XM1865L	XM1865K	65	1.052	26.72	0.085	2.16

16 AWG (1.31 mm²)

Stranding: 65/34 (65 x 0.16 mm)
 Insulation thickness: 0.016 (0.41 mm) PVC/0.005 (0.13 mm) nylon

Part No.			Conductors	Nominal Diameter		Jacket Thickness	
Red	Blue	Black		Inch	mm	Inch	mm
XM1603R	XM1603L	XM1603K	3	0.334	8.48	0.050	1.27
XM1604R	XM1604L	XM1604K	4	0.362	9.19	0.050	1.27
XM1605R	XM1605L	XM1605K	5	0.393	9.98	0.050	1.27
XM1607R	XM1607L	XM1607K	7	0.459	11.66	0.050	1.27
XM1612R	XM1612L	XM1612K	12	0.565	14.35	0.065	1.65
XM1617R	XM1617L	XM1617K	17	0.657	16.69	0.065	1.65
XM1619R	XM1619L	XM1619K	19	0.691	17.55	0.065	1.65
XM1622R	XM1622L	XM1622K	22	0.724	18.39	0.065	1.65
XM1625R	XM1625L	XM1625K	25	0.793	20.14	0.065	1.65
XM1633R	XM1633L	XM1633K	33	0.899	22.83	0.085	2.16
XM1642R	XM1642L	XM1642K	42	0.966	24.54	0.085	2.16
XM1649R	XM1649L	XM1649K	49	1.069	27.15	0.085	2.16

14 AWG (2.11 mm²)

Stranding: 105/34 (105 x 0.16 mm)
 Insulation thickness: 0.016 (0.41 mm) PVC/0.005 (0.13 mm) nylon

Part No.			Conductors	Nominal Diameter		Jacket Thickness	
Red	Blue	Black		Inch	mm	Inch	mm
XM1403R	XM1403L	XM1403K	3	0.366	9.30	0.050	1.27
XM1404R	XM1404L	XM1404K	4	0.398	10.11	0.050	1.27
XM1405R	XM1405L	XM1405K	5	0.464	11.79	0.065	1.65
XM1407R	XM1407L	XM1407K	7	0.539	13.69	0.065	1.65
XM1412R	XM1412L	XM1412K	12	0.627	15.93	0.065	1.65



Series XM Flexible Control Cable

600/1000 V Unshielded, PVC/Nylon, PVC

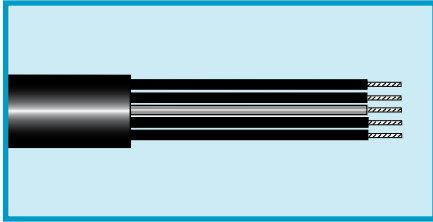

Series XM Flexible Control Cable is the ideal choice for medium-to-high-flex applications. Featuring a premium-grade PVC jacket, Series XM offers a durable, oil-resistant construction that prevents contamination from hazardous fluids and protects against abrasion. Plus, its optimum flexibility and performance allows it to support a variety of industrial applications.

UL TC-ER (600 V)
UL WTTTC (1000 V)
UL MTW (600 V)
CSA AWM I/II A/B FT4
CE compliant

Operating Temperature

-30°C to +90°C (static)
 -5°C to +90°C (dynamic)

Conductor Color Coding

- Chart KW, RW, LW (pages 533-535)
- Black, blue, or red* numbered conductors with one green/ yellow ground conductor

Materials

- Stranded bare copper conductors
- PVC/nylon insulation
- Black PVC jacket

Features

- UL Oil Res. I
- UL Sunlight Resistant
- Suitable for NFPA 79 application

Availability

Bulk, cut to length

FIT® Tubing Recommendations

- FIT-600: Highly flexible cross-linked elastomer
- FIT-650: Chemical- and temperature-resistant fluoroelastomer

*Red insulation: AC circuits operating at less than line voltage
 Blue insulation: DC circuits operating at less than line voltage
 Black insulation: AC circuits operating at less than line voltage

12 AWG (3.38 mm²)

Stranding: 168/34 (168 x 0.16 mm)
 Insulation thickness: 0.016 (0.41 mm) PVC/0.005 (0.13 mm) nylon

Part No.			Conductors	Nominal Diameter		Jacket Thickness	
Red	Blue	Black		Inch	mm	Inch	mm
XM1203R	XM1203L	XM1203K	3	0.431	10.95	0.050	1.27
XM1204R	XM1204L	XM1204K	4	0.501	12.73	0.065	1.65
XM1205R	XM1205L	XM1205K	5	0.545	13.84	0.065	1.65
XM1207R	XM1207L	XM1207K	7	0.640	16.26	0.065	1.65

10 AWG (5.32 mm²)

Stranding: 105/30 (105 x 0.25 mm)
 Insulation thickness: 0.022 (0.56 mm) PVC/0.005 (0.10 mm) nylon

Part No.			Conductors	Nominal Diameter		Jacket Thickness	
Red	Blue	Black		Inch	mm	Inch	mm
XM1003R	XM1003L	XM1003K	3	0.487	12.37	0.050	1.27
XM1004R	XM1004L	XM1004K	4	0.565	14.35	0.065	1.65
XM1005R	XM1005L	XM1005K	5	0.618	15.70	0.065	1.65
XM1007R	XM1007L	XM1007K	7	0.729	18.52	0.065	1.65

8 AWG (8.51 mm²)

Stranding: 168/30 (168 x 0.25 mm)
 Insulation thickness: 0.032 (0.81 mm) PVC/0.006 (0.15 mm) nylon

Part No.			Conductors	Nominal Diameter		Jacket Thickness	
Red	Blue	Black		Inch	mm	Inch	mm
XM0803R	XM0803L	XM0803K	3	0.671	17.04	0.065	1.65
XM0804R	XM0804L	XM0804K	4	0.737	18.72	0.065	1.65



Series XM Flexible Control Cable

600/1000 V Braid Shielded, PVC/Nylon, PVC

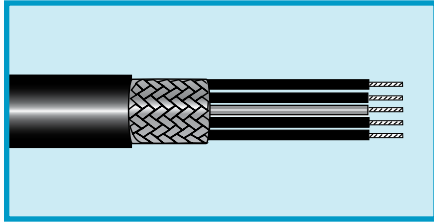

Series XM Flexible Control Cable is the ideal choice for medium-to-high-flex applications. Featuring a premium-grade PVC jacket, Series XM offers a durable, oil-resistant construction that prevents contamination from hazardous fluids and protects against abrasion. Plus, its optimum flexibility and performance allows it to support a variety of industrial applications.

UL TC-ER (600 V)
UL WTTT (1000 V)
UL MTW (600 V)
CSA AWM I/II A/B FT4
CE compliant

Operating Temperature

-30°C to +90°C (static)
 -5°C to +90°C (dynamic)

Conductor Color Coding

- Chart KW, RW, LW (pages 533-535)
- Black, blue, or red* numbered conductors with one green/yellow ground conductor

Materials

- Stranded bare copper conductors
- PVC/nylon insulation
- Tinned copper braid shield, 85% coverage
- Black PVC jacket

Features

- UL Oil Res. I
- UL Sunlight Resistant
- Suitable for NFPA 79 application

Availability

Bulk, cut to length

FIT® Tubing Recommendations

- FIT-600: Highly flexible cross-linked elastomer
- FIT-650: Chemical- and temperature-resistant fluoroelastomer

18 AWG (0.83 mm²)

Stranding: 41/34 (41 x 0.16 mm)
 Insulation thickness: 0.016 (0.41 mm) PVC/0.005 (0.13 mm) nylon

Part No.			Conductors	Nominal Diameter		Jacket Thickness	
Red	Blue	Black		Inch	mm	Inch	mm
XM1803RCY	XM1803LCY	XM1803KCY	3	0.336	8.53	0.050	1.27
XM1804RCY	XM1804LCY	XM1804KCY	4	0.361	9.17	0.050	1.27
XM1805RCY	XM1805LCY	XM1805KCY	5	0.388	9.86	0.050	1.27
XM1807RCY	XM1807LCY	XM1807KCY	7	0.446	11.33	0.050	1.27
XM1812RCY	XM1812LCY	XM1812KCY	12	0.549	13.94	0.050	1.27
XM1817RCY	XM1817LCY	XM1817KCY	17	0.631	16.03	0.065	1.65
XM1822RCY	XM1822LCY	XM1822KCY	22	0.697	17.70	0.065	1.65
XM1825RCY	XM1825LCY	XM1825KCY	25	0.758	19.25	0.065	1.65
XM1834RCY	XM1834LCY	XM1834KCY	34	0.856	21.74	0.065	1.65
XM1842RCY	XM1842LCY	XM1842KCY	42	0.915	23.24	0.085	2.16
XM1849RCY	XM1849LCY	XM1849KCY	49	1.006	25.55	0.085	2.16

16 AWG (1.31 mm²)

Stranding: 65/34 (65 x 0.16 mm)
 Insulation thickness: 0.016 (0.41 mm) PVC/0.005 (0.13 mm) nylon

Part No.			Conductors	Nominal Diameter		Jacket Thickness	
Red	Blue	Black		Inch	mm	Inch	mm
XM1603RCY	XM1603LCY	XM1603KCY	3	0.362	9.19	0.050	1.27
XM1604RCY	XM1604LCY	XM1604KCY	4	0.390	9.91	0.050	1.27
XM1605RCY	XM1605LCY	XM1605KCY	5	0.421	10.69	0.050	1.27
XM1607RCY	XM1607LCY	XM1607KCY	7	0.517	13.13	0.050	1.27
XM1612RCY	XM1612LCY	XM1612KCY	12	0.599	15.21	0.065	1.65
XM1617RCY	XM1617LCY	XM1617KCY	17	0.698	17.73	0.065	1.65
XM1619RCY	XM1619LCY	XM1619KCY	19	0.732	18.59	0.065	1.65
XM1622RCY	XM1622LCY	XM1622KCY	22	0.765	19.43	0.065	1.65
XM1625RCY	XM1625LCY	XM1625KCY	25	0.874	22.20	0.065	1.65
XM1633RCY	XM1633LCY	XM1633KCY	33	0.940	23.88	0.085	2.16
XM1642RCY	XM1642LCY	XM1642KCY	42	1.007	25.58	0.085	2.16
XM1649RCY	XM1649LCY	XM1649KCY	49	1.110	28.19	0.085	2.16

14 AWG (2.11 mm²)

Stranding: 105/34 (105 x 0.16 mm)
 Insulation thickness: 0.016 (0.41 mm) PVC/0.005 (0.13 mm) nylon

Part No.			Conductors	Nominal Diameter		Jacket Thickness	
Red	Blue	Black		Inch	mm	Inch	mm
XM1403RCY	XM1403LCY	XM1403KCY	3	0.394	10.01	0.050	1.27
XM1404RCY	XM1404LCY	XM1404KCY	4	0.426	10.82	0.050	1.27
XM1405RCY	XM1405LCY	XM1405KCY	5	0.492	12.50	0.065	1.65
XM1407RCY	XM1407LCY	XM1407KCY	7	0.573	14.55	0.065	1.65
XM1412RCY	XM1412LCY	XM1412KCY	12	0.661	16.79	0.065	1.65

*Red insulation: AC circuits operating at less than line voltage
 Blue insulation: DC circuits operating at less than line voltage
 Black insulation: AC circuits operating at less than line voltage



Series XM Flexible Control Cable

600/1000 V Braid Shielded, PVC/Nylon, PVC

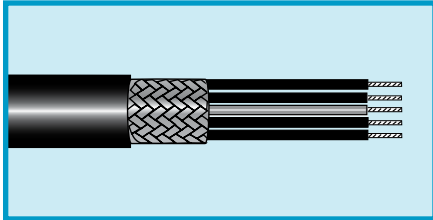

Series XM Flexible Control Cable is the ideal choice for medium-to-high-flex applications. Featuring a premium-grade PVC jacket, Series XM offers a durable, oil-resistant construction that prevents contamination from hazardous fluids and protects against abrasion. Plus, its optimum flexibility and performance allows it to support a variety of industrial applications.

UL TC-ER (600 V)
UL WTTTC (1000 V)
UL MTW (600 V)
CSA AWM I/II A/B FT4
CE compliant

Operating Temperature

-30°C to +90°C (static)
 -5°C to +90°C (dynamic)

Conductor Color Coding

- Chart KW, RW, LW (pages 533-535)
- Black, blue, or red* numbered conductors with one green/yellow ground conductor

Materials

- Stranded bare copper conductors
- PVC/nylon insulation
- Tinned copper braid shield, 85% coverage
- Black PVC jacket

Features

- UL Oil Res. I
- UL Sunlight Resistant
- Suitable for NFPA 79 application

Availability

Bulk, cut to length

FIT® Tubing Recommendations

- FIT-600: Highly flexible cross-linked elastomer
- FIT-650: Chemical- and temperature-resistant fluoroelastomer

12 AWG (3.38 mm ²)							
Stranding 168/34 (168 x 0.16 mm)							
Insulation thickness: 0.016 (0.41 mm) PVC/0.005 (0.13 mm) nylon							
Part No.			Conductors	Nominal Diameter		Jacket Thickness	
Red	Blue	Black		Inch	mm	Inch	mm
XM1203RCY	XM1203LCY	XM1203KCY	3	0.459	11.66	0.050	1.27
XM1204RCY	XM1204LCY	XM1204KCY	4	0.529	13.44	0.065	1.65
XM1205RCY	XM1205LCY	XM1205KCY	5	0.579	14.71	0.065	1.65
XM1207RCY	XM1207LCY	XM1207KCY	7	0.674	17.12	0.065	1.65

10 AWG (5.32 mm ²)							
Stranding: 105/30 (105 x 0.25 mm)							
Insulation thickness: 0.022 (0.56 mm) PVC/0.005 (0.13 mm) nylon							
Part No.			Conductors	Nominal Diameter		Jacket Thickness	
Red	Blue	Black		Inch	mm	Inch	mm
XM1003RCY	XM1003LCY	XM1003KCY	3	0.551	14.00	0.050	1.27
XM1004RCY	XM1004LCY	XM1004KCY	4	0.599	15.21	0.065	1.65
XM1005RCY	XM1005LCY	XM1005KCY	5	0.652	16.56	0.065	1.65
XM1007RCY	XM1007LCY	XM1007KCY	7	0.770	19.56	0.065	1.65

8 AWG (8.51 mm ²)							
Stranding: 168/30 (168 x 0.25 mm)							
Insulation thickness: 0.032 (0.81 mm) PVC/0.006 (0.15 mm) nylon							
Part No.			Conductors	Nominal Diameter		Jacket Thickness	
Red	Blue	Black		Inch	mm	Inch	mm
XM0803RCY	XM0803LCY	XM0803KCY	3	0.712	18.08	0.065	1.65
XM0804RCY	XM0804LCY	XM0804KCY	4	0.778	19.76	0.065	1.65

*Red insulation: AC circuits operating at less than line voltage
 Blue insulation: DC circuits operating at less than line voltage
 Black insulation: AC circuits operating at less than line voltage



The Right Cable . . . Just the Way You Want It

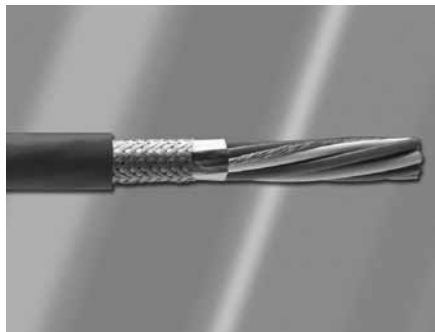

Custom Cable as Custom as Your Application!

Alpha Wire has a long heritage of supplying a wide range of wire, cable, tubing, and accessories for varying applications. We understand that despite the breadth and depth of our product portfolio, sometimes you require a cable as unique as the application. We make it easy to configure a custom cable.

We can also help you fashion the perfect cable to meet application parameters. The Alpha Wire Cable Design Center® allows you to quickly and easily modify any standard Alpha cable specification to your own application requirements. Count on the cable and application experts at Alpha Wire for guidance.

With our quick quotes and fast production turnaround, we will have your custom cable to you in no time.

- Meet special application requirements
- Increase system reliability with application-specific configurations
- Speed installation by reducing the number of different cables needed
- Get the best match of electrical, mechanical, and environmental properties
- Build composite cables with a mixture of conductor sizes, insulations, and shielding
- Spec your design fast with the on-line Cable Design Center™
- Receive quotes quickly
- Experience industry-leading turnarounds on custom cables

Manhattan™ Electrical Cable



Manhattan™ Electrical Cable

Signal transmission made reliable



Alpha Wire's Manhattan brand has been a trusted and reliable source of cable for over 60 years. Whether you need something as simple as a power cord or a cable that can maintain audio-video signal integrity in a noisy environment, you'll find the breadth and depth of products to ensure an optimum solution to your application.

- Audio/video
- Computer
- Thermocouple
- Control
- Plenum
- Coaxial
- Cords/cordage
- High temperature
- Security and data
- Instrumentation

Audio/video cable

Choose the correct number of conductors, gauge, insulation, shielding, jacket material, UL/CSA/NEC approvals, and any other parameters to find the right cable for your application.

Computer cable

We offer the widest range of shielded and unshielded configurations to satisfy applications including traditional RS-232 and

RS-422 interfaces, point-of-sale equipment, and modems and multiplexers. For extended distances, we offer cables with very low capacitance.

Instrumentation cable

Maintain the integrity of analog and digital signals with our broad product portfolio of single and multiple pair shielded and unshielded products.

Control cable

We offer UL style TC in a variety of conductor counts, gauges, and shielding options, all with durable PVC/nylon insulation and PVC jackets. We also offer MIL-DTL-16878 cables with 600 V and 1000 V ratings.

Plenum cable

We offer a full range of cables for control, computer interconnections, security, alarms, and building energy management systems in a variety of plenum-rated insulations and jackets.

Coaxial cable

For a complete range of 50, 75, 93, and 100 ohm coaxial, twinaxial, and triaxial cables, we offer a wide range of insulations and jackets meeting the requirements of military specifications and regulatory agencies such as UL and CSA.

Cords/cordsets

All our cords are UL Listed and CSA Certified; we also offer a wide range of CENELEC-approved products for international use. Options include two- and three-conductor cords, shielded or unshielded, stripped and terminated cable ends, straight or retractile cords, and all common plug and receptacle configurations.

High-temperature cable

Alpha Wire's Manhattan brand of high-temperature cables are available for temperatures ranging from 150°C to 540°C. We make it easy for you select the right cable to meet the demanding high-temperature requirements for control and power applications.

Security and data

Count on Alpha Wire for a complete product family of security and data cables, optimized for security video, data, and monitoring applications.

Thermocouple cable

You can find the perfect Manhattan brand thermocouple cable based on conductor combinations JX, KX, EX, and SX, as well as insulations suited for applications up to 200°C, for quality and accurate temperature measurement.

Manhattan™ Audio/Video Cable

300 V Unshielded, Multiconductor, SR-PVC/PVC, PVC

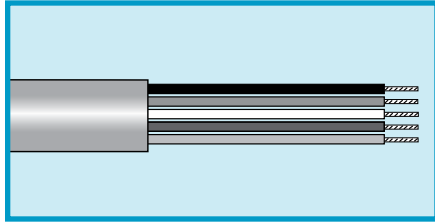

**UL AWM 2464, 2509, 2576,
UL CM, CMG
CSA CM, CMG FT4**

Applications

- Unbalanced intercom and sound systems
- Remote circuit control
- Low-voltage circuits

Operating Temperature

- -20°C to +80°C (AWM)
- -20°C to +75°C (CM, CMG)

Conductor Color Coding

- See tables

Materials

- Stranded tinned copper conductors
- PVC or semirigid PVC insulation
- Slate PVC jacket

Availability

100 ft (30.5 m)
500 ft (152 m)
1000 ft (305 m)
Bulk, cut to length
(Minimums may apply)

UL AWM 2509, UL CMG, PVC Insulation

22 AWG (0.35 mm²)

Stranding: 7/30 (7 x 0.25 mm)
Insulation thickness: 0.016 (0.41 mm)
Color Code J

Part No.	Conductors	Nominal Diameter		Jacket Thickness	
		Inch	mm	Inch	mm
M13302	2	0.174	4.42	0.025	0.64

UL AWM 2576, UL CM, PVC Insulation (150 V)

22 AWG (0.35 mm²)

Stranding: 7/30 (7 x 0.25 mm)
Insulation thickness: 0.010 (0.25 mm)

Part No.	Conductors	Nominal Diameter		Jacket Thickness		Color Code
		Inch	mm	Inch	mm	
M13303	3	0.172	4.37	0.032	0.81	Black, Green, Red
M13304	4	0.185	4.70	0.032	0.81	O
M13305	5	0.200	5.08	0.032	0.81	O
M13306	6	0.215	5.46	0.032	0.81	O
M13307	7	0.215	5.46	0.032	0.81	O
M13308	8	0.230	5.84	0.032	0.81	O
M13309	9	0.246	6.25	0.032	0.81	O
M13310	10	0.264	6.71	0.032	0.81	O
M13312	12	0.272	6.91	0.032	0.81	O
M13315	15	0.310	7.87	0.040	1.02	F
M13320	20	0.342	8.69	0.040	1.02	F
M13325	25	0.380	9.65	0.040	1.02	F
M13330	30	0.401	10.19	0.040	1.02	F
M13340	40	0.445	11.30	0.040	1.02	F
M13350	50	0.498	12.65	0.045	1.14	F

UL AWM 2464, UL CM, PVC Insulation

20 AWG (0.56 mm²)

Stranding: 7/28 (7 x 0.32 mm)
Insulation thickness: 0.013 (0.33 mm)

Part No.	Conductors	Nominal Diameter		Jacket Thickness		Color Code
		Inch	mm	Inch	mm	
M13404	4	0.219	5.56	0.032	0.81	O
M13405	5	0.238	6.05	0.032	0.81	O
M13407	7	0.257	6.53	0.032	0.81	O
M13409	9	0.303	7.70	0.035	0.89	O
M13412	12	0.336	8.53	0.035	0.89	O
M13415	15	0.374	9.50	0.040	1.02	F

UL AWM 2509, UL CMG, PVC Insulation

20 AWG (0.56 mm²)

Stranding: 7/28 (7 x 0.32 mm)
Insulation thickness: 0.016 (0.41 mm)
Color Code J

Part No.	Conductors	Nominal Diameter		Jacket Thickness	
		Inch	mm	Inch	mm
M13402	2	0.180	4.57	0.020	0.51



Manhattan™ Audio/Video Cable

300 V Unshielded, Multiconductor, SR-PVC, PVC

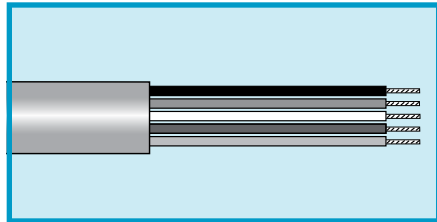

**UL AWM 2463, 2464, 2509,
2576, 2598**
UL CM, CMG
UL CL2, CL3
CSA CM, CMG FT4

Applications

- Unbalanced intercom and sound systems
- Remote circuit control
- Low-voltage circuits

Operating Temperature

- -20°C to +80°C (AWM)
- -20°C to +75°C (CM, CMG, CL2, CL3)

Conductor Color Coding

- See tables

Materials

- Stranded tinned copper conductors
- PVC or semirigid PVC insulation
- Slate PVC jacket

Availability

100 ft (30.5 m)
500 ft (152 m)
1000 ft (305 m)
Bulk, cut to length
(Minimums may apply)

UL AWM 2509, UL CMG, PVC Insulation

18 AWG (0.81 mm²)

Stranding: 16/30 (16 x 0.25 mm)
Insulation thickness: 0.016 (0.41 mm)
Color Code J

Part No.	Conductors	Nominal Diameter		Jacket Thickness	
		Inch	mm	Inch	mm
M13502	2	0.198	5.03	0.020	0.51

UL AWM 2598, UL CM, PVC Insulation

18 AWG (0.96 mm²)

Stranding: 19/30 (19 x 0.25 mm)
Insulation thickness: 0.018 (0.46 mm)

Part No.	Conductors	Nominal Diameter		Jacket Thickness		Color Code
		Inch	mm	Inch	mm	
M13503	3	0.249	6.32	0.032	0.81	O
M13504	4	0.272	6.91	0.032	0.81	O
M13505	5	0.297	7.54	0.032	0.81	O
M13507	7	0.333	8.46	0.037	0.94	O
M13509	9	0.387	9.83	0.037	0.94	O
M13512	12	0.437	11.10	0.040	1.02	F
M13515	15	0.485	12.32	0.045	1.14	F
M13519	19	0.520	13.21	0.045	1.14	F
M13525	25	0.636	16.15	0.060	1.52	F

UL AWM 2576, UL CM, PVC Insulation

16 AWG (1.32 mm²)

Stranding: 19/0.0117 (19 x 0.30 mm)
Color Code F

Part No.	Conductors	Nominal Diameter		Jacket Thickness		Insulation Thickness	
		Inch	mm	Inch	mm	Inch	mm
M13572	2	0.274	6.96	0.032	0.81	0.023	0.58
M13574	4	0.378	9.60	0.045	1.14	0.030	0.76

UL AWM 2463, UL CL2 or CL3, PVC Insulation

14 AWG (2.08 mm²)

Stranding: 19/0.0147 (19 x 0.37 mm)
Insulation thickness: 0.032 (0.81 mm)
Color Code F

Part No.	Conductors	Nominal Diameter		Jacket Thickness		Approval
		Inch	mm	Inch	mm	
M13582	2	0.346	8.79	0.035	0.89	CL2
M13584	4	0.404	10.26	0.035	0.89	CL3

UL AWM 2463, UL CL3, PVC Insulation

12 AWG (3.29 mm²)

Stranding: 19/0.0185 (19 x 0.47 mm)
Insulation thickness: 0.032 (0.81 mm)
Color Code F

Part No.	Conductors	Nominal Diameter		Jacket Thickness	
		Inch	mm	Inch	mm
M13590	2	0.394	10.00	0.040	1.02



Manhattan™ Audio/Video Cable

300 V Unshielded, Multiconductor, PVC, PVC

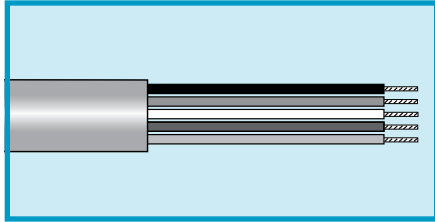

UL AWM 2463 (600 V) VW-1

Applications

- Unbalanced intercom and sound systems
- Remote circuit control
- Low-voltage circuits

Operating Temperature

- -20°C to +80°C

Conductor Color Coding

- Chart F (page 532)

Materials

- Stranded tinned copper conductors
- PVC insulation
- Slate PVC jacket

Availability

100 ft (30.5 m)

500 ft (152 m)

1000 ft (305 m)

Bulk, cut to length

(Minimums may apply)

16 AWG (1.32 mm ²)					
Stranding: 19/0.0117 (19 x 0.30 mm)					
Insulation thickness: 0.032 (0.81 mm)					
Part No.	Conductors	Nominal Diameter		Jacket Thickness	
		Inch	mm	Inch	mm
M3704	4	0.392	9.96	0.047	1.19
M3705	5	0.428	10.87	0.047	1.19
M3707	7	0.465	11.81	0.047	1.19
M3709	9	0.574	14.58	0.063	1.60
M3712	12	0.637	16.17	0.063	1.60
M3715	15	0.691	17.55	0.063	1.60
M3719	19	0.742	18.85	0.063	1.60
M3725	25	0.904	22.96	0.083	2.11



Manhattan™ Audio/Video Cable

300 V Braid Shield, Multiconductor, PE, PVC

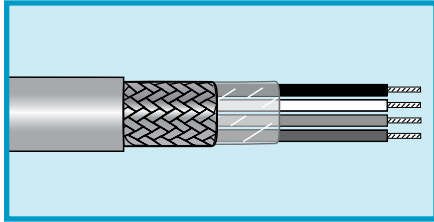

UL AWM 2092, 2093, 2094
UL CM

Applications

- Sensing, recording, monitoring devices, and telemetry

Operating Temperature

- -20°C to +75°C (CM)
- -20°C to +60°C (AWM)

Conductor Color Coding

- Chart H (page 533)

Materials

- Stranded tinned copper conductors
- Polyethylene insulation
- Tinned copper braid shield, 90% coverage
- Slate PVC jacket

Availability

100 ft (30.5 m)
500 ft (152 m)
1000 ft (305 m)
Bulk, cut to length
(Minimums may apply)

24 AWG (0.20 mm²)

Stranding: 10/34 (10 x 0.16 mm)
Insulation thickness: 0.016 (0.41 mm)

Part No.	Conductors	Nominal Diameter		Jacket Thickness		UL AWM
		Inch	mm	Inch	mm	
M1102	2	0.177	4.50	0.020	0.51	2092
M1103	3	0.186	4.72	0.020	0.51	2093
M1104	4	0.200	5.08	0.020	0.51	2094
M1105	5	0.217	5.51	0.020	0.51	2094
M1106	6	0.234	5.94	0.020	0.51	2094

22 AWG (0.38 mm²)

Stranding: 19/34 (19 x 0.16 mm)
Insulation thickness: 0.016 (0.41 mm)

Part No.	Conductors	Nominal Diameter		Jacket Thickness		UL AWM
		Inch	mm	Inch	mm	
M1112	2	0.193	4.90	0.020	0.51	2092
M1113	3	0.203	5.16	0.020	0.51	2093
M1114	4	0.220	5.59	0.020	0.51	2094
M1115	5	0.239	6.07	0.020	0.51	2094
M1116	6	0.258	6.55	0.020	0.51	2094
M1118	8	0.278	7.06	0.020	0.51	2094

20 AWG (0.52 mm²)

Stranding: 26/34 (26 x 0.16 mm)
Insulation thickness: 0.016 (0.41 mm)

Part No.	Conductors	Nominal Diameter		Jacket Thickness		UL AWM
		Inch	mm	Inch	mm	
M1122	2	0.229	5.82	0.032	0.81	2092
M1123	3	0.246	6.25	0.035	0.89	2093
M1124	4	0.264	6.71	0.035	0.89	2094
M1125	5	0.285	7.24	0.035	0.89	2094
M1126	6	0.306	7.77	0.035	0.89	2094
M1128	8	0.328	8.33	0.035	0.89	2094
M1130	10	0.375	9.53	0.035	0.89	2094
M1132	12	0.386	9.80	0.035	0.89	2094
M1135	15	0.417	10.59	0.035	0.89	2094
M1140	20	0.464	11.79	0.035	0.89	2094



Manhattan™ Audio/Video Cable

300 V Braid Shield, Multiconductor, PE, PVC

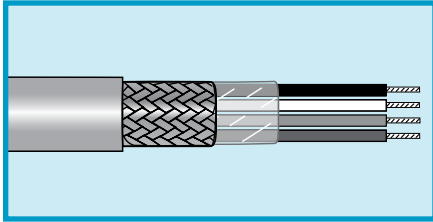

**UL AWM 2092, 2093, 2094
UL CM**

Applications

- Sensing, recording, monitoring devices, and telemetry

Operating Temperature

- -20°C to +75°C (CM)
- -20°C to +60°C (AWM)

Conductor Color Coding

- Chart H (page 533)

Materials

- Stranded tinned copper conductors
- Polyethylene insulation
- Tinned copper braid shield, 90% coverage
- Slate PVC jacket

Availability

100 ft (30.5 m)
500 ft (152 m)
1000 ft (305 m)
Bulk, cut to length
(Minimums may apply)

18 AWG (0.82 mm²)

Stranding: 41/34 (41 x 0.16 mm)
Insulation thickness: 0.016 (0.41 mm)

Part No.	Conductors	Nominal Diameter		Jacket Thickness		UL AWM
		Inch	mm	Inch	mm	
M1142	2	0.253	6.43	0.035	0.89	2092
M1143	3	0.265	6.73	0.035	0.89	2093
M1144	4	0.286	7.26	0.035	0.89	2094
M1146	6	0.333	8.46	0.035	0.89	2094

16 AWG (1.31 mm²)

Stranding: 65/34 (65 x 0.16 mm)
Insulation thickness: 0.016 (0.41 mm)

Part No.	Conductors	Nominal Diameter		Jacket Thickness		UL AWM
		Inch	mm	Inch	mm	
M1162	2	0.277	7.04	0.035	0.89	2092
M1163	3	0.291	7.39	0.035	0.89	2093
M1164	4	0.308	7.82	0.035	0.89	2094



Manhattan™ Audio/Video Cable

300 V Foil Shield, Overall, Multiconductor, PP, HDPE
Direct Burial

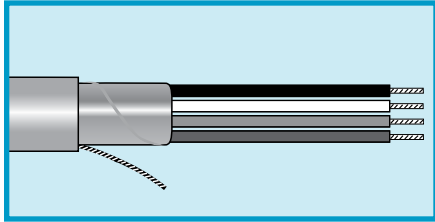

**UL AWM 2092, 2093, 2094
UL CM**

Applications

- Direct burial audio and data transmission

Operating Temperature

- -20°C to +80°C

Conductor Color Coding

- See table

Materials

- Solid tinned copper conductors
- Polypropylene insulation
- Aluminum/polyester foil shield, 25% overlap min.
Foil facing inward
- 22 AWG (0.32 mm²) solid tinned copper drain wire
- Black high-density polyethylene jacket

Features

- Direct Burial

Availability

100 ft (30.5 m)

500 ft (152 m)

1000 ft (305 m)

Bulk

(Minimums may apply)

20 AWG (0.51 mm²)

Stranding: : 10/30 (10 x 0.25 mm)
Insulation thickness: 0.013 (0.33 mm)

Part No.	Conductors	Nominal Diameter		Jacket Thickness		Color Code
		Inch	mm	Inch	mm	
M39047	2	0.193	4.90	0.035	0.89	O
M39048	3	0.202	5.13	0.035	0.89	O
M39049	10	0.319	8.10	0.040	1.02	O
M39050	15	0.363	9.22	0.045	1.14	F

Mutual capacitance: 22.2 pF/ft (72.8 pF/m)
Ground capacitance: 40 pF/ft (131.2 pF/m)
Except Part No. M39047:
Mutual capacitance: 24.5 pF/ft (80.3 pF/m)
Ground capacitance: 44 pF/ft (144.3 pF/m)



Manhattan™ Audio/Video Cable

350 V Individually Foil Shielded Pairs, Multipair, PP, HDPE
Direct Burial

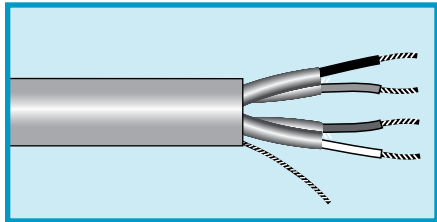

20 AWG (0.51 mm²)

Stranding: 10/30 (10 x 0.25)
Insulation thickness: 0.013 (0.33 mm)

Part No.	Pairs	Nominal Diameter		Jacket Thickness	
		Inch	mm	Inch	mm
M39051	3	0.336	8.53	0.040	1.02
M39052	6	0.446	11.33	0.045	1.14

Mutual capacitance: 24.5 pF/ft (80.3 pF/m)
Ground capacitance: 44 pF/ft (144.3 pF/m)

UL AWM 2092, 2093, 2094
UL CM

Applications

- Direct burial audio and data transmission

Operating Temperature

- -20°C to +80°C

Conductor Color Coding

- Chart K (page 529)

Materials

- Stranded tinned copper conductors
- Polypropylene insulation
- Aluminum/polyester foil shield, 25% overlap min.
Foil facing inward
- 22 AWG (0.35 mm²) stranded tinned copper drain wire
- Black high-density polyethylene jacket

Availability

100 ft (30.5 m)
500 ft (152 m)
1000 ft (305 m)
Bulk, cut to length
(Minimums may apply)



Manhattan™ Audio/Video Cable

300 V Unshielded, Multipair, PVC, PVC

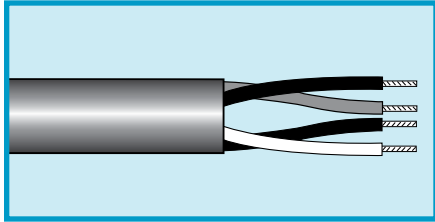

UL AWM 2464, 2576 (150 V)
UL CMG
CSA CMG FT4 (150 V)

Applications

- Speakers and sound systems

Operating Temperature

- -20°C to +80°C (AWM)
- -20°C to +75°C (CMG)

Conductor Color Coding

- Chart K (page 529)

Materials

- Solid or stranded tinned copper conductors
- PVC insulation
- Slate PVC jacket

Availability

100 ft (30.5 m)
 500 ft (152 m)
 1000 ft (305 m)
 Bulk, cut to length
 (Minimums may apply)

AWM 2576, CMG

22 AWG (0.32 mm²)

Stranding: Solid
 Insulation thickness: 0.010 (0.25 mm)

Part No.	Pairs	Nominal Diameter		Jacket Thickness	
		Inch	mm	Inch	mm
M13001	1	0.157	3.98	0.032	0.81
M13002	2	0.215	5.46	0.032	0.81
M13003	3	0.226	5.74	0.032	0.81
M13004	4	0.246	6.24	0.032	0.81
M13005	5	0.267	6.78	0.032	0.81
M13006	6	0.289	7.34	0.032	0.81
M13008	8	0.318	8.07	0.035	0.89
M13009	9	0.342	8.68	0.035	0.89
M13013	13	0.392	9.95	0.037	0.94
M13019	19	0.452	11.48	0.040	1.02
M13027	27	0.547	13.89	0.045	1.14

AWM 2576, CMG

22 AWG (0.35 mm²)

Stranding: 7/30 (7 x 0.25 mm)
 Insulation thickness: 0.010 (0.25 mm)

Part No.	Pairs	Nominal Diameter		Jacket Thickness	
		Inch	mm	Inch	mm
M13032	2	0.231	5.86	0.032	0.81
M13033	3	0.244	6.19	0.032	0.81
M13034	4	0.265	6.73	0.032	0.81
M13036	6	0.320	8.13	0.035	0.89
M13039	9	0.375	9.52	0.037	0.94
M13042	12	0.424	10.76	0.040	1.02
M13045	15	0.460	11.68	0.040	1.02
M13049	19	0.493	12.52	0.040	1.02
M13057	27	0.598	15.18	0.045	1.14



Manhattan™ Audio/Video Cable

300 V Unshielded, Multipair, PVC, PVC

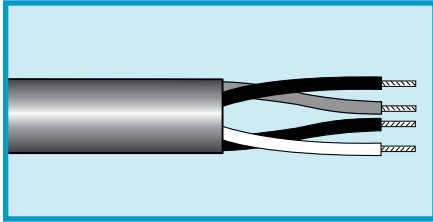

UL AWM 2464, 2576 (150 V)
UL CMG
CSA CMG FT4 (150 V)

Applications

- Speakers and sound systems

Operating Temperature

- -20°C to +80°C (AWM)
- -20°C to +75°C (CMG)

Conductor Color Coding

- Chart K (page 529)

Materials

- Solid or stranded tinned copper conductors
- PVC insulation
- Slate PVC jacket

Availability

100 ft (30.5 m)
 500 ft (152 m)
 1000 ft (305 m)
 Bulk, cut to length
 (Minimums may apply)

AWM 2464, CMG

20 AWG (0.56 mm²)

Stranding: 7/28 (7 x 0.32 mm)
 Insulation thickness: 0.016 (0.41 mm)

Part No.	Pairs	Nominal Diameter		Jacket Thickness	
		Inch	mm	Inch	mm
M13063	3	0.224	5.68	0.035	0.89
M13066	6	0.284	7.21	0.035	0.89
M13069	9	0.328	8.33	0.035	0.89
M13072	15	0.405	10.28	0.040	1.02

AWM 2464, CMG

18 AWG (0.81 mm²)

Stranding: 16/30 (16 x 0.25 mm)
 Insulation thickness: 0.016 (0.41 mm)

Part No.	Pairs	Nominal Diameter		Jacket Thickness	
		Inch	mm	Inch	mm
M13081	1	0.225	5.72	0.032	0.81
M13082	2	0.326	8.28	0.032	0.81
M13083	3	0.346	8.79	0.032	0.81
M13084	4	0.380	9.65	0.032	0.81
M13085	5	0.418	10.62	0.032	0.81
M13086	6	0.458	11.63	0.032	0.81
M13088	8	0.508	12.90	0.037	0.94
M13089	9	0.554	14.07	0.040	1.02
M13092	12	0.633	16.08	0.046	1.17
M13095	15	0.700	17.78	0.051	1.30
M13099	19	0.761	19.33	0.055	1.40



Manhattan™ Audio/Video Cable

300 V Foil Shield, Overall, Multiconductor, PE, PVC

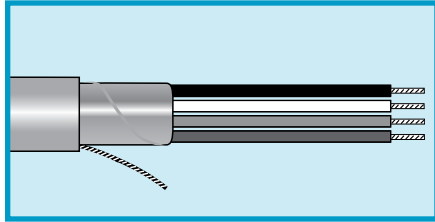

UL AWM 2092, 2093, 2094
UL CMG
CSA CMG
CSA FT4

Applications

- Audio and sound systems requiring small-diameter cable with 100% shield coverage

Operating Temperature

- -20°C to +75°C (CMG)
- -20°C to +60°C (AWM)

Conductor Color Coding

- AWM 2092: 1 Black, 2 Red (except Part No. M3222: Black, Natural)
- AWM 2093: 1 Black, 2 Red, 3 Natural
- AWM 2094: 1 Black, 2 Red, 3 Natural, 4 Green

Materials

- Stranded tinned copper conductors
- Polyethylene insulation
- Aluminum/polyester foil shield, 25% overlap min. Foil facing inward
- Stranded tinned copper drain wire (see tables for size)
- Slate PVC jacket

Availability

100 ft (30.5 m)
 500 ft (152 m)
 1000 ft (305 m)
 Bulk, cut to length
 (Minimums may apply)



24 AWG (0.22 mm²)

Stranding: 7/32 (7 x 0.20 mm)
 Insulation thickness: 0.016 (0.41 mm)
 24 AWG (0.22 mm²) drain wire

Part No.	Conductors	Nominal Diameter		Jacket Thickness		UL AWM
		Inch	mm	Inch	mm	
M3222	2	0.159	4.04	0.020	0.51	2092
M3223	3	0.168	4.27	0.020	0.51	2093
M3224	4	0.182	4.62	0.020	0.51	2094

22 AWG (0.35 mm²)

Stranding: 7/30 (7 x 0.25 mm)
 Insulation thickness: 0.016 (0.41 mm)
 22 AWG (0.35 mm²) drain wire

Part No.	Conductors	Nominal Diameter		Jacket Thickness		UL AWM
		Inch	mm	Inch	mm	
M3226	2	0.171	4.34	0.020	0.51	2092
M3227	3	0.181	4.60	0.020	0.51	2093
M3228	4	0.197	5.00	0.020	0.51	2094

20 AWG (0.56 mm²)

Stranding: 7/28 (7 x 0.32 mm)
 Insulation thickness: 0.016 (0.41 mm)
 20 AWG (0.56 mm²) drain wire

Part No.	Conductors	Nominal Diameter		Jacket Thickness		UL AWM
		Inch	mm	Inch	mm	
M3232	2	0.187	4.75	0.020	0.51	2092
M3233	3	0.198	5.03	0.020	0.51	2093
M3234	4	0.216	5.49	0.020	0.51	2094

18 AWG (0.81 mm²)

Stranding: 16/30 (16 x 0.25 mm)
 Insulation thickness: 0.016 (0.41 mm)
 20 AWG (0.56 mm²) drain wire

Part No.	Conductors	Nominal Diameter		Jacket Thickness		UL AWM
		Inch	mm	Inch	mm	
M3242	2	0.205	5.21	0.020	0.51	2092
M3243	3	0.217	5.51	0.020	0.51	2093
M3244	4	0.238	6.05	0.020	0.51	2094

Manhattan™ Audio/Video Cable

300 V Foil Shield, Overall, Multiconductor, PE, PVC

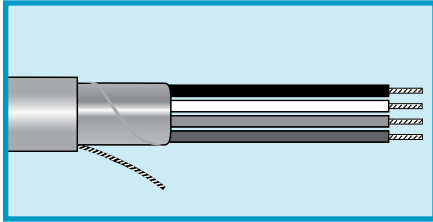

UL AWM 2092, 2093, 2094
UL CMG
UL CL2 (150 V)
CSA CMG
CSA FT4

Applications

- Audio and sound systems requiring small-diameter cable with 100% shield coverage

Operating Temperature

- -20°C to +75°C (CMG)
- -20°C to +60°C (AWM)

Conductor Color Coding

- AWM 2092 and CL2: 1 Black, 2 Red
- AWM 2093: 1 Black, 2 Red, 3 Natural

Materials

- Stranded tinned copper conductors
- Polyethylene insulation
- Aluminum/polyester foil shield, 25% overlap min. Foil facing inward
- Stranded tinned copper drain wire (see tables for size)
- Slate PVC jacket

Availability

100 ft (30.5 m)
 500 ft (152 m)
 1000 ft (305 m)
 Bulk, cut to length
 (Minimums may apply)

16 AWG (1.32 mm ²)						
Stranding: 19/0.0117 (19 x 0.30 mm) Insulation thickness: 0.016 (0.41 mm) 18 AWG (0.81 mm ²) drain wire						
Part No.	Conductors	Nominal Diameter		Jacket Thickness		UL AWM
		Inch	mm	Inch	mm	
M3247	2	0.229	5.82	0.020	0.51	2092
M3248	3	0.243	6.17	0.020	0.51	2093

14 AWG (2.08 mm ²)						
Stranding: 41/30 (41 x 0.25 mm) Insulation thickness: 0.020 (0.51 mm) 16 AWG (1.32 mm ²) drain wire						
Part No.	Conductors	Nominal Diameter		Jacket Thickness		UL Style
		Inch	mm	Inch	mm	
M3249	2	0.288	7.32	0.030	0.76	CL2

12 AWG (3.29 mm ²)						
Stranding: 65/30 (65 x 0.25 mm) Insulation thickness: 0.020 (0.51 mm) 14 AWG (2.08 mm ²) drain wire						
Part No.	Conductors	Nominal Diameter		Jacket Thickness		UL Style
		Inch	mm	Inch	mm	
M3250	2	0.326	8.28	0.030	0.76	CL2



Manhattan™ Audio/Video Cable

300 V Individually Foil Shielded Pairs, Multipair, PP/PE/SR-PVC, PVC

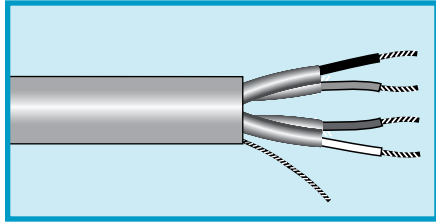

**UL AWM 2464, 2493, 2919
(30 V)**

**UL CM
CSA CM**

Applications

- Audio and sound systems

Operating Temperature

- -20°C to +80°C (AWM 2464)
- -20°C to +75°C (CM)
- -20°C to +60°C (AWM 2919, 2493)

Conductor Color Coding

- AWM 2919: Chart K (page 529)
- AWM 2493: Chart A (page 528)
- AWM 2464 and CM: Black/Red, Green/White

Materials

- Solid or stranded tinned copper conductors
- Aluminum/polyester foil shield, 25% overlap min.
Foil facing inward
Stranded tinned copper drain wire equal in size to conductor (unless noted)
- Polyethylene, polypropylene, or semirigid PVC insulation (see tables)
- Slate PVC jacket

Availability

100 ft (30.5 m)
500 ft (152 m)
1000 ft (305 m)
Bulk, cut to length
(Minimums may apply)

AWM 2493, UL CM, Polypropylene Insulation

22 AWG (0.32 mm²)

Stranding: Solid
Insulation thickness: 0.010 (0.25 mm)

Part No.	Pairs	Nominal Diameter		Jacket Thickness	
		Inch	mm	Inch	mm
M39039	6	0.362	9.19	0.050	1.27
M39040	9	0.415	10.54	0.050	1.27
M39041	11	0.459	11.66	0.050	1.27
M39042	15	0.507	12.88	0.050	1.27

UL CM, Polypropylene Insulation

22 AWG (0.35 mm²)

Stranding: 7/30 (7 x 0.25 mm)
Insulation thickness: 0.008 (0.20 mm)

Part No.	Pairs	Nominal Diameter		Jacket Thickness	
		Inch	mm	Inch	mm
M4473	2	0.150	3.81	0.19	0.48

AWM 2919, UL CM, Polypropylene Insulation

22 AWG (0.35 mm²)

Stranding: 7/30 (7 x 0.25 mm)
Insulation thickness: 0.010 (0.25 mm)

Part No.	Pairs	Nominal Diameter		Jacket Thickness	
		Inch	mm	Inch	mm
M13103	3	0.271	6.88	0.032	0.81
M13106	6	0.349	8.86	0.032	0.81
M13109	9	0.412	10.46	0.032	0.81
M13111	11	0.466	11.84	0.035	0.89
M13112	12	0.466	11.84	0.035	0.89
M13115	15	0.537	13.64	0.050	1.27
M13117	17	0.577	14.66	0.050	1.27
M13119	19	0.577	14.66	0.050	1.27
M13127	27	0.685	17.40	0.050	1.27
M13130	37	0.766	19.46	0.050	1.27

AWM 2464, UL CM, SR-PVC Insulation

20 AWG (0.56 mm²)

Stranding: 7/28 (7 x 0.32 mm)
Insulation thickness: 0.010 (0.25 mm)

Part No.	Pairs	Nominal Diameter		Jacket Thickness	
		Inch	mm	Inch	mm
M13142	2	0.284	7.21	0.032	0.81



Manhattan™ Audio/Video Cable

300 V Individually Foil Shielded Pairs, Multipair, PP/PE/SR-PVC, PVC

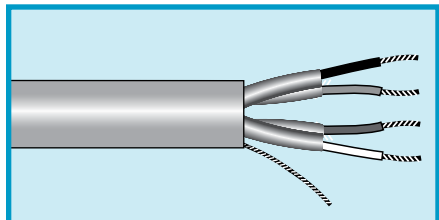

**UL AWM 2464, 2493, 2919
(30 V)
UL CM
CSA CM**

Applications

- Audio and sound systems

Operating Temperature

- -20°C to +80°C (AWM 2464)
- -20°C to +75°C (CM)
- -20°C to +60°C (AWM 2919, 2493)

Conductor Color Coding

- AWM 2919: Chart K (page 529)
- AWM 2493: Chart A (page 528)
- AWM 2464 and CM: Black/Red, Green/White

Materials

- Solid or stranded tinned copper conductors
- Aluminum/polyester foil shield, 25% overlap min.
Foil facing inward
Stranded tinned copper drain wire equal in size to conductor (unless noted)
- Polyethylene, polypropylene, or semirigid PVC insulation (see tables)
- Slate PVC jacket

Availability

100 ft (30.5 m)
500 ft (152 m)
1000 ft (305 m)
Bulk, cut to length
(Minimums may apply)

AWM 2919, UL CM, Polyethylene Insulation

20 AWG (0.56 mm²)

Stranding: 7/28 (7 x 0.32 mm)
Insulation thickness: 0.013 (0.25 mm)

Part No.	Pairs	Nominal Diameter		Jacket Thickness	
		Inch	mm	Inch	mm
M13143	3	0.324	8.23	0.032	0.64
M13146	6	0.448	11.38	0.043	1.09
M13149	9	0.522	13.26	0.043	1.09
M13151	11	0.579	14.71	0.050	1.27
M13152	12	0.598	15.19	0.050	1.27
M13155	15	0.650	16.51	0.050	1.27

AWM 2919, UL CM, Polyethylene Insulation

18 AWG (0.81 mm²)

Stranding: 16/30 (16 x 0.25 mm)
Insulation thickness: 0.016 (0.41 mm)
Drain wire: 20 AWG (0.56 mm²)

Part No.	Pairs	Nominal Diameter		Jacket Thickness	
		Inch	mm	Inch	mm
M13173	3	0.380	9.65	0.032	0.81
M13176	6	0.541	13.74	0.050	1.27
M13179	9	0.632	16.05	0.050	1.27
M13182	12	0.737	18.72	0.065	1.65
M13185	15	0.817	20.75	0.065	1.65



Manhattan™ Audio/Video Cable

300 V Individually Foil Shielded Pairs, Multipair, PP, PVC

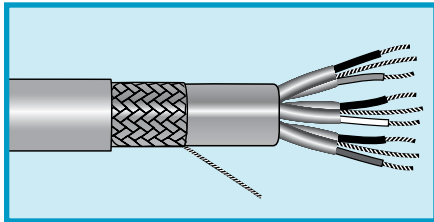

20 AWG (0.56 mm ²)					
Stranding: 7/28 (7 x 0.32 mm)					
Insulation thickness: 0.015 (0.38 mm)					
Part No.	Pairs	Nominal Diameter		Jacket Thickness	
		Inch	mm	Inch	mm
M14604	4	0.365	9.27	0.030	0.76

Mutual capacitance: 23 pF/ft (75.5 pF/m)
Ground capacitance: 41 pF/ft (134.5 pF/m)

UL CMG VW-1
CSA CMG

Applications

- Communication and instrumentation systems requiring special wiring
- Audio process-control computer systems

Operating Temperature

- -20°C to +105°C

Conductor Color Coding

- 1 Black-Red, 2 Green-White, 3 White/Red-White/Black, 4 White/Yellow-White/Green

Materials

- Stranded tinned copper conductors
- Polypropylene insulation
- Aluminum/polyester foil shield, 25% overlap min
Foil facing inward
- 22 AWG (0.35 mm²) stranded tinned copper drain wire
- Slate PVC jacket

Availability

100 ft (30.5 m)
500 ft (152 m)
1000 ft (305 m)
Bulk, cut to length
(Minimums may apply)



Manhattan™ Audio/Video Cable

Braid or Spiral Shield, Single Conductor, PE, PVC
Microphone Cable

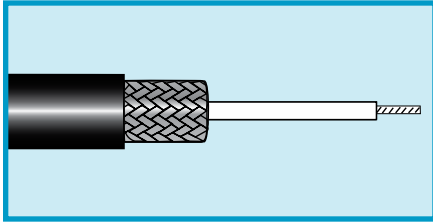

Applications

- High-impedance microphones
- Hi-fi interconnection systems
- Instruments and tape recorders

Operating Temperature

- -20°C to +60°C

Materials

- Stranded tinned copper conductors*
- Polyethylene insulation

- Braided tinned copper or spiral wrapped tinned copper shield
- Slate PVC jacket

Availability

100 ft (30.5 m)
500 ft (152 m)
1000 ft (305 m)
Bulk, cut to length
(Minimums may apply)

Part No.	Voltage	Wire Size		Stranding		Nominal Diameter		Shield	Jacket Thickness		Insulation Thickness		Capacitance	
		AWG	mm ²	AWG	mm	Inch	mm		Inch	mm	Inch	mm	pF/ft	pF/m
M3601*	300	30	0.05	7/38*	7 x 0.10	0.086	2.18	Braid	0.016	0.41	0.012	0.30	32	105.0
M3633*	1000	26	0.14	7/34*	7 x 0.16	0.101	2.57	Spiral	0.020	0.50	0.016	0.41	35	114.8
M3605	3500	24	0.20	10/34	10 x 0.16	0.146	3.71	Braid	0.030	0.76	0.020	0.50	36	118.1
M3635	1000	24	0.20	10/34	10 x 0.16	0.106	2.69	Spiral	0.020	0.50	0.016	0.41	41	134.5
M3611	4000	20	0.52	26/34	26 x 0.16	0.180	4.57	Braid	0.030	0.76	0.030	0.76	39	128.0

*M3601 and M3633 have 3 strands of tinned copper and 4 strands of tinned Copperweld.

Manhattan™ Audio/Video Cable

300 V Braid Shield, Multiconductor, PVC, PVC
Microphone Cable

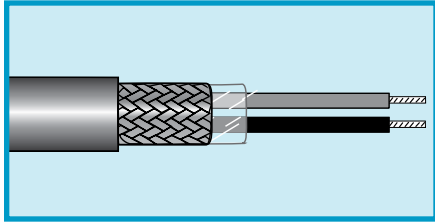

UL AWM 2095
UL CMG
CSA CMG FT4

Operating Temperature

- -20°C to +80°C (AWM)
- -20°C to +75°C (CMG)

Conductor Color Code

- 1 Black, 2 Red

Materials

- Solid or stranded tinned copper conductors
- PVC insulation
- Tinned copper braid shield, 88% coverage
Drain wire equivalent to conductors
- Black PVC jacket

Availability

100 ft (30.5 m)
500 ft (152 m)
1000 ft (305 m)
Bulk, cut to length
(Minimums may apply)

22 AWG (0.32 mm²)

Stranding: Solid
Insulation thickness: 0.016 (0.41 mm)

Part No.	Conductors	Nominal Diameter		Jacket Thickness	
		Inch	mm	Inch	mm
M14461	2	0.195	4.95	0.028	0.71

Mutual capacitance: 41 pF/ft (134.5 pF/m)
Ground capacitance: 74 pF/ft (242.8 pF/m)

22 AWG (0.35 mm²)

Stranding: 7/30 (7 x 0.25 mm)
Insulation thickness: 0.016 (0.41 mm)

Part No.	Conductors	Nominal Diameter		Jacket Thickness	
		Inch	mm	Inch	mm
M14462	2	0.205	5.21	0.028	0.71

Mutual capacitance: 43 pF/ft (141.3 pF/m)
Ground capacitance: 77 pF/ft (252.6 pF/m)

Manhattan™ Audio/Video Cable

300 V Unshielded, Multiconductor, PVC, PVC

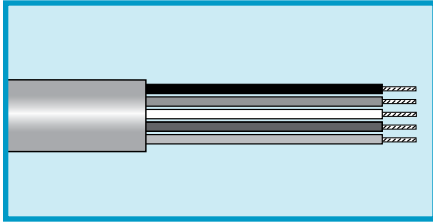

UL AWM 2509, 2576
UL CL2
UL CMG
CSA CMG FT4

Applications

- Unbalanced intercom and sound systems
- Remote circuit controls
- Telephones
- Low-voltage circuits

Operating Temperature

- -20°C to +80°C (AWM)
- -20°C to +75°C (CMG and CL2)

Conductor Color Coding

- Chart D (page 531)

Materials

- Stranded tinned copper conductors
- PVC insulation
- Slate PVC jacket

Availability

100 ft (30.5 m)
 500 ft (152 m)
 1000 ft (305 m)
 Bulk, cut to length
 (Minimums may apply)

UL AWM 2509, UL CMG

20 AWG (0.56 mm²)

Stranding: 7/28 (7 x 0.32 mm)
 Insulation thickness: 0.016 (0.41 mm)
 Color Code D

Part No.	Conductors	Nominal Diameter		Jacket Thickness	
		Inch	mm	Inch	mm
M33402	2	0.183	4.65	0.020	0.51
M33403	3	0.191	4.85	0.020	0.51
M33404	4	0.209	5.31	0.020	0.51
M33406	6	0.251	6.38	0.020	0.51
M33408	8	0.273	6.93	0.020	0.51
M33410	10	0.320	8.13	0.020	0.51
M33412	12	0.331	8.41	0.020	0.51
M33415	15	0.362	9.19	0.020	0.51
M33419	19	0.390	9.91	0.020	0.51

UL AWM 2509, UL CMG

18 AWG (0.81 mm²)

Stranding: 16/30 (7 x 0.25 mm)
 Insulation thickness: 0.016 (0.41 mm)
 Color Code D

Part No.	Conductors	Nominal Diameter		Jacket Thickness	
		Inch	mm	Inch	Mm
M33502	2	0.208	5.28	0.025	0.64
M33503	3	0.220	5.59	0.025	0.64
M33504	4	0.241	6.12	0.025	0.64
M33505	5	0.264	6.71	0.025	0.64
M33506	6	0.288	7.32	0.025	0.64
M33507	7	0.288	7.32	0.025	0.64
M33508	8	0.313	7.95	0.025	0.64
M33510	10	0.366	9.30	0.025	0.64
M33512	12	0.378	9.60	0.025	0.64
M33515	15	0.423	10.74	0.030	0.76
M33519	19	0.465	11.81	0.035	0.89
M33525	25	0.544	13.82	0.035	0.89



Manhattan™ Audio/Video Cable

300 V Unshielded, Multiconductor, PVC, PVC

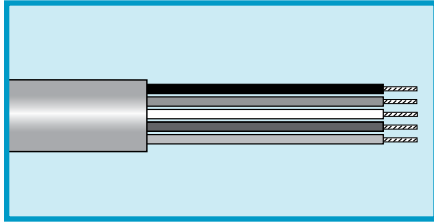

UL AWM 2509, 2576
UL CL2
UL CMG
CSA CMG FT4

Applications

- Unbalanced intercom and sound systems
- Remote circuit controls
- Telephones
- Low-voltage circuits

Operating Temperature

- -20°C to +80°C (AWM)
- -20°C to +75°C (CMG and CL2)

Conductor Color Coding

- Chart D (page 531)

Materials

- Stranded tinned copper conductors
- PVC insulation
- Slate PVC jacket

Availability

100 ft (30.5 m)
 500 ft (152 m)
 1000 ft (305 m)
 Bulk, cut to length
 (Minimums may apply)

UL AWM 2509, UL CMG

16 AWG (1.32 mm²)

Stranding: 19/0.0117 (19 x 0.30 mm)
 Insulation thickness: 0.016 (0.41 mm)
 Color Code D

Part No.	Conductors	Nominal Diameter		Jacket Thickness	
		Inch	mm	Inch	mm
M33572	2	0.232	5.89	0.025	0.64
M33573	3	0.246	6.25	0.025	0.64
M33574	4	0.273	6.93	0.025	0.64
M33576	6	0.327	8.31	0.025	0.64
M33578	8	0.356	9.04	0.025	0.64

UL AWM 2576, UL CL2

14 AWG (2.08 mm²)

Stranding: 41/30 (41 x 0.25 mm)
 Insulation thickness: 0.020 (0.51 mm)

Part No.	Conductors	Nominal Diameter		Jacket Thickness	
		Inch	mm	Inch	mm
M33582	2	0.295	7.49	0.032	0.81
M33583	3	0.313	7.95	0.032	0.81

UL AWM 2576, UL CL2

12 AWG (3.29 mm²)

Stranding: 65/30 (65 x 0.25 mm)
 Insulation thickness: 0.020 (0.51 mm)

Part No.	Conductors	Nominal Diameter		Jacket Thickness	
		Inch	mm	Inch	mm
M33590	2	0.333	8.45	0.032	0.81
M33591	3	0.354	8.99	0.032	0.81



Manhattan™ Audio/Video Cable

300 V Unshielded, Multiconductor, SR-PVC, PVC

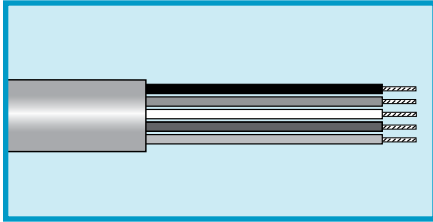

**UL AWM 2464, 2509, 2576
UL CMG
CSA CMG FT4**

Applications

- Unbalanced intercom and sound systems
- Remote circuit controls
- Telephones
- Low-voltage circuits

Operating Temperature

- -20°C to +80°C (AWM)
- -20°C to +75°C (CMG)

Conductor Color Coding

- Chart E (page 532) for AWM 2464
- Chart D (page 531) for AWM 2576

Materials

- Stranded tinned copper conductors
- Semirigid PVC insulation
- Slate PVC jacket

Availability

100 ft (30.5 m)
500 ft (152 m)
1000 ft (305 m)

Bulk

(Minimums may apply)

UL AWM 2464, UL CMG

24 AWG (0.22 mm²)

Stranding: 7/32 (7 x 0.20 mm)
Insulation thickness: 0.010 (0.25 mm)
Color Code E

Part No.	Conductors	Nominal Diameter		Jacket Thickness	
		Inch	mm	Inch	mm
M38902	2	0.155	3.94	0.032	0.81
M38903	3	0.162	4.11	0.032	0.81
M38904	4	0.173	4.39	0.032	0.81
M38906	6	0.200	5.08	0.032	0.81
M38908	8	0.213	5.41	0.032	0.81
M38910	10	0.243	6.17	0.032	0.81
M38915	15	0.269	6.83	0.032	0.81
M38920	20	0.297	7.54	0.032	0.81
M38925	25	0.331	8.41	0.032	0.81
M38930	30	0.349	8.86	0.032	0.81
M38940	40	0.389	9.88	0.032	0.81
M38950	50	0.426	10.82	0.032	0.81

UL AWM 2576, UL CMG

22 AWG (0.35 mm²)

Stranding: 7/30 (7 x 0.25 mm)
Insulation thickness: 0.010 (0.25 mm)
Color Code D

Part No.	Conductors	Nominal Diameter		Jacket Thickness	
		Inch	mm	Inch	mm
M33302	2	0.164	4.16	0.032	0.81
M33303	3	0.175	4.45	0.032	0.81
M33304	4	0.188	4.78	0.032	0.81
M33305	5	0.203	5.16	0.032	0.81
M33306	6	0.218	5.54	0.032	0.81
M33308	8	0.233	5.92	0.032	0.81
M33310	10	0.267	6.78	0.032	0.81
M33312	12	0.275	6.99	0.032	0.81
M33315	15	0.297	7.54	0.032	0.81
M33320	20	0.329	8.36	0.032	0.81
M33325	25	0.367	9.32	0.032	0.81
M33330	30	0.388	9.86	0.032	0.81
M33340	40	0.432	10.97	0.032	0.81
M33350	50	0.481	12.22	0.035	0.89
M33360	60	0.523	13.28	0.035	0.89



Manhattan™ Audio/Video Cable

300 V Spiral Wrap Copper Shield, Multiconductor, PVC, PVC

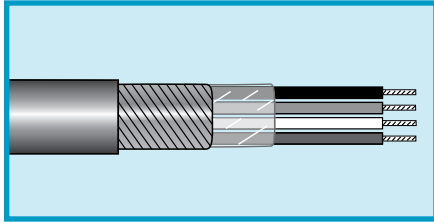

UL AWM 2095
UL AWM 1108
 (Single conductor)
UL CMG
CSA CMG FT4

Applications

- Audio and RF frequencies

Operating Temperature

- -20°C to +80°C (AWM)
- -20°C to +75°C (CMG)

Conductor Color Coding

- 1 Black, 2 Red, 3 White, 4 Green, 5 Yellow, 6 Blue
- Part No. M13282: 1 Red, 2 White

Materials

- Stranded tinned copper conductors
- PVC insulation
- Spiral wrapped tinned copper shield, 90% coverage
- Slate PVC jacket

Availability

100 ft (30.5 m)
 500 ft (152 m)
 1000 ft (305 m)
 Bulk, cut to length
 (Minimums may apply)

22 AWG (0.35 mm²)

Stranding: 7/30 (7 x 0.25 mm)
 Insulation thickness: 0.016 (0.41 mm)

Part No.	Conductors	Nominal Diameter		Jacket Thickness	
		Inch	mm	Inch	mm
M3261	1	0.112	2.84	0.020	0.51
M3262	2	0.177	4.50	0.020	0.51
M3263	3	0.187	4.75	0.020	0.51
M3264	4	0.206	5.23	0.020	0.51
M3266	6	0.243	6.17	0.020	0.51

20 AWG (0.50 mm²)

Stranding: 10/30 (10 x 0.25 mm)
 Insulation thickness: 0.016 (0.41 mm)

Part No.	Conductors	Nominal Diameter		Jacket Thickness	
		Inch	mm	Inch	mm
M3271	1	0.119	3.02	0.020	0.51
M3272	2	0.191	4.85	0.020	0.51
M3273	3	0.202	5.13	0.020	0.51
M3274	4	0.223	5.66	0.020	0.51
M3276	6	0.264	6.71	0.020	0.51

20 AWG (0.56 mm²)

Stranding: 7/28 (10 x 0.32 mm)
 Insulation thickness: 0.016 (0.41 mm)

Part No.	Conductors	Nominal Diameter		Jacket Thickness	
		Inch	mm	Inch	mm
M13272	2	0.203	5.16	0.025	0.64

18 AWG (0.81 mm²)

Stranding: 16/30 (16 x 0.25 mm)
 Insulation thickness: 0.016 (0.41 mm)

Part No.	Conductors	Nominal Diameter		Jacket Thickness	
		Inch	mm	Inch	mm
M3281	1	0.129	3.28	0.020	0.51
M3282	2	0.214	5.44	0.020	0.51
M3283	3	0.226	5.74	0.020	0.51
M3284	4	0.247	6.27	0.020	0.51



Manhattan™ Audio/Video Cable

300 V Spiral Wrap Copper Shield, Multiconductor, PVC, PVC

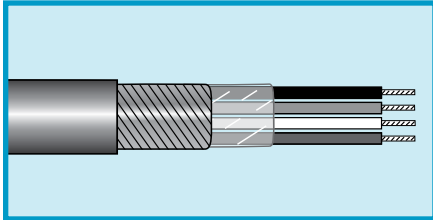

- UL AWM 2095
- UL AWM 1108
- (Single conductor)
- UL CMG
- CSA CMG FT4

Applications

- Audio and RF frequencies

Operating Temperature

- -20°C to +80°C (AWM)
- -20°C to +75°C (CMG)

Conductor Color Coding

- 1 Black, 2 Red, 3 White, 4 Green, 5 Yellow, 6 Blue
- Part No. M13282: 1 Red, 2 White

Materials

- Stranded tinned copper conductors
- PVC insulation
- Spiral wrapped tinned copper shield, 90% coverage
- Slate PVC jacket

Availability

100 ft (30.5 m)
 500 ft (152 m)
 1000 ft (305 m)
 Bulk, cut to length
 (Minimums may apply)

18 AWG (0.89 mm²)

Stranding: 7/26 (7 x 0.40 mm)
 Insulation thickness: 0.022 (0.56 mm)

Part No.	Conductors	Nominal Diameter		Jacket Thickness	
		Inch	mm	Inch	mm
M13282	2	0.256	6.50	0.028	0.71
M13283	3	0.270	6.86	0.028	0.71

16 AWG (1.32 mm²)

Stranding: 26/30 (26 x 0.25 mm)
 Insulation thickness: 0.016 (0.41 mm)

Part No.	Conductors	Nominal Diameter		Jacket Thickness	
		Inch	mm	Inch	mm
M3287	2	0.240	6.10	0.025	0.64
M3288	3	0.254	6.45	0.025	0.64

16 AWG (1.32 mm²)

Stranding: 19/0.0117 (19 x 0.30 mm)
 Insulation thickness: 0.023 (0.58 mm)

Part No.	Conductors	Nominal Diameter		Jacket Thickness	
		Inch	mm	Inch	mm
M13287	2	0.286	7.26	0.030	0.76

14 AWG (2.08 mm²)

Stranding: 41/30 (41 x 0.25 mm)
 Insulation thickness: 0.020 (0.51 mm)

Part No.	Conductors	Nominal Diameter		Jacket Thickness	
		Inch	mm	Inch	mm
M3289*	2	0.295	7.49	0.025	0.64
M3290*	3	0.312	7.92	0.025	0.64

*450 V.



Manhattan™ Audio/Video Cable

300 V Braid Shield, Multiconductor, PVC, PVC

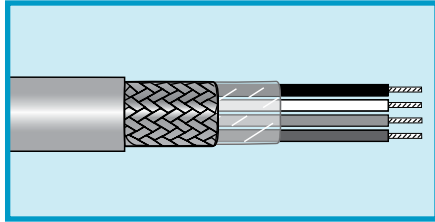

UL AWM 2095, 2464
CSA CMG FT4

Applications

- Audio and sound systems experiencing high flexing and needing additional tensile strength

Operating Temperature

- -20°C to +80°C (AMW)
- -20°C to +75°C (CMG)

Conductor Color Coding

- Chart D (page 531), unless otherwise noted

Materials

- Stranded tinned copper conductors
- PVC insulation
- Tinned copper braid shield, 85% coverage
- Slate PVC jacket

Availability

100 ft (30.5 m)
500 ft (152 m)
1000 ft (305 m)
Bulk, cut to length
(Minimums may apply)

UL 2095

22 AWG (0.035mm²)

Stranding: 7/30 (7 x 0.25 mm)
Insulation thickness: 0.016 (0.41 mm)

Part No.	Conductors	Nominal Diameter		Jacket Thickness	
		Inch	mm	Inch	mm
M3202	2	0.189	4.80	0.020	0.51
M13203	3	0.199	5.05	0.020	0.51
M3204	4	0.215	5.46	0.020	0.51

UL 2095

20 AWG (0.56 mm²)

Stranding: 7/28 (7 x 0.32 mm)
Insulation thickness: 0.016 (0.41 mm)

Part No.	Conductors	Nominal Diameter		Jacket Thickness	
		Inch	mm	Inch	mm
M3206	2	0.205	5.21	0.020	0.51
M3207	3	0.216	5.49	0.020	0.51
M3208	4	0.234	5.94	0.020	0.51
M13209*	6	0.300	7.62	0.032	0.81
M13210*	12	0.396	10.06	0.040	1.02

*UL AWM 2464. Conductor color code Chart F (page 532).

UL 2095

18 AWG (0.81 mm²)

Stranding: 16/30 (16 x 0.25 mm)
Insulation thickness: 0.016 (0.41 mm)

Part No.	Conductors	Nominal Diameter		Jacket Thickness	
		Inch	mm	Inch	mm
M3212	2	0.223	5.66	0.020	0.51
M3213	3	0.235	5.97	0.020	0.51
M3214	4	0.256	6.50	0.020	0.51

UL 2095

16 AWG (1.32 mm²)

Stranding: 19/0.0117 (19 x 0.30 mm)
Insulation thickness: 0.016 (0.41 mm)

Part No.	Conductors	Nominal Diameter		Jacket Thickness	
		Inch	mm	Inch	mm
M3216	2	0.247	6.27	0.020	0.51
M3217	3	0.261	6.63	0.020	0.51



Manhattan™ Audio/Video Cable

300 V Braid Shield, Multiconductor, PVC, PVC

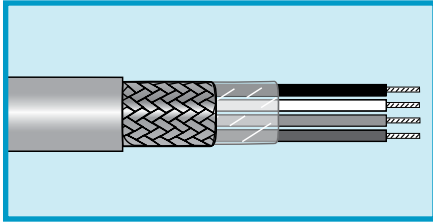

**UL AWM 2095, 2464
CSA CMG FT4**

Applications

- Audio and sound systems experiencing high flexing and needing additional tensile strength

Operating Temperature

- -20°C to +80°C (AMW)
- -20°C to +75°C (CMG)

Conductor Color Coding

- Chart D (page 531), unless otherwise noted

Materials

- Stranded tinned copper conductors
- PVC insulation
- Tinned copper braid shield, 85% coverage
- Slate PVC jacket

Availability

100 ft (30.5 m)
500 ft (152 m)
1000 ft (305 m)
Bulk, cut to length
(Minimums may apply)

450 V; Not UL Recognized

14 AWG (2.08 mm²)

Stranding: 41/30 (41 x 0.25 mm)
Insulation thickness: 0.020 (0.51 mm)

Part No.	Conductors	Nominal Diameter		Jacket Thickness	
		Inch	mm	Inch	mm
M33218	2	0.299	7.59	0.020	0.51
M33219	3	0.317	8.05	0.020	0.51

450 V; Not UL Recognized

12 AWG (3.29 mm²)

Stranding: 65/30 (65 x 0.25 mm)
Insulation thickness: 0.020 (0.51 mm)

Part No.	Conductors	Nominal Diameter		Jacket Thickness	
		Inch	mm	Inch	mm
M33220	2	0.337	8.56	0.020	0.51
M33221	3	0.358	9.09	0.020	0.51



Manhattan™ Audio/Video Cable

300 V Foil Shield, Multiconductor, PE or SR-PVC, PVC

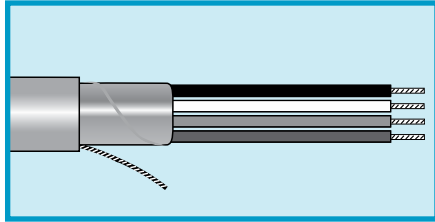

**UL AWM 2092, 2093, 2094,
2464, 20253**
UL CM, CMG, CL2
CSA CMG FT4

Applications

- Lightweight, low-cost small-diameter cable for audio and sound systems

Operating Temperature

- -20°C to +80°C (AWM 2464, 20253)
- -20°C to +75°C (CM, CMG)
- -20°C to +60°C (AWM 2092, 2093, 2094)

Conductor Color Coding

(Unless noted)

- 2-conductor: Black, clear
- 3-conductor: Black, red, clear
- 4-conductor: Black, red, white, green

Materials

- Polyethylene or semirigid PVC insulation (see tables)
- Aluminum/polyester foil shield, 25% overlap min.
Foil facing inward
Stranded tinned copper drain wire (see tables for size)
- Slate PVC jacket

Availability

100 ft (30.5 m)
500 ft (152 m)
1000 ft (305 m)
Bulk, cut to length
(Minimums may apply)



Polyethylene Insulation

24 AWG (0.22 mm²)

Stranding: 7/32 (7 x 0.20 mm)
Insulation thickness: 0.016 (0.41 mm)
24 AWG (0.22 mm²) drain wire

Part No.	Conductors	Nominal Diameter		Jacket Thickness		Approval	Color Code
		Inch	mm	Inch	mm		
M13222	2	0.166	4.22	0.025	0.64	2092, CM	Black, Clear

Mutual capacitance: 18 pF/ft (59 pF/m)
Ground capacitance: 32 pF/ft (105 pF/m)

Semi-Rigid PVC Insulation

24 AWG (0.22 mm²)

Stranding: 7/32 (7 x 0.20 mm)
Insulation thickness: 0.010 (0.51 mm)
24 AWG (0.22 mm²) drain wire

Part No.	Conductors	Nominal Diameter		Jacket Thickness		Approval	Color Code
		Inch	mm	Inch	mm		
M39024	3	0.166	4.22	0.032	0.81	2464, CMG	O
M39025	4	0.174	4.42	0.032	0.81	2464, CMG	O
M39026	5	0.187	4.75	0.032	0.81	2464, CMG	O
M39027	6	0.201	5.11	0.032	0.81	2464, CMG	O
M39028	7	0.201	5.11	0.032	0.81	2464, CMG	O
M39029	8	0.214	5.44	0.032	0.81	2464, CMG	O
M39030	9	0.228	5.79	0.032	0.81	2464, CMG	O
M39031	10	0.247	6.27	0.032	0.81	2464, CMG	O
M39032	15	0.273	6.93	0.032	0.81	2464, CMG	F
M39033	20	0.301	7.65	0.032	0.81	2464, CMG	F
M39034	25	0.335	8.51	0.032	0.81	2464, CMG	F
M39035	30	0.369	9.37	0.040	1.02	2464, CMG	F
M39036	40	0.409	10.39	0.040	1.02	2464, CMG	F
M39037	50	0.456	11.58	0.045	1.14	2464, CMG	F

Mutual capacitance: 32 pF/ft (105 pF/m)
Ground capacitance: 58 pF/ft (190.3 pF/m)

Polyethylene Insulation

22 AWG (0.35 mm²)

Stranding: 7/30 (7 x 0.25 mm)
Insulation thickness: 0.016 (0.41 mm)
22 AWG (0.35 mm²) drain wire

Part No.	Conductors	Nominal Diameter		Jacket Thickness		Approvals
		Inch	mm	Inch	mm	
M13226	2	0.178	4.52	0.025	0.64	2092, CM
M13227	3	0.204	5.18	0.033	0.84	2093, CM

Mutual capacitance: 20 pF/ft (65.6 pF/m)
Ground capacitance: 36 pF/ft (118.1 pF/m)

Manhattan™ Audio/Video Cable

300 V Foil Shield, Multiconductor, PE or SR-PVC, PVC

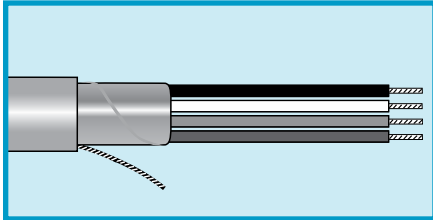

UL AWM 2092, 2093, 2094, 2464, 20253
UL CM, CMG, CL2
CSA CMG FT4

Applications

- Lightweight, low-cost small-diameter cable for audio and sound systems

Operating Temperature

- -20°C to +80°C (AWM 2464, 20253)
- -20°C to +75°C (CM, CMG)
- -20°C to +60°C (AWM 2092, 2093, 2094)

Conductor Color Coding

(Unless noted)

- 2-conductor: Black, clear
- 3-conductor: Black, red, clear
- 4-conductor: Black, red, white, green

Materials

- Polyethylene or semirigid PVC insulation (see tables)
- Aluminum/polyester foil shield, 25% overlap min.
Foil facing inward
Stranded tinned copper drain wire (see tables for size)
- Slate PVC jacket

Availability

100 ft (30.5 m)
 500 ft (152 m)
 1000 ft (305 m)
 Bulk, cut to length
 (Minimums may apply)

PVC Insulation

22 AWG (0.35 mm²)

Stranding: 7/30 (7 x 0.25 mm)
 Insulation thickness: 0.013 (0.33 mm)
 22 AWG (0.35 mm²) drain wire

Part No.	Conductors	Nominal Diameter		Jacket Thickness		Approvals
		Inch	mm	Inch	mm	
M13229	2	0.189	4.80	0.035	0.64	2464, CMG

Mutual capacitance: 48 pF/ft (157.4 pF/m)
 Ground capacitance: 86 pF/ft (282.1 pF/m)

Color code: black, red.

Polyethylene Insulation

20 AWG (0.56 mm²)

Stranding: 7/28 (7 x 0.32 mm)
 Insulation thickness: 0.016 (0.41 mm)
 20 AWG (0.56 mm²) drain wire

Part No.	Conductors	Nominal Diameter		Jacket Thickness		Approvals
		Inch	mm	Inch	mm	
M13232	2	0.200	5.08	0.028	0.71	2092, CM
M13233	3	0.221	5.61	0.033	0.84	2093, CM

Mutual capacitance: 23 pF/ft (75.4 pF/m)
 Ground capacitance: 41 pF/ft (134.5 pF/m)

Polyethylene Insulation

18 AWG (0.81 mm²)

Stranding: 16/30 (16 x 0.25 mm)
 Insulation thickness: 0.019 (0.48 mm)
 20 AWG (0.56 mm²) drain wire

Part No.	Conductors	Nominal Diameter		Jacket Thickness		Approvals
		Inch	mm	Inch	mm	
M13242	2	0.230	5.84	0.028	0.71	2092, CM
M13243	3	0.253	6.43	0.033	0.84	2093, CM

Mutual capacitance: 24.1 pF/ft (79.1 pF/m)
 Ground capacitance: 43 pF/ft (141.1 pF/m)

SR-PVC Insulation

18 AWG (0.96 mm²)

Stranding: 19/30 (19 x 0.25 mm)
 Insulation thickness: 0.010 (0.25 mm)
 20 AWG (0.56 mm²) drain wire

Part No.	Conductors	Nominal Diameter		Jacket Thickness		Approvals
		Inch	mm	Inch	mm	
M13244	4	0.249	6.32	0.035	0.89	2464, CMG

Mutual capacitance: 47 pF/ft (154.2 pF/m)
 Ground capacitance: 85 pF/ft (278.9 pF/m)



Manhattan™ Audio/Video Cable

300 V Foil Shield, Multiconductor, PE or SR-PVC, PVC

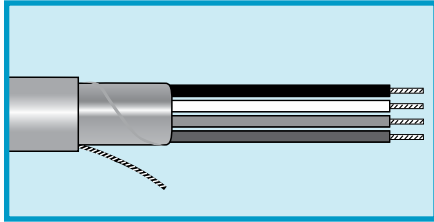

**UL AWM 2092, 2093, 2094,
2464, 20253**
UL CM, CMG, CL2
CSA CMG FT4

Applications

- Lightweight, low-cost small-diameter cable for audio and sound systems

Operating Temperature

- -20°C to +80°C (AWM 2464, 20253)
- -20°C to +75°C (CM, CMG)
- -20°C to +60°C (AWM 2092, 2093, 2094)

Conductor Color Coding

(Unless noted)

- 2-conductor: Black, clear
- 3-conductor: Black, red, clear
- 4-conductor: Black, red, white, green

Materials

- Polyethylene or semirigid PVC insulation (see tables)
- Aluminum/polyester foil shield, 25% overlap min.
Foil facing inward
Stranded tinned copper drain wire (see tables for size)
- Slate PVC jacket

Availability

100 ft (30.5 m)
500 ft (152 m)
1000 ft (305 m)
Bulk, cut to length
(Minimums may apply)

Polyethylene Insulation

16 AWG (1.32 mm²)

Stranding: 19/0.0117 (19 x 0.30 mm)
Insulation thickness: 0.032 (0.81 mm)
18 AWG (0.81 mm²) drain wire

Part No.	Conductors	Nominal Diameter		Jacket Thickness		Approvals
		Inch	mm	Inch	mm	
M13247	2	0.317	8.05	0.032	0.81	20253, CM, CL2
M13248	3	0.336	8.53	0.032	0.81	20253, CM, CL2

Mutual capacitance: 20.5 pF/ft (67.2 pF/m)
Ground capacitance: 37 pF/ft (121.4 pF/m)

Polyethylene Insulation

14 AWG (2.08 mm²)

Stranding: 19/0.0147 (19 x 0.37 mm)
Insulation thickness: 0.032 (0.81 mm)
16 AWG (1.31 mm²) drain wire

Part No.	Conductors	Nominal Diameter		Jacket Thickness		Approvals
		Inch	mm	Inch	mm	
M13249	2	0.345	8.78	0.035	0.89	20253, CM, CL2

Mutual capacitance: 22.5 pF/ft (73.8 pF/m)
Ground capacitance: 40 pF/ft (131.2 pF/m)

Polyethylene Insulation

12 AWG (3.29 mm²)

Stranding: 19/0.0185 (19 x 0.47 mm)
Insulation thickness: 0.037 (0.81 mm)
14 AWG (2.08 mm²) drain wire

Part No.	Conductors	Nominal Diameter		Jacket Thickness		Approvals
		Inch	mm	Inch	mm	
M13250	2	0.421	10.69	0.040	1.02	20253, CM, CL2

Mutual capacitance: 25 pF/ft (82 pF/m)
Ground capacitance: 44 pF/ft (144.3 pF/m)



Manhattan™ Audio/Video Cable

300 V Foil Shield, Multiconductor, PVC, PVC

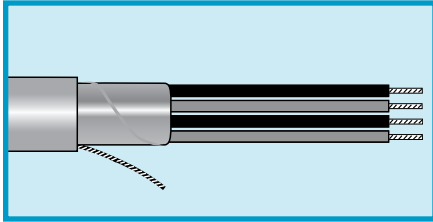

20 AWG (0.56 mm ²)					
Stranding: 7/28 (7 x 0.32 mm)					
Insulation thickness: 0.013 (0.33 mm)					
Part No.	Conductors	Nominal Diameter		Jacket Thickness	
		Inch	mm	Inch	mm
M14429	2	0.199	5.05	0.032	0.81

Mutual capacitance: 54 pF/ft (177.2 pF/m)
Ground capacitance: 97 pF/ft (318.2 pF/m)

UL AWM 2464
UL CMG
CSA CMG FT4

Applications

- Audio, broadcast, and sound systems
- Instrumentation

Operating Temperature

- -20°C to +80°C (AWM)
- -20°C to +75°C (CMG)

Conductor Color Coding

- 1 Black, 2 Red

Materials

- Stranded tinned copper conductors
- PVC insulation
- Aluminum/polyester foil shield, 25% overlap min.
Foil facing outward
- 22 AWG (0.35 mm²) stranded tinned copper drain wire
- Slate PVC jacket

Availability

Bulk, cut to length
(Minimums may apply)



Manhattan™ Audio/Video Cable

300 V Foil Shield, Multiconductor, PP, PVC
Miniature

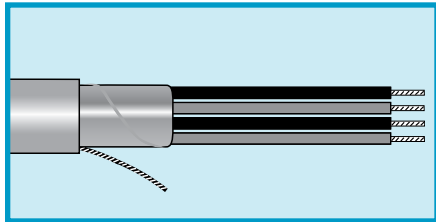

UL CM
CSA CM

Applications

- Audio, broadcast, and sound systems
- Instrumentation

Operating Temperature

- -20°C to +75°C

Conductor Color Coding

- 1 Black, 2 Red

Materials

- Solid or stranded tinned copper conductors
- Polypropylene insulation
- Aluminum/polyester foil shield, 25% overlap min.
Foil facing outward
- Stranded tinned copper drain wire equal in size to conductor
- Slate PVC jacket (except black where noted)

Availability

100 ft (30.5 m)
500 ft (152 m)
1000 ft (305 m)
Bulk, cut to length
(Minimums may apply)

24 AWG (0.22 mm²)

Stranding: 7/32 (7 x 0.20 mm)
Insulation thickness: 0.008 (0.20 mm)

Part No.	Conductors	Nominal Diameter		Jacket Thickness	
		Inch	mm	Inch	mm
M14328*	2	0.124	3.15	0.020	0.51

Mutual capacitance: 25 pF/ft (82 pF/m)
Ground capacitance: 45 pF/ft (147.6 pF/m)

*Black jacket.

22 AWG (0.35 mm²)

Stranding: Solid
Insulation thickness: 0.008 (0.20 mm)

Part No.	Conductors	Nominal Diameter		Jacket Thickness	
		Inch	mm	Inch	mm
M4325	2	0.122	3.10	0.018	0.46

Mutual capacitance: 28 pF/ft (91.8 pF/m)
Ground capacitance: 50 pF/ft 164 pF/m)

22 AWG (0.35 mm²)

Stranding: 7/30 (7 x 0.25 mm)
Insulation thickness: 0.008 (0.20 mm)

Part No.	Conductors	Nominal Diameter		Jacket Thickness	
		Inch	mm	Inch	mm
M4326	2	0.139	3.53	0.020	0.51
M14327*					

Mutual capacitance: 28 pF/ft (91.8 pF/m)
Ground capacitance: 50 pF/ft 164 pF/m)

*Black jacket.



Manhattan™ Audio/Video Cable

300 V Unshielded and Shielded, Multiconductor Composite, PVC/PE/PP, PVC

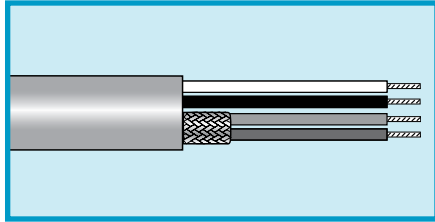

UL AWM 2717 (300 V)
UL AWM 2094, 2576 (150 V)
UL CM, CMG
CSA CMG, CMG

Operating Temperature

- -20°C to +80°C (AWM 2717)
- -20°C to +75°C (CM, CMG, except where noted)
- -20°C to +60°C (AWM 2094)

Conductor Color Coding

- See tables

Materials

- Stranded tinned copper conductors
- PVC insulation (polypropylene or polyethylene, as noted)
- Aluminum/polyester foil shield, 25% minimum overlap
- Stranded tinned copper drain wire (see tables for size)
- PVC jacket (see tables for colors)

Availability

100 ft (30.5 m)
 500 ft (152 m)
 1000 ft (305 m)
 (Minimums may apply)

22 AWG Composite Shielded and Unshielded, UL CM, Slate Jacket

22 AWG (0.35 mm²)

Stranding: 7/30 (7 x 0.25 mm)
 22 AWG (0.035 mm²) drain wire (M4475)
 24 AWG (0.22 mm²) drain wire (M4451)

Part No.	Conductors	Nominal Diameter		Insulation Thickness		Jacket Thickness		Configuration		Insulation
		Inch	mm	Inch	mm	Inch	mm	Shielded	Unshielded	
M4475	3	0.190	4.83	0.013	0.33	0.032	0.81	2 Black, White	1 Brown	PVC
M4451	4	0.161	4.09	0.008	0.20	0.019	0.48	2 Red, Black	2 Green, White	PP

20 AWG Composite Shielded and Unshielded, UL CMG, Slate Jacket

20 AWG (0.56 mm²)

Stranding: 7/28 (7 x 0.32 mm)
 Insulation Thickness: 0.015 (0.38 mm)
 22 AWG (0.35 mm²) drain wire

Part No.	Pairs	Nominal Diameter		Jacket Thickness		Configuration		Insulation
		Inch	mm	Inch	mm	Shielded	Unshielded	
M4452	4	0.226	5.74	0.028	0.71	2 Red, Black	2 Green, White	PVC

22 AWG Composite Shielded and Unshielded, AWM 2717 and UL CM, Polypropylene Insulation, Slate Jacket

22 AWG (0.35 mm²)

Stranding: 7/30 (7 x 0.25 mm)
 24 AWG (0.22 mm²) drain wire

Part No.	Pairs	Nominal Diameter		Insulation Thickness		Jacket Thickness		Configuration	
		Inch	mm	Inch	mm	Inch	mm	Shielded	Unshielded
M14474	2	0.243	5.17	0.010	0.25	0.028	0.71	2 Red, Black	—
M14476*	2	0.220	5.59	0.008	0.20	0.030	0.81	1 Red, Black	1 Green, White

*Not CMG



Manhattan™ Audio/Video Cable

300 V Unshielded and Shielded, Multiconductor Composite, PVC/PE/PP, PVC

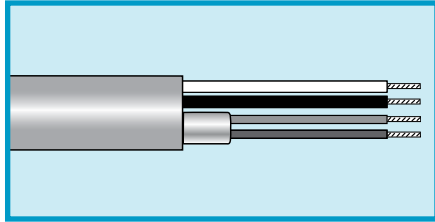

UL AWM 2717 (300 V)
UL AWM 2094, 2576 (150 V)
UL CM, CMG
CSA CMG, CMG

Operating Temperature

- -20°C to +80°C (AWM 2717)
- -20°C to +75°C (CM, CMG, except where noted)
- -20°C to +60°C (AWM 2094)

Conductor Color Coding

- See tables

Materials

- Stranded tinned copper conductors
- PVC insulation (polypropylene or polyethylene, as noted)
- Aluminum/polyester foil shield, 25% minimum overlap
- Stranded tinned copper drain wire (see tables for size)
- PVC jacket (see tables for colors)

Availability

100 ft (30.5 m)
 500 ft (152 m)
 1000 ft (305 m)
 (Minimums may apply)

24/22 AWG Composite Shielded and Unshielded, UL CM, Slate Jacket

		24 AWG (0.22 mm ²)				22 AWG (0.35 mm ²)				
		Stranding: 7/32 (7 x 0.20 mm) 22 AWG (0.35 mm ²) drain wire (M14477) 24 AWG (0.22 mm ²) drain wire (M14478)				Stranding: 7/30 (7 x 0.25 mm)				
Part No.	Conductors	Nominal Diameter		Insulation Thickness		Jacket Thickness		Configuration		Insulation
		Inch	mm	Inch	mm	Inch	mm	Shielded	Unshielded	
M14477	4 (24 AWG)	0.239	6.07	0.016	0.41	0.028	0.71	4**	—	PVC
	2 (22 AWG)							—	2 Blue, White	PVC
M14478*	8 (24 AWG)	0.295	7.49	0.012	0.30	0.030	0.81	8 [†]	—	PE
	2 (22 AWG)			0.015	0.38			—	2 White, Blue	PVC

*Cable has two quads of four shielded conductors, each quad individually shielded. One quad has a red shield; the other has a green shield. Not CMG.

**Conductor color coding: Black, green, red, yellow.

†Conductor color coding: Slate, white, blue, green, brown, red, yellow, orange.

22 AWG Shielded, UL CM, Brown Jacket

		22 AWG (0.35 mm ²)								
		Stranding: 7/30 (7 x 0.25 mm) Insulation Thickness 0.008 (0.20 mm) 22 AWG (0.35 mm ²) drain wire								
Part No.	Conductors	Nominal Diameter		Jacket Thickness		Configuration				Insulation
		Inch	mm	Inch	mm	Shielded	Unshielded			
M14475	3	0.143	3.63	0.020	0.51	3*	—			PP

*Conductor color coding: Black, red, white.



Manhattan™ Audio/Video Cable

300 V Unshielded and Shielded, Multiconductor Composite, PVC/PE, PVC

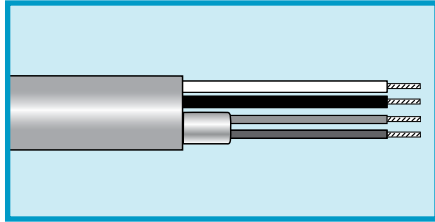

UL AWM 2717 (300 V)
UL AWM 2094, 2576 (150 V)
UL CM, CMG
CSA CMG, CMG

Operating Temperature

- -20°C to +80°C (AWM 2717)
- -20°C to +75°C (CM, CMG, except where noted)
- -20°C to +60°C (AWM 2094)

Conductor Color Coding

- See tables

Materials

- Stranded tinned copper conductors
- PVC or PE insulation
- Aluminum/polyester foil shield, 25% minimum overlap
- Stranded tinned copper drain wire (see tables for size)
- PVC jacket (see tables for colors)

Availability

100 ft (30.5 m)
 500 ft (152 m)
 1000 ft (305 m)
 (Minimums may apply)

22 and 18 AWG Unshielded, UL CM Only, Slate Jacket

22 AWG (0.35 mm ²)		18 AWG (0.81 mm ²)					
Stranding: 7/30 (7 x 0.25 mm) Insulation thickness: 0.010 (0.25 mm)		Stranding: 16/30 (16 x 0.25 mm) Insulation thickness: 0.018 (0.46 mm)					
Part No.	Conductors*		Nominal Diameter		Jacket Thickness		Insulation
	22 AWG	18 AWG	Inch	mm	Inch	mm	
M4406	4	2	0.255	6.48	0.032	0.81	PVC

Conductor color coding:
 22 AWG: Red, green, brown, blue.
 18 AWG: Black, white.

20 Foil Shielded and 18 AWG Unshielded, AWM 2094, CM, Beige Jacket

20 AWG (0.56 mm ²)		18 AWG (0.81 mm ²)					
Stranding: 7/28 (7 x 0.32 mm) Insulation thickness: 0.20 (0.50 mm) 22 AWG (0.35 mm ²) drain wire		Stranding: 16/30 (16 x 0.25 mm) Insulation thickness: 0.019 (0.48 mm)					
Part No.	Conductors		Nominal Diameter		Jacket Thickness		Insulation
	20 AWG	18 AWG	Inch	mm	Inch	mm	
M13291	2	2	0.264	6.71	0.032	0.81	PE

Conductor color coding:
 22 AWG: Black, red.
 18 AWG: Green, white.



Manhattan™ Security and Data Cable

300 V Unshielded, Multiconductor, PVC, PVC

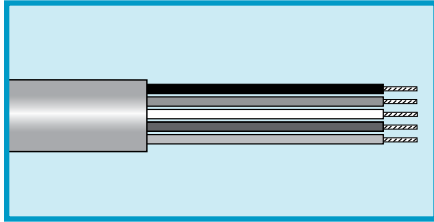

UL CMR
CSA CMR

Operating Temperature

- -20°C to +75°C

Conductor Color Coding

- 1 Black, 2 Red, 3 White, 4 Green, 5 Brown, 6 Blue, 7 Orange, 8 Yellow, 9 Violet, 10 Slate

Materials

- Stranded bare copper conductors
- PVC insulation
- Slate PVC jacket

Availability

100 ft (30.5 m)
500 ft (152 m)
1000 ft (305 m)
Bulk, cut to length
(Minimums may apply)

22 AWG (0.35 mm²)

Stranding: 7/30 (7 x 0.25 mm)
Insulation thickness: 0.010 (0.25 mm)

Part No.	Conductors	Nominal Diameter		Jacket Thickness	
		Inch	mm	Inch	mm
M213302	2	0.130	3.30	0.015	0.38
M213303	3	0.138	3.51	0.015	0.38
M213304	4	0.151	3.84	0.015	0.38
M213305	5	0.166	4.22	0.015	0.38
M213308	8	0.196	4.98	0.015	0.38

20 AWG (0.56 mm²)

Stranding: 7/28 (7 x 0.32 mm)
Insulation thickness: 0.010 (0.25 mm)

Part No.	Conductors	Nominal Diameter		Jacket Thickness	
		Inch	mm	Inch	mm
M213402	2	0.146	3.71	0.015	0.38
M213403	3	0.155	3.94	0.015	0.38
M213404	4	0.170	4.32	0.015	0.38

18 AWG (0.89 mm²)

Stranding: 7/26 (7 x 0.40 mm)
Insulation thickness: 0.010 (0.25 mm)

Part No.	Conductors	Nominal Diameter		Jacket Thickness	
		Inch	mm	Inch	mm
M213502	2	0.166	4.22	0.015	0.38
M213503	3	0.177	4.50	0.015	0.38
M213504	4	0.195	4.95	0.015	0.38

16 AWG (1.32 mm²)

Stranding: 19/0.0117 (19 x 0.30 mm)
Insulation thickness: 0.010 (0.25 mm)

Part No.	Conductors	Nominal Diameter		Jacket Thickness	
		Inch	mm	Inch	mm
M213572	2	0.188	4.77	0.015	0.38
M213573	3	0.200	5.08	0.015	0.38
M213574	4	0.221	5.61	0.015	0.38



Manhattan™ Security and Data Cable

300 V Foil Shielded, Multiconductor, PVC, PVC

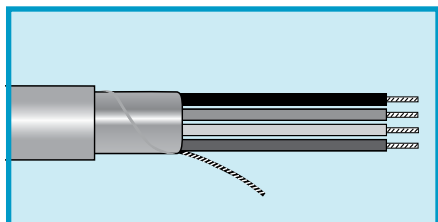

UL CMR
CSA CMR

Operating Temperature

- 20°C to +75°C

Conductor Color Coding

- 1 Black, 2 Red, 3 White, 4 Green, 5 Brown, 6 Blue, 7 Orange, 8 Yellow, 9 Violet, 10 Slate

Materials

- Stranded bare copper conductors
- PVC insulation
- Aluminum/polyester foil shield, 25% overlap min.
Foil facing outward
- Stranded tinned copper drain wire one even AWG size smaller than conductor (except 24 AWG, which is the same size as the conductors)
- Slate PVC jacket

Availability

100 ft (30.5 m)
500 ft (152 m)
1000 ft (305 m)
Bulk, cut to length
(Minimums may apply)

24 AWG (0.22 mm²)

Stranding: 7/32 (7 x 0.20 mm)
Insulation thickness: 0.010 (0.25 mm)

Part No.	Conductors	Nominal Diameter		Jacket Thickness	
		Inch	mm	Inch	mm
M239023	2	0.122	3.10	0.015	0.38
M239024	3	0.129	3.28	0.015	0.38
M239025	4	0.140	3.56	0.015	0.38

22 AWG (0.35 mm²)

Stranding: 7/30 (7 x 0.25 mm)
Insulation thickness: 0.010 (0.25 mm)

Part No.	Conductors	Nominal Diameter		Jacket Thickness	
		Inch	mm	Inch	mm
M113226	2	0.134	3.40	0.015	0.38
M113227	3	0.142	3.61	0.015	0.38

20 AWG (0.56 mm²)

Stranding: 7/28 (7 x 0.32 mm)
Insulation thickness: 0.010 (0.25 mm)

Part No.	Conductors	Nominal Diameter		Jacket Thickness	
		Inch	mm	Inch	mm
M113232	2	0.150	3.81	0.015	0.38
M113233	3	0.159	4.04	0.015	0.38

18 AWG (0.89 mm²)

Stranding: 7/26 (7 x 0.40 mm)
Insulation thickness: 0.010 (0.25 mm)

Part No.	Conductors	Nominal Diameter		Jacket Thickness	
		Inch	mm	Inch	mm
M113242	2	0.170	4.32	0.015	0.38
M113243	3	0.181	4.60	0.015	0.38
M113244	4	0.199	5.05	0.015	0.38

16 AWG (1.32 mm²)

Stranding: 19/0.0117 (7 x 0.30 mm)
Insulation thickness: 0.010 (0.25 mm)

Part No.	Conductors	Nominal Diameter		Jacket Thickness	
		Inch	mm	Inch	mm
M113247	2	0.192	4.88	0.015	0.38
M113248	3	0.204	5.18	0.015	0.38



Manhattan™ Security and Data Cable

300 V Unshielded, Multipair, PVC, PVC

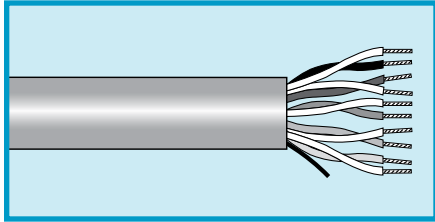

UL CMR
CSA CMR

Operating Temperature

- -20°C to +75°C

Conductor Color Coding

- Chart A1 (page 528)

Materials

- Stranded bare copper conductors
- PVC insulation
- Slate PVC jacket

Availability

100 ft (30.5 m)
500 ft (152 m)
1000 ft (305 m)
Bulk, cut to length
(Minimums may apply)

22 AWG (0.35 mm²)

Stranding: 7/30 (7 x 0.25 mm)
Insulation thickness: 0.010 (0.25 mm)

Part No.	Pairs	Nominal Diameter		Jacket Thickness	
		Inch	mm	Inch	mm
M2210	2	0.194	4.93	0.015	0.38
M2211	3	0.207	5.26	0.015	0.38
M2212	4	0.228	5.79	0.015	0.38

20 AWG (0.56 mm²)

Stranding: 7/28 (7 x 0.32 mm)
Insulation thickness: 0.010 (0.25 mm)

Part No.	Pairs	Nominal Diameter		Jacket Thickness	
		Inch	mm	Inch	mm
M2222	2	0.220	5.59	0.015	0.38
M2223	3	0.235	5.97	0.015	0.38
M2224	4	0.260	6.60	0.015	0.38
M2226	6	0.317	8.05	0.015	0.38

18 AWG (0.89 mm²)

Stranding: 7/26 (7 x 0.40 mm)
Insulation thickness: 0.010 (0.25 mm)

Part No.	Pairs	Nominal Diameter		Jacket Thickness	
		Inch	mm	Inch	mm
M2215	2	0.253	6.43	0.015	0.38
M2216	3	0.270	6.86	0.015	0.38
M2217	4	0.300	7.62	0.015	0.38



Manhattan™ Security and Data Cable

300 V, Individually Foil Shielded Pairs, Multipair, PVC, PVC

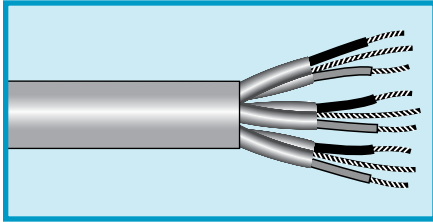

UL CMR
CSA CMR

Operating Temperature

- -20°C to +75°C

Conductor Color Coding

- Chart A1 (page 528)

Materials

- Stranded bare copper conductors
- PVC insulation
- Aluminum/polyester foil shield, 25% overlap min. Foil facing inward
- Stranded tinned copper drain wire one even AWG size smaller than conductor
- Slate PVC jacket

Availability

100 ft (30.5 m)
500 ft (152 m)
1000 ft (305 m)
Bulk, cut to length
(Minimums may apply)

22 AWG (0.35 mm ²)					
Stranding: 7/30 (7 x 0.25 mm)					
Insulation thickness: 0.010 (0.25 mm)					
Part No.	Pairs	Nominal Diameter		Jacket Thickness	
		Inch	mm	Inch	mm
M213102	2	0.229	5.82	0.020	0.51
M213103	3	0.244	6.20	0.020	0.51
M213104	4	0.269	6.83	0.020	0.51
M213106	6	0.325	8.26	0.020	0.51

20 AWG (0.56 mm ²)					
Stranding: 7/28 (7 x 0.32 mm)					
Insulation thickness: 0.010 (0.25 mm)					
Part No.	Pairs	Nominal Diameter		Jacket Thickness	
		Inch	mm	Inch	mm
M213142	2	0.257	6.53	0.020	0.51
M213143	3	0.274	6.96	0.020	0.51
M213144	4	0.303	7.70	0.020	0.51
M213146	6	0.367	9.32	0.020	0.51

18 AWG (0.89 mm ²)					
Stranding: 7/26 (7 x 0.40 mm)					
Insulation thickness: 0.010 (0.25 mm)					
Part No.	Pairs	Nominal Diameter		Jacket Thickness	
		Inch	mm	Inch	mm
M213172	2	0.292	7.42	0.020	0.51
M213173	3	0.312	7.92	0.020	0.51
M213174	4	0.345	8.76	0.020	0.51
M213176	6	0.420	10.67	0.020	0.51



Manhattan™ Security and Data Cable

300 V Overall Foil Shield, Multipair, PVC, PVC

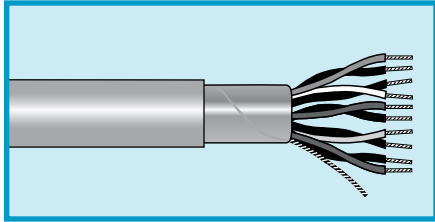

UL CMR
CSA CMR

Operating Temperature

- -20°C to +75°C

Conductor Color Coding

- Chart A1 (page 528)

Materials

- Stranded bare copper conductors
- PVC insulation
- Aluminum/polyester foil shield, 25% overlap min.
Foil facing outward
- Stranded tinned copper drain wire one even AWG size smaller than conductor (except 24 AWG, which is the same size as the conductors)
- Slate PVC jacket

Availability

100 ft (30.5 m)
500 ft (152 m)
1000 ft (305 m)
Bulk, cut to length
(Minimums may apply)

24 AWG (0.22 mm²)

Stranding: 7/32 (7 x 0.20 mm)
Insulation thickness: 0.010 (0.25 mm)

Part No.	Pairs	Nominal Diameter		Jacket Thickness	
		Inch	mm	Inch	mm
M213191	2	0.178	4.52	0.015	0.38
M213192	3	0.190	4.83	0.015	0.38
M213193	4	0.209	5.31	0.015	0.38

22 AWG (0.35 mm²)

Stranding: 7/30 (7 x 0.25 mm)
Insulation thickness: 0.010 (0.25 mm)

Part No.	Pairs	Nominal Diameter		Jacket Thickness	
		Inch	mm	Inch	mm
M213222	2	0.198	5.03	0.015	0.38
M213223	3	0.211	5.36	0.015	0.38
M213224	4	0.232	5.89	0.015	0.38

20 AWG (0.56 mm²)

Stranding: 7/28 (7 x 0.32 mm)
Insulation thickness: 0.010 (0.25 mm)

Part No.	Pairs	Nominal Diameter		Jacket Thickness	
		Inch	mm	Inch	mm
M213202	2	0.224	5.69	0.015	0.38
M213203	3	0.239	6.07	0.015	0.38
M213204	4	0.264	6.71	0.015	0.38
M213206	6	0.331	8.41	0.020	0.51

18 AWG (0.89 mm²)

Stranding: 7/26 (7 x 0.40 mm)
Insulation thickness: 0.010 (0.25 mm)

Part No.	Pairs	Nominal Diameter		Jacket Thickness	
		Inch	mm	Inch	mm
M213182	2	0.257	6.53	0.015	0.38
M213183	3	0.274	6.96	0.015	0.38
M213184	4	0.304	7.72	0.015	0.38



Manhattan™ Plenum Cable

300 V Overall Foil Shield, Multiconductor, PVC, PVC, Plenum Rated

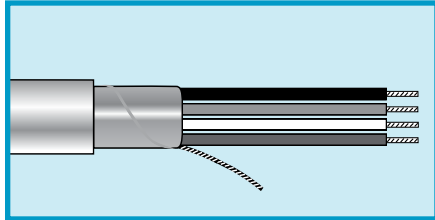

UL CMP
CSA CMP FT6

Operating Temperature

- -20°C to +75°C

Conductor Color Coding

- 1 Black, 2 Red, 3 White, 4 Green, 5 Brown, 6 Blue, 7 Orange, 8 Yellow, 9 Violet, 10 Slate

Materials

- Stranded bare copper conductors
- Plenum-rated PVC insulation
- Aluminum/polyester foil shield, 25% overlap min.
Foil facing outward
- Stranded tinned copper drain wire (see tables for size)
- White plenum-rated PVC jacket

Availability

100 ft (30.5 m)
500 ft (152 m)
1000 ft (305 m)
Bulk, cut to length
(Minimums may apply)

24 AWG (0.22 mm²)

Stranding: 7/32 (7 x 0.20 mm)
Insulation thickness: 0.010 (0.25 mm)
24 AWG (0.22 mm²) drain wire

Part No.	Conductors	Nominal Diameter		Jacket Thickness	
		Inch	mm	Inch	mm
M244837	2	0.122	3.10	0.015	0.38
M244838	3	0.129	3.28	0.015	0.38
M244839	4	0.140	3.56	0.015	0.38

22 AWG (0.35 mm²)

Stranding: 7/30 (7 x 0.25 mm)
Insulation thickness: 0.010 (0.25 mm)
24 AWG (0.22 mm²) drain wire

Part No.	Conductors	Nominal Diameter		Jacket Thickness	
		Inch	mm	Inch	mm
M244800	2	0.134	3.40	0.015	0.38
M244801	3	0.142	3.61	0.015	0.38
M244802	4	0.155	3.94	0.015	0.38
M244804	6	0.178	4.52	0.015	0.38
M244806	8	0.200	5.08	0.015	0.38
M244808	10	0.234	5.94	0.015	0.38

20 AWG (0.56 mm²)

Stranding: 7/28 (7 x 0.32 mm)
Insulation thickness: 0.010 (0.25 mm)
22 AWG (0.35 mm²) drain wire

Part No.	Conductors	Nominal Diameter		Jacket Thickness	
		Inch	mm	Inch	Mm
M244816	2	0.150	3.81	0.015	0.38
M244817	3	0.159	4.04	0.015	0.38
M244818	4	0.174	4.42	0.015	0.38



Manhattan™ Plenum Cable

300 V Overall Foil Shield, Multiconductor, PVC, PVC, Plenum Rated

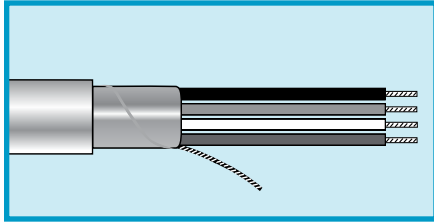

UL CMP
CSA CMP FT6

Operating Temperature

- -20°C to +75°C

Conductor Color Coding

- 1 Black, 2 Red, 3 White, 4 Green, 5 Brown, 6 Blue, 7 Orange, 8 Yellow, 9 Violet, 10 Slate

Materials

- Stranded bare copper conductors
- Plenum-rated PVC insulation
- Aluminum/polyester foil shield, 25% overlap min.
Foil facing outward
- Stranded tinned copper drain wire (see tables for size)
- White plenum-rated PVC jacket

Availability

100 ft (30.5 m)
500 ft (152 m)
1000 ft (305 m)
Bulk, cut to length
(Minimums may apply)

18 AWG (0.89 mm²)

Stranding: 7/26 (16 x 0.40 mm)
Insulation thickness: 0.010 (0.25 mm)
20 AWG (0.56 mm²) drain wire

Part No.	Conductors	Nominal Diameter		Jacket Thickness	
		Inch	mm	Inch	Mm
M244825	2	0.146	3.71	0.015	0.38
M244826	3	0.181	4.60	0.015	0.38
M244827	4	0.199	5.05	0.015	0.38

16 AWG (1.32 mm²)

Stranding: 19/0.0117 (19 x 0.30 mm)
Insulation thickness: 0.010 (0.25 mm)
18 AWG (0.89 mm²) drain wire

Part No.	Conductors	Nominal Diameter		Jacket Thickness	
		Inch	mm	Inch	mm
M244834	2	0.192	4.88	0.015	0.38
M244835	3	0.204	5.18	0.015	0.38
M244836	4	0.225	5.71	0.015	0.38



Manhattan™ Plenum Cable

300 V Overall Foil Shield, Multiconductor, FEP, PVDF, Plenum Rated

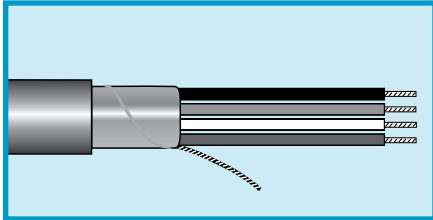

UL CMR
CSA CMP FT6

Operating Temperature

- -40°C to +125°C

Conductor Color Coding

- Chart D (page 531)

Materials

- Stranded tinned copper conductors
- FEP insulation
- Aluminum/polyester foil shield, 25% overlap min.
Foil facing outward
- Stranded tinned copper drain wire (see tables for size)
- Red PVDF jacket

Availability

100 ft (30.5 m)
500 ft (152 m)
1000 ft (305 m)
Bulk, cut to length
(Minimums may apply)

22 AWG (0.35 mm²)

Stranding: 7/30 (7 x 0.25 mm)
Insulation thickness: 0.006 (0.15 mm)
24 AWG (0.22 mm²) drain wire

Part No.	Conductors	Nominal Diameter		Jacket Thickness	
		Inch	mm	Inch	mm
M413226	2	0.118	3.00	0.015	0.38

18 AWG (0.96 mm²)

Stranding: 19/30 (19 x 0.25 mm)
Insulation thickness: 0.007 (0.18 mm)
20 AWG (0.56 mm²) drain wire

Part No.	Conductors	Nominal Diameter		Jacket Thickness	
		Inch	mm	Inch	mm
M413242	2	0.162	4.11	0.015	0.38



Manhattan™ Plenum Cable

300 V Overall Foil Shield, Multiconductor, FEP, FEP, Plenum Rated

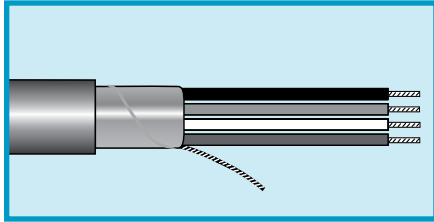

UL CMP
CSA CMP FT6

Operating Temperature

- -20°C to +150°C

Conductor Color Coding

- Chart F (page 532), unless noted

Materials

- Stranded tinned copper conductors
- FEP insulation
- Aluminum/polyester foil shield, 25% overlap min.
Foil facing outward
- Stranded tinned copper drain wire (see tables for size)
- Slate FEP jacket

Availability

100 ft (30.5 m)
500 ft (152 m)
1000 ft (305 m)
Bulk, cut to length
(Minimums may apply)

24 AWG (0.22 mm²)

Stranding: 7/32 (7 x 0.20 mm)
Insulation thickness: 0.006 (0.15 mm)
24 AWG (0.22 mm²) drain wire

Part No.	Conductors	Nominal Diameter		Jacket Thickness	
		Inch	mm	Inch	mm
M64837	2	0.096	2.44	0.010	0.25
M64838	3	0.102	2.59	0.010	0.25
M64839	4	0.111	2.82	0.010	0.25
M64840	5	0.122	3.10	0.010	0.25
M64841	6	0.133	3.38	0.010	0.25
M64842	7	0.133	3.38	0.010	0.25
M64843	8	0.168	4.26	0.012	0.30
M64844	9	0.159	4.04	0.012	0.30
M64845	10	0.172	4.37	0.012	0.30
M64846	12	0.178	4.52	0.012	0.30
M64847	15	0.193	4.90	0.012	0.30

22 AWG (0.35 mm²)

Stranding: 7/30 (7 x 0.25 mm)
Insulation thickness: 0.006 (0.15 mm)
24 AWG (0.22 mm²) drain wire

Part No.	Conductors	Nominal Diameter		Jacket Thickness	
		Inch	mm	Inch	mm
M64800	2	0.108	2.74	0.010	0.25
M64801	3	0.115	2.92	0.010	0.25
M64802	4	0.126	3.20	0.010	0.25
M64803	5	0.138	3.51	0.010	0.25
M64804	6	0.151	3.84	0.010	0.25
M64805	7	0.151	3.84	0.010	0.25
M64806	8	0.168	4.27	0.012	0.30
M64807	9	0.181	4.60	0.012	0.30
M64808	10	0.196	4.98	0.012	0.30
M64809	12	0.203	5.16	0.012	0.30
M64812	15	0.221	5.61	0.012	0.30



Manhattan™ Plenum Cable

300 V Overall Foil Shield, Multiconductor, FEP, FEP, Plenum Rated

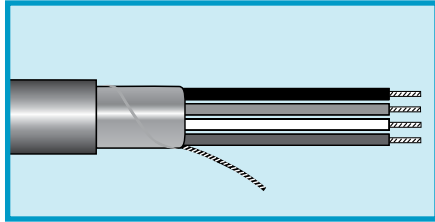

UL CMP
CSA CMP FT6

Operating Temperature

- 20°C to +150°C

Conductor Color Coding

- Chart F (page 532), unless noted

Materials

- Stranded tinned copper conductors
- FEP insulation
- Aluminum/polyester foil shield, 25% overlap min. Foil facing outward
- Stranded tinned copper drain wire (see tables for size)
- Slate FEP jacket

Availability

100 ft (30.5 m)
500 ft (152 m)
1000 ft (305 m)
Bulk, cut to length
(Minimums may apply)

-80 to +150°C Temperature Rating, Color Code D

22 AWG (0.35 mm²)

Stranding: 7/30 (7 x 0.25 mm)
Insulation thickness: 0.006 (0.15 mm)
24 AWG (0.22 mm²) drain wire

Part No.	Conductors	Nominal Diameter		Jacket Thickness	
		Inch	mm	Inch	mm
M613226	1	0.118	2.99	0.015	0.38

20 AWG (0.56 mm²)

Stranding: 7/28 (7 x 0.32 mm)
Insulation thickness: 0.006 (0.15 mm)
22 AWG (0.35 mm²) drain wire

Part No.	Conductors	Nominal Diameter		Jacket Thickness	
		Inch	mm	Inch	Mm
M64816	2	0.124	3.15	0.010	0.25
M64817	3	0.132	3.35	0.010	0.25
M64818	4	0.145	3.68	0.010	0.25
M64820	6	0.175	4.45	0.010	0.25
M64822	8	0.194	4.93	0.012	0.30
M64824	10	0.228	5.79	0.012	0.30

-80 to +150°C Temperature Rating, Color Code D

18 AWG (0.96 mm²)

Stranding: 19/30 (19 x 0.25 mm)
Insulation thickness: 0.007 (0.18 mm)
20 AWG (0.60 mm²) drain wire

Part No.	Conductors	Nominal Diameter		Jacket Thickness	
		Inch	mm	Inch	mm
M613242	2	0.162	4.11	0.015	0.38

18 AWG (0.89 mm²)

Stranding: 7/26 (16 x 0.40 mm)
Insulation thickness: 0.009 (0.23 mm)
20 AWG (0.56 mm²) drain wire

Part No.	Conductors	Nominal Diameter		Jacket Thickness	
		Inch	mm	Inch	mm
M64825	2	0.160	4.06	0.010	0.25
M64826	3	0.166	4.22	0.010	0.25
M64827	4	0.188	4.78	0.012	0.30
M64829	6	0.227	5.77	0.012	0.30
M64831	8	0.247	6.27	0.012	0.30

16 AWG (1.43 mm²)

Stranding: 7/24 (7 x 0.51 mm)
Insulation thickness: 0.009 (0.23 mm)
18 AWG (0.89 mm²) drain wire

Part No.	Conductors	Nominal Diameter		Jacket Thickness	
		Inch	mm	Inch	mm
M64834	2	0.180	4.57	0.010	0.25
M64835	3	0.196	4.98	0.012	0.30
M64836	4	0.217	5.51	0.012	0.30



Manhattan™ Plenum Cable

300 V Individually Foil Shielded Pairs, Multipair, PVC, PVC
Plenum Rated

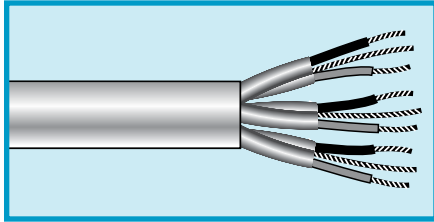

UL CMP
CSA CMP

Operating Temperature

- -20°C to +75°C

Conductor Color Coding

- Chart A1 (page 528)
(Part number M243473: Black, white, green/yellow)

Materials

- Stranded bare copper conductors
- Plenum-rated PVC insulation
- Aluminum/polyester foil shield, 25% overlap min.
Foil facing inward
- Stranded tinned copper drain wire (see tables for size)
- White plenum-rated PVC jacket

Availability

100 ft (30.5 m)
500 ft (152 m)
1000 ft (305 m)
Bulk, cut to length
(Minimums may apply)

22 AWG (0.35 mm ²)					
Stranding: 7/30 (7 x 0.25 mm) Insulation thickness: 0.007 (0.18mm) 24 AWG (0.22 mm ²) drain wire					
Part No.	Pairs	Nominal Diameter		Jacket Thickness	
		Inch	mm	Inch	Mm
M44473	2	0.192	4.88	0.015	0.38
M43103	3	0.211	5.36	0.015	0.38
M43106	6	0.301	7.65	0.024	0.60

22 AWG (0.35 mm ²)					
Stranding: 7/30 (7 x 0.25 mm) Insulation thickness: 0.010 (0.25 mm) 22 AWG (0.35 mm ²) drain wire					
Part No.	Pairs	Nominal Diameter		Jacket Thickness	
		Inch	mm	Inch	Mm
M243473	2	0.219	5.56	0.015	0.38
M243103	3	0.227	5.77	0.015	0.38
M243106	6	0.316	8.03	0.020	0.51

20 AWG (0.56 mm ²)					
Stranding: 7/28 (7 x 0.32 mm) Insulation thickness: 0.010 (0.25 mm) 22 AWG (0.35 mm ²) drain wire					
Part No.	Pairs	Nominal Diameter		Jacket Thickness	
		Inch	mm	Inch	Mm
M243142	2	0.241	6.12	0.015	0.38
M243143	3	0.258	6.55	0.015	0.38
M243144	4	0.295	7.49	0.020	0.51

18 AWG (0.89 mm ²)					
Stranding: 7/26 (16 x 0.40 mm) Insulation thickness: 0.010 (0.25 mm) 20 AWG (0.56 mm ²) drain wire					
Part No.	Pairs	Nominal Diameter		Jacket Thickness	
		Inch	mm	Inch	Mm
M243172	2	0.276	7.01	0.015	0.38
M243173	3	0.295	7.49	0.015	0.38



Manhattan™ Plenum Cable

300 V Overall Foil Shield, Multipair, FEP, PVC, Plenum Rated

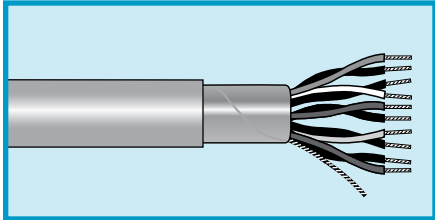

UL CMP
CSA CMP FT6

Operating Temperature

- -20°C to +75°C

Conductor Color Coding

- Chart K (page 529)

Materials

- Stranded tinned copper conductors
- FEP insulation
- Aluminum/polyester foil shield, 25% overlap min.
Foil facing inward
- Stranded tinned copper drain wire (see tables for size)
- Slate plenum-rated PVC jacket

Availability

100 ft (30.5 m)
500 ft (152 m)
1000 ft (305 m)
Bulk, cut to length
(Minimums may apply)

24 AWG (0.22 mm²)

Stranding: 7/32 (7 x 0.20 mm)
Insulation thickness: 0.006 (0.15 mm)
24 AWG (0.22 mm²) drain wire

Part No.	Pairs	Nominal Diameter		Jacket Thickness	
		Inch	mm	Inch	Mm
M52893	1	0.155	3.94	0.015	0.38
M52894	2	0.155	3.94	0.015	0.38
M52895	3	0.164	4.17	0.015	0.38
M52896	4	0.180	4.57	0.015	0.38
M52897	5	0.197	5.00	0.015	0.38
M52898	6	0.215	5.46	0.015	0.38
M52900	9	0.252	6.40	0.015	0.38
M52902	12.5	0.282	7.16	0.015	0.38



Manhattan™ Plenum Cable

300 V Overall Foil Shield, Multipair, FEP, FEP, Plenum Rated

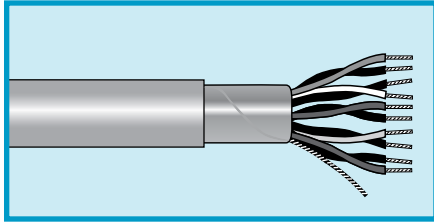

UL CMP
CSA CMP

Operating Temperature

- -80°C to +150°C

Conductor Color Coding

- Chart K (page 529)

Materials

- Stranded bare copper pairs
- FEP insulation
- Aluminum/polyester foil shield,
25% overlap min.
Foil facing inward
- Stranded tinned copper
drain wire sized the same as
conductors
- Red FEP jacket

Availability

100 ft (30.5 m)
500 ft (152 m)
1000 ft (305 m)
Bulk, cut to length
(Minimums may apply)

24 AWG (0.22 mm²)

Stranding: 7/32 (7 x 0.20 mm)
Insulation thickness: 0.006 (0.15 mm)
24 AWG (0.22 mm²) drain wire

Part No.	Pairs	Nominal Diameter		Jacket Thickness	
		Inch	mm	Inch	mm
M613190	1	0.155	3.94	0.015	0.38
M613191	2	0.155	3.94	0.015	0.38
M613192	3	0.164	4.17	0.015	0.38
M613193	4	0.180	4.57	0.015	0.38
M613194	5	0.197	5.00	0.015	0.38



Manhattan™ Plenum Cable

300 V Individually Foil Shielded Pairs, Multipair, FEP, PVDF
Plenum Rated

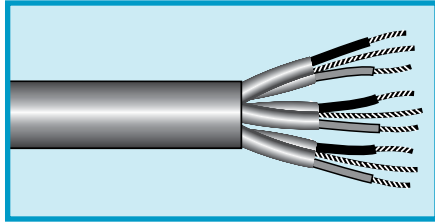

UL CMP
CSA CMP

Operating Temperature

- -20°C to +150°C
- -20°C to +75°C (CMP)

Conductor Color Coding

- Chart M (page 530)

Materials

- Stranded bare copper conductors
- FEP insulation
- Aluminum/polyester foil shield, 25% overlap min.
Foil facing inward
- Stranded tinned copper drain wire sized the same as conductors
- Slate PVDF jacket

Availability

100 ft (30.5 m)
500 ft (152 m)
1000 ft (305 m)
Bulk, cut to length
(Minimums may apply)

24 AWG (0.22 mm²)

Stranding: 7/32 (7 x 0.20 mm)
Insulation thickness: 0.010 (0.25 mm)
24 AWG (0.22 mm²) drain wire

Part No.	Pairs	Nominal Diameter		Jacket Thickness	
		Inch	mm	Inch	Mm
M42891	2	0.192	4.88	0.015	0.38
M42892	3	0.205	5.21	0.015	0.38
M42893	4	0.244	6.20	0.015	0.38
M42894	5	0.250	6.35	0.015	0.38
M42895	6	0.274	6.96	0.015	0.38
M42896	7	0.274	6.96	0.015	0.38
M42897	9	0.325	8.26	0.015	0.38
M42898	12	0.367	9.32	0.015	0.38
M42899	18	0.446	11.33	0.020	0.51



Manhattan™ Control Cable

600 V Braid Shield, Multiconductor, PVC, PVC

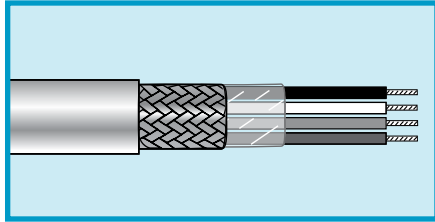

MIL-DTL-16878/1 and /17 Conductors (Types B and B/N) UL VW-1

Operating Temperature

- 55°C to +105°C

Conductor Color Coding

- Chart P (page 535) unless otherwise noted

Materials

- Stranded tinned copper conductors
- PVC or PVC/nylon insulation
- Tinned copper braid shield, 90% coverage
- White PVC jacket

Availability

100 ft (30.5 m)
500 ft (152 m)
1000 ft (305 m)
Bulk, cut to length
(Minimums may apply)

MIL-DTL-16878/1 Conductors

28 AWG (0.09 mm²)

Stranding: 7/36 (7 x 0.13 mm)
Insulation thickness: 0.010 (0.25 mm)

Part No.	Conductors	Nominal Diameter		Jacket Thickness		Color Code
		Inch	mm	Inch	mm	
M1411*	1	0.073	1.85	0.010	0.25	P
M1412	2	0.116	2.95	0.012	0.30	P
M1604	4	0.132	3.35	0.013	0.33	F
M1605	5	0.144	3.66	0.014	0.36	F
M1606	6	0.157	3.99	0.015	0.38	F
M1608	8	0.175	4.45	0.017	0.43	F
M1610	10	0.201	5.11	0.018	0.46	F
M1612	12	0.210	5.33	0.020	0.51	F

*Black jacket. All others slate.

MIL-DTL-16878/17 Conductors

26 AWG (0.14 mm²)

Stranding: 7/34 (7 x 0.16 mm)
Insulation thickness: 0.010 (0.25 mm) PVC/0.003 (0.08 mm) nylon

Part No.	Conductors	Nominal Diameter		Jacket Thickness	
		Inch	mm	Inch	mm
M1421	1	0.083	2.11	0.010	0.25
M1422	2	0.140	3.56	0.014	0.36
M1423	3	0.147	3.73	0.014	0.36

MIL-DTL-16878/17 Conductors

24 AWG (0.24 mm²)

Stranding: 19/36 (19 x 0.13 mm)
Insulation thickness: 0.010 (0.25 mm) PVC/0.003 (0.08 mm) nylon

Part No.	Conductors	Nominal Diameter		Jacket Thickness	
		Inch	mm	Inch	mm
M1431	1	0.093	2.36	0.010	0.25
M1432	2	0.156	3.96	0.016	0.41
M1433	3	0.164	4.17	0.016	0.41



Manhattan™ Control Cable

600 V Braid Shield, Multiconductor, PVC, PVC

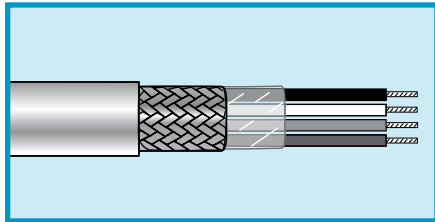

MIL-DTL-16878/1 and /17 Conductors (Types B and B/N) UL VW-1

Operating Temperature

- 55°C to +105°C

Conductor Color Coding

- Chart P (page 535) unless otherwise noted

Materials

- Stranded tinned copper conductors
- PVC or PVC/nylon insulation
- Tinned copper braid shield, 90% coverage
- White PVC jacket

Availability

100 ft (30.5 m)
500 ft (152 m)
1000 ft (305 m)
Bulk, cut to length
(Minimums may apply)

MIL-DTL-16878/17 Conductors

22 AWG (0.38 mm²)

Stranding: 19/34 (19 x 0.16 mm)
Insulation thickness: 0.010 (0.25 mm) PVC/0.003 (0.08 mm) nylon

Part No.	Conductors	Nominal Diameter		Jacket Thickness		Color Code
		Inch	mm	Inch	mm	
M1441	1	0.100	2.54	0.010	0.25	P
M1442	2	0.178	4.52	0.020	0.51	P
M1443	3	0.187	4.75	0.020	0.51	P
M1444	4	0.202	5.13	0.020	0.51	P
M1644	4	0.203	5.16	0.019	0.48	F
M1645	5	0.222	5.64	0.020	0.51	F
M1646	6	0.240	6.10	0.020	0.51	F
M1648	8	0.268	6.81	0.025	0.64	F
M1650*	10	0.309	7.85	0.026	0.66	F

*Black jacket. All others slate.

MIL-DTL-16878/17 Conductors

20 AWG (0.62 mm²)

Stranding: 19/32 (19 x 0.20 mm)
Insulation thickness: 0.010 (0.25 mm) PVC/0.003 (0.08 mm) nylon

Part No.	Conductors	Nominal Diameter		Jacket Thickness	
		Inch	mm	Inch	mm
M1451	1	0.108	2.74	0.010	0.25
M1452	2	0.194	4.93	0.020	0.51
M1453	3	0.214	5.44	0.025	0.64
M1454	4	0.232	5.89	0.025	0.64

MIL-DTL-16878/17 Conductors

18 AWG (0.96 mm²)

Stranding: 19/30 (19 x 0.25 mm)
Insulation thickness: 0.010 (0.25 mm) PVC/0.003 (0.08 mm) nylon

Part No.	Conductors	Nominal Diameter		Jacket Thickness	
		Inch	mm	Inch	mm
M1461	1	0.122	3.10	0.012	0.30
M1462	2	0.216	5.49	0.021	0.53
M1463	3	0.230	5.84	0.022	0.56

MIL-DTL-16878/17 Conductors

16 AWG (1.23 mm²)

Stranding: 19/29 (19 x 0.29 mm)
Insulation thickness: 0.011 (0.28 mm) PVC/0.004 (0.10 mm) nylon

Part No.	Conductors	Nominal Diameter		Jacket Thickness	
		Inch	mm	Inch	mm
M1471	1	0.144	3.66	0.018	0.46
M1472	2	0.240	6.10	0.023	0.58
M1473	3	0.257	6.53	0.025	0.64
M1474	4	0.280	7.11	0.025	0.64



Manhattan™ Control Cable

1000 V Braid Shield, Multiconductor, PVC, PVC

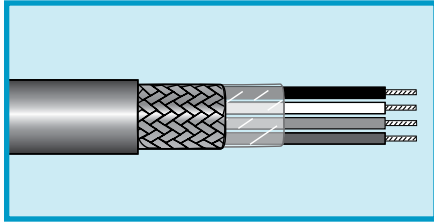

MIL-DTL-16878/2 and /18 Conductors (Types C and C/N) UL VW-1

Operating Temperature

- -55°C to +105°C

Conductor Color Coding

- Chart F (page 532)

Materials

- Stranded tinned copper conductors
- PVC or PVC/nylon insulation
- Tinned copper braid shield, 90% coverage
- Slate PVC jacket

Availability

100 ft (30.5 m)
500 ft (152 m)
1000 ft (305 m)
Bulk, cut to length
(Minimums may apply)

MIL-DTL-16878/2 Conductors

18 AWG (0.96 mm²)

Stranding: 19/30 (19 x 0.25 mm)
Insulation thickness: 0.016 (0.41 mm)

Part No.	Conductors	Nominal Diameter		Jacket Thickness	
		Inch	mm	Inch	mm
M1704	4	0.269	6.83	0.023	0.58
M1705	5	0.297	7.54	0.025	0.64
M1706	6	0.332	8.43	0.030	0.76
M1708	8	0.362	9.19	0.032	0.81
M1710	10	0.423	10.74	0.035	0.89
M1712	12	0.442	11.23	0.035	0.89
M1714	14	0.473	12.01	0.040	1.02
M1716	16	0.509	12.93	0.046	1.17

MIL-DTL-16878/18 Conductors

16 AWG (1.23 mm²)

Stranding: 19/29 (19 x 0.29 mm)
Insulation thickness: 0.017 (0.43 mm) PVC/0.004 (0.10 mm) nylon

Part No.	Conductors	Nominal Diameter		Jacket Thickness	
		Inch	mm	Inch	mm
M1764	4	0.324	8.23	0.031	0.79
M1765	5	0.357	9.07	0.033	0.84
M1766	6	0.390	9.91	0.035	0.89
M1768	8	0.431	10.95	0.040	1.02
M1772	12	0.532	13.51	0.047	1.19
M1776	16	0.598	15.19	0.053	1.35
M1779	19	0.636	16.15	0.057	1.45
M1787	27	0.768	19.51	0.067	1.70

Manhattan™ Control Cable

600 V Unshielded, Multiconductor, PVC/Nylon, PVC

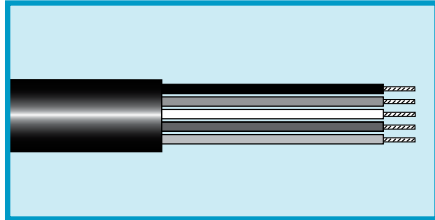

UL TC

Operating Temperature

- -25°C to +90°C

Conductor Color Coding

- Chart J (page 533)

Materials

- Stranded bare copper conductors
- PVC/nylon insulation
- Black PVC jacket

Features

- UL Sunlight Resistant
- UL Direct Burial

Availability

100 ft (30.5 m)
 500 ft (152 m)
 1000 ft (305 m)
 Bulk, cut to length
 (Minimums may apply)

18 AWG (0.82 mm²)

Stranding: 7/0.0152 (7 x 0.39 mm)
 Insulation thickness: 0.016 (0.41 mm) PVC/0.005 (0.13 mm) nylon

Part No.	Conductors	Nominal Diameter		Jacket Thickness	
		Inch	mm	Inch	mm
M3800	2	0.185 x 0.273	4.70 x 6.93	0.047	1.19
M3801	3	0.287	7.29	0.047	1.19
M3802	4	0.310	7.87	0.047	1.19
M3803	5	0.336	8.53	0.047	1.19
M3804	6	0.362	9.19	0.047	1.19
M3805	7	0.362	9.19	0.047	1.19
M3806	8	0.390	9.91	0.047	1.19
M3807	9	0.417	10.59	0.047	1.19
M3808	10	0.449	11.40	0.047	1.19
M3810	12	0.463	11.76	0.047	1.19
M3815	15	0.533	13.54	0.063	1.60
M3819	19	0.569	14.45	0.063	1.60
M3822	24	0.646	16.41	0.063	1.60
M3821	25	0.657	16.69	0.063	1.60
M3823	30	0.694	17.63	0.063	1.60
M3825	37	0.745	18.92	0.063	1.60

16 AWG (1.31 mm²)

Stranding: 7/0.0192 (7 x 0.49 mm)
 Insulation thickness: 0.016 (0.41 mm) PVC/0.005 (0.13 mm) nylon

Part No.	Conductors	Nominal Diameter		Jacket Thickness	
		Inch	mm	Inch	mm
M3826	2	0.197 x 0.297	5.00 x 7.54	0.047	1.19
M3828	3	0.310	7.87	0.047	1.19
M3829	4	0.339	8.61	0.047	1.19
M3830	5	0.368	9.35	0.047	1.19
M3831	6	0.398	10.11	0.047	1.19
M3832	7	0.398	10.11	0.047	1.19
M3833	8	0.429	10.90	0.047	1.19
M3834	9	0.461	11.71	0.047	1.19
M3835	10	0.497	12.62	0.047	1.19
M3837	12	0.545	13.84	0.063	1.60
M3838	15	0.588	14.94	0.063	1.60
M3839	19	0.630	16.00	0.063	1.60
M3840	24	0.717	18.21	0.063	1.60
M3843	25	0.729	18.52	0.063	1.60
M3841	30	0.770	19.56	0.063	1.60
M3842	37	0.869	22.07	0.083	2.11



Manhattan™ Control Cable

600 V Unshielded, Multiconductor, PVC/Nylon, PVC

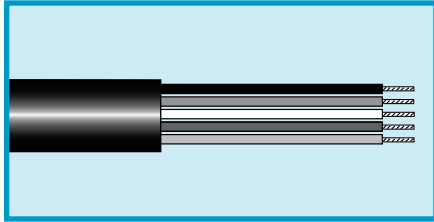

UL TC

Operating Temperature

- 25°C to +90°C

Conductor Color Coding

- Chart J (page 533)

Materials

- Stranded bare copper conductors
- PVC/nylon insulation
- Black PVC jacket

Features

- UL Sunlight Resistant
- UL Direct Burial

Availability

100 ft (30.5 m)
 500 ft (152 m)
 1000 ft (305 m)
 Bulk, cut to length
 (Minimums may apply)

14 AWG (2.08 mm²)

Stranding: 7/0.0242 (7 x 0.62 mm)
 Insulation thickness: 0.016 (0.41 mm) PVC/0.005 (0.13 mm) nylon

Part No.	Conductors	Nominal Diameter		Jacket Thickness	
		Inch	mm	Inch	mm
M3845	2	0.212 x 0.32	5.38 x 8.31	0.047	1.19
M3847	3	0.345	8.76	0.047	1.19
M3848	4	0.375	9.53	0.047	1.19
M3849	5	0.409	10.39	0.047	1.19
M3850	6	0.444	11.28	0.047	1.19
M3851	7	0.444	11.28	0.047	1.19
M3852	8	0.479	12.17	0.047	1.19
M3853	9	0.547	13.89	0.063	1.60
M3854	10	0.589	14.96	0.063	1.60
M3856	12	0.607	15.42	0.063	1.60
M3857	15	0.657	16.69	0.063	1.60
M3858	19	0.705	17.91	0.063	1.60
M3859	24	0.805	20.45	0.063	1.60
M3862	25	0.859	21.82	0.083	2.11
M3860	30	0.907	23.04	0.083	2.11
M3861	37	0.974	24.74	0.083	2.11

12 AWG (3.30 mm²)

Stranding: 7/0.0305 (7 x 0.78 mm)
 Insulation thickness: 0.016 (0.41 mm) PVC/0.005 (0.13 mm) nylon

Part No.	Conductors	Nominal Diameter		Jacket Thickness	
		Inch	mm	Inch	mm
M3865	2	0.231 x 0.365	5.87 x 9.27	0.047	1.19
M3867	3	0.386	9.80	0.047	1.19
M3868	4	0.421	10.69	0.047	1.19
M3869	5	0.460	11.68	0.047	1.19
M3870	6	0.501	12.73	0.047	1.19
M3871	7	0.501	12.73	0.047	1.19
M3872	8	0.575	14.61	0.063	1.60
M3873	9	0.617	15.67	0.063	1.60
M3874	10	0.665	16.89	0.063	1.60
M3876	12	0.686	17.42	0.063	1.60
M3877	15	0.744	18.90	0.063	1.60
M3878	16	0.759	19.28	0.063	1.60
M3879	19	0.800	20.32	0.063	1.60
M3880	24	0.957	24.31	0.083	2.11
M3883	25	0.973	24.71	0.083	2.11
M3881	30	1.029	26.14	0.083	2.11
M3882	37	1.107	28.12	0.083	2.11



Manhattan™ Control Cable

600 V Unshielded, Multiconductor, PVC/Nylon, PVC

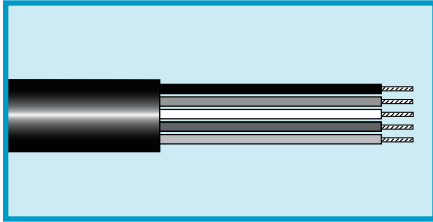

10 AWG (5.26 mm²)

Stranding: 7/0.0385 (7 x 0.98 mm)
 Insulation thickness: 0.022 (0.56 mm) PVC/0.005 (0.13 mm) nylon

Part No.	Conductors	Nominal Diameter		Jacket Thickness	
		Inch	mm	Inch	mm
M3902	2	0.267 x 0.365	6.78 x 9.27	0.047	1.19
M3903	3	0.464	11.79	0.047	1.19
M3904	4	0.540	13.72	0.063	1.60
M3905	5	0.590	14.99	0.063	1.60
M3906	6	0.641	16.28	0.063	1.60
M3907	7	0.641	16.28	0.063	1.60
M3908	8	0.694	17.63	0.063	1.60
M3910	9	0.748	19.00	0.063	1.60
M3911	10	0.809	20.55	0.063	1.60
M3913	12	0.875	22.23	0.083	2.11
M3915	14	0.920	23.37	0.083	2.11
M3916	15	0.950	24.13	0.083	2.11

UL TC

Operating Temperature

- -25°C to +90°C

Conductor Color Coding

- Chart J (page 533)

Materials

- Stranded bare copper conductors
- PVC/nylon insulation
- Black PVC jacket

Features

- UL Sunlight Resistant
- UL Direct Burial

Availability

100 ft (30.5 m)

500 ft (152 m)

1000 ft (305 m)

Bulk, cut to length

(Minimums may apply)



Manhattan™ Control Cable

600 V Unshielded, Multiconductor, PVC/Nylon, PVC

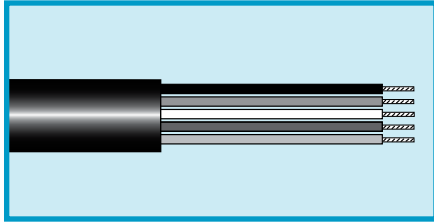

UL TC

Operating Temperature

- 25°C to +90°C

Conductor Color Coding

- Chart D (page 531)

Materials

- Stranded tinned copper conductors
- PVC/nylon insulation
- Black PVC jacket

Features

- UL Sunlight Resistant
- UL Direct Burial

Availability

100 ft (30.5 m)

500 ft (152 m)

1000 ft (305 m)

Bulk, cut to length
(Minimums may apply)

18 AWG (0.96 mm²)

Stranding: 19/30 (19 x 0.25 mm)
Insulation thickness: 0.016 (0.41 mm) PVC/0.005 (0.13 mm) nylon

Part No.	Conductors	Nominal Diameter		Jacket Thickness	
		Inch	mm	Inch	mm
M39056	2	0.283	7.19	0.048	1.22

16 AWG (1.32 mm²)

Stranding: 19/0.0117 (19 x 0.30 mm)
Insulation thickness: 0.016 (0.41 mm) PVC/0.005 (0.13 mm) nylon

Part No.	Conductors	Nominal Diameter		Jacket Thickness	
		Inch	mm	Inch	mm
M39057	2	0.301	7.65	0.048	1.22

14 AWG (2.08 mm²)

Stranding: 41/30 (41 x 0.25 mm)
Insulation thickness: 0.022 (0.56 mm) PVC/0.005 (0.13 mm) nylon

Part No.	Conductors	Nominal Diameter		Jacket Thickness	
		Inch	mm	Inch	mm
M39058	2	0.355	9.02	0.048	1.22

12 AWG (3.29 mm²)

Stranding: 65/30 (65 x 0.25 mm)
Insulation thickness: 0.022 (0.56 mm) PVC/0.005 (0.13 mm) nylon

Part No.	Conductors	Nominal Diameter		Jacket Thickness	
		Inch	mm	Inch	mm
M39059	2	0.393	9.98	0.048	1.22

Manhattan™ Control Cable

600 V Foil Shield, Multiconductor, PVC/Nylon, PVC

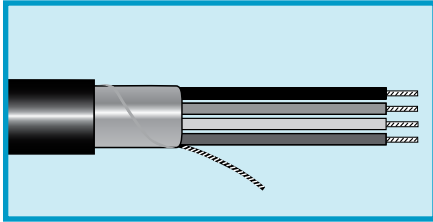

UL TC

Operating Temperature

- -25°C to +90°C

Conductor Color Coding

- Chart J (page 533)

Materials

- Stranded bare copper conductors
- PVC/nylon insulation
- Aluminum/polyester foil shield, 25% overlap min.
Foil facing inward
- Stranded tinned copper drain wire one even AWG size smaller than conductor
- Black PVC jacket

Features

- UL Sunlight Resistant
- UL Direct Burial

Availability

100 ft (30.5 m)
500 ft (152 m)
1000 ft (305 m)
Bulk, cut to length
(Minimums may apply)

18 AWG (0.82 mm²)

Stranding: 7/0.0152 (7 x 0.39 mm)
Insulation thickness: 0.016 (0.41 mm) PVC/0.005 (0.13 mm) nylon

Part No.	Conductors	Nominal Diameter		Jacket Thickness	
		Inch	mm	Inch	mm
M33800	2	0.277	7.04	0.047	1.19
M33801	3	0.291	7.39	0.047	1.19
M33802	4	0.314	7.98	0.047	1.19
M33803	5	0.340	8.64	0.047	1.19
M33805	7	0.366	9.30	0.047	1.19
M33807	9	0.421	10.69	0.047	1.19
M33810	12	0.467	11.86	0.047	1.19
M33815	15	0.537	13.64	0.063	1.60
M33819	19	0.573	14.55	0.063	1.60

16 AWG (1.31 mm²)

Stranding: 7/0.0192 (7 x 0.49 mm)
Insulation thickness: 0.016 (0.41 mm) PVC/0.005 (0.13 mm) nylon

Part No.	Conductors	Nominal Diameter		Jacket Thickness	
		Inch	mm	Inch	mm
M33826	2	0.301	7.65	0.047	1.19
M33828	3	0.317	8.05	0.047	1.19
M33829	4	0.343	8.71	0.047	1.19
M33830	5	0.372	9.45	0.047	1.19
M33832	7	0.402	10.21	0.047	1.19
M33834	9	0.465	11.81	0.047	1.19
M33837	12	0.549	13.94	0.063	1.60
M33838	15	0.592	15.04	0.063	1.60
M33839	19	0.634	16.10	0.063	1.60

14 AWG (2.08 mm²)

Stranding: 7/0.0242 (7 x 0.62 mm)
Insulation thickness: 0.016 (0.41 mm) PVC/0.005 (0.13 mm) nylon

Part No.	Conductors	Nominal Diameter		Jacket Thickness	
		Inch	mm	Inch	mm
M33845	2	0.331	8.41	0.047	1.19
M33847	3	0.349	8.86	0.047	1.19
M33848	4	0.379	9.63	0.047	1.19
M33849	5	0.413	10.49	0.047	1.19
M33851	7	0.448	11.38	0.047	1.19
M33853	9	0.551	14.00	0.063	1.60
M33856	12	0.611	15.52	0.063	1.60
M33857	15	0.661	16.79	0.063	1.60
M33858	19	0.709	18.01	0.063	1.60



Manhattan™ Control Cable

600 V Foil Shield, Multiconductor, PVC/Nylon, PVC

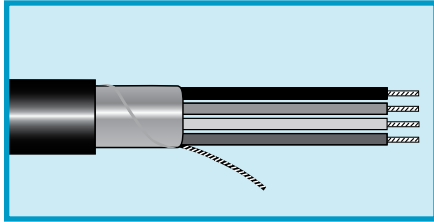

UL TC

Operating Temperature

- 25°C to +90°C

Conductor Color Coding

- Chart J (page 533)

Materials

- Stranded bare copper conductors
- PVC/nylon insulation
- Aluminum/polyester foil shield, 25% overlap min. Foil facing inward
- Stranded tinned copper drain wire one even AWG size smaller than conductor
- Black PVC jacket

Features

- UL Sunlight Resistant
- UL Direct Burial

Availability

100 ft (30.5 m)
 500 ft (152 m)
 1000 ft (305 m)
 Bulk, cut to length
 (Minimums may apply)

12 AWG (3.30 mm²)

Stranding: 7/0.0305 (7 x 0.78 mm)
 Insulation thickness: 0.016 (0.41 mm) PVC/0.005 (0.13 mm) nylon

Part No.	Conductors	Nominal Diameter		Jacket Thickness	
		Inch	mm	Inch	mm
M33865	2	0.369	9.37	0.047	1.19
M33867	3	0.390	9.91	0.047	1.19
M33868	4	0.425	10.80	0.047	1.19
M33869	5	0.464	11.79	0.047	1.19
M33870	6	0.505	12.83	0.047	1.19
M33871	7	0.505	12.83	0.047	1.19
M33873	9	0.621	15.77	0.063	1.60
M33876	12	0.690	17.53	0.063	1.60
M33877	15	0.748	19.00	0.063	1.60
M33879	19	0.804	20.42	0.063	1.60

10 AWG (5.26 mm²)

Stranding: 7/0.0385 (7 x 0.98 mm)
 Insulation thickness: 0.022 (0.56 mm) PVC/0.005 (0.13 mm) nylon

Part No.	Conductors	Nominal Diameter		Jacket Thickness	
		Inch	mm	Inch	mm
M33902	2	0.441	11.20	0.047	1.19
M33903	3	0.468	11.89	0.047	1.19
M33904	4	0.544	13.82	0.063	1.60
M33905	5	0.594	15.09	0.063	1.60
M33906	6	0.645	16.38	0.063	1.60
M33907	7	0.645	16.38	0.063	1.60
M33910	9	0.752	19.10	0.063	1.60
M33912	12	0.879	22.33	0.083	2.11



Manhattan™ Control Cable

600 V Foil Shield, Multiconductor, PVC/Nylon, PVC

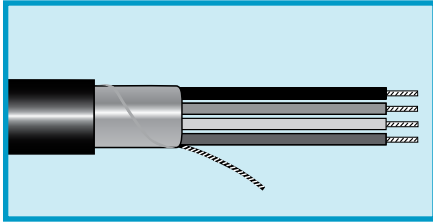

UL TC

Operating Temperature

- 25°C to +90°C

Conductor Color Coding

- Chart D (page 531)

Materials

- Stranded bare copper conductors
- PVC/nylon insulation
- Aluminum/polyester foil shield, 25% overlap min. Foil facing inward
- Stranded tinned copper drain wire one even AWG size smaller than conductor
- Black PVC jacket

Features

- UL Sunlight Resistant
- UL Direct Burial

Availability

100 ft (30.5 m)
 500 ft (152 m)
 1000 ft (305 m)
 Bulk, cut to length
 (Minimums may apply)

18 AWG (0.96 mm ²)					
Stranding: 19/30 (19 x 0.25 mm)					
Insulation thickness: 0.016 (0.41 mm) PVC/0.005 (0.13 mm) nylon					
Part No.	Conductors	Nominal Diameter		Jacket Thickness	
		Inch	mm	Inch	mm
M39109	2	0.287	7.29	0.048	1.22

16 AWG (1.32 mm ²)					
Stranding: 19/0.0117 (19 x 0.30 mm)					
Insulation thickness: 0.016 (0.41 mm) PVC/0.005 (0.13 mm) nylon					
Part No.	Conductors	Nominal Diameter		Jacket Thickness	
		Inch	mm	Inch	mm
M39110	2	0.305	7.75	0.048	1.22

14 AWG (2.08 mm ²)					
Stranding: 41/30 (41 x 0.25 mm)					
Insulation thickness: 0.022 (0.56 mm) PVC/0.005 (0.13 mm) nylon					
Part No.	Conductors	Nominal Diameter		Jacket Thickness	
		Inch	mm	Inch	mm
M39111	2	0.359	9.11	0.048	1.22

12 AWG (3.29 mm ²)					
Stranding: 65/30 (65 x 0.25 mm)					
Insulation thickness: 0.022 (0.56 mm) PVC/0.005 (0.13 mm) nylon					
Part No.	Conductors	Nominal Diameter		Jacket Thickness	
		Inch	mm	Inch	mm
M39112	2	0.397	10.08	0.048	1.22



Manhattan™ Control Cable

600 V Foil Shield, Multiconductor, PVC/Nylon, PVC

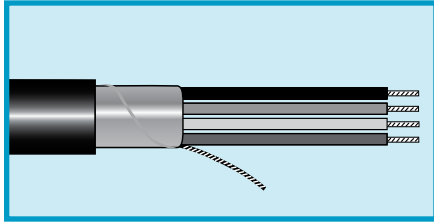

UL TC

Operating Temperature

- 25°C to +90°C

Conductor Color Coding

- Chart J1 (page 533)

Materials

- Stranded bare copper conductors
- PVC/nylon insulation
- Aluminum/polyester foil shield, 25% overlap min. Foil facing inward
- Stranded tinned copper drain wire equal in size to conductors
- Black PVC jacket

Features

- UL Sunlight Resistant
- UL Direct Burial

Availability

Bulk, cut to length
(Minimums may apply)

16 AWG (1.31 mm²)

Stranding: 7/0.0192 (7 x 0.49 mm)
Insulation thickness: 0.016 (0.41 mm) PVC/0.005 (0.13 mm) nylon

Part No.	Conductors	Nominal Diameter		Jacket Thickness	
		Inch	mm	Inch	mm
7616/6	6	0.401	10.19	0.048	1.22

14 AWG (2.08 mm²)

Stranding: 7/0.0242 (41 x 0.62 mm)
Insulation thickness: 0.016 (0.41 mm) PVC/0.005 (0.13 mm) nylon

Part No.	Conductors	Nominal Diameter		Jacket Thickness	
		Inch	mm	Inch	mm
7614/6	6	0.447	11.35	0.048	1.22



Manhattan™ Control Cable

300 V Unshielded, Multiconductor, PVC, PVC

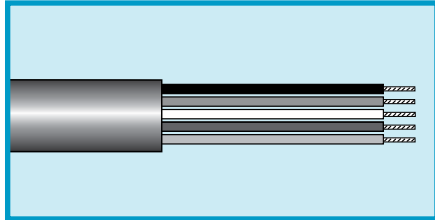

UL PLTC, ITC
UL CMG
CSA CMG FT4

Operating Temperature

- -20°C to +105°C

Conductor Color Coding

- Chart D (page 531)

Materials

- Stranded tinned copper conductors
- PVC insulation
- Slate PVC jacket

Features

- UL Sunlight Resistant

Availability

100 ft (30.5 m)
 500 ft (152 m)
 1000 ft (305 m)
 Bulk, cut to length
 (Minimums may apply)

22 AWG (0.35 mm²)

Stranding: 7/30 (7 x 0.25 mm)
 Insulation thickness: 0.016 (0.41 mm)

Part No.	Conductors	Nominal Diameter		Jacket Thickness	
		Inch	mm	Inch	mm
M39071	2	0.203	5.16	0.038	0.97
M39072	3	0.213	5.41	0.038	0.97

20 AWG (0.61 mm²)

Stranding: 19/32 (19 x 0.20 mm)
 Insulation thickness: 0.016 (0.41 mm)

Part No.	Conductors	Nominal Diameter		Jacket Thickness	
		Inch	mm	Inch	mm
M39073	2	0.223	5.66	0.038	0.97
M39074	3	0.234	5.94	0.038	0.97

18 AWG (0.96 mm²)

Stranding: 19/30 (19 x 0.25 mm)
 Insulation thickness: 0.016 (0.41 mm)

Part No.	Conductors	Nominal Diameter		Jacket Thickness	
		Inch	mm	Inch	mm
M39075	2	0.243	6.17	0.038	0.97
M39076	3	0.256	6.50	0.038	0.97

16 AWG (1.32 mm²)

Stranding: 19/0.0117 (7 x 0.30 mm)
 Insulation thickness: 0.016 (0.41 mm)

Part No.	Conductors	Nominal Diameter		Jacket Thickness	
		Inch	mm	Inch	mm
M39077	2	0.261	6.63	0.038	0.97
M39078	3	0.275	6.99	0.038	0.97

14 AWG (2.08 mm²)

Stranding: 41/30 (41 x 0.25 mm)
 Insulation thickness: 0.022 (0.56 mm)

Part No.	Conductors	Nominal Diameter		Jacket Thickness	
		Inch	mm	Inch	mm
M39079*	2	0.325	8.26	0.043	1.09
M39080*	3	0.343	8.71	0.043	1.09

*Not CMG approved.

12 AWG (3.29 mm²)

Stranding: 65/30 (65 x 0.25 mm)
 Insulation thickness: 0.032 (0.81 mm)

Part No.	Conductors	Nominal Diameter		Jacket Thickness	
		Inch	mm	Inch	mm
M39081*	2	0.423	10.74	0.053	1.35

*Not CMG approved.



Manhattan™ Control Cable

300 V Foil Shield, Individual Pairs, Multipair, PVC, PVC

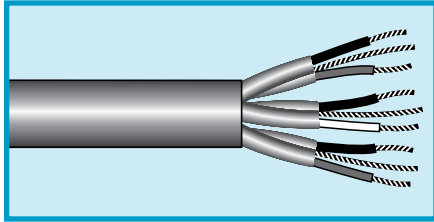

UL PLTC, ITC
UL CMG
CSA CMG

Operating Temperature

- -20°C to +105°C

Conductor Color Coding

- Chart BR (page 529)

Materials

- Stranded tinned copper conductors
- PVC insulation
- Aluminum/polyester foil shield, 25% overlap min.
Foil facing inward
- Stranded tinned copper drain wire one even AWG size smaller than conductor
- Slate PVC jacket

Features

- UL Sunlight Resistant

Availability

100 ft (30.5 m)
 500 ft (152 m)
 1000 ft (305 m)
 Bulk, cut to length
 (Minimums may apply)

22 AWG (0.35 mm²)

Stranding: 7/30 (7 x 0.25 mm)
 Insulation thickness: 0.016 (0.41 mm)

Part No.	Pairs	Nominal Diameter		Jacket Thickness	
		Inch	mm	Inch	mm
M39147	2	0.320	8.13	0.043	1.09
M39148	3	0.338	8.59	0.043	1.09
M39149	4	0.368	9.35	0.043	1.09
M39150	6	0.457	11.61	0.053	1.35
M39151	9	0.529	13.44	0.053	1.35
M39152	11	0.563	14.30	0.053	1.35
M39153	15	0.582	14.78	0.053	1.35
M39154	19	0.646	16.41	0.063	1.60
M39155	27	0.763	19.38	0.063	1.60
M39156	51	1.005	25.53	0.075	1.91

18 AWG (0.96 mm²)

Stranding: 19/30 (19 x 0.25 mm)
 Insulation thickness: 0.016 (0.41 mm)

Part No.	Pairs	Nominal Diameter		Jacket Thickness	
		Inch	mm	Inch	mm
M39157	2	0.410	10.41	0.053	1.35
M39158	3	0.434	11.02	0.053	1.35
M39159	4	0.473	12.01	0.053	1.35
M39160	6	0.563	14.30	0.053	1.35
M39161	9	0.677	17.20	0.063	1.60
M39162	11	0.731	18.57	0.063	1.60
M39163	15	0.820	20.83	0.063	1.60



Manhattan™ Control Cable

300 V Overall Foil Shield, Multipair, PVC, PVC

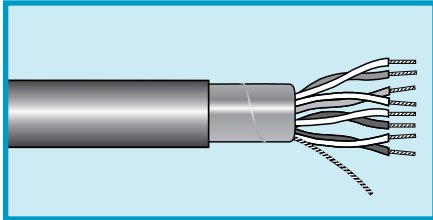

UL PLTC, ITC
UL CMG
CSA CMG

Operating Temperature

- -20°C to +105°C

Conductor Color Coding

- Chart BR (page 529)

Materials

- Stranded tinned copper conductors
- PVC insulation
- Aluminum/polyester foil shield, 25% overlap min.
Foil facing inward
Stranded tinned copper drain wire one even AWG size smaller than conductor
- Slate PVC jacket

Features

- UL Sunlight Resistant

Availability

100 ft (30.5 m)
 500 ft (152 m)
 1000 ft (305 m)
 Bulk, cut to length
 (Minimums may apply)

22 AWG (0.35 mm²)

Stranding: 7/30 (7 x 0.25 mm)
 Insulation thickness: 0.016 (0.41 mm)

Part No.	Pairs	Nominal Diameter		Jacket Thickness	
		Inch	mm	Inch	mm
M39130	2	0.296	7.52	0.043	1.09
M39131	3	0.312	7.92	0.043	1.09
M39132	4	0.339	8.61	0.043	1.09
M39133	6	0.420	10.67	0.053	1.35
M39134	9	0.483	12.27	0.053	1.35
M39135	11	0.520	13.21	0.053	1.35
M39136	15	0.580	14.73	0.053	1.35
M39137	19	0.642	16.31	0.063	1.60
M39138	27	0.759	19.28	0.063	1.60
M39139	51	0.995	25.27	0.075	1.91

18 AWG (0.96 mm²)

Stranding: 19/30 (19 x 0.25 mm)
 Insulation thickness: 0.016 (0.41 mm)

Part No.	Pairs	Nominal Diameter		Jacket Thickness	
		Inch	mm	Inch	mm
M39140	2	0.362	9.19	0.043	1.09
M39141	3	0.403	10.24	0.053	1.35
M39142	4	0.438	11.13	0.053	1.35
M39143	6	0.518	13.16	0.053	1.35
M39144	9	0.622	15.80	0.063	1.60
M39145	11	0.671	17.04	0.063	1.60
M39146	15	0.751	19.08	0.063	1.60



Manhattan™ Control Cable

300 V Overall Foil Shield, Multiconductor, PVC, PVC

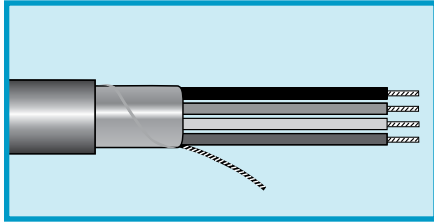

UL PLTC, ITC
UL CMG
CSA CMG FT4

Operating Temperature

- 20°C to +105°C

Conductor Color Coding

- Chart D (page 531)

Materials

- Stranded tinned copper conductors
- PVC insulation
- Aluminum/polyester tape shield, 25% overlap min. Foil facing inward
- Stranded tinned copper drain wire one even AWG size smaller than conductor
- Slate PVC jacket

Features

- UL Sunlight Resistant

Availability

100 ft (30.5 m)
500 ft (152 m)
1000 ft (305 m)
Bulk, cut to length
(Minimums may apply)



22 AWG (0.35 mm²)

Stranding: 7/30 (7 x 0.25 mm)
Insulation thickness: 0.016 (0.41 mm)

Part No.	Conductors	Nominal Diameter		Jacket Thickness	
		Inch	mm	Inch	mm
M39113	2	0.207	5.26	0.038	0.97
M39114	3	0.214	5.44	0.038	0.97

20 AWG (0.61 mm²)

Stranding: 19/32 (19 x 0.20 mm)
Insulation thickness: 0.016 (0.41 mm)

Part No.	Conductors	Nominal Diameter		Jacket Thickness	
		Inch	mm	Inch	mm
M39115	2	0.227	5.77	0.038	0.97
M39116	3	0.238	6.05	0.038	0.97

18 AWG (0.96 mm²)

Stranding: 19/30 (19 x 0.25 mm)
Insulation thickness: 0.016 (0.41 mm)

Part No.	Conductors	Nominal Diameter		Jacket Thickness	
		Inch	mm	Inch	mm
M39117	2	0.247	6.27	0.038	0.97
M39118	3	0.260	6.60	0.038	0.97

16 AWG (1.32 mm²)

Stranding: 19/0.017 (7 x 0.30 mm)
Insulation thickness: 0.016 (0.41 mm)

Part No.	Conductors	Nominal Diameter		Jacket Thickness	
		Inch	mm	Inch	mm
M39119	2	0.265	6.73	0.038	0.97
M39120	3	0.279	7.09	0.038	0.97

14 AWG (2.08 mm²)

Stranding: 41/30 (41 x 0.25 mm)
Insulation thickness: 0.022 (0.56 mm)

Part No.	Conductors	Nominal Diameter		Jacket Thickness	
		Inch	mm	Inch	mm
M39121*	2	0.329	8.36	0.043	1.09
M39122*	3	0.347	8.81	0.043	1.09

*Not CMG approved.

12 AWG (3.29 mm²)

Stranding: 65/30 (65 x 0.25 mm)
Insulation thickness: 0.032 (0.41 mm)

Part No.	Conductors	Nominal Diameter		Jacket Thickness	
		Inch	mm	Inch	mm
M39123*	2	0.427	10.85	0.053	1.35

*Not CMG approved.

Manhattan™ Instrumentation Cable

300 V Unshielded Pairs, PVC, PVC

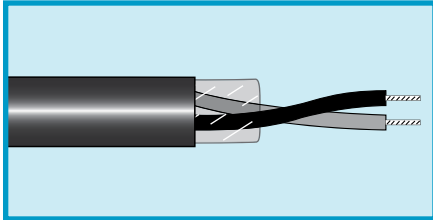

**UL PLTC, ITC
UL CL3
CSA CMG FT4**

Operating Temperature

- -20°C to +105°C

Conductor Color Coding

- Black, white

Materials

- Stranded bare copper conductors
- PVC insulation
- Black PVC jacket

Features

- UL Sunlight Resistant

Availability

100 ft (30.5 m)
500 ft (152 m)
1000 ft (305 m)
Bulk, cut to length
(Minimums may apply)

20 AWG (0.52 mm ²)					
Stranding: 7/0.0121 (7 x 0.31 mm) Insulation thickness: 0.016 (0.41 mm)					
Part No.	Pairs	Nominal Diameter		Jacket Thickness	
		Inch	mm	Inch	mm
M9500010	1	0.215	5.46	0.038	0.97

18 AWG (0.82 mm ²)					
Stranding: 7/0.0152 (7 x 0.39 mm) Insulation thickness: 0.016 (0.41 mm)					
Part No.	Pairs	Nominal Diameter		Jacket Thickness	
		Inch	mm	Inch	mm
M9508010	1	0.235	5.97	0.038	0.97

16 AWG (1.31 mm ²)					
Stranding: 7/0.0192 (7 x 0.49 mm) Insulation thickness: 0.016 (0.41 mm)					
Part No.	Pairs	Nominal Diameter		Jacket Thickness	
		Inch	mm	Inch	mm
M9506010	1	0.259	6.58	0.038	0.97



Manhattan™ Instrumentation Cable

300 V Overall Foil Shield, Pair, PVC, PVC

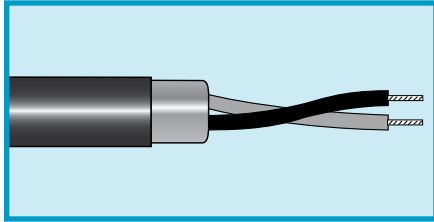

UL PLTC, ITC
UL CL3
CSA CMG FT4

Operating Temperature

- -20°C to +105°C

Conductor Color Coding

- Black, white

Materials

- Stranded bare copper conductors
- PVC insulation
- Aluminum/polyester foil shield, 25% overlap min.
Foil facing inward
- Stranded tinned copper drain wire one even AWG smaller than conductor
- Black PVC jacket

Features

- UL Sunlight Resistant

Availability

100 ft (30.5 m)
 500 ft (152 m)
 1000 ft (305 m)
 Bulk, cut to length
 (Minimums may apply)



22 AWG (0.35 mm²)

Stranding: 7/30 (7 x 0.25 mm)
 Insulation thickness: 0.013 (0.33 mm)
 22 AWG (0.35 mm²) drain wire

Part No.	Pairs	Nominal Diameter		Jacket Thickness	
		Inch	mm	Inch	mm
5610B2201	1	0.192	4.88	0.038	0.97

20 AWG (0.52 mm²)

Stranding: 7/0.0121 (7 x 0.31 mm)
 Insulation thickness: 0.016 (0.41 mm)

Part No.	Pairs	Nominal Diameter		Jacket Thickness	
		Inch	mm	Inch	mm
M9520010	1	0.219	5.56	0.038	0.97

18 AWG (0.82 mm²)

Stranding: 7/0.0152 (7 x 0.39 mm)
 Insulation thickness: 0.016 (0.41 mm)

Part No.	Pairs	Nominal Diameter		Jacket Thickness	
		Inch	mm	Inch	mm
M9528010	1	0.239	6.07	0.038	0.97

16 AWG (1.31 mm²)

Stranding: 7/0.0192 (7 x 0.49 mm)
 Insulation thickness: 0.016 (0.41 mm)

Part No.	Pairs	Nominal Diameter		Jacket Thickness	
		Inch	mm	Inch	mm
M9526010	1	0.263	6.68	0.038	0.97

14 AWG (2.08 mm²)

Stranding: 7/0.0242 (7 x 0.62 mm)
 Insulation thickness: 0.016 (0.41 mm)

Part No.	Pairs	Nominal Diameter		Jacket Thickness	
		Inch	mm	Inch	mm
M9524010*	1	0.303	7.70	0.043	1.09

*Not CMG approved.

12AWG (3.29 mm²)

Stranding: 19/0.0185 (7 x 0.47 mm)
 Insulation thickness: 0.022 (0.56 mm)
 16 AWG (1.31 mm²) drain wire

Part No.	Pairs	Nominal Diameter		Jacket Thickness	
		Inch	mm	Inch	mm
5610B1201*	1	0.368	9.35	0.045	1.14

*Not CMG approved.

Manhattan™ Instrumentation Cable

600 V Pairs, Overall Foil Shield, PVC/Nylon, PVC

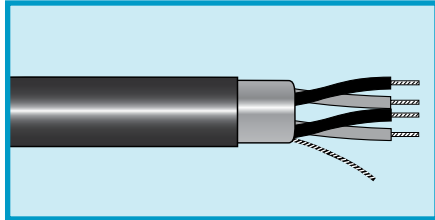

UL TC

Operating Temperature

- -25°C to +90°C

Conductor Color Coding

- Chart BW (page 529)

Materials

- Stranded bare copper conductors
- PVC/nylon insulation
- Aluminum/polyester foil shield, 25% overlap min.
Foil facing inward
- Stranded tinned copper drain wire one even AWG size smaller than conductor
- Black PVC jacket

Features

- UL Sunlight Resistant
- UL Direct Burial

Availability

100 ft (30.5 m)
 500 ft (152 m)
 1000 ft (305 m)
 Bulk, cut to length
 (Minimums may apply)

20 AWG (0.52 mm ²)					
Stranding: 7/0.0121 (7 x 0.51 mm)					
Insulation thickness: 0.013 (0.33 mm) PVC/0.003 (0.08 mm) nylon					
Part No.	Pairs	Nominal Diameter		Jacket Thickness	
		Inch	mm	Inch	mm
5616B2001	1	0.220	5.59	0.040	1.02

18 AWG (0.82 mm ²)					
Stranding: 7/0.0152 (7 x 0.31 mm)					
Insulation thickness: 0.016 (0.41 mm) PVC/0.005 (0.13 mm) nylon					
Part No.	Pairs	Nominal Diameter		Jacket Thickness	
		Inch	mm	Inch	mm
M8528010	1	0.279	7.09	0.048	1.22
M8708020	2	0.396	10.06	0.050	1.27
M8708040	4	0.456	11.58	0.050	1.27
M8708060	6	0.572	14.53	0.065	1.65
M8708080	8	0.617	15.67	0.065	1.65
M8708120	12	0.737	18.72	0.065	1.65
M8708160	16	0.856	21.74	0.085	2.16
M8708240	24	1.025	26.04	0.085	2.16
M8708360	36	1.188	30.18	0.085	2.16
M8708500	50	1.356	34.44	0.085	2.16

16 AWG (1.31 mm ²)					
Stranding: 7/0.0192 (7 x 0.49 mm)					
Insulation thickness: 0.016 (0.41 mm) PVC/0.005 (0.13 mm) nylon					
Part No.	Pairs	Nominal Diameter		Jacket Thickness	
		Inch	mm	Inch	mm
M8526010	1	0.303	7.70	0.048	1.22
M8706020	2	0.435	11.05	0.050	1.27
M8706040	4	0.504	12.80	0.050	1.27
M8706060	6	0.631	16.03	0.065	1.65
M8706080	8	0.682	17.32	0.065	1.65
M8706120	12	0.858	21.79	0.085	2.16
M8706160	16	0.949	24.10	0.085	2.16
M8706240	24	1.141	28.98	0.085	2.16
M8706360	36	1.325	33.66	0.085	2.16
M8706500	50	1.517	38.53	0.085	2.16



Manhattan™ Instrumentation Cable

600 V Pairs, Overall Foil Shield, PVC/Nylon, PVC

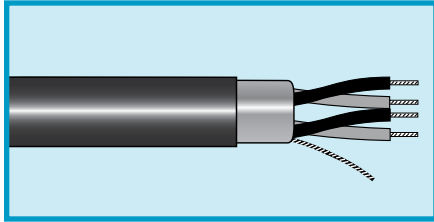

UL TC

Operating Temperature

- -25°C to +90°C

Conductor Color Coding

- Chart BW (page 529)

Materials

- Stranded bare copper conductors
- PVC/nylon insulation
- Aluminum/polyester foil shield, 25% overlap min.
Foil facing inward
- Stranded tinned copper drain wire one even AWG size smaller than conductor
- Black PVC jacket

Features

- UL Sunlight Resistant
- UL Direct Burial

Availability

100 ft (30.5 m)
 500 ft (152 m)
 1000 ft (305 m)
 Bulk, cut to length
 (Minimums may apply)

14 AWG (2.08 mm²)

Stranding: 7/0.0242 (7 x 0.61 mm)
 Insulation thickness: 0.016 (0.41 mm) PVC/0.005 (0.13 mm) nylon

Part No.	Pairs	Nominal Diameter		Jacket Thickness	
		Inch	mm	Inch	mm
M8524010	1	0.333	8.46	0.048	1.22
M8704020	2	0.484	12.29	0.050	1.27
M8704040	4	0.593	15.06	0.065	1.65
M8704060	6	0.706	17.93	0.065	1.65
M8704080	8	0.764	19.41	0.065	1.65
M8704120	12	0.961	24.41	0.085	2.16
M8704160	16	1.064	27.03	0.085	2.16
M8704240	24	1.286	32.66	0.085	2.16
M8704360	36	1.498	38.05	0.085	2.16
M8704500	50	1.778	45.16	0.115	2.92

12AWG (3.29 mm²)

Stranding: 19/0.0185 (19 x 0.47 mm)
 Insulation thickness: 0.016 (0.41 mm) PVC/0.005 (0.13 mm) nylon

Part No.	Pairs	Nominal Diameter		Jacket Thickness	
		Inch	mm	Inch	mm
5616B1201	1	0.374	9.50	0.050	1.27



Manhattan™ Instrumentation Cable

600 V Pairs, Overall and Individually Foil Shielded Pairs, PVC/Nylon, PVC

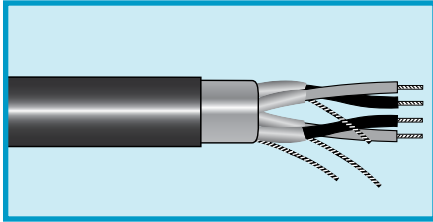

UL TC

Operating Temperature

- 25°C to +90°C

Conductor Color Coding

- Chart BW (page 529)

Materials

- Stranded bare copper conductors
- PVC/nylon insulation
- Aluminum/polyester foil shield, 25% overlap min. Foil facing inward
- Stranded tinned copper drain wire one even AWG size smaller than conductor
- Black PVC jacket

Features

- UL Sunlight Resistant
- UL Direct Burial

Availability

100 ft (30.5 m)

500 ft (152 m)

1000 ft (305 m)

Bulk, cut to length

(Minimums may apply)

18 AWG (0.82 mm²)

Stranding: 7/0.0152 (7 x 0.31 mm)
Insulation thickness: 0.016 (0.41 mm) PVC/0.005 (0.13 mm) nylon

Part No.	Pairs	Nominal Diameter		Jacket Thickness	
		Inch	mm	Inch	mm
M8748020	2	0.429	10.90	0.050	1.27
M8748040	4	0.497	12.62	0.050	1.27
M8748060	6	0.622	15.80	0.065	1.65
M8748080	8	0.672	17.07	0.065	1.65
M8748120	12	0.806	20.47	0.065	1.65
M8748160	16	0.935	23.75	0.085	2.16
M8748200	20	1.020	25.91	0.085	2.16
M8748240	24	1.123	28.52	0.085	2.16
M8748360	36	1.306	33.17	0.085	2.16
M8748500	50	1.497	38.02	0.085	2.16

16 AWG (1.31 mm²)

Stranding: 7/0.0192 (7 x 0.49 mm)
Insulation thickness: 0.016 (0.41 mm) PVC/0.005 (0.13 mm) nylon

Part No.	Pairs	Nominal Diameter		Jacket Thickness	
		Inch	mm	Inch	mm
M8746020	2	0.471	11.96	0.050	1.27
M8746040	4	0.577	14.66	0.065	1.65
M8746060	6	0.686	17.42	0.065	1.65
M8746080	8	0.742	18.85	0.065	1.65
M8746120	12	0.933	23.70	0.085	2.16
M8746160	16	1.034	26.26	0.085	2.16
M8746200	20	1.130	28.70	0.085	2.16
M8746240	24	1.247	31.67	0.085	2.16
M8746360	36	1.454	36.93	0.085	2.16
M8746500	50	1.730	43.94	0.115	2.92

14 AWG (2.08 mm²)

Stranding: 7/0.0242 (7 x 0.61 mm)
Insulation thickness: 0.016 (0.41 mm) PVC/0.005 (0.13 mm) nylon

Part No.	Pairs	Nominal Diameter		Jacket Thickness	
		Inch	mm	Inch	mm
M8744020	2	0.523	13.28	0.050	1.27
M8744040	4	0.641	16.28	0.065	1.65
M8744060	6	0.765	19.43	0.065	1.65
M8744080	8	0.869	22.07	0.085	2.16
M8744120	12	1.043	26.49	0.085	2.16
M8744160	16	1.158	29.41	0.085	2.16
M8744200	20	1.267	32.18	0.085	2.16
M8744240	24	1.401	35.59	0.085	2.16
M8744360	36	1.638	41.61	0.085	2.16
M8744500	50	1.945	49.40	0.115	2.92



Manhattan™ Instrumentation Cable

600 V Unshielded Pairs, PVC/Nylon, PVC

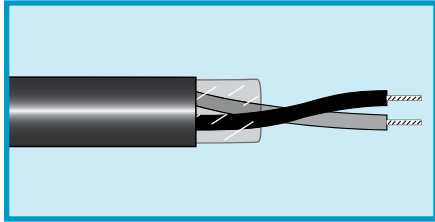

UL TC

Operating Temperature

- 25°C to +90°C

Conductor Color Coding

- Black, white

Materials

- Stranded bare copper conductors
- PVC/nylon insulation
- Black PVC jacket

Features

- UL Sunlight Resistant
- UL Direct Burial

Availability

1000 ft (305 m)
Bulk, cut to length
(Minimums may apply)

18 AWG (0.82 mm²)

Stranding: 7/0.0152 (7 x 0.31 mm)
Insulation thickness: 0.016 (0.41 mm) PVC/0.005 (0.13 mm) nylon

Part No.	Pairs	Nominal Diameter		Jacket Thickness	
		Inch	mm	Inch	mm
5606B1801	1	0.276	7.01	0.050	1.27

16 AWG (1.31 mm²)

Stranding: 7/0.0192 (7 x 0.49 mm)
Insulation thickness: 0.016 (0.41 mm) PVC/0.005 (0.13 mm) nylon

Part No.	Pairs	Nominal Diameter		Jacket Thickness	
		Inch	mm	Inch	mm
5606B1601	1	0.300	7.62	0.050	1.27



Manhattan™ Instrumentation Cable

300 V Unshielded Triads, PVC, PVC

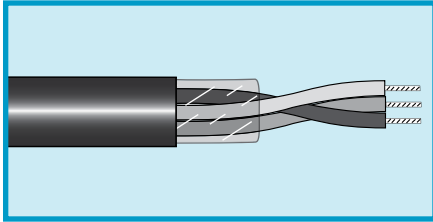

**UL PLTC, ITC
UL CL3
CSA CMG FT4**

Operating Temperature

- -20°C to +105°C

Conductor Color Coding

- Black, white, red

Materials

- Stranded bare copper conductors
- PVC insulation
- Black PVC jacket

Features

- UL Sunlight Resistant

Availability

100 ft (30.5 m)
500 ft (152 m)
1000 ft (305 m)
Bulk, cut to length
(Minimums may apply)

20 AWG (0.52 mm ²)					
Stranding: 7/0.0121 (7 x 0.31 mm) Insulation thickness: 0.016 (0.41 mm)					
Part No.	Triads	Nominal Diameter		Jacket Thickness	
		Inch	mm	Inch	mm
M9600010	1	0.226	5.74	0.038	0.97

18 AWG (0.81 mm ²)					
Stranding: 7/0.0152 (7 x 0.39 mm) Insulation thickness: 0.016 (0.41 mm)					
Part No.	Triads	Nominal Diameter		Jacket Thickness	
		Inch	mm	Inch	mm
M9608010	1	0.247	6.27	0.038	0.97

16 AWG (1.31 mm ²)					
Stranding: 7/0.0192 (7 x 0.49 mm) Insulation thickness: 0.016 (0.41 mm)					
Part No.	Triads	Nominal Diameter		Jacket Thickness	
		Inch	mm	Inch	mm
M9606010	1	0.293	7.44	0.038	0.97



Manhattan™ Instrumentation Cable

300 V Foil Shield, Triads, PVC, PVC

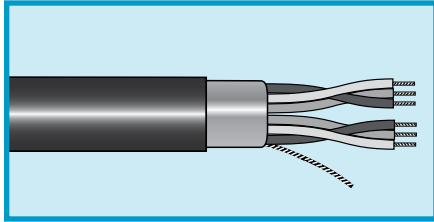

UL PLTC, ITC
UL CL3
CSA CMG FT4

Operating Temperature

- 20°C to +105°C

Conductor Color Coding

- Black, white, red

Materials

- Stranded bare copper conductors
- PVC insulation
- Aluminum/polyester foil shield, 25% overlap min.
Foil facing inward
- Stranded tinned copper drain wire one even AWG size smaller than conductor
- Black PVC jacket

Features

- UL Sunlight Resistant

Availability

100 ft (30.5 m)
500 ft (152 m)
1000 ft (305 m)
Bulk, cut to length
(Minimums may apply)

22 AWG (0.35 mm²)

Stranding: 7/30 (7 x 0.25 mm)
Insulation thickness: 0.013 (0.33 mm)
22 AWG (0.35 mm²) drain wire

Part No.	Triads	Nominal Diameter		Jacket Thickness	
		Inch	mm	Inch	mm
5640B2201	1	0.201	5.11	0.038	0.96

20 AWG (0.52 mm²)

Stranding: 7/0.0121 (7 x 0.31 mm)
Insulation thickness: 0.016 (0.41 mm)

Part No.	Triads	Nominal Diameter		Jacket Thickness	
		Inch	mm	Inch	mm
M9620010	1	0.230	5.84	0.038	0.97
5640B2004	4	0.410	10.41	0.055	1.39
5640B2012	12	0.640	16.28	0.065	1.65

18 AWG (0.82 mm²)

Stranding: 7/0.0152 (7 x 0.39 mm)
Insulation thickness: 0.016 (0.41 mm)

Part No.	Triads	Nominal Diameter		Jacket Thickness	
		Inch	mm	Inch	mm
M9628010	1	0.251	6.38	0.038	0.97

16 AWG (1.31 mm²)

Stranding: 7/0.0192 (7 x 0.49 mm)
Insulation thickness: 0.016 (0.41 mm)

Part No.	Triads	Nominal Diameter		Jacket Thickness	
		Inch	mm	Inch	mm
M9626010	1	0.287	7.29	0.043	1.09

14 AWG (2.08 mm²)

Stranding: 7/0.0242 (7 x 0.61 mm)
Insulation thickness: 0.016 (0.41 mm)

Part No.	Triads	Nominal Diameter		Jacket Thickness	
		Inch	mm	Inch	mm
M9624010*	1	0.319	8.10	0.043	1.09

*Not CMG approved.



Manhattan™ Instrumentation Cable

300 V Overall and Individually Foil Shielded Triads, PVC, PVC

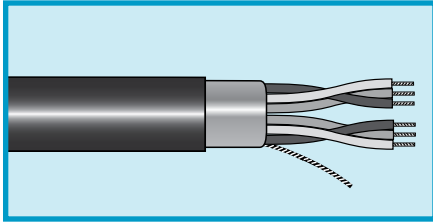

20 AWG (0.51 mm²)

Stranding: 7/0.0121 (7 x 0.54 mm)
 Insulation thickness: 0.013 (0.33 mm)
 22 AWG (0.35 mm²) drain wire

Part No.	Triads	Nominal Diameter		Jacket Thickness	
		Inch	mm	Inch	mm
5650B2004	4	0.458	11.63	0.055	1.39
5650B2008	8	0.586	14.88	0.055	1.39
5650B2012	12	0.723	18.36	0.065	1.65

**UL PLTC
 CSA CMG FT4**

Operating Temperature

- -20°C to +105°C
- -20°C to +60°C (CMG)

Conductor Color Coding

- Black, white, red
- White conductors are numbered

Materials

- Stranded bare copper conductors
- PVC insulation
- Aluminum/polyester foil shield, 25% overlap min. Foil facing inward
- Stranded tinned copper drain wire one even AWG size smaller than conductor
- Black PVC jacket

Features

- UL Sunlight Resistant

Availability

1000 ft (305 m)
 Bulk, cut to length
 (Minimums may apply)



Manhattan™ Instrumentation Cable

600 V Overall Foil Shield, Triads, PVC/Nylon, PVC

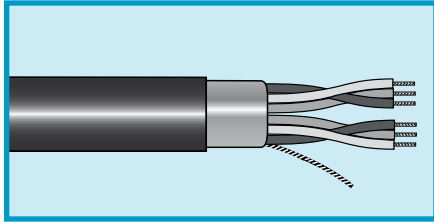

UL TC

Operating Temperature

- 25°C to +90°C

Conductor Color Coding

- Black, white, red
- White conductors are numbered

Materials

- Stranded bare copper conductors
- PVC/nylon insulation
- Aluminum/polyester foil shield, 25% overlap min.
Foil facing inward
- Stranded tinned copper drain wire one even AWG size smaller than conductor
- Black PVC jacket

Features

- UL Sunlight Resistant
- UL Direct Burial

Availability

100 ft (30.5 m)
500 ft (152 m)
1000 ft (305 m)
Bulk, cut to length
(Minimums may apply)

18 AWG (0.82 mm²)

Stranding: 7/0.0152 (7 x 0.39 mm)
Insulation thickness: 0.016 (0.41 mm) PVC/0.005 (0.13 mm) nylon

Part No.	Triads	Nominal Diameter		Jacket Thickness	
		Inch	mm	Inch	mm
M8628010	1	0.293	7.44	0.048	1.22
M8808020	2	0.450	11.43	0.050	1.27
M8808040	4	0.552	14.02	0.065	1.65
M8808080	8	0.708	17.98	0.065	1.65
M8808120	12	0.890	22.61	0.085	2.16
M8808240	24	1.186	30.12	0.085	2.16

16 AWG (1.31 mm²)

Stranding: 7/0.0192 (7 x 0.49 mm)
Insulation thickness: 0.016 (0.41 mm) PVC/0.005 (0.13 mm) nylon

Part No.	Triads	Nominal Diameter		Jacket Thickness	
		Inch	mm	Inch	mm
M8626010	1	0.319	8.10	0.048	1.22
M8806020	2	0.497	12.62	0.050	1.27
M8806040	4	0.609	15.47	0.065	1.65
M8806080	8	0.785	19.94	0.065	1.65
M8806120	12	0.987	25.07	0.085	2.16
M8806240	24	1.323	33.60	0.085	2.16

14 AWG (2.08 mm²)

Stranding: 7/0.0242 (7 x 0.62 mm)
Insulation thickness: 0.016 (0.41 mm) PVC/0.005 (0.13 mm) nylon

Part No.	Triads	Nominal Diameter		Jacket Thickness	
		Inch	mm	Inch	mm
M8624010	1	0.351	8.92	0.048	1.22
M8804020	2	0.585	14.86	0.065	1.65
M8804040	4	0.680	17.27	0.065	1.65
M8804080	8	0.923	23.44	0.085	2.16
M8804120	12	1.109	28.17	0.085	2.16
M8804240	24	1.495	37.97	0.085	2.16

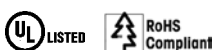

Manhattan™ Instrumentation Cable

600 V Overall and Individually Foil Shielded Multitriads, PVC/Nylon, PVC

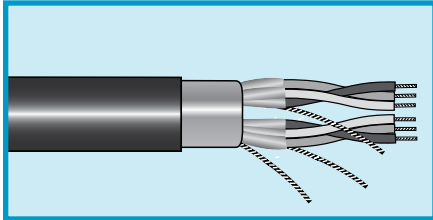

UL TC

Operating Temperature

- 25°C to +90°C

Conductor Color Coding

- Black, white, red
- White conductors are numbered

Materials

- Stranded bare copper conductors
- PVC/nylon insulation
- Aluminum/polyester foil shield, 25% overlap min., on both individual triads and overall cable
- Foil facing inward
- Stranded tinned copper drain wire one even AWG size smaller than conductor
- Black PVC jacket

Features

- UL Sunlight Resistant
- UL Direct Burial

Availability

100 ft (30.5 m)
 500 ft (152 m)
 1000 ft (305 m)
 Bulk, cut to length
 (Minimums may apply)

18 AWG (0.81 mm²)

Stranding: 7/0.0152 (7 x 0.39 mm)
 Insulation thickness: 0.016 (0.41 mm) PVC/0.005 (0.13 mm) nylon

Part No.	Triads	Nominal Diameter		Jacket Thickness	
		Inch	mm	Inch	mm
M8848020	2	0.501	12.73	0.050	1.27
M8848040	4	0.614	15.60	0.065	1.65
M8848080	8	0.832	21.13	0.085	2.16
M8848120	12	0.996	25.30	0.085	2.16
M8848240	24	1.336	33.93	0.065	2.16

16 AWG (1.31 mm²)

Stranding: 7/0.0192 (7 x 0.49 mm)
 Insulation thickness: 0.016 (0.41 mm) PVC/0.005 (0.13 mm) nylon

Part No.	Triads	Nominal Diameter		Jacket Thickness	
		Inch	mm	Inch	mm
M8846020	2	0.583	14.81	0.065	1.65
M8846040	4	0.677	17.20	0.065	1.65
M8846080	8	0.918	23.32	0.085	2.16
M8846120	12	1.104	28.04	0.085	2.16
M8846240	24	1.488	37.80	0.085	2.16

14 AWG (2.08 mm²)

Stranding: 7/0.0242 (7 x 0.61 mm)
 Insulation thickness: 0.016 (0.41 mm) PVC/0.005 (0.13 mm) nylon

Part No.	Triads	Nominal Diameter		Jacket Thickness	
		Inch	mm	Inch	mm
M8844020	2	0.648	16.46	0.065	1.65
M8844040	4	0.755	19.18	0.065	1.65
M8844080	8	1.026	26.06	0.085	2.16
M8844120	12	1.238	31.45	0.085	2.16
M8844240	24	1.738	44.15	0.115	2.92



Manhattan™ Instrumentation Cable

300 V Overall Foil Shield, Composite, PVC/Nylon, PVC

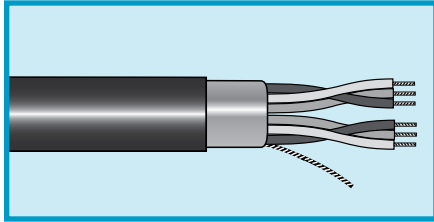

UL PLTC, ITC
UL CL3
CSA CMG FT4

Operating Temperature

- -20°C to +105°C

Conductor Color Coding

- Chart BW (page 529)

Materials

- Stranded bare copper conductors
- PVC insulation
- Communications wire is 22 AWG (0.35 mm²), 7/30 (7 x 0.25 mm) stranding, bare copper with 0.016 (0.41 mm) thick insulation
- Aluminum/polyester foil shield, 25% overlap min.
Foil facing inward
Stranded tinned copper drain wire one even AWG smaller than conductor
- Black PVC jacket

Features

- UL Sunlight Resistant

Availability

100 ft (30.5 m)
 500 ft (152 m)
 1000 ft (305 m)
 Bulk, cut to length
 (Minimums may apply)

20 AWG (0.52 mm²) Pairs

Stranding: 7/0.0121 (7 x 0.31 mm)
 Insulation thickness: 0.016 (0.41 mm)

Part No.	Pairs	Nominal Diameter		Jacket Thickness	
		Inch	mm	Inch	mm
M9700020	2	0.321	8.15	0.045	1.14
M9700040	4	0.400	10.16	0.053	1.35
M9700060	6	0.451	11.46	0.053	1.35
M9700080	8	0.511	12.98	0.053	1.35
M9700120	12	0.581	14.76	0.053	1.35
M9700160	16	0.660	16.76	0.063	1.60
5610B2020*	20	0.677	17.20	0.065	1.65
M9700240	24	0.791	20.09	0.063	1.60
M9700360	36	0.925	23.50	0.073	1.85
M9700500	50	1.069	27.15	0.073	1.85

*No communication wire.

18 AWG (0.81 mm²) Pairs

Stranding: 7/0.0152 (7 x 0.39 mm)
 Insulation thickness: 0.016 (0.41 mm) PVC/0.005 (0.13 mm) nylon

Part No.	Pairs	Nominal Diameter		Jacket Thickness	
		Inch	mm	Inch	mm
M9708020	2	0.353	8.97	0.045	1.14
M9708040	4	0.431	10.95	0.053	1.35
M9708060	6	0.499	12.67	0.053	1.35
M9708080	8	0.558	14.17	0.053	1.35
M9708120	12	0.664	16.87	0.063	1.60
M9708160	16	0.735	18.67	0.063	1.60
M9708240	24	0.905	22.99	0.073	1.85
M9708360	36	1.049	26.64	0.073	1.85
M9708500	50	1.199	30.45	0.073	1.85

16 AWG (1.31 mm²)

Stranding: 7/0.0192 (7 x 0.49 mm)
 Insulation thickness: 0.016 (0.41 mm) PVC

Part No.	Pairs	Nominal Diameter		Jacket Thickness	
		Inch	mm	Inch	mm
M9706020	2	0.409	10.39	0.053	1.35
M9706040	4	0.471	11.96	0.053	1.35
M9706060	6	0.559	14.20	0.053	1.35
M9706080	8	0.639	16.23	0.063	1.60
M9706120	12	0.747	18.97	0.063	1.60
M9706160	16	0.829	21.06	0.063	1.60
M9706240	24	1.023	25.98	0.073	1.85
M9706360	36	1.189	30.20	0.073	1.85
M9706500	50	1.382	35.10	0.083	2.11



Manhattan™ Instrumentation Cable

300 V Overall and Individually Foil Shielded Pairs, Composite PVC/Nylon, PVC

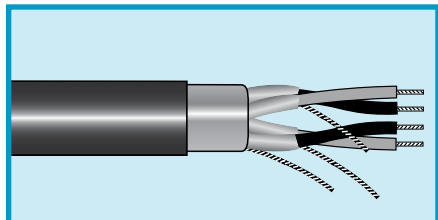

UL PLTC, ITC
UL CL3
CSA CMG FT4

Operating Temperature

- 20°C to +105°C

Conductor Color Coding

- Chart BW (page 529)

Materials

- Stranded bare copper conductors
- PVC/nylon insulation
- Aluminum/polyester foil shield, 25% overlap min. Foil facing inward
- Stranded tinned copper drain wire one even AWG size smaller than conductors
- Black PVC jacket

Features

- UL Sunlight Resistant

Availability

100 ft (30.5 m)
500 ft (152 m)
1000 ft (305 m)
Bulk, cut to length
(Minimums may apply)



20 AWG (0.52 mm²)*

Stranding: 7/0.0121 (7 x 0.31 mm)
Insulation thickness: 0.016 (0.41 mm)

Part No.	Pairs	Nominal Diameter		Jacket Thickness	
		Inch	mm	Inch	mm
M9740020	2	0.349	8.86	0.045	1.14
M9740040	4	0.427	10.85	0.053	1.35
M9740060	6	0.493	12.52	0.053	1.35
M9740080	8	0.539	13.69	0.053	1.35
M9740120	12	0.643	16.33	0.063	1.60
M9740160	16	0.724	18.39	0.063	1.60
5620B2020**	20	0.752	19.10	0.065	1.65
M9740240	24	0.882	22.40	0.073	1.85
M9740360	36	1.011	25.68	0.073	1.85
M9740500	50	1.169	29.69	0.073	1.85

*Communications wire is 22 AWG (0.35 mm²), 7/30 (7 x 0.25 mm) stranding, bare copper with 0.016 (0.41 mm) thick insulation.

**0.013 (0.33 mm) insulation thickness.

18 AWG (0.82 mm²)

Stranding: 7/0.0152 (7 x 0.39 mm)
Insulation thickness: 0.016 (0.41 mm) PVC

Part No.	Pairs	Nominal Diameter		Jacket Thickness	
		Inch	mm	Inch	mm
M9748020	2	0.401	10.19	0.053	1.35
M9748040	4	0.463	11.76	0.053	1.35
M9748060	6	0.547	13.89	0.053	1.35
M9748080	8	0.616	15.65	0.063	1.60
M9748120	12	0.712	18.08	0.063	1.60
M9748160	16	0.805	20.45	0.063	1.60
5620B1820	20	0.921	23.36	0.075	1.91
M9748240	24	0.983	24.97	0.073	1.85
M9748360	36	1.130	28.70	0.073	1.85
M9748500	50	1.349	34.26	0.083	2.11

*Communications wire is 22 AWG (0.35 mm²), 7/30 (7 x 0.25 mm) stranding, bare copper with 0.016 (0.41 mm) thick insulation.

16 AWG (1.31 mm²)

Stranding: 7/0.0192 (7 x 0.49 mm)
Insulation thickness: 0.016 (0.41 mm) PVC

Part No.	Pairs	Nominal Diameter		Jacket Thickness	
		Inch	mm	Inch	mm
M9746020	2	0.441	11.20	0.053	1.35
M9746040	4	0.512	13.00	0.053	1.35
M9746060	6	0.630	16.00	0.063	1.60
M9746080	8	0.690	17.53	0.063	1.60
M9746120	12	0.819	20.80	0.063	1.60
M9746160	16	0.929	23.60	0.073	1.85
M9746240	24	1.123	28.52	0.073	1.85
M9746360	36	1.328	33.73	0.083	2.11
M9746500	50	1.521	38.63	0.083	2.11

*Communications wire is 22 AWG (0.35 mm²), 7/30 (7 x 0.25 mm) stranding, bare copper with 0.016 (0.41 mm) thick insulation.

Manhattan™ Computer Cable

300 V Unshielded, Multiconductor, PVC, PVC

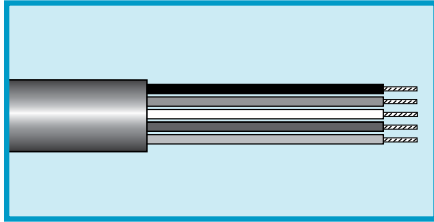

UL AWM 2464
UL CL2
CSA AWM I/II A/B FT4

Applications

- Control and signal wiring
- Computers
- Instrumentation

Operating Temperature

- -20°C to +105°C (CSA)
- -20°C to +90°C (CL2)
- -20°C to +80°C (AWM)

Conductor Color Coding

- See tables

Materials

- Stranded tinned copper conductors
- PVC insulation
- Slate PVC jacket

Availability

100 ft (30.5 m)
 500 ft (152 m)
 1000 ft (305 m)
 (Minimums may apply)

20 AWG (0.50 mm²)

Stranding: 10/30 (10 x 0.25 mm)
 Insulation thickness: 0.016 (0.41 mm)

Part No.	Conductors	Nominal Diameter		Jacket Thickness		Color Code
		Inch	mm	Inch	mm	
882002	2	0.202	5.13	0.032	0.81	R
882003	3	0.213	5.41	0.032	0.81	R
882004	4	0.231	5.87	0.032	0.81	R
882005	5	0.251	6.38	0.032	0.81	R
882006	6	0.272	6.91	0.032	0.81	R
882007	7	0.272	6.91	0.032	0.81	R
882008	8	0.293	7.44	0.032	0.81	R
882010	10	0.318	8.08	0.032	0.81	R
882012	12	0.338	8.59	0.032	0.81	R
882015	15	0.389	9.88	0.032	0.81	F
882020	20	0.430	10.92	0.032	0.81	R
882025	25	0.471	11.96	0.032	0.81	R

18 AWG (0.81 mm²)

Stranding: 16/30 (16 x 0.25 mm)
 Insulation thickness: 0.016 (0.41 mm)

Part No.	Conductors	Nominal Diameter		Jacket Thickness		Color Code
		Inch	mm	Inch	mm	
881802	2	0.222	5.64	0.032	0.81	R
881803	3	0.234	5.94	0.032	0.81	F
881804	4	0.255	6.48	0.032	0.81	R
881805	5	0.278	7.06	0.032	0.81	R
881806	6	0.289	7.34	0.032	0.81	R
881807	7	0.302	7.67	0.032	0.81	R
881808	8	0.341	8.66	0.032	0.81	R
881809	9	0.379	9.63	0.032	0.81	R
881812	12	0.408	10.36	0.032	0.81	F
881815	15	0.465	11.81	0.032	0.81	F
881820	20	0.511	12.98	0.032	0.81	R
881825	25	0.600	15.24	0.032	0.81	F



Manhattan™ Computer Cable

300 V Unshielded, Multiconductor, PVC, PVC

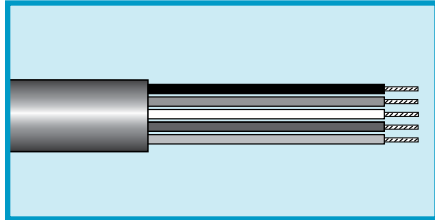

UL AWM 2464
UL CL2
CSA AWM I/II A/B FT4

Applications

- Control and signal wiring
- Computers
- Instrumentation

Operating Temperature

- -20°C to +105°C (CSA)
- -20°C to +90°C (CL2)
- -20°C to +80°C (AWM)

Conductor Color Coding

- See tables

Materials

- Stranded tinned copper conductors
- PVC insulation
- Slate PVC jacket

Availability

100 ft (30.5 m)
 500 ft (152 m)
 1000 ft (305 m)
 (Minimums may apply)

16 AWG (1.32 mm²)

Stranding: 26/30 (26 x 0.25 mm)
 Insulation thickness: 0.032 (0.81 mm)

Part No.	Conductors	Nominal Diameter		Jacket Thickness		Color Code
		Inch	mm	Inch	mm	
881602	2	0.312	7.92	0.032	0.81	F
881603	3	0.329	8.36	0.032	0.81	F
881604	4	0.375	9.53	0.045	1.14	F
881605	5	0.405	10.29	0.045	1.14	F
881606	6	0.410	10.41	0.045	1.14	R
881607	7	0.455	11.56	0.045	1.14	F
881610	10	0.578	14.68	0.045	1.14	R

14 AWG (2.08 mm²)

Stranding: 41/30 (65 x 0.25 mm)
 Insulation thickness: 0.031 (0.78 mm)

Part No.	Conductors	Nominal Diameter		Jacket Thickness		Color Code
		Inch	mm	Inch	mm	
881403	3	0.378	9.60	0.035	0.89	F
881404	4	0.434	11.02	0.045	1.14	F
881405	5	0.485	12.32	0.060	1.52	F

12 AWG (3.29 mm²)

Stranding: 65/30 (65 x 0.25 mm)
 Insulation thickness: 0.031 (0.78 mm)

Part No.	Conductors	Nominal Diameter		Jacket Thickness		Color Code
		Inch	mm	Inch	mm	
881202	2	0.396	10.06	0.032	0.81	F
881203	3	0.423	10.74	0.032	0.81	F



Manhattan™ Computer Cable

300 V Unshielded, Multiconductor, SR-PVC, PVC

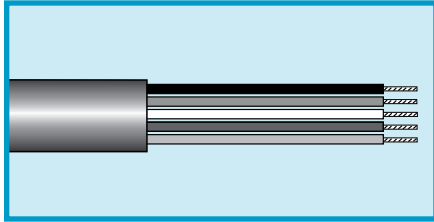

UL AWM 2464
UL CL2
CSA AWM I/II A/B FT4

Applications

- Control and signal wiring
- Computers
- Instrumentation

Operating Temperature

- -20°C to +105°C (CSA)
- -20°C to +90°C (CL2)
- -20°C to +80°C (AWM)

Conductor Color Coding

- See tables

Materials

- Stranded tinned copper conductors
- Semirigid PVC insulation
- Slate PVC jacket

Availability

100 ft (30.5 m)
 500 ft (152 m)
 1000 ft (305 m)
 (Minimums may apply)

24 AWG (0.22 mm²)

Stranding: 7/32 (7 x 0.20 mm)
 Insulation thickness: 0.010 (0.25 mm)

Part No.	Conductors	Nominal Diameter		Jacket Thickness		Color Code
		Inch	mm	Inch	mm	
882402	2	0.152	3.86	0.032	0.81	E
882403	3	0.159	4.04	0.032	0.81	E
882404	4	0.170	4.32	0.032	0.81	E
882406	6	0.197	5.00	0.032	0.81	E

22 AWG (0.35 mm²)

Stranding: 7/30 (7 x 0.25 mm)
 Insulation thickness: 0.010 (0.25 mm)

Part No.	Conductors	Nominal Diameter		Jacket Thickness		Color Code
		Inch	mm	Inch	mm	
882202	2	0.164	4.17	0.032	0.81	R
882203	3	0.172	4.37	0.032	0.81	R
882204	4	0.185	4.70	0.032	0.81	R
882205	5	0.200	5.08	0.032	0.81	R
882206	6	0.215	5.46	0.032	0.81	R
882207	7	0.215	5.46	0.032	0.81	R
882208	8	0.230	5.84	0.032	0.81	R
882209	9	0.246	6.25	0.032	0.81	R
882210	10	0.264	6.71	0.032	0.81	R
882212	12	0.272	6.91	0.032	0.81	R
882215	15	0.294	7.47	0.032	0.81	F
882220	20	0.326	8.28	0.032	0.81	F
882225	25	0.364	9.25	0.032	0.81	F
882230	30	0.385	9.78	0.032	0.81	F
882240	40	0.429	10.90	0.032	0.81	F
882250	50	0.478	12.14	0.035	0.89	F
882260	60	0.520	13.21	0.035	0.89	F



Manhattan™ Computer Cable

300 V Unshielded, Multiconductor, SR-PVC, PVC

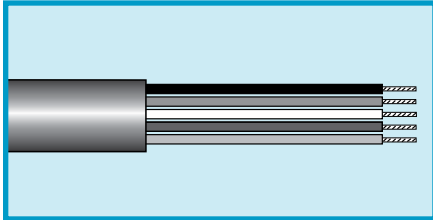

UL AWM 2343
UL CMG
CSA CMG FT4

Applications

- Control and signal wiring
- Computers
- Instrumentation

Operating Temperature

- -20°C to +80°C (AWM)
- -20°C to +75°C (CMG)

Conductor Color Coding

- Chart E (page 532)

Materials

- Stranded tinned copper conductors
- Semirigid PVC insulation
- Slate PVC jacket

Availability

100 ft (30.5 m)
 500 ft (152 m)
 1000 ft (305 m)
 Bulk, cut to length
 (Minimums may apply)

24 AWG (0.22 mm²)

Stranding: 7/32 (10 x 0.20 mm)
 Insulation thickness: 0.010 (0.25 mm)

Part No.	Conductors	Nominal Diameter		Jacket Thickness	
		Inch	mm	Inch	mm
M4501	7	0.262	6.65	0.063	1.60
M4502	12	0.312	7.92	0.063	1.60
M4503	15	0.332	8.43	0.063	1.60
M4504	19	0.349	8.86	0.063	1.60
M4506	37	0.437	11.10	0.063	1.60

22 AWG (0.35 mm²)

Stranding: 7/30 (7 x 0.25 mm)
 Insulation thickness: 0.010 (0.25 mm)

Part No.	Conductors	Nominal Diameter		Jacket Thickness	
		Inch	mm	Inch	mm
M4508	2	0.229	5.82	0.063	1.60
M4510	7	0.280	7.11	0.063	1.60
M4511	12	0.337	8.56	0.063	1.60
M4512	15	0.360	9.14	0.063	1.60
M4513	19	0.379	9.63	0.063	1.60
M4514	27	0.437	11.10	0.063	1.60
M4515	37	0.479	12.17	0.063	1.60

20 AWG (0.56 mm²)

Stranding: 7/28 (7 x 0.32 mm)
 Insulation thickness: 0.010 (0.25 mm)

Part No.	Conductors	Nominal Diameter		Jacket Thickness	
		Inch	mm	Inch	mm
M4517	2	0.245	6.22	0.063	1.60
M4518	5	0.287	7.29	0.063	1.60
M4519	7	0.304	7.72	0.063	1.60
M4520	12	0.370	9.40	0.063	1.60
M4522	19	0.419	10.64	0.063	1.60
M4523	27	0.486	12.34	0.063	1.60
M4524	37	0.535	13.59	0.063	1.60



Manhattan™ Computer Cable

300 V Foil Shield, Multiconductor, PVC, PVC

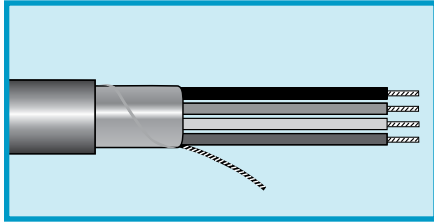

UL AWM 2464
UL CMG
CSA CMG FT4

Applications

- Control and signal wiring
- Computers
- Instrumentation

Operating Temperature

- -20°C to +80°C (AWM)
- -20°C to +75°C (CMG)

Conductor Color Coding

- See tables

Materials

- Stranded tinned copper conductors
- PVC insulation
- Aluminum/polyester foil shield, 25% overlap min.
Foil facing inward
- Stranded tinned copper drain wire equal in size to conductor
- Slate PVC jacket

Availability

100 ft (30.5 m)
500 ft (152 m)
1000 ft (305 m)
Bulk, cut to length
(Minimums may apply)

20 AWG (0.56 mm²)

Stranding: 7/28 (10 x 0.32 mm)
Insulation thickness: 0.016 (0.41 mm)
Color Code D

Part No.	Conductors	Nominal Diameter		Jacket Thickness	
		Inch	mm	Inch	mm
M4660	2	0.211	5.36	0.032	0.81
M4661	3	0.222	5.64	0.032	0.81
M4662	4	0.240	6.10	0.032	0.81
M4664	6	0.282	7.16	0.032	0.81
M4665	8	0.304	7.72	0.032	0.81
M4666	10	0.351	8.92	0.032	0.81
M4668	15	0.393	9.98	0.032	0.81
M4670	20	0.437	11.10	0.032	0.81
M4672	25	0.491	12.47	0.032	0.81
M4673	30	0.520	13.21	0.032	0.81
M4675	40	0.625	15.88	0.053	1.35
M4677	50	0.685	17.40	0.053	1.35

18 AWG (0.81 mm²)

Stranding: 16/30 (16 x 0.25 mm)
Insulation thickness: 0.016 (0.41 mm)
Color Code D

Part No.	Conductors	Nominal Diameter		Jacket Thickness	
		Inch	mm	Inch	mm
M4690	2	0.229	5.82	0.032	0.81
M4691	3	0.241	6.12	0.032	0.81
M4692*	2	0.229	5.82	0.032	0.81
M4693*	3	0.241	6.12	0.032	0.81
M4694	4	0.262	6.65	0.032	0.81
M4696	6	0.309	7.85	0.032	0.81
M4697	8	0.334	8.48	0.032	0.81
M4698	10	0.387	9.83	0.032	0.81
M4700	15	0.436	11.07	0.032	0.81
M4702	20	0.485	12.32	0.032	0.81
M4704	25	0.545	13.84	0.032	0.81
M4706	30	0.620	15.75	0.053	1.35
M4708	40	0.690	17.53	0.053	1.35

*Conductor color coding: 1 Brown, 2 Blue, 3 Green/Yellow.



Manhattan™ Computer Cable

300 V Foil Shield, Multiconductor, PVC, PVC

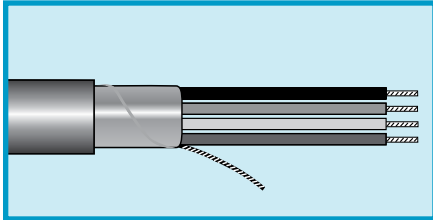

UL AWM 2464
UL CMG
CSA CMG FT4

Applications

- Control and signal wiring
- Computers
- Instrumentation

Operating Temperature

- -20°C to +80°C (AWM)
- -20°C to +75°C (CMG)

Conductor Color Coding

- See tables

Materials

- Stranded tinned copper conductors
- PVC insulation
- Aluminum/polyester foil shield, 25% overlap min.
Foil facing inward
- Stranded tinned copper drain wire equal in size to conductor
- Slate PVC jacket

Availability

100 ft (30.5 m)
 500 ft (152 m)
 1000 ft (305 m)
 Bulk, cut to length
 (Minimums may apply)

16 AWG (1.32 mm²)

Stranding: 19/0.0117 (19 x 0.30 mm)
 Insulation thickness: 0.016 (0.41 mm)
 Color Code R

Part No.	Conductors	Nominal Diameter		Jacket Thickness	
		Inch	mm	Inch	mm
M4720	2	0.253	6.43	0.032	0.81
M4721	3	0.267	6.78	0.032	0.81
M4722*	2	0.253	6.43	0.032	0.81
M4723*	3	0.267	6.78	0.032	0.81
M4724	4	0.291	7.39	0.032	0.81
M4726	6	0.345	8.76	0.032	0.81
M4728	8	0.374	9.50	0.032	0.81
M4730	10	0.435	11.05	0.032	0.81
M4732	15	0.489	12.42	0.032	0.81
M4734	20	0.547	13.89	0.032	0.81
M4736	30	0.697	17.70	0.053	1.35

*Conductor color coding: 1 Brown, 2 Blue, 3 Green/Yellow.



Manhattan™ Computer Cable

300 V Foil Shield, Multiconductor, PVC, PVC

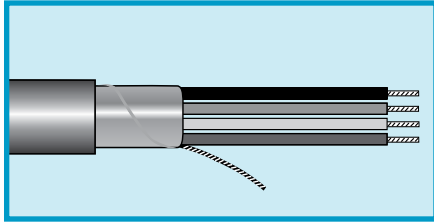

24 AWG (0.22 mm²)					
Stranding: 7/32 (7 x 0.20 mm)					
Insulation thickness: 0.010 (0.25 mm)					
Part No.	Conductors	Nominal Diameter		Jacket Thickness	
		Inch	mm	Inch	mm
1012405	5	0.190	4.83	0.035	0.89
1012407	7	0.205	5.21	0.035	0.89
1012409	9	0.236	5.99	0.035	0.89

UL AWM 2464
UL CL2
CSA AWM I/II A/B FT4

Applications

- Sound broadcast
- Instrumentation

Operating Temperature

- -20°C to +80°C

Conductor Color Coding

- Chart R (page 535)

Materials

- Stranded tinned copper conductors
- PVC insulation
- Aluminum/polyester foil shield, 25% overlap min.
Foil facing outward
- Stranded tinned copper drain wire equal in size to conductor
- Slate PVC jacket

Availability

100 ft (30.5 m)
 500 ft (152 m)
 1000 ft (305 m)
 Bulk, cut to length
 (Minimums may apply)



Manhattan™ Computer Cable

300 V Foil Shield, Multiconductor, SR-PVC, PVC

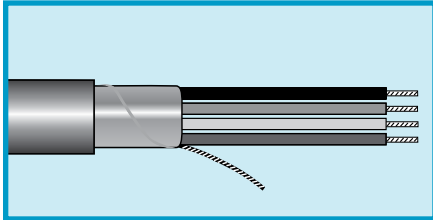

UL AWM 2464
UL CMG
CSA CMG FT4

Applications

- Computer and control applications

Operating Temperature

- -20°C to +80°C (AWM)
- -20°C to +75°C (CMG)

Conductor Color Coding

- Chart E (page 532)

Materials

- Stranded tinned copper conductors
- Semirigid PVC insulation
- Aluminum/polyester foil shield, 25% overlap min.
Foil facing inward
Stranded tinned copper drain wire equal in size to conductor
- Slate PVC jacket

Availability

100 ft (30.5 m)
 500 ft (152 m)
 1000 ft (305 m)
 Bulk, cut to length
 (Minimums may apply)

24 AWG (0.22 mm²)

Stranding: 7/32 (7 x 0.20 mm)
 Insulation thickness: 0.010 (0.25 mm)

Part No.	Conductors	Nominal Diameter		Jacket Thickness	
		Inch	mm	Inch	mm
M4602	2	0.159	4.04	0.032	0.81
M4603	3	0.166	4.22	0.032	0.81
M4604	4	0.178	4.52	0.032	0.81
M4606	6	0.204	5.18	0.032	0.81
M4607	8	0.217	5.51	0.032	0.81
M4608	10	0.247	6.27	0.032	0.81
M4610	15	0.273	6.93	0.032	0.81
M4612	20	0.301	7.65	0.032	0.81
M4614	25	0.335	8.51	0.032	0.81
M4616	30	0.353	8.97	0.032	0.81
M4618	40	0.393	9.98	0.032	0.81
M4620	50	0.430	10.92	0.032	0.81

22 AWG (0.35 mm²)

Stranding: 7/30 (7 x 0.25 mm)
 Insulation thickness: 0.010 (0.25 mm)

Part No.	Conductors	Nominal Diameter		Jacket Thickness	
		Inch	mm	Inch	mm
M4633	2	0.171	4.34	0.032	0.81
M4634	3	0.179	4.55	0.032	0.81
M4635	4	0.192	4.88	0.032	0.81
M4636	6	0.222	5.64	0.032	0.81
M4638	8	0.237	6.02	0.032	0.81
M4640	10	0.271	6.88	0.032	0.81
M4642	15	0.301	7.65	0.032	0.81
M4644	20	0.333	8.46	0.032	0.81
M4646	25	0.371	9.42	0.032	0.81
M4648	30	0.392	9.96	0.032	0.81
M4650	40	0.436	11.07	0.032	0.81
M4652	50	0.479	12.17	0.032	0.81



Manhattan™ Computer Cable

300 V Foil/Braid Shield, Multiconductor, SR-PVC, PVC

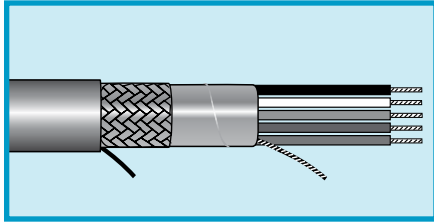

UL AWM 2464
UL CMG
CSA CMG FT4

Applications

- RS-232
- Modems
- Multiplexers
- Serial data interfaces

Operating Temperature

- -20°C to +80°C (AWM)
- -20°C to +75°C (CMG)

Conductor Color Coding

- See tables

Materials

- Stranded tinned copper conductors
- Semirigid PVC insulation
- Foil + braid shield
Aluminum/polyester foil shield,
25% overlap min.
Foil facing outward
Stranded tinned copper drain
wire equal in size to conductor
Tinned copper braid, 65% or
70% coverage
- Slate PVC jacket

Availability

100 ft (30.5 m)
500 ft (152 m)
1000 ft (305 m)
Bulk, cut to length
(Minimums may apply)

65% Braid Coverage

28 AWG (0.08 mm²)

Stranding: 7/36 (7 x 0.12 mm)
Insulation thickness: 0.010 (0.25 mm)
Color Code D

Part No.	Conductors	Nominal Diameter		Jacket Thickness	
		Inch	mm	Inch	mm
M2403	3	0.165	4.19	0.032	0.81
M2404	4	0.175	4.45	0.032	0.81
M2405	5	0.185	4.70	0.032	0.81
M2406	6	0.196	4.98	0.032	0.81
M2407	7	0.196	4.98	0.032	0.81
M2408	8	0.206	5.23	0.032	0.81
M2409	9	0.217	5.51	0.032	0.81
M2410	10	0.230	5.84	0.032	0.81
M2412	15	0.251	6.38	0.032	0.81
M2414	25	0.300	7.62	0.032	0.81
M2416	37	0.335	8.51	0.032	0.81
M2420	50	0.376	9.55	0.032	0.81

Mutual capacitance: 25 pF/ft (82 pF/m)
Ground capacitance: 45 pF/ft (147.6 pF/m)

70% Braid Coverage

24 AWG (0.22 mm²)

Stranding: 7/32 (7 x 0.20 mm)
Insulation thickness: 0.010 (0.25 mm)
Color Code E

Part No.	Conductors	Nominal Diameter		Jacket Thickness	
		Inch	mm	Inch	mm
M5302	2	0.181	4.60	0.032	0.81
M5303	3	0.188	4.78	0.032	0.81
M5304	4	0.199	5.05	0.032	0.81
M5306	6	0.226	5.74	0.032	0.81
M5307	8	0.239	6.07	0.032	0.81
M5308	10	0.269	6.83	0.032	0.81
M5310	15	0.295	7.49	0.032	0.81
M5312	20	0.323	8.20	0.032	0.81
M5314	25	0.357	9.07	0.032	0.81
M5316	30	0.375	9.53	0.032	0.81
M5318	40	0.415	10.54	0.032	0.81
M5320	50	0.452	11.48	0.032	0.81

Mutual capacitance: 32 pF/ft (105 pF/m)
Ground capacitance: 58 pF/ft (190.3 pF/m)

Part No. M5302:
Mutual capacitance: 35 pF/ft (114.8 pF/m)
Ground capacitance: 63 pF/ft (206.7 pF/m)



Manhattan™ Computer Cable

300 V Foil/Braid Shield, Multiconductor, SR-PVC, PVC

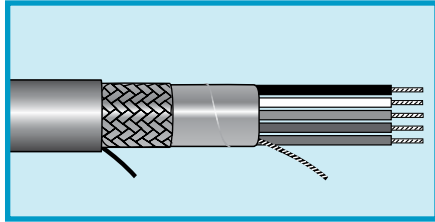

UL AWM 2464
UL CMG
CSA CMG FT4

Applications

- RS-232
- Modems
- Multiplexers
- Serial data interfaces

Operating Temperature

- -20°C to +80°C (AWM)
- -20°C to +75°C (CMG)

Conductor Color Coding

- See tables

Materials

- Stranded tinned copper conductors
- Semirigid PVC insulation
- Foil + braid shield
 Aluminum/polyester foil shield,
 25% overlap min.
 Foil facing outward
 Stranded tinned copper drain
 wire equal in size to conductor
 Tinned copper braid, 65% or
 70% coverage
- Slate PVC jacket

Availability

100 ft (30.5 m)
 500 ft (152 m)
 1000 ft (305 m)
 Bulk, cut to length
 (Minimums may apply)

65% Braid Coverage

24 AWG (0.22 mm²)

Stranding: 7/32 (7 x 0.20 mm)
 Insulation thickness: 0.010 (0.25 mm)

Part No.	Conductors	Nominal Diameter		Jacket Thickness		Color Code
		Inch	mm	Inch	mm	
M2438	3	0.185	4.70	0.032	0.81	O
M2439	4	0.196	4.98	0.032	0.81	O
M2440	5	0.209	5.31	0.032	0.81	O
M2441	6	0.223	5.66	0.032	0.81	O
M2442	7	0.223	5.66	0.032	0.81	O
M2443	8	0.236	5.99	0.032	0.81	O
M2444	9	0.250	6.35	0.032	0.81	O
M2445	10	0.266	6.76	0.032	0.81	O
M2447	15	0.292	7.42	0.032	0.81	F
M2449	25	0.354	8.99	0.032	0.81	F
M2452	37	0.398	10.11	0.032	0.81	F
M2455	50	0.449	11.40	0.032	0.81	F

Mutual capacitance: 32 pF/ft (105 pF/m)
 Ground capacitance: 58 pF/ft (190 pF/m)

70% Braid Coverage

22 AWG (0.35 mm²)

Stranding: 7/30 (7 x 0.25 mm)
 Insulation thickness: 0.010 (0.25 mm)
 Color Code E

Part No.	Conductors	Nominal Diameter		Jacket Thickness	
		Inch	mm	Inch	mm
M5333	2	0.193	4.90	0.032	0.81
M5334	3	0.201	5.11	0.032	0.81
M5335	4	0.214	5.44	0.032	0.81
M5336	6	0.244	6.20	0.032	0.81
M5338	8	0.259	6.58	0.032	0.81
M5340	10	0.293	7.44	0.032	0.81
M5342	15	0.323	8.20	0.032	0.81
M5344	20	0.355	9.02	0.032	0.81
M5346	25	0.393	9.98	0.032	0.81
M5348	30	0.414	10.52	0.032	0.81
M5350	40	0.458	11.63	0.032	0.81
M5352	50	0.501	12.73	0.032	0.81

Mutual capacitance: 36 pF/ft (118.1 pF/m)
 Ground capacitance: 65 pF/ft (213.3 pF/m)

Part No. M5333:
 Mutual capacitance: 39 pF/ft (128 pF/m)
 Ground capacitance: 70 pF/ft (229.7 pF/m)



Manhattan™ Computer Cable

300 V Foil/Braid Shield, Multiconductor, SR-PVC, PVC

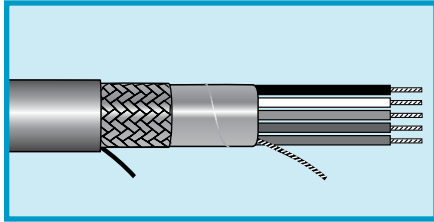

UL AWM 2464
UL CMG
CSA CMG FT4

Applications

- RS-232
- Modems
- Multiplexers
- Serial data interfaces

Operating Temperature

- -20°C to +80°C (AWM)
- -20°C to +75°C (CMG)

Conductor Color Coding

- See table

Materials

- Stranded tinned copper conductors
- Semirigid PVC insulation
- Foil + braid shield
Aluminum/polyester foil shield,
25% overlap min.
Foil facing outward
Stranded tinned copper drain
wire equal in size to conductor
Tinned copper braid, 65% or
70% coverage
- Slate PVC jacket

Availability

100 ft (30.5 m)
500 ft (152 m)
1000 ft (305 m)
Bulk, cut to length
(Minimums may apply)

65% Braid Coverage

22 AWG (0.35 mm²)

Stranding: 7/30 (7 x 0.25 mm)
Insulation thickness: 0.010 (0.25 mm)

Part No.	Conductors	Nominal Diameter		Jacket Thickness		Color Code
		Inch	mm	Inch	mm	
M2473	3	0.198	5.03	0.032	0.81	O
M2474	4	0.211	5.36	0.032	0.81	O
M2475	5	0.226	5.74	0.032	0.81	O
M2476	6	0.241	6.12	0.032	0.81	O
M2477	7	0.241	6.12	0.032	0.81	O
M2478	8	0.256	6.50	0.032	0.81	O
M2479	9	0.272	6.91	0.032	0.81	O
M2480	10	0.290	7.37	0.032	0.81	O
M2481	15	0.320	8.13	0.032	0.81	F
M2482	25	0.390	9.91	0.032	0.81	F
M2483	37	0.440	11.18	0.032	0.81	F
M2485	50	0.504	12.80	0.035	0.86	F

Mutual capacitance: 36 pF/ft (118.1 pF/m)
Ground capacitance: 65 pF/ft (213.3 pF/m)



Manhattan™ Computer Cable

300 V Foil/Braid Shield, Multiconductor, SR-PVC, PVC

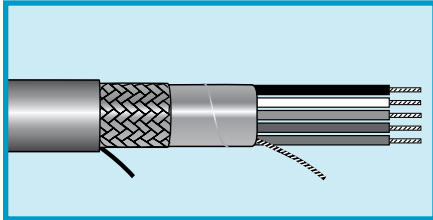

UL AWM 2343
UL CMG
CSA CMG FT4

Applications

- Computer and control applications

Operating Temperature

- -20°C to +80°C (AWM)
- -20°C to +75°C (CMG)

Conductor Color Coding

- Chart E (page 532)

Materials

- Stranded tinned copper conductors
- Semirigid PVC insulation
- Foil + braid shield
 Aluminum/polyester foil shield,
 25% overlap min.
 Foil facing outward
 Stranded tinned copper drain
 wire equal in size to conductor
 Tinned copper braid,
 70% coverage
- Slate PVC jacket

Availability

100 ft (30.5 m)
 500 ft (152 m)
 1000 ft (305 m)
 Bulk, cut to length
 (Minimums may apply)

24 AWG (0.22 mm²)

Stranding: 7/32 (7 x 0.20 mm)
 Insulation thickness: 0.010 (0.25 mm)

Part No.	Conductors	Nominal Diameter		Jacket Thickness	
		Inch	mm	Inch	mm
M5500	5	0.274	6.96	0.063	1.60
M5501	7	0.288	7.32	0.063	1.60
M5502	12	0.338	8.59	0.063	1.60
M5503	15	0.357	9.07	0.063	1.60
M5504	19	0.375	9.53	0.063	1.60
M5505	27	0.426	10.82	0.063	1.60
M5506	37	0.463	11.76	0.063	1.60
M5507	48	0.514	13.06	0.063	1.60
M5508	60	0.551	14.00	0.063	1.60

Mutual capacitance: 32 pF/ft (105 pF/m)
 Ground capacitance: 58 pF/ft (190 pF/m)

22 AWG (0.35 mm²)

Stranding: 7/30 (7 x 0.25 mm)
 Insulation thickness: 0.010 (0.25 mm)

Part No.	Conductors	Nominal Diameter		Jacket Thickness	
		Inch	mm	Inch	mm
M5509	5	0.291	7.39	0.063	1.60
M5510	7	0.306	7.77	0.063	1.60
M5511	12	0.363	9.22	0.063	1.60
M5512	15	0.385	9.78	0.063	1.60
M5513	19	0.405	10.29	0.063	1.60
M5514	27	0.463	11.76	0.063	1.60
M5515	37	0.505	12.83	0.063	1.60
M5516	48	0.563	14.30	0.063	1.60
M5517	60	0.605	15.37	0.063	1.60

Mutual capacitance: 36 pF/ft (118.1 pF/m)
 Ground capacitance: 65 pF/ft (213.3 pF/m)

20 AWG (0.56 mm²)

Stranding: 7/28 (7 x 0.32 mm)
 Insulation thickness: 0.010 (0.25 mm)

Part No.	Conductors	Nominal Diameter		Jacket Thickness	
		Inch	mm	Inch	mm
M5518	5	0.312	7.92	0.063	1.60
M5519	7	0.330	8.38	0.063	1.60
M5520	12	0.396	10.06	0.063	1.60
M5521	15	0.421	10.69	0.063	1.60
M5522	19	0.445	11.30	0.063	1.60
M5523	27	0.512	13.00	0.063	1.60
M5524	37	0.561	14.25	0.063	1.60
M5525	48	0.628	15.95	0.063	1.60
M5526	60	0.683	17.35	0.063	1.60

Mutual capacitance: 40 pF/ft (131.2 pF/m)
 Ground capacitance: 72 pF/ft (236.2 pF/m)



Manhattan™ Computer Cable

300 V Foil/Braid Shield, Low Capacitance, Multiconductor, FPE, PVC

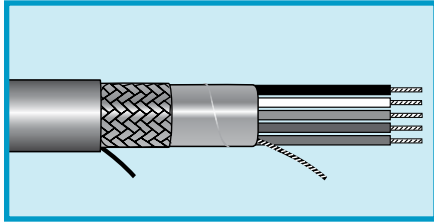

UL AWM 2919 (30 V)
UL CM VW-1
CSA CM FT4

Applications

- RS-232, RS-422
- Modems
- Multiplexers
- Serial data interfaces

Operating Temperature

- -20°C to +80°C (AWM)
- -20°C to +75°C (CM)

Conductor Color Coding

- See table

Materials

- Stranded tinned copper conductors
- Foam polyethylene insulation
- Foil + braid shield
 Aluminum/polyester foil shield,
 25% overlap min.
 Foil facing outward
 Stranded tinned copper drain
 wire equal in size to conductor
 Tinned copper braid,
 65% coverage
- Slate PVC jacket

Availability

100 ft (30.5 m)
 500 ft (152 m)
 1000 ft (305 m)
 Bulk, cut to length
 (Minimums may apply)

24 AWG (0.22 mm²)

Stranding: 7/32 (7 x 0.20 mm)
 Insulation thickness: 0.016 (0.41 mm)

Part No.	Conductors	Nominal Diameter		Jacket Thickness		Color Code
		Inch	mm	Inch	mm	
M2456	3	0.217	5.51	0.035	0.89	O
M2457	4	0.231	5.87	0.035	0.89	O
M2458	5	0.248	6.30	0.035	0.89	O
M2459	6	0.265	6.73	0.035	0.89	O
M2460	7	0.265	6.73	0.035	0.89	O
M2461	8	0.282	7.16	0.035	0.89	O
M2462	9	0.300	7.62	0.035	0.89	O
M2463	10	0.320	8.13	0.035	0.89	O
M2465	15	0.353	8.97	0.035	0.89	F
M2467	25	0.432	10.97	0.035	0.89	F
M2470	37	0.488	12.40	0.035	0.89	F

Mutual capacitance: 11.9 pF/ft (39 pF/m)
 Ground capacitance: 21.4 pF/ft (70.2 pF/m)



Manhattan™ Computer Cable

300 V Foil/Braid Shield, Multiconductor, PVC, PVC

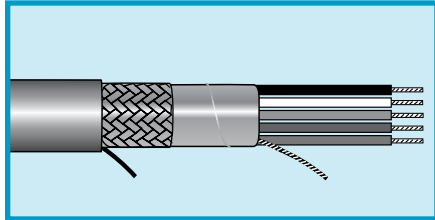

UL AWM 2464
UL CMG
CSA CMG FT4

Applications

- Computer and control

Operating Temperature

- -20°C to +80°C (AWM)
- -20°C to +75°C (CMG)

Conductor Color Coding

- Chart D (page 531)

Materials

- Stranded tinned copper conductors
- PVC insulation
- Foil + braid shield
 Aluminum/polyester foil shield,
 25% overlap min.
 Foil facing outward
 Stranded tinned copper drain
 wire equal in size to conductor
 Tinned copper braid,
 70% coverage
- Slate PVC jacket

Availability

100 ft (30.5 m)
 500 ft (152 m)
 1000 ft (305 m)
 Bulk, cut to length
 (Minimums may apply)



20 AWG (0.56 mm²)

Stranding: 7/28 (7 x 0.32 mm)
 Insulation thickness: 0.016 (0.41 mm)

Part No.	Conductors	Nominal Diameter		Jacket Thickness	
		Inch	mm	Inch	mm
M5360	2	0.233	5.92	0.032	0.81
M5361	3	0.241	6.12	0.032	0.81
M5362	4	0.262	6.65	0.032	0.81
M5364	6	0.304	7.72	0.032	0.81
M5365	8	0.326	8.28	0.032	0.81
M5366	10	0.373	9.47	0.032	0.81
M5368	15	0.415	10.54	0.032	0.81
M5370	20	0.459	11.66	0.032	0.81
M5372	25	0.513	13.03	0.032	0.81
M5375	40	0.653	16.59	0.053	1.35
M5377	50	0.713	18.11	0.053	1.35

18 AWG (0.81 mm²)

Stranding: 16/30 (16 x 0.25 mm)
 Insulation thickness: 0.016 (0.41 mm)

Part No.	Conductors	Nominal Diameter		Jacket Thickness	
		Inch	mm	Inch	mm
M5390	2	0.251	6.38	0.032	0.81
M5391	3	0.263	6.68	0.032	0.81
M5392*	2	0.251	6.38	0.032	0.81
M5393*	3	0.263	6.68	0.032	0.81
M5394	4	0.284	7.21	0.032	0.81
M5396	6	0.328	8.33	0.032	0.81
M5397	8	0.356	9.04	0.032	0.81
M5398	10	0.409	10.39	0.032	0.81
M5400	15	0.456	11.58	0.032	0.81
M5402	20	0.507	12.88	0.032	0.81
M5404	25	0.609	15.47	0.053	1.35
M5406	30	0.648	16.46	0.053	1.35

*Conductor color coding: 1 Brown, 2 Blue, 3 Green/Yellow.

16 AWG (1.32 mm²)

Stranding: 19/0.0117 (19 x 0.30 mm)
 Insulation thickness: 0.016 (0.41 mm)

Part No.	Conductors	Nominal Diameter		Jacket Thickness	
		Inch	mm	Inch	mm
M5420	2	0.275	6.99	0.032	0.81
M5421	3	0.289	7.34	0.032	0.81
M5422*	2	0.275	6.99	0.032	0.81
M5423*	3	0.289	7.34	0.032	0.81
M5424	4	0.313	7.95	0.032	0.81
M5426	6	0.367	9.32	0.032	0.81
M5428	8	0.396	10.06	0.032	0.81
M5430	10	0.457	11.61	0.032	0.81
M5432	15	0.511	12.98	0.032	0.81
M5434	20	0.611	15.52	0.053	1.35
M5436	25	0.687	17.45	0.053	1.35

*Conductor color coding: 1 Brown, 2 Blue, 3 Green/Yellow.

Manhattan™ Computer Cable

300 V Foil Shield, Multipair, PVC, PVC

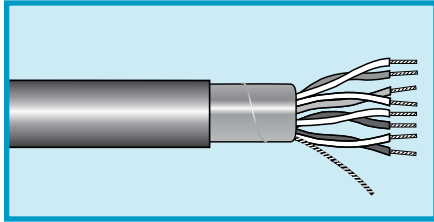

UL AWM 2464
UL CMG
CSA CMG FT4

Applications

- Modems
- Multiplexers
- General data interfaces

Operating Temperature

- -20°C to +80°C (AWM)
- -20°C to +75°C (CMG)

Conductor Color Coding

- Chart A (page 528)

Materials

- Solid or stranded tinned copper conductors
- PVC insulation
- Aluminum/polyester foil shield, 25% overlap min.
Foil facing inward
- Stranded tinned copper drain wire equal in size to conductor
- Slate PVC jacket

Availability

100 ft (30.5 m)
 500 ft (152 m)
 1000 ft (305 m)
 Bulk, cut to length
 (Minimums may apply)

22 AWG (0.35 mm ²)					
Stranding: Solid Insulation thickness: 0.010 (0.25 mm)					
Part No.	Pairs	Nominal Diameter		Jacket Thickness	
		Inch	mm	Inch	mm
M3191	51	0.710	18.03	0.050	1.27
M3192	102	1.120	28.45	0.085	2.16

20 AWG (0.56 mm ²)					
Stranding: 7/28 (7 x 0.32 mm) Insulation thickness: 0.016 (0.41 mm)					
Part No.	Pairs	Nominal Diameter		Jacket Thickness	
		Inch	mm	Inch	mm
M4785	2	0.301	7.65	0.032	0.81
M4786	3	0.319	8.10	0.032	0.81
M4789	12	0.548	13.92	0.032	0.81
M4791	19	0.688	17.48	0.053	1.35

18 AWG (0.81 mm ²)					
Stranding: 16/30 (16 x 0.25 mm) Insulation thickness: 0.016 (0.41 mm)					
Part No.	Pairs	Nominal Diameter		Jacket Thickness	
		Inch	mm	Inch	mm
M4799	2	0.330	8.38	0.032	0.81
M4793	3	0.350	8.89	0.032	0.81
M4794	6	0.462	11.73	0.032	0.81



Manhattan™ Computer Cable

300 V Foil Shield, Multipair, SR-PVC or PP, PVC

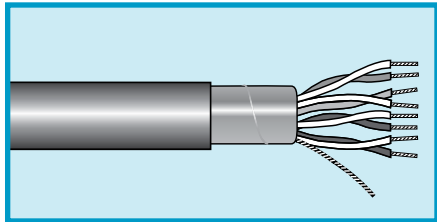

UL AWM 2464
UL CMG
CSA CMG FT4

Applications

- RS-232
- Modems
- Multiplexers
- Serial data interfaces

Operating Temperature

- -20°C to +80°C (AWM)
- -20°C to +75°C (CMG)

Conductor Color Coding

- See tables

Materials

- Solid or stranded tinned copper conductors
- Semirigid PVC or polypropylene insulation
- Aluminum/polyester foil shield, 25% overlap min.
Foil facing inward
Stranded tinned copper drain wire equal in size to conductor
- Slate PVC jacket

Availability

100 ft (30.5 m)
 500 ft (152 m)
 1000 ft (305 m)
 Bulk, cut to length
 (Minimums may apply)

SR-PVC Insulation

24 AWG (0.22 mm²)

Stranding: 7/32 (7 x 0.20 mm)
 Insulation thickness: 0.010 (0.25 mm)
 Color Code K

Part No.	Pairs	Nominal Diameter		Jacket Thickness	
		Inch	mm	Inch	mm
M13190	1	0.159	4.04	0.032	0.81
M13191	2	0.215	5.46	0.032	0.81
M13192	3	0.227	5.77	0.032	0.81
M13193	4	0.246	6.25	0.032	0.81
M13194	5	0.267	6.78	0.032	0.81
M13195	6	0.289	7.34	0.032	0.81
M13196	7	0.289	7.34	0.032	0.81
M13197	8	0.311	7.90	0.032	0.81
M13198	9	0.334	8.48	0.032	0.81
M13199	10	0.360	9.14	0.032	0.81
M4758*	11	0.360	9.14	0.032	0.81
M13200	15	0.402	10.21	0.032	0.81
M3189	19	0.432	10.97	0.032	0.81
M13201	25	0.510	12.95	0.035	0.89
M4761*	27	0.515	13.08	0.032	0.89
M13202**	50	0.666	16.92	0.035	0.89

*Color code Chart B (page 528)

**Color code Chart A1 (page 528)

SR-PVC Insulation

22 AWG (0.35 mm²)

Stranding: 7/30 (7 x 0.25 mm)
 Insulation thickness: 0.010 (0.25 mm)
 Color Code B

Part No.	Pairs	Nominal Diameter		Jacket Thickness	
		Inch	mm	Inch	mm
M4770	2	0.235	5.97	0.032	0.81
M4771	3	0.248	6.30	0.032	0.81
M4772	4	0.269	6.83	0.032	0.81
M4773	5	0.293	7.44	0.032	0.81
M4774	6	0.318	8.08	0.032	0.81
M4775	9	0.369	9.37	0.032	0.81
M4776	11	0.399	10.13	0.032	0.81
M4777	15	0.448	11.38	0.032	0.81
M4778	19	0.481	12.22	0.032	0.81
M4779	27	0.618	15.70	0.053	1.35

Polypropylene Insulation

22 AWG (0.35 mm²)

Stranding: Solid
 Insulation thickness: 0.008 (0.20 mm)
 Color Code K

Part No.	Pairs	Nominal Diameter		Jacket Thickness	
		Inch	mm	Inch	mm
M3190	38	0.610	15.49	0.045	1.14



Manhattan™ Computer Cable

300 V Foil/Braid Shield, Multipair, SR-PVC, PVC

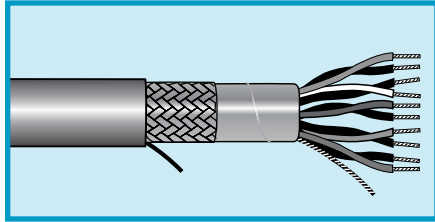

UL AWM 1061
UL AWM 2343
UL CMG
CSA CMG FT4

Applications

- Control, signal, and data transmission computers
- Industrial and electronic equipment

Operating Temperature

- -20°C to +80°C (AWM)
- -20°C to +75°C (CMG)

Conductor Color Coding

- Chart B (page 528)

Materials

- Stranded tinned copper conductors
- Semirigid PVC insulation
- Aluminum/polyester foil shield, 25% overlap min.
Foil facing outward
- Stranded tinned copper drain wire equal in size to conductor
- Tinned copper braid, 70% coverage
- Slate PVC jacket

Availability

100 ft (30.5 m)
 500 ft (152 m)
 1000 ft (305 m)
 Bulk, cut to length
 (Minimums may apply)

24 AWG (0.22 mm²)

Stranding: 7/32 (7 x 0.20 mm)
 Insulation thickness: 0.010 (0.25 mm)

Part No.	Pairs	Nominal Diameter		Jacket Thickness	
		Inch	mm	Inch	mm
M5650	5	0.351	8.92	0.063	1.60
M5651	7	0.373	9.47	0.063	1.60
M5652	12	0.455	11.56	0.063	1.60
M5653	15	0.486	12.34	0.063	1.60
M5654	19	0.516	13.11	0.063	1.60
M5655	27	0.599	15.21	0.063	1.60
M5656	37	0.666	16.92	0.063	1.60

Mutual capacitance: 23.1 pF/ft (75.8 pF/m)
 Ground capacitance: 42 pF/ft (137.8 pF/m)

Part No. M5650
 Mutual capacitance: 25 pF/ft (82 pF/m)
 Ground capacitance: 45 pF/ft (147.6 pF/m)

22 AWG (0.35 mm²)

Stranding: 7/30 (7 x 0.25 mm)
 Insulation thickness: 0.010 (0.25 mm)

Part No.	Pairs	Nominal Diameter		Jacket Thickness	
		Inch	mm	Inch	mm
M5660	5	0.377	9.58	0.063	1.60
M5661	7	0.402	10.21	0.063	1.60
M5662	12	0.496	12.60	0.063	1.60
M5665	27	0.666	16.92	0.063	1.60
M5666	37	0.735	18.67	0.063	1.60

Ground capacitance: 49 pF/ft (160.8 pF/m)

20 AWG (0.56 mm²)

Stranding: 7/28 (7 x 0.32 mm)
 Insulation thickness: 0.010 (0.25 mm)

Part No.	Pairs	Nominal Diameter		Jacket Thickness	
		Inch	mm	Inch	Mm
M5670	5	0.413	10.49	0.063	1.60
M5671	7	0.442	11.23	0.063	1.60
M5673	15	0.592	15.04	0.063	1.60
M5674	19	0.631	16.03	0.063	1.60
M5675	27	0.746	18.95	0.063	1.60

Mutual capacitance: 27 pF/ft (88.6 pF/m)
 Ground capacitance: 49 pF/ft (160.8 pF/m)

Part No. M5670
 Mutual capacitance: 29 pF/ft (95.1 pF/m)
 Ground capacitance: 52 pF/ft (170.6 pF/m)



Manhattan™ Computer Cable

300 V Foil Shield, Low Capacitance, 100 ohm, Multipair, FPP, PVC

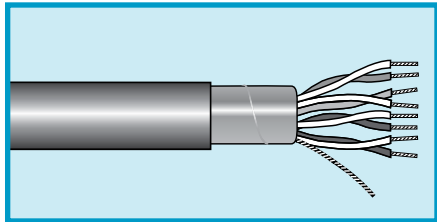

UL AWM 2493
UL CM
CSA CM FT4

Applications

- RS-232
- RS-422

Operating Temperature

- -20°C to +75°C (CM)
- -20°C to +60°C (AWM)

Conductor Color Coding

- Chart K (page 529)

Materials

- Stranded tinned copper conductors
- Foam polypropylene insulation
- Aluminum/polyester foil shield, 25% overlap min.
Foil facing inward
- Stranded tinned copper drain wire equal in size to conductor
- Slate PVC jacket

Availability

100 ft (30.5 m)
 500 ft (152 m)
 1000 ft (305 m)
 Bulk, cut to length
 (Minimums may apply)

24 AWG (0.22 mm ²)					
Stranding: 7/32 (7 x 0.20 mm)					
Insulation thickness: 0.0185 (0.47 mm)					
Part No.	Pairs	Nominal Diameter		Jacket Thickness	
		Inch	mm	Inch	mm
M39249	2	0.323	8.20	0.048	1.22
M39250	3	0.340	8.64	0.048	1.22
M39251	4	0.369	9.37	0.048	1.22
M39252	6	0.436	11.07	0.048	1.22
M39254	9	0.506	12.85	0.048	1.22
M39256	11	0.580	14.73	0.065	1.65
M39257	12	0.597	15.16	0.065	1.65
M39259	15	0.646	16.41	0.065	1.65
M39260	17	0.682	17.32	0.065	1.65
M39262	19	0.693	17.60	0.065	1.65
M39268	27	0.821	20.85	0.065	1.65

Mutual capacitance: 12.5 pF/ft (41 pF/m)
 Ground capacitance: 23 pF/ft (75.5 pF/m)

Part No. 39256
 Mutual capacitance: 11.9 pF/ft (39 pF/m)
 Ground capacitance: 21.4 pF/ft (70.2 pF/m)



Manhattan™ Computer Cable

300 V Foil/Braid Shield, Multipair, FPP, PVC

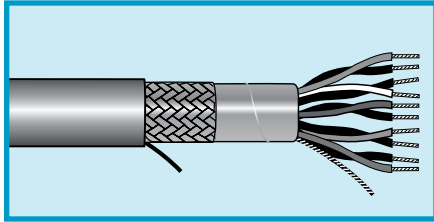

UL AWM 2919 (30 V)
UL CM
CSA CM

Applications

- RS-422
- Modems
- Multiplexers

Operating Temperature

- -20°C to +80°C (AWM)
- -20°C to +75°C (CM)

Conductor Color Coding

- Chart M (page 530)

Materials

- Stranded tinned copper conductors
- Foam polypropylene insulation
- Foil + braid shield
 Aluminum/polyester foil shield,
 25% overlap min.
 Foil facing outward
- Stranded tinned copper drain
 wire equal in size to conductor
- Tinned copper braid,
 65% coverage
- Slate PVC jacket

Availability

100 ft (30.5 m)
 500 ft (152 m)
 1000 ft (305 m)
 Bulk, cut to length
 (Minimums may apply)

28 AWG (0.09 mm²)

Stranding: 7/36 (7 x 0.13 mm)
 Insulation thickness: 0.0145 (0.37 mm)

Part No.	Pairs	Nominal Diameter		Jacket Thickness	
		Inch	mm	Inch	mm
M2487	2	0.240	6.10	0.035	0.89
M2488	3	0.252	6.40	0.035	0.89
M2489	4	0.271	6.88	0.035	0.89
M2490	5	0.292	7.42	0.035	0.89
M2492	7	0.314	7.98	0.035	0.89
M2493	8	0.336	8.53	0.035	0.89
M2494	10	0.385	9.78	0.035	0.89
M2495*	12.5	0.395	10.03	0.035	0.89
M2496	15	0.427	10.85	0.035	0.89
M2497	18	0.457	11.61	0.035	0.89
M2498	25	0.555	14.10	0.048	1.22

Mutual capacitance: 11 pF/ft (36.1 pF/m)
 Ground capacitance: 20 pF/ft (65.6 pF/m)

*Discrete conductor is polyethylene insulated.

24 AWG (0.22 mm²)

Stranding: 7/32 (7 x 0.20 mm)
 Insulation thickness: 0.0125 (0.32 mm)

Part No.	Pairs	Nominal Diameter		Jacket Thickness	
		Inch	mm	Inch	mm
M3420	2	0.257	6.53	0.035	0.89
M3421	3	0.269	6.83	0.035	0.89
M3422	4	0.290	7.37	0.035	0.89
M3423	5	0.314	7.98	0.035	0.89
M3424	6	0.338	8.59	0.035	0.89
M3425	7	0.338	8.59	0.035	0.89
M3426	8	0.363	9.22	0.035	0.89
M3427	10	0.417	10.59	0.035	0.89
M3428*	12.5	0.429	10.90	0.035	0.89
M3429	15	0.475	12.07	0.040	1.02
M3430	18	0.524	13.31	0.048	1.22
M3431	25	0.608	15.44	0.050	1.27

Mutual capacitance: 12.5 pF/ft (41 pF/m)
 Ground capacitance: 22 pF/ft (72.2 pF/m)

*Discrete conductor is polyethylene insulated.



Manhattan™ Computer Cable

300 V Foil/Braid Shield, Low Capacitance, Multipair, FPP, PVC

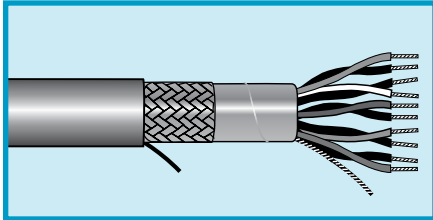

UL AWM 2343
UL CM
CSA CM

Applications

- RS-422
- Modems
- Multiplexers

Operating Temperature

- -20°C to +75°C (AWM)
- -20°C to +75°C (CM)

Conductor Color Coding

- Chart K (page 529)

Materials

- Stranded tinned copper conductors
- Foam polypropylene insulation
- Foil + braid shield
 Aluminum/polyester foil shield,
 25% overlap min.
 Foil facing outward
 Stranded tinned copper drain
 wire equal in size to conductor
 Tinned copper braid,
 65% coverage
- Slate PVC jacket

Availability

100 ft (30.5 m)
 500 ft (152 m)
 1000 ft (305 m)
 Bulk, cut to length
 (Minimums may apply)

24 AWG (0.22 mm²)

Stranding: 7/32 (7 x 0.20 mm)
 Insulation thickness: 0.0185 (0.47 mm)

Part No.	Pairs	Nominal Diameter		Jacket Thickness	
		Inch	mm	Inch	mm
M3475	2	0.346	8.79	0.048	1.22
M3476	3	0.363	9.22	0.048	1.22
M3477	4	0.392	9.96	0.048	1.22
M3478	5	0.425	10.80	0.048	1.22
M3479	6	0.459	11.66	0.048	1.22
M3480	7	0.459	11.66	0.048	1.22
M3481	8	0.494	12.55	0.048	1.22
M3482	10	0.603	15.32	0.065	1.65
M3483	15	0.669	16.99	0.065	1.65
M3484	18	0.716	18.19	0.065	1.65
M3485	25	0.832	21.13	0.065	1.65

Mutual capacitance: 12.5 pF/ft (41 pF/m)
 Ground capacitance: 23 pF/ft (23 pF/m)

Part No. M3484 and 3485:
 Mutual capacitance: 11.9 pF/ft (39 pF/m)
 Ground capacitance: 21.4 pF/ft (21.4 pF/m)



Manhattan™ Computer Cable

300 V Foil/Braid Shield, Low Capacitance, 100 Ohm, Multipair, PE, PVC

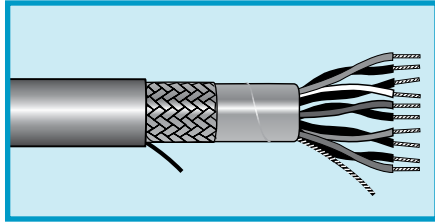

UL AWM 2960 (30 V)
UL 2919 (30 V)
UL CM
CSA CM

Applications

- RS-422
- Modems
- Multiplexers

Operating Temperature

- -20°C to +80°C (AWM 2919)
- -20°C to +75°C (CM)
- -20°C to +60°C (AWM 2960)

Conductor Color Coding

- See tables

Materials

- Stranded tinned copper conductors
- Polyethylene insulation
- Foil + braid shield
 Aluminum/polyester foil shield, 25% overlap min.
 Foil facing outward
- Stranded tinned copper drain wire equal in size to conductor
- Tinned copper braid, 90% coverage (65% where noted)
- Slate PVC jacket

Availability

100 ft (30.5 m)
 500 ft (152 m)
 1000 ft (305 m)
 Bulk, cut to length
 (Minimums may apply)

UL AWM 2960, CM

28 AWG (0.08 mm²)

Stranding: 7/36 (7 x 0.12 mm)
 Insulation thickness: 0.010 (0.25 mm)
 Color Code K

Part No.	Pairs	Nominal Diameter		Jacket Thickness	
		Inch	mm	Inch	mm
M3970	2	0.205	5.21	0.032	0.81
M3971	3	0.214	5.44	0.032	0.81
M3972	4	0.229	5.82	0.032	0.81
M3973	5	0.246	6.25	0.032	0.81
M3974	7	0.263	6.68	0.032	0.81
M3975	9	0.299	7.59	0.032	0.81
M3977	12	0.329	8.36	0.032	0.81
M3931	13	0.335	8.51	0.032	0.81
M3978	18	0.377	9.58	0.032	0.81
M3979	25	0.440	11.18	0.032	0.81
M3932	31	0.470	11.94	0.032	0.81

Mutual capacitance: 15.5 pF/ft (50.9 pF/m)
 Ground capacitance: 27.5 pF/ft (90.2 pF/m)

UL AWM 2919, CM

24 AWG (0.22 mm²)

Stranding: 7/32 (7 x 0.20 mm)
 Insulation thickness: 0.016 (0.25 mm)
 Color Code M

Part No.	Pairs	Nominal Diameter		Jacket Thickness	
		Inch	mm	Inch	mm
M3993 [†]	1	0.208	5.28	0.035	0.89
M3980*	2	0.274	6.96	0.032	0.81
M3990 [†]	2	0.280	7.11	0.035	0.89
M3981*	3	0.288	7.32	0.032	0.81
M3991 [†]	3	0.294	7.47	0.035	0.89
M3982*	4	0.312	7.92	0.032	0.81
M3992 [†]	4	0.318	8.08	0.035	0.89
M3983*	5	0.339	8.61	0.032	0.81
M3940*	6	0.367	9.32	0.032	0.81
M3984*	7	0.367	9.32	0.032	0.81
M3985*	9	0.424	10.77	0.032	0.81
M3986*	10	0.457	11.61	0.032	0.81
M3987*	12	0.482	12.24	0.037	0.94
M3988*	18	0.560	14.22	0.047	1.19
M3989*	25	0.671	17.04	0.047	1.19

Mutual capacitance: 15.5 pF/ft (50.9 pF/m)
 Ground capacitance: 27.5 pF/ft (90.2 pF/m)

[†]120-ohm impedance
 Mutual capacitance: 12.8 pF/ft (42 pF/m)
 Ground capacitance: 23 pF/ft (75 pF/m)

*65% braid coverage.



Manhattan™ Computer Cable

300 V Foil/Braid Shield, Multipair, SR-PVC, PVC

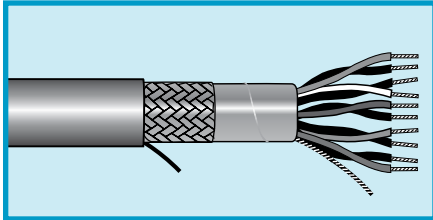

UL AWM 2464
UL CMG
CSA CMG FT4

Applications

- RS-422
- Modems
- Multiplexers

Operating Temperature

- -20°C to +80°C (AWM)
- -20°C to +75°C (CMG)

Conductor Color Coding

- See tables

Materials

- Stranded tinned copper conductors
- Semirigid PVC insulation
- Foil + braid shield
 Aluminum/polyester foil shield,
 25% overlap min.
 Foil facing outward
 Stranded tinned copper drain
 wire, 24 AWG (0.22 mm²),
 7/32 (7 x 0.20 mm) stranding
 Tinned copper braid,
 65% coverage
- Slate PVC jacket

Availability

100 ft (30.5 m)
 500 ft (152 m)
 1000 ft (305 m)
 Bulk, cut to length
 (Minimums may apply)

24 AWG (0.22 mm²)

Stranding: 7/32 (7 x 0.20 mm)
 Insulation thickness: 0.010 (0.25 mm)
 Color Code M

Part No.	Pairs	Nominal Diameter		Jacket Thickness		Capacitance			
		Inch	mm	Inch	mm	Mutual		Ground	
						pF/ft	pF/m	pF/ft	pF/m
M3446	2	0.234	5.94	0.032	0.81	28	92	50	164
M3447	3	0.246	6.25	0.032	0.81	25	82	45	147.6
M3448	4	0.265	6.73	0.032	0.81	25	82	45	147.6
M3449	5	0.286	7.26	0.032	0.81	25	82	45	147.6
M3450	6	0.308	7.82	0.032	0.81	23.1	75.8	42	137.8
M3451	7	0.308	7.82	0.032	0.81	23.1	75.8	42	137.8
M3452	8	0.330	8.38	0.032	0.81	23.1	75.8	42	137.8
M3453	10	0.379	9.63	0.032	0.81	23.1	75.8	42	137.8
M3454	12	0.389	9.88	0.032	0.81	23.1	75.8	42	137.8
M3455	15	0.421	10.69	0.032	0.81	23.1	75.8	42	137.8

22 AWG (0.35 mm²)

Stranding: 7/30 (7 x 0.25 mm)
 Insulation thickness: 0.010 (0.25 mm)
 Color Code A

Part No.	Pairs	Nominal Diameter		Jacket Thickness		Capacitance			
		Inch	mm	Inch	mm	Mutual		Ground	
						pF/ft	pF/m	pF/ft	pF/m
M3433	2	0.254	6.45	0.032	0.81	31	101.7	56	183.7
M3434	3	0.267	6.78	0.032	0.81	27	88.6	49	160.8
M3435	4	0.288	7.32	0.032	0.81	27	88.6	49	160.8
M3436	5	0.312	7.92	0.032	0.81	27	88.6	49	160.8
M3437	6	0.337	8.56	0.032	0.81	27	88.6	49	160.8
M3438	7	0.337	8.56	0.032	0.81	24.9	81.7	45	147.6
M3439	8	0.363	9.22	0.032	0.81	24.9	81.7	45	147.6
M3440	10	0.418	10.62	0.032	0.81	24.9	81.7	45	147.6
M3441	12	0.430	10.92	0.032	0.81	24.9	81.7	45	147.6
M3442	15	0.473	12.01	0.035	0.81	24.9	81.7	45	147.6
M3443	18	0.506	12.85	0.035	0.81	24.9	81.7	45	147.6
M3444	25	0.588	14.94	0.035	0.81	24.9	81.7	45	147.6



Manhattan™ Coaxial Cable

Coaxial and Twinax Cable

For a complete range of 50, 75, 93, and 100 ohm coaxial and twinaxial, we offer a wide range of insulations and jackets meeting the requirements of military specifications and regulatory agencies such as UL and CSA.

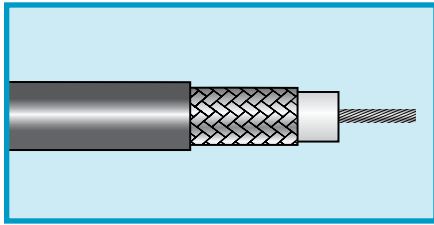

For broadcast-quality video transmission, our precision video cables use FEP dielectrics to achieve low capacitance, high velocities of propagation, and tight tolerances for maximum signal integrity.

Availability

- A. 100 ft (30.5 m)
- B. 500 ft (152 m)
- C. 500 ft (152 m) boxed
- D. 1000 ft (305 m)
- E. 1000 ft (305 m) boxed
- F. 2000 ft (610 m)
- G. Bulk, cut to length
(Minimums may apply)

50-Ohm Transmission and Computer Cables

RG-55B/U, RG-58/U, RG-58A/U, and RG-58C/U Coaxial Cables

Part No.	Center Conductor		Dielectric			Shield Material, Coverage	Jacket	
	AWG (mm ²)	Stranding (mm)	Material	Material	Dia., In. (mm)		Material	Dia., In. (mm)
9058	20 (0.52)	Solid	BC	PE	0.116 (2.95)	TC Braid, 80%	Black Type I PVC	0.195 (4.95)
9058A	20 (0.48)	19/0.0071 (19 x 0.18)	TC	PE	0.116 (2.95)	TC Braid, 95%	Black Type I PVC	0.195 (4.95)
9058AC	20 (0.48)	19/0.0071 (19 x 0.18)	TC	PE	0.116 (2.95)	TC Braid, 95%	Black Type I PVC	0.195 (4.95)
9058C	20 (0.48)	19/0.0072 (19 x 0.18)	TC	PE	0.116 (2.95)	TC Braid, 95%	Black Type IIA PVC	0.195 (4.95)
9058X	20 (0.52)	Solid	BC	PE	0.116 (2.95)	TC Braid, 95%	Black Type I PVC	0.195 (4.95)
9158S	20 (0.52)	Solid	BC	FEP	0.107 (2.72)	TC Braid, 95%	Black FEP	0.159 (4.04)
M4210	20 (0.62)	19/32 (19 x 0.20)	TC	Foam PE	0.116 (2.95)	TC Braid, 93%	Black or White Type I PVC	0.193 (4.90)
M4213	20 (0.48)	19/0.0072 (19 x 0.18)	TC	PE	0.116 (2.95)	TC Braid, 94%	Black Type IIA PVC	0.195 (4.95)
M4219	20 (0.48)	19/0.0071 (19 x 0.18)	TC	PE	0.117 (2.97)	TC Braid, 91%	Black Type I PVC	0.203 (5.16)
M44209	20 (0.52)	Solid	BC	FEP	0.107 (2.72)	TC Braid, 95%	White Plenum PVC	0.159 (4.04)
9848	18 (0.82)	Solid	BC	Foam PE	0.116 (2.95)	TC Braid, 95%	Black Type I PVC	0.195 (4.95)



Manhattan™ Coaxial Cable

50-Ohm Transmission and Computer Cables					
RG-55B/U, RG-58/U, RG-58A/U, and RG-58C/U Coaxial Cables					
Part No.	Nom. Impedance (Ω)	Vp (%)	Capacitance, pF/ft (pF/m)	Specifications	Availability
9058	53	66	28.5 (93.5)	UL AWM 1354 JAN-C-17A/RG-58/U	A, B, D
9058A	50	66	30.8 (101.1)	JAN-C-17A/RG-58A/U Type	A, B, C, D, E
9058AC	50	66	30.8 (101.1)	CL2 JAN-C-17A/RG-58A/U Type	A, B, D, E
9058C	50	66	30.8 (101.1)	MIL-DTL-17/28B RG 58C/U	A, B, D, E
9058X	53.5	66	28.5 (93.5)	UL AWM 1354 UL CL2 JAN-C-17A/RG-58/U	A, B, C, D, E
9158S	50	70	30 (98.4)	UL CL2P CSA CMP FT6 MIL-DTL-17/28 RG-58/U Type	B, D
M4210	52	76	26 (85.3)	UL AWM 1354 UL CM CSA CM JAN-C-17A/RG-58/U	A, B, D
M4213	50	66	30.8 (101.1)	MIL-DTL-17/28B RG-58C/U	A, B, D
M4219	50	66	30.8 (101.1)	UL CM CSA CM JAN-C-17A/RG-58A/U Type	A, B, D
M44209	53	69.5	26.4 (86.6)	UL CMP CSA CMP FT6 MIL-DTL-17/RG-58/U Type	A, B, D, G
9848	50	78	26 (85.3)	UL AWM 1354 MIL-DTL-17/28B RG-58/U Type	A, B, D, E



Manhattan™ Coaxial Cable

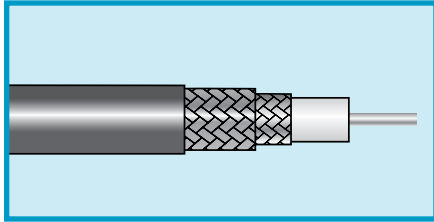

50-Ohm Transmission and Computer Cables

RG-55B/U Coaxial Cables

Part No.	Center Conductor		Dielectric			Shield Material, Coverage	Jacket	
	AWG (mm ²)	Stranding (mm)	Material	Material	Dia., In. (mm)		Material	Dia., In. (mm)
9055B	20 (0.52)	Solid	SPC	PE	0.116 (2.95)	Dbl TC Braid, 95%	Black PE	0.201 (5.11)

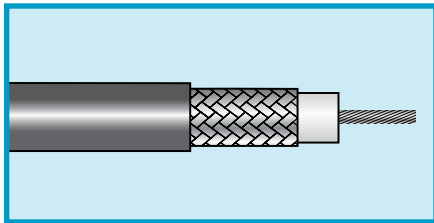

50-Ohm Transmission and Computer Cables

RG-8/U and RG-8A/U Type Coaxial Cables

Part No.	Center Conductor		Dielectric			Shield Material, Coverage	Jacket	
	AWG (mm ²)	Stranding (mm)	Material	Material	Dia., In. (mm)		Material	Dia., In. (mm)
9008	13 (2.90)	7/21 (7 x 0.72)	BC	PE	0.285 (7.24)	BC Braid, 94%	Black Type I PVC	0.405 (10.29)
M4201	13 (2.90)	7/21 (7 x 0.72)	BC	PE	0.285 (7.24)	BC Braid, 95%	Black Type IIA PVC	0.405 (10.29)
M4206	11 (4.60)	7/19 (7 x 0.91)	BC	Foam PE	0.285 (7.24)	BC Braid, 96%	Black PVC	0.403 (10.24)



Manhattan™ Coaxial Cable

50-Ohm Transmission and Computer Cables					
RG-55B/U Coaxial Cables					
Part No.	Nom. Impedance (Ω)	Vp (%)	Capacitance, pF/ft (pF/m)	Specifications	Availability
9055B	53.5	66	28.8 (94.5)	MIL-DTL-17D/26A RG-55B/U	A, B, D

50-Ohm Transmission and Computer Cables					
RG-8/U and RG-8A/U Type Coaxial Cables					
Part No.	Nom. Impedance (Ω)	Vp (%)	Capacitance, pF/ft (pF/m)	Specifications	Availability
9008	52	66	29.5 (96.8)	JAN-C-17A/RG-8/U	A, B, D
M4201	52	66	28.5 (93.5)	UL AWM 1354 UL CMX CSA CMX MIL-DTL-17D/3A RG-8A/U	A, B, D
M4206	50	78	26 (85.3)	UL AWM 1354 UL CM CSA CM MIL-DTL-17/RG-8/U Type	A, B, D



Manhattan™ Coaxial Cable

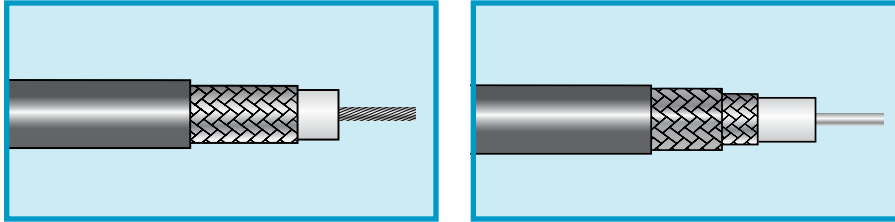

50-Ohm Transmission and Computer Cables

RG-142B/U, RG-174 Type, RG-178B/U, RG-188A/U, RG-196A/U, RG-213 Type, RG-214 Type, RG-217/U, RG-223/U, RG-316/U Coaxial Cables

Part No.	Center Conductor		Dielectric			Shield Material, Coverage	Jacket	
	AWG (mm ²)	Stranding (mm)	Material	Material	Dia., In. (mm)		Material	Dia., In. (mm)
9178B	30 (0.05)	7/38 (7 x 0.10)	SCW	PTFE	0.034 (0.86)	SPC Braid, 94%	Natural Tan FEP	0.071 (1.80)
9196A	30 (0.05)	7/38 (7 x 0.10)	SCW	PTFE	0.034 (0.86)	SPC Braid, 94%	Natural PTFE Tape	0.075 (1.91)
9174	26 (0.14)	7/34 (7 x 0.16)	BCW	PE	0.060 (1.52)	TC Braid, 85%	Black or Red Type I PVC	0.102 (2.59)
9188A	25 (0.16)	7/0.0067 (7 x 0.17)	SCW	PTFE	0.060 (1.52)	SPC Braid, 94%	White PTFE Tape	0.105 (2.67)
9316	25 (0.16)	7/0.0067 (7 x 0.17)	SCW	PTFE	0.060 (1.52)	SPC Braid, 94%	Natural Tan FEP	0.098 (2.49)
9223	19 (0.62)	Solid	SPC	PE	0.116 (2.95)	Dbl SPC Braid, 95%	Black Type IIA PVC	0.212 (5.38)
M4251	19 (0.69)	Solid	SCW	PTFE	0.116 (2.95)	Dbl SPC Braid, 95%	Natural Tan FEP	0.195 (4.95)
9213	13 (3.11)	7/0.0296 (7 x 0.75)	BC	PE	0.285 (7.24)	BC Braid, 96%	Black Type IIA PVC	0.405 (10.29)
9214	13 (3.11)	7/0.0296 (7 x 0.75)	SPC	PE	0.285 (7.34)	Dbl SPC Braid, 95%	Black Type IIA PVC	0.425 (10.80)
9217	10 (5.70)	Solid	BC	PE	0.370 (9.40)	Dbl BC Braid, 95%	Black Type IIA PVC	0.545 (13.84)



Manhattan™ Coaxial Cable

50-Ohm Transmission and Computer Cables					
RG-142B/U, RG-174 Type, RG-178B/U, RG-188A/U, RG-196A/U, RG-213 Type, RG-214 Type, RG-217/U, RG-223/U, RG-316/U Coaxial Cables					
Part No.	Nom. Impedance (Ω)	Vp (%)	Capacitance, pF/ft (pF/m)	Specifications	Availability
9178B	50	70	29.3 (96.1)	MIL-DTL-17/RG-178B/U	A, B, D, G
9196A	50	70	29.3 (96.1)	MIL-DTL-17/RG-196A/U	A, B, D, G
9174	50	66	30.8 (101.1)	UL AWM 1354 MIL-DTL-17D/119F RG-174/U	A, B, D
9188A	50	70	29.3 (96.1)	MIL-DTL-17/69B RG-188A/U	A, B, D, G
9316	50	70	29.3 (96.1)	AWM 1971 CSA CMX FT4 MIL-DTL-17 M17/113 RG-316	A, B, D, G
9223	50	66	30.8 (101.1)	MIL-DTL-17D/84B RG-223/U	A, B, D
M4251	50	70	29 (95.1)	MIL-DTL-17/RG-142B/U	A, B, D, G
9213	50	66	30.8 (101.1)	MIL-DTL-17/74A RG-213 Type	A, B, D
9214	50	66	30.8 (101.1)	AWM 1354 MIL-DTL-17/75D RG-214/U	A, B, D, G
9217	50	66	30.8 (101.1)	MIL-DTL-17D/78A RG-217/U	A, B, D, G



Manhattan™ Coaxial Cable

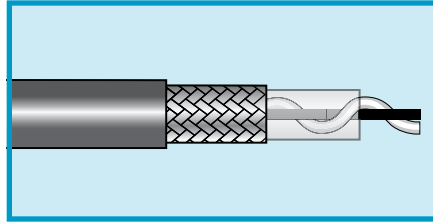
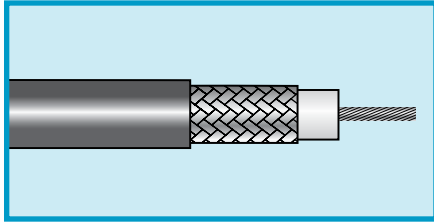

93-Ohm Coaxial Cables

RG-62A/U, RG-22B/U Coaxial Cables

Part No.	Center Conductor		Dielectric			Shield Material, Coverage	Jacket	
	AWG (mm ²)	Stranding (mm)	Material	Material	Dia., In. (mm)		Material	Dia., In. (mm)
9062A	22 (0.32)	Solid	BCW	Semisolid PE	0.146 (3.71)	BC Braid, 95%	Black Type IIA PVC	0.242 (6.15)
9062AC	22 (0.32)	Solid	BCW	Semisolid PE	0.146 (3.71)	BC Braid, 95%	Black Type IIA PVC*	0.242 (6.15)
M4276	22 (0.32)	Solid	BCW	Semisolid PE	0.146 (3.71)	BC Braid, 95%	Black Type IIA PVC	0.239 (6.07)
M44276	22 (0.32)	Solid	BCW	Semisolid FEP	0.142 (3.61)	BC Braid, 94%	White Plenum PVC	0.202 (5.13)
M44276F	22 (0.32)	Solid	BCW	Foam FEP	0.146 (3.71)	BC Braid, 94%	White Plenum PVC	0.204 (5.18)

*Also available in white, green, blue, orange, yellow, and slate.

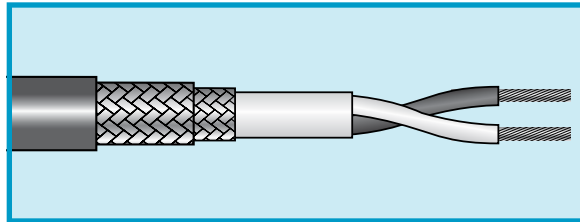
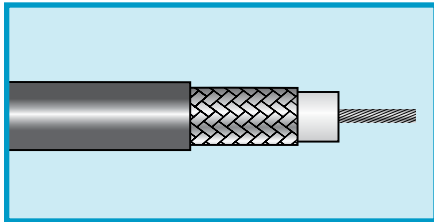

95-Ohm Coaxial Cables

RG-180B/U Coaxial, RG-22B/U Twinax Cables

Part No.	Center Conductor		Dielectric			Shield Material, Coverage	Jacket	
	AWG (mm ²)	Stranding (mm)	Material	Material	Dia., In. (mm)		Material	Dia., In. (mm)
9180B	30 (0.05)	7/38 (7 x 0.10)	SCW	PTFE	0.102 (2.59)	SPC Braid, 91%	Natural Tan FEP	0.141 (3.58)
M4203	18 (0.87)	7/0.0152 (7 x 0.39)	BC*	PE	0.090 (2.85)	Dbl TC Braid, 95%	Black Type IIA PVC	0.420 (10.67)

*For identification, one conductor includes a single tinned copper strand.



Manhattan™ Coaxial Cable

93-Ohm Coaxial Cables					
RG-62A/U, RG-22B/U Coaxial Cables					
Part No.	Nom. Impedance (Ω)	Vp (%)	Capacitance, pF/ft (pF/m)	Specifications	Availability
9062A	93	83	13.2 (43.3)	UL AWM 1478 MIL-DTL-17/30B RG-62A/U	A, B, D, E, F
9062AC	93	83	13.5 (44.3)	UL AWM 1478 UL CL2 CSA CMH MIL-DTL-17/30B RG-62A/U	A, B, D, E, F
M4276	93	84	13.5 (44.3)	UL AWM 1478 UL CL2 UL CM CSA CM MIL-DTL-17/RG-62A/U Type	A, B, D, G
M44276	93	85	12.8 (42)	UL CMP CSA CMP MIL-DTL-17/RG-62A/U Type	A, B, D, G
M44276F	93	85	12.5 (41)	UL CMP CSA CMP MIL-DTL-17/RG-62U Type	A, B, D, G

95-Ohm Coaxial Cables					
RG-180B/U Coaxial, RG-22B/U Twinax Cables					
Part No.	Nom. Impedance (Ω)	Vp (%)	Capacitance, pF/ft (pF/m)	Specifications	Availability
9180B	95	70	15.4 (50.5)	MIL-DTL-17/RG-180B/U	A, B, D, G
M4203	95	66	16 (52.5)	UL AWM 2498 MIL-DTL-17/RG-22B/U Type	A, B, D, G



Manhattan™ Coaxial Cable

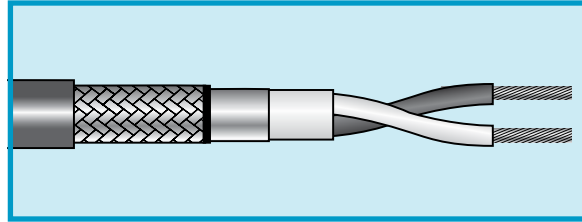
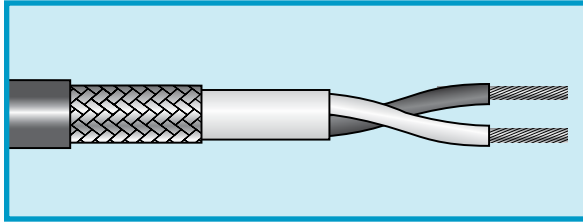

Twinax Cables								
78-Ohm Twinax Cables								
Part No.	Center Conductor			Dielectric		Shield Material, Coverage	Jacket	
	AWG (mm ²)	Stranding (mm)	Material	Material	Dia., In. (mm)		Material	Dia., In. (mm)
9888C	22 (0.35)	7/30 (7 x 0.25)	TC	White and Blue HDPE	0.056 (1.42)	TC Braid, 85%	Apple Smoke Slate PVC	0.184 (4.67)
9108	20 (0.56)	7/28 (7 x 0.32)	TC	Blue and Clear FEP	0.074 (1.88)	TC Braid, 95%	Blue FEP	0.198 (5.03)
M4154	20 (0.56)	7/28 (7 x 0.32)	TC	Blue and Clear PE	0.076 (1.93)	A/P Tape TC Braid, 55%	Blue PVC	0.238 (6.05)
M4220	20 (0.56)	7/28 (7 x 0.32)	TC*	Natural PE	0.079 (2.01)	TC Braid, 85%	Black Type II PVC	0.235 (5.97)

*For identification, one conductor includes a bare copper strand Type IIA.

Twinax Cables								
100-Ohm Twinax Cables								
Part No.	Center Conductor			Dielectric		Shield Material, Coverage	Jacket	
	AWG (mm ²)	Stranding (mm)	Material	Material	Dia., In. (mm)		Material	Dia., In. (mm)
9109	20 (0.56)	7/28 (7 x 0.32)	BC TC	FEP	0.072 (1.83)	TC Braid, 95%	Slate PVDF	0.252 (6.40)
9817	20 (0.56)	7/28 (7 x 0.32)	BC TC	PE	0.083 (2.11)	TC Braid, 85%	Black PVC	0.330 (8.38)
M4271	20 (0.56)	7/28 (7 x 0.32)	BC TC	PE	0.083 (2.11)	A/P/A Tape TC Braid, 85%	Black PVC	0.330 (8.38)

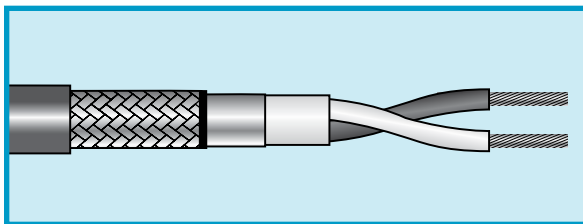

Twinax Cables								
124- and 150-Ohm Twinax Cables								
Part No.	Center Conductor			Dielectric		Shield Material, Coverage	Jacket	
	AWG (mm ²)	Stranding (mm)	Material	Material	Dia., In. (mm)		Material	Dia., In. (mm)
9823	22 (0.38)	19/34 (19 x 0.16)	TC	Black and Yellow Foam PE	0.120 (3.05)	A/P/A Tape	Black PVC	0.329 (8.36)
M4158	16 (1.31)	Solid	BC	Blue and Clear Foam PE	0.161 (4.09)	A/P/A Tape TC Braid, 90%	Black PVC	0.440 (11.18)



Manhattan™ Coaxial Cable

Twinax Cables					
78-Ohm Twinax Cables					
Part No.	Nom. Impedance (Ω)	Vp (%)	Capacitance, pF/ft (pF/m)	Specifications	Availability
9888C	78	66	19.7 (64.6)	UL AWM 2726 UL CM CSA CMG FT4	D, E
9108	78	69.5	18.4 (60.4)	UL CMP CSA CMP	B, D
M4154	78	66	19.7 (64.6)	UL AWM 2464 UL CM CSA CM	A, B, D, G
M4220	78	66	19.7 (64.6)	MIL-DTL-17/RG-108 Type	A, B, D, G

Twinax Cables					
100-Ohm Twinax Cables					
Part No.	Nom. Impedance (Ω)	Vp (%)	Capacitance, pF/ft (pF/m)	Specifications	Availability
9109	100	69	13.3 (43.6)	UL CMP UL CL2P CSA CMP	D
9817	100	66	14.5 (47.6)	UL AWM 2498	A, B, D
M4271	100	66	14.5 (47.6)	UL CMG UL CL2 CSA CMG	A, B, D, G

Twinax Cables					
124- and 150-Ohm Twinax Cables					
Part No.	Nom. Impedance (Ω)	Vp (%)	Capacitance, pF/ft (pF/m)	Specifications	Availability
9823	150	78	8.8 (28.9)	UL AWM 2668	A, B, D, G
M4158	124	78	10.9 (35.8)	UL AWM 2448 UL CMX CSA CMX	A, B, D, G



Manhattan™ Coaxial Cable

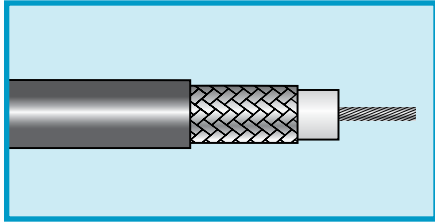

Miniature Coaxial Cables								
Part No.	Center Conductor		Dielectric			Shield Material, Coverage	Jacket	
	AWG (mm ²)	Stranding (mm)	Material	Material	Dia., In. (mm)		Material	Dia., In. (mm)
M4243	30 (0.05)	7/38 (7 x 0.10)	TC	Foam HDPE	0.058 (1.47)	TC Braid, 89%	Black PVC	0.097 (2.46)
M4242	28 (0.08)	Solid	TC	PP	0.023 (0.58)	TC Braid, 90%	Black PVC	0.054 (1.37)
M4244	27 (0.11)	7/35 (7 x 0.142)	BCW	PE	0.100 (2.54)	TC Braid, 93%	Black PVC	0.150 (3.81)



Manhattan™ Coaxial Cable

Miniature Coaxial Cables					
Part No.	Nom. Impedance (Ω)	Vp (%)	Capacitance, pF/ft (pF/m)	Specifications	Availability
M4243	75	78	17.3 (56.8)	UL AWM 1375	A, B, D, G
M4242	32	66	55.2 (181.1)	UL CMH CSA CMH	A, B, D, G
M4244	75	66	20.5 (67.3)	UL AWM 1354	A, B, D, G



Manhattan™ Coaxial Cable

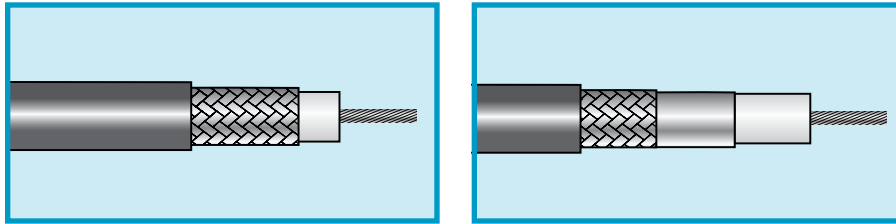

75-Ohm Video Cable								
RG-59/U, RG-59B/U Coaxial Cables								
Part No.	Center Conductor		Dielectric			Shield Material, Coverage	Jacket	
	AWG (mm ²)	Stranding (mm)	Material	Material	Dia., In. (mm)		Material	Dia., In. (mm)
9059B	23 (0.26)	Solid	BCW	PE	0.146 (3.71)	BC Braid, 94%	Black Type IIA PVC	0.242 (6.15)
9159	23 (0.26)	Solid	BCW	FEP	0.132 (3.35)	BC Braid, 95%	Black PVDF	0.190 (4.83)
9810	23 (0.26)	Solid	BC	PE	0.146 (3.71)	A/P/A Tape TC Braid, 95%	Black Type IIIA PE	0.220 (5.59)
M4223	23 (0.26)	Solid	BCW	PE	0.146 (3.71)	BC Braid, 94%	Black Type IIA PVC	0.241 (6.12)
9059	22 (0.32)	Solid	BCW	PE	0.146 (3.71)	BC Braid, 95%	Black, White, Slate Type I PVC	0.242 (6.15)
9059C	22 (0.32)	Solid	BCW	PE	0.146 (3.71)	BC Braid, 95%	Black, Red, Blue, Green, Slate Type I PVC	0.242 (6.15)
9830	22 (0.32)	Solid	BCW	PE	0.146 (3.71)	BC Braid, 85%	Black Type I PVC	0.242 (6.15)
M4212	22 (0.32)	Solid	BCW	Foam PE	0.146 (3.71)	BC Braid, 85%	Black Type I PVC	0.242 (6.15)
M4237	22 (0.35)	7/30 (7 x 0.25)	BC	Foam PE	0.146 (3.71)	BC Braid, 95%	Black Type I PVC	0.240 (6.10)
M44212F	20 (0.52)	Solid	BCW	Foam FEP	0.140 (3.56)	A/P/A Tape TC Braid, 94%	White Plenum PVC	0.202 (5.13)
9102	20 (0.52)	Solid	BCW	Foam FEP	0.140 (3.56)	A/P/A Tape TC Braid, 94%	Black PVDF	0.212 (5.38)



Manhattan™ Coaxial Cable

75-Ohm Video Cable					
RG-59/U, RG-59B/U Coaxial Cables					
Part No.	Nom. Impedance (Ω)	Vp (%)	Capacitance, pF/ft (pF/m)	Specifications	Availability
9059B	75	66	20.5 (67.3)	UL CL2X CSA CMH FT1 MIL-DTL-17D/29B RG-59B/U	A, B, C, D, E
9159	75	69.5	19.5 (64)	UL CL2P UL CMP CSA CMP FT6 MIL-DTL-17/RG-59B/U Type	D
9810	75	66	21 (68.9)	MIL-DTL-17/RG-59/U Type	A, D
M4223	75	66	20.5 (67.3)	UL AWM 1354 UL CMX CSA CMX MIL-DTL-17D/29B RG-59B/U	A, B, D
9059	73	66	21 (68.9)	UL AWM 1354 JAN-C-17A/RG-59/U	A, B, D
9059C	73	66	21 (68.9)	UL AWM 1354 UL CL2 CSA CMG FT4 JAN-C-17A /RG-59/U	A, B, C, D, E
9830	75	66	21.5 (70.5)	UL AWM 1354 UL CMX CSA CMX JAN-C-17A/RG-59/U	A, B, D
M4212	80	78	16.3 (53.5)	UL AWM 1354 UL CM CSA CM JAN-C-17A/RG-59/U	A, B, D
M4237	75	78	17.3 (56.8)	UL AWM 1354 UL CM CSA CM MIL-DTL-17/RG-59/U Type	A, B, D
M44212F	75	82	16.5 (54.1)	UL CMP UL CATVP CSA CMP FT6 MIL-DTL-17/RG-59/U Type	A, B, D, G
9102	75	82	16.5 (54.1)	UL CMP UL CL2P CSA CMP FT6 MIL-DTL-17/RG-59U Type	B, D



Manhattan™ Coaxial Cable

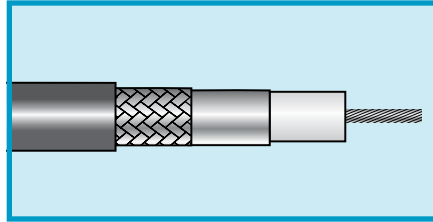
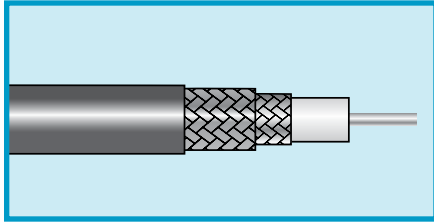

75-Ohm Video Cable

RG-6U Type, RG-6A/U Type

Part No.	Center Conductor		Dielectric			Shield Material, Coverage	Jacket	
	AWG (mm ²)	Stranding (mm)	Material	Material	Dia., In. (mm)		Material	Dia., In. (mm)
M4204	21 (0.41)	Solid	BCW	PE	0.185 (4.70)	Dbl BC Braid, 95%	Black PE	0.332 (8.43)
9104	18 (0.82)	Solid	BCW	Foam FEP	0.170 (4.32)	A/P Tape TC Braid, 95%	Black PVDF	0.232 (5.89)
M4182	18 (0.82)	Solid	BC	Foam PE	0.180 (4.57)	A/P/A Tape TC Braid, 60%	Black Type I PVC	0.270 (6.86)

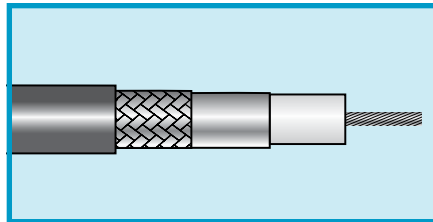
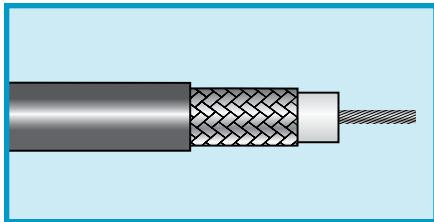

75-Ohm Video Cable

RG-11/U, RG-11/U Type, RG-11A/U

Part No.	Center Conductor		Dielectric			Shield Material, Coverage	Jacket	
	AWG (mm ²)	Stranding (mm)	Material	Material	Dia., In. (mm)		Material	Dia., In. (mm)
9011A	18 (0.89)	7/26 (7 x 0.40)	TC	PE	0.285 (7.24)	BC Braid, 95%	Black Type IIA PVC	0.405 (10.29)
M4207	18 (0.89)	7/26 (7 x 0.40)	TC	PE	0.285 (7.24)	BC Braid, 95%	Black Type I PVC	0.405 (10.29)
9105	14 (2.08)	Solid	BC	Foam FEP	0.274 (6.96)	A/P/A Tape TC Braid, 60%	Black FEP	0.346 (8.79)
M4208	14 (2.08)	Solid	BC	Foam PE	0.285 (7.24)	BC Braid, 95%	Black PE	0.405 (10.29)



Manhattan™ Coaxial Cable

75-Ohm Video Cable					
RG-6U Type, RG-6A/U Type					
Part No.	Nom. Impedance (Ω)	Vp (%)	Capacitance, pF/ft (pF/m)	Specifications	Availability
M4204	75	66	20.5 (67.3)	MIL-DTL-17/RG-6A/U Type	
9104	75	82	16.5 (54.1)	UL CMP UL CATVP CSA CMP FT6 MIL-DTL-17/RG-6U Type	B, D
M4182	75	82	16.2 (53.1)	UL AWM 1354 UL CM CSA CM MIL-DTL-17/ RG 6/U Type	A, B, D

75-Ohm Video Cable					
RG-11/U, RG-11/U Type, RG-11A/U					
Part No.	Nom. Impedance (Ω)	Vp (%)	Capacitance, pF/ft (pF/m)	Specifications	Availability
9011A	75	66	20.5 (67.3)	UL CL2X CSA CMH FT1 MIL-DTL-17D/6B RG 11A/U	A, B, D
M4207	75	66	20.5 (67.3)	UL CM CSA CM JAN-C-17A/ RG 11/U	A, B, D
9105	75	83	16.3 (53.5)	UL CMP UL CL2P UL CATVP CSA CMP FT6 MIL-DTL-17/RG-11/U Type	B, D
M4208	75	84	16.1 (52.8)	MIL-DTL-17/RG-11A/U Type	A, B, D



Manhattan™ Coaxial Cable

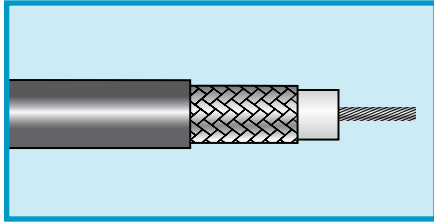

75-Ohm Video Cables

RG-179B/U and RG-187A/U Coaxial Cables

Part No.	Center Conductor		Dielectric			Shield Material, Coverage	Jacket	
	AWG (mm ²)	Stranding (mm)	Material	Material	Dia., In. (mm)		Material	Dia., In. (mm)
9179B	30 (0.05)	7/38 (7 x 0.10)	SCW	PTFE	0.063 (1.60)	SPC Braid, 93%	Natural Tan FEP	0.100 (2.54)
9187A	30 (0.05)	7/38 (7 x 0.10)	SCW	PTFE	0.063 (1.60)	SPC Braid, 93%	Natural PTFE Tape	0.105 (2.67)

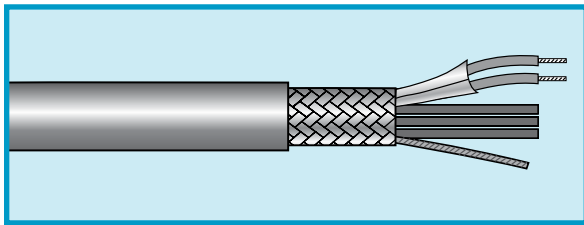

Ethernet Transceiver Cables

Part No.	Pairs			Dielectric			Shield Material, Coverage
	Type	AWG (mm ²)	Stranding (mm)	Material	Material	Dia., In. (mm)	
9852C	Data (3)	22 (0.35)	7/30 (7 x 0.25)	TC	Foam HDPE	0.064 (1.63)	A/P (pairs) A/P/A (overall) TC Braid, 95%
	Power (1)	20 (0.56)	7/28 (7 x 0.32)	TC	SR-PVC	0.058 (1.47)	
9853C	Data (3)	20 (0.56)	7/28 (7 x 0.32)	TC	Foam HDPE	0.077 (1.96)	A/P (pairs) A/P (overall) TC Braid, 95%
	Power (1)	20 (0.56)	7/28 (7 x 0.32)	TC	SR-PVC	0.058 (1.47)	
9854C	Data (3)	28 (0.08)	7/36 (7 x 0.12)	TC	PP	0.033 (0.84)	A/P (pairs) A/P/A (overall) TC Braid, 90%
	Power (1)	24 (0.23)	7/32 (7 x 0.20)	TC	SR-PVC	0.044 (1.12)	

Key to Abbreviations

A/P	Aluminum/polyester
A/P/A	Aluminum/polyester/aluminum
BC	Bare copper
BCW	Bare copper-coated steel
FEP	Fluorinated ethylene propylene
HDPE	High-density polyethylene
PE	Polyethylene
PP	Polypropylene
PTFE	Polytetrafluoroethylene
PVC	Polyvinyl chloride
PVDF	Polyvinylidene fluoride
SCW	Silver-coated, copper-coated steel
SPC	Silver-plated copper
SR-PVC	Semirigid PVC
TC	Tinned copper

Color Coding

Conductor	Color Code	
	9852C, 9853C	9854C
Data 1	Green-Blue	White-Gray
Data 2	Yellow-Orange	Yellow-Orange
Data 3	White-Brown	Green-Blue
Power	Blue-Red	Black-Red



Manhattan™ Coaxial Cable

75-Ohm Video Cables					
RG-179B/U and RG-187A/U Coaxial Cables					
Part No.	Nom. Impedance (Ω)	Vp (%)	Capacitance, pF/ft (pF/m)	Specifications	Availability
9179B	75	70	19.5 (64)	MIL-DTL-17/RG-179B/U	A, B, D, G
9187A	75	70	19.5 (64)	MIL-DTL-17/RG-187A/U	A, B, D, G

Ethernet Transceiver Cables							
Part No.	Jacket		Electrical Characteristics—Data Pairs			Specifications	Availability
	Material	Dia., In. (mm)	Nom. Impedance (Ω)	Vp (%)	Capacitance, pF/ft (pF/m)		
9852C	Slate PVC	0.375 (9.53)	78	78	16.7 (54.8)	UL AWM 2919 UL CM CSA CMG FT4	D
9853C	Slate PVC	0.401(10.19)	78	78	16.7 (54.8)	UL CM CSA CMG FT4	D
9854C	Slate PVC	0.250 (6.35)	78	66	19.7 (64.6)	UL AWM 2919 UL CM CSA CMG FT4	D



Manhattan™ High-Temperature Wire and Cable

600 V, Multiconductor, PTFE, PTFE, Braid Shield

High Temperature

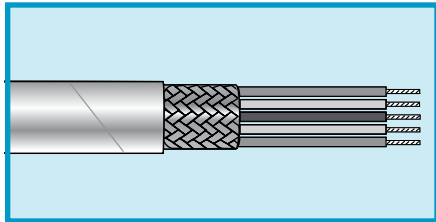

NEMA WC27500 Type RC
SAE AS22759/11

Operating Temperature

- -55°C to +200°C

Conductor Color Coding

- Per SAE AS22759/11

Materials

- Stranded silver-plated conductors
- PTFE insulation
- Silver-plated braid shield, 85% coverage
- Natural PTFE jacket

Availability

100 ft (30.5 m)
Bulk, cut to length
Spools may contain multiple lengths
(Minimums may apply)

24 AWG (0.24 mm²)

Stranding: 19/36 (19 x 0.13 mm)
Insulation thickness: 0.009 (0.24 mm)

Part No.	Conductors	Nominal Diameter		Jacket Thickness	
		Inch	mm	Inch	mm
24RC2S06	2	0.124	3.15	0.010	0.25
24RC3S06	3	0.130	3.30	0.010	0.25
24RC4S06	4	0.142	3.61	0.010	0.25

22 AWG (0.38 mm²)

Stranding: 19/34 (19 x 0.16 mm)
Insulation thickness: 0.009 (0.24 mm)

Part No.	Conductors	Nominal Diameter		Jacket Thickness	
		Inch	mm	Inch	mm
22RC2S06	2	0.136	3.45	0.010	0.25
22RC3S06	3	0.143	3.63	0.010	0.25
22RC4S06	4	0.156	3.96	0.010	0.25

20 AWG (0.61 mm²)

Stranding: 19/32 (19 x 0.20 mm)
Insulation thickness: 0.010 (0.25 mm)

Part No.	Conductors	Nominal Diameter		Jacket Thickness	
		Inch	mm	Inch	mm
20RC2S06	2	0.154	3.91	0.010	0.25
20RC3S06	3	0.163	4.14	0.010	0.25
20RC4S06	4	0.184	4.67	0.010	0.25

18 AWG (0.96 mm²)

Stranding: 19/30 (19 x 0.25 mm)
Insulation thickness: 0.011 (0.28 mm)

Part No.	Conductors	Nominal Diameter		Jacket Thickness	
		Inch	mm	Inch	mm
18RC2S06	2	0.180	4.57	0.010	0.25

Manhattan™ High-Temperature Wire and Cable

600 V, Multiconductor, ETFE, ETFE, Braid Shield
High Temperature

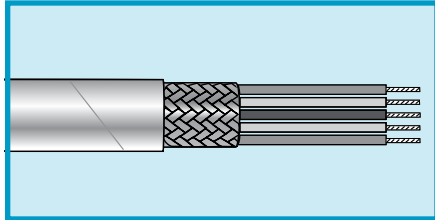

NEMA WC27500 Type TE SAE AS22759/16

Operating Temperature

- 55°C to +150°C

Conductor Color Coding

- Per SAE AS22759/16

Materials

- Stranded tinned copper conductors
- ETFE insulation
- Tinned copper braid shield, 85% coverage
- Natural ETFE jacket

Availability

100 ft (30.5 m)

Bulk, cut to length

Spools may contain multiple lengths

(Minimums may apply)

24 AWG (0.24 mm²)

Stranding: 19/36 (19 x 0.13 mm)
Insulation thickness: 0.011 (0.28 mm)

Part No.	Conductors	Nominal Diameter		Jacket Thickness	
		Inch	mm	Inch	mm
275002402	2	0.132	3.35	0.010	0.25

22 AWG (0.38 mm²)

Stranding: 19/34 (19 x 0.16 mm)
Insulation thickness: 0.011 (0.28 mm)

Part No.	Conductors	Nominal Diameter		Jacket Thickness	
		Inch	mm	Inch	mm
275002201	1	0.088	2.24	0.010	0.25
275002202	2	0.146	3.71	0.010	0.25
275002203	3	0.154	3.91	0.010	0.25
275002204	4	0.168	4.27	0.010	0.25

20 AWG (0.61 mm²)

Stranding: 19/32 (19 x 0.20 mm)
Insulation thickness: 0.011 (0.28 mm)

Part No.	Conductors	Nominal Diameter		Jacket Thickness	
		Inch	mm	Inch	mm
275002001	1	0.096	2.44	0.010	0.25
275002002	2	0.162	4.11	0.010	0.25
275002003	3	0.171	4.34	0.010	0.25
275002004	4	0.187	4.75	0.010	0.25

18 AWG (0.96 mm²)

Stranding: 19/30 (19 x 0.25 mm)
Insulation thickness: 0.012 (0.30 mm)

Part No.	Conductors	Nominal Diameter		Jacket Thickness	
		Inch	mm	Inch	mm
275001801	1	0.107	2.72	0.010	0.25
275001802	2	0.182	4.62	0.010	0.25

Manhattan™ High-Temperature Wire and Cable

600 V, Multiconductor, PTFE, PTFE, Braid Shield

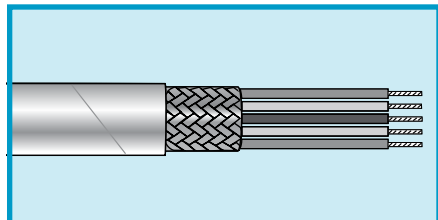

MIL-W-16878/4 (Type E)
NEMA HP3

Operating Temperature

- -55°C to +200°C

Conductor Color Coding

- Chart P (page 535)

Materials

- Silver-plated copper conductors
- PTFE insulation
- Silver-plated copper braid shield, 85% coverage
- White PTFE jacket

Availability

100 ft (30.5 m)
500 ft (152 m)
1000 ft (305 m)
Bulk, cut to length
Spools may contain multiple lengths
(Minimums may apply)

NEMA HP3-EXBEE

26 AWG (0.14 mm²)

Stranding: 7/34 (7 x 0.16 mm)
Insulation thickness: 0.010 (0.25 mm)

Part No.	Conductors	Nominal Diameter		Jacket Thickness	
		Inch	mm	Inch	mm
M1201	1	0.081	2.06	0.010	0.25
M1202	2	0.124	3.15	0.012	0.30
M1203	3	0.130	3.30	0.012	0.30
M1204	4	0.140	3.56	0.012	0.30

NEMA HP3-EXBEE

24 AWG (0.24 mm²)

Stranding: 19/36 (19 x 0.13 mm)
Insulation thickness: 0.010 (0.25 mm)

Part No.	Conductors	Nominal Diameter		Jacket Thickness	
		Inch	mm	Inch	mm
M1211	1	0.087	2.21	0.010	0.25
M1212	2	0.136	3.45	0.012	0.30
M1213	3	0.143	3.63	0.012	0.30
M1214	4	0.155	3.94	0.012	0.30

NEMA HP3-EXBFE

22 AWG (0.38 mm²)

Stranding: 19/34 (19 x 0.16 mm)
Insulation thickness: 0.009 (0.23 mm)

Part No.	Conductors	Nominal Diameter		Jacket Thickness	
		Inch	mm	Inch	mm
M1221	1	0.092	2.34	0.010	0.25
M1222	2	0.146	3.71	0.012	0.30
M1223	3	0.154	3.91	0.012	0.30
M1224	4	0.167	4.24	0.012	0.30

NEMA HP3-EXBGE

20 AWG (0.61 mm²)

Stranding: 19/32 (19 x 0.20 mm)
Insulation thickness: 0.009 (0.23 mm)

Part No.	Conductors	Nominal Diameter		Jacket Thickness	
		Inch	mm	Inch	mm
M1231	1	0.100	2.54	0.010	0.25
M1232	2	0.158	4.01	0.012	0.30
M1233*	3	0.171	4.34	0.010	0.25
M1234	4	0.186	4.72	0.012	0.30

*NEMA HP3-EXBJE.

Manhattan™ High-Temperature Wire and Cable

600 V, Multiconductor, PTFE, PTFE, Braid Shield

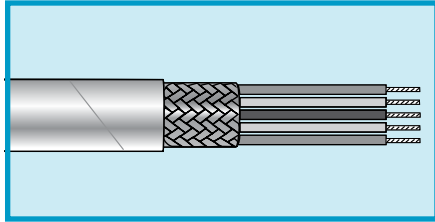

MIL-W-16878/14 (Type E)
NEMA HP3

Operating Temperature

- -55°C to +200°C

Conductor Color Coding

- Chart P (page 535)

Materials

- Silver-plated copper conductors
- PTFE insulation
- Silver-plated copper braid shield, 85% coverage
- White PTFE jacket

Availability

100 ft (30.5 m)
500 ft (152 m)
1000 ft (305 m)
Bulk, cut to length
(Minimums may apply)

NEMA HP3-EXBHE

18 AWG (0.96 mm²)

Stranding: 19/30 (19 x 0.25 mm)
Insulation thickness: 0.010 (0.25 mm)

Part No.	Conductors	Nominal Diameter		Jacket Thickness	
		Inch	mm	Inch	mm
M1241*	1	0.112	2.84	0.010	0.25
M1242	2	0.186	4.72	0.012	0.30
M1243	3	0.197	5.00	0.012	0.30
M1244	4	0.215	5.46	0.012	0.30

*NEMA HP3-EXBGE.

NEMA HP3-EXBJE

16 AWG (1.23 mm²)

Stranding: 19/29 (19 x 0.29 mm)
Insulation thickness: 0.012 (0.30 mm)

Part No.	Conductors	Nominal Diameter		Jacket Thickness	
		Inch	mm	Inch	mm
M1251	1	0.122	3.10	0.010	0.25
M1252	2	0.206	5.23	0.012	0.30
M1253	3	0.219	5.56	0.012	0.30
M1254	4	0.240	6.10	0.012	0.30

Manhattan™ High-Temperature Wire and Cable

600 V, Multiconductor, PTFE, FEP, Braid Shield

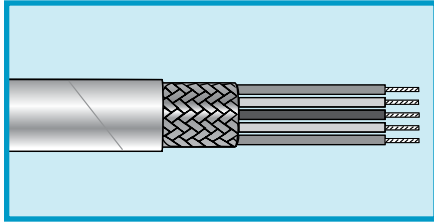

MIL-W-16878/4 (Type E) Components

Operating Temperature

- 55°C to +200°C

Conductor Color Coding

- Chart P (page 535)

Materials

- Silver-plated copper conductors
- PTFE insulation
- Silver-plated copper braid shield, 85% coverage
- White FEP jacket

Availability

100 ft (30.5 m)

500 ft (152 m)

Bulk, cut to length

Spools may contain multiple lengths

(Minimums may apply)

24 AWG (0.24 mm²)

Stranding: 19/36 (19 x 0.13 mm)
Insulation thickness: 0.0095 (0.24 mm)

Part No.	Conductors	Nominal Diameter		Jacket Thickness	
		Inch	mm	Inch	mm
72402	2	0.136	3.45	0.012	0.30

22 AWG (0.38 mm²)

Stranding: 19/34 (19 x 0.16 mm)
Insulation thickness: 0.0095 (0.24 mm)

Part No.	Conductors	Nominal Diameter		Jacket Thickness	
		Inch	mm	Inch	mm
72203	3	0.154	3.91	0.012	0.30

20 AWG (0.61 mm²)

Stranding: 19/32 (19 x 0.20 mm)
Insulation thickness: 0.0095 (0.24 mm)

Part No.	Conductors	Nominal Diameter		Jacket Thickness	
		Inch	mm	Inch	mm
72001	1	0.100	2.54	0.010	0.25

18 AWG (0.96 mm²)

Stranding: 19/30 (19 x 0.25 mm)
Insulation thickness: 0.010 (0.25 mm)

Part No.	Conductors	Nominal Diameter		Jacket Thickness	
		Inch	mm	Inch	mm
71801	1	0.112	2.84	0.010	0.25
71802	2	0.186	4.72	0.012	0.30

16 AWG (1.23 mm²)

Stranding: 19/29 (19 x 0.29 mm)
Insulation thickness: 0.012 (0.030 mm)

Part No.	Conductors	Nominal Diameter		Jacket Thickness	
		Inch	mm	Inch	mm
71602	2	0.206	5.23	0.012	0.30

Manhattan™ Cordsets

125 and 250 V M.A.P. Multiple Application Power Cords
Twin-End Jumper and Power Cords

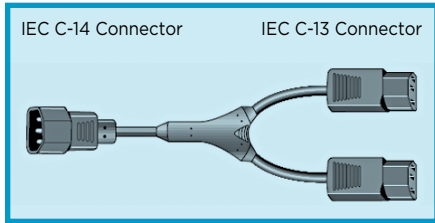
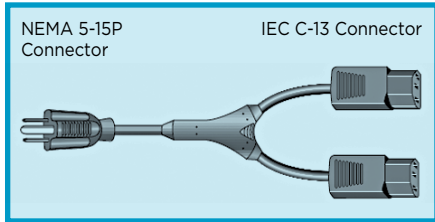

SJT
UL Standard 817
CSA C22.2 No. 21

Operating Temperature

- -20°C to +60°C

Conductor Color Coding

- Black, white, green (NEC)

Materials

- Stranded bare copper conductors
- PVC insulation
- Black PVC jacket

Availability

25-piece packages
(Minimums may apply)

6-ft (1.8 m) Overall Length; Individual Leg Length Is 2 ft (0.6 m)

Part No.		Wire Size		Stranding		Nominal Diameter		Power Rating		
Jumper	Power	AWG	mm ²	AWG	mm	Inch	mm	Watts	Amps	Volts
468	472	18	0.82	41/34	41 x 0.16	0.300	7.62	1250	10	125
470	474	16	1.32	65/34	65 x 0.16	0.325	8.26	3250	13	250



Manhattan™ Cordsets

125 V Power Cords 3-Conductor

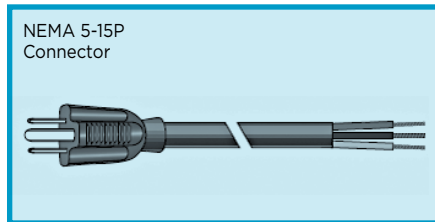

SJ, SJT, SVT
UL 62 and 817
CSA C22.2 No. 21 and 49
Operating Temperature

- -20°C to +60°C

Conductor Color Coding

- Black, white, green or green/yellow (NEC)
- Blue, brown, green/yellow (ICC)

Materials

- Stranded bare copper conductors
- PVC or rubber insulation
- Aluminum/polyester foil shield (where specified)
Foil facing inward
- 22 AWG (0.35 mm²) tinned copper drain wire
- Black PVC, rubber, or neoprene jacket (slate where marked)

Availability

25-piece packages
B suffix = 100-piece packages
(Minimums may apply)

PVC Jacket, PVC Insulation, Unshielded, SJT
Leads: Jacket Stripped 1.5" (38 mm). Leads Stripped 5/8" (16 mm)

Part No.		Cord Length		Wire Size		Stranding		Nominal Diameter		Power Rating		Color Code
25 pc	100 pc	Ft	m	AWG	mm ²	AWG	mm	Inch	mm	Watts	Amps	
501	501B	6' 7"	2	18	0.82	41/34	41 x 0.16	0.330	8.38	1250	10	ICC
502	502B	9' 10"	3	18	0.82	41/34	41 x 0.16	0.330	8.38	1250	10	ICC
780*	780B*	6' 0"	1.8	18	0.81	16/30	16 x 0.25	0.330 (0.300)**	8.38 (7.62)**	1250	10	NEC
779*	779B*	8' 0"	2.4	18	0.81	16/30	16 x 0.25	0.300 (0.330)†	7.62 (8.38)†	1250	10	NEC
503	—	6' 7"	2	16	1.32	65/34	65 x 0.16	0.331	8.41	1625	13	ICC
505	505B	6' 7"	2	14	2.08	41/30	41 x 0.25	0.380	9.65	1875	15	ICC
506	—	9' 10"	3	14	2.08	41/30	41 x 0.25	0.380	9.65	1875	15	ICC

*Slate jacket

**Diameter for part no. 780B

†Diameter for part no. 779B

PVC Jacket, PVC Insulation, Shielded, SVT
Leads: Jacket Stripped 1.5" (38 mm). Leads Stripped 5/8" (16 mm)

Part No.		Cord Length		Wire Size		Stranding		Nominal Diameter		Power Rating		Color Code
25 pc	100 pc	Ft	m	AWG	mm ²	AWG	mm	Inch	mm	Watts	Amps	
777*	777B*	6' 0"	1.8	18	0.82	41/34	41 x 0.16	0.250	6.35	1250	10	NEC
787*	787B*	8' 0"	2.4	18	0.82	41/34	41 x 0.16	0.250	6.35	1250	10	NEC
507F	—	6' 7"	2	18	0.82	41/34	41 x 0.16	0.260	6.60	1250	10	ICC
508F	—	9' 10"	3	18	0.82	41/34	41 x 0.16	0.260	6.60	1250	10	ICC

*Slate jacket



Manhattan™ Cordsets

125 V Power Cords 3-Conductor

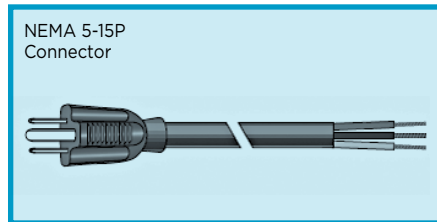

**SJ, SJT, SVT
UL 62 and 817
CSA C22.2 No. 21 and 49**

Operating Temperature

- -20°C to +60°C

Conductor Color Coding

- Black, white, green or green/yellow (NEC)
- Blue, brown, green/yellow (ICC)

Materials

- Stranded bare copper conductors
- PVC or rubber insulation
- Aluminum/polyester foil shield (where specified)
Foil facing inward
22 AWG (0.35 mm²) tinned copper drain wire
- Black PVC, rubber, or neoprene jacket (slate where marked)

Availability

25-piece packages
(Minimums may apply)

Rubber Jacket, Rubber Insulation, Unshielded, SJ
Leads: Jacket Stripped 1.5" (38 mm). Leads Stripped 5/8" (16 mm)

Part No.	Cord Length		Wire Size		Stranding		Nominal Diameter		Power Rating		Color Code
	Ft	m	AWG	mm ²	AWG	mm	Inch	mm	Watts	Amps	
615	6' 0"	1.8	18	0.81	16/30	16 x 0.25	0.320	7.13	1250	10	NEC
616	9' 0"	2.7	18	0.81	16/30	16 x 0.25	0.320	8.13	1250	10	NEC
778	8' 0"	2.4	18	0.81	16/30	16 x 0.25	0.320	8.13	1250	10	NEC
782	12' 0"	3.7	18	0.81	16/30	16 x 0.25	0.320	8.13	1250	10	NEC
783	9' 0"	2.7	16	1.31	26/30	26 x 0.25	0.340	8.64	1625	13	NEC
784	12' 0"	3.7	16	1.31	26/30	26 x 0.25	0.340	8.64	1625	13	NEC
788	9' 0"	2.7	14	2.08	41/30	41 x 0.25	0.380	9.65	1875	15	NEC
789	15' 0"	4.5	14	2.08	41/30	41 x 0.25	0.380	9.65	1875	15	NEC

Neoprene Jacket, Rubber Insulation, Unshielded, SJO
Leads: Jacket Stripped 1.5" (38 mm). Leads Stripped 5/8" (16 mm)

Part No.	Cord Length		Wire Size		Stranding		Nominal Diameter		Power Rating		Color Code
	Ft	m	AWG	mm ²	AWG	mm	Inch	mm	Watts	Amps	
781	8' 0"	2.4	18	0.81	16/30	16 x 0.25	0.330	8.38	1250	10	NEC

Rubber Jacket, Rubber Insulation, Unshielded, SV
Leads: Jacket Stripped 1.5" (38 mm). Leads Stripped 5/8" (16 mm)

Part No.	Cord Length		Wire Size		Stranding		Nominal Diameter		Power Rating		Color Code
	Ft	m	AWG	mm ²	AWG	mm	Inch	mm	Watts	Amps	
775	6' 0"	1.8	18	0.82	41/34	41 x 0.16	0.260	6.60	1250	10	NEC
776	8' 0"	2.4	18	0.82	41/34	41 x 0.16	0.260	6.60	1250	10	NEC



Manhattan™ Cordsets

125 V Electronic Line Cords 3-Conductor

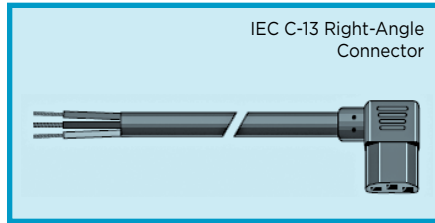
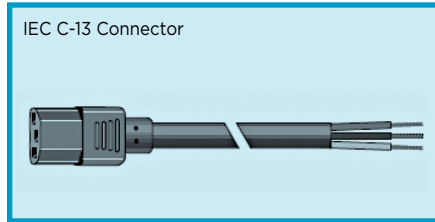

SJT, SVT
UL 62 and 817
CSA C22.2 No. 21 and 49

Operating Temperature

- -20°C to +60°C

Conductor Color Coding

- Blue, brown, green/yellow (ICC)

Materials

- Stranded bare copper conductors
- PVC insulation

- Aluminum/polyester foil shield (where specified)
Foil facing inward
20 AWG (0.56 mm²) tinned copper drain wire
- PVC jacket, black (slate where marked)

Availability

25-piece packages
(Minimums may apply)

PVC, Unshielded, Type SJT
Leads: Jacket Stripped 1.5" (38 mm). Leads Stripped 5/8" (16 mm)

Part No.	Cord Length		Wire Size		Stranding		Nominal Diameter		Power Rating	
	Ft	m	AWG	mm ²	AWG	mm	Inch	mm	Watts	Amps
511	6' 7"	2	18	0.82	41/34	41 x 0.16	0.300	7.62	1250	10
512	9' 10"	3	18	0.82	41/34	41 x 0.16	0.300	7.72	1250	10
513	6' 7"	2	16	1.32	65/34	65 x 0.16	0.331	8.41	1625	13
514	9' 10"	3	16	1.32	65/34	65 x 0.16	0.331	8.41	1625	13

PVC, Shielded, Right Angle, Type SJT
Leads: Jacket Stripped 1.5" (38 mm). Leads Stripped 5/8" (16 mm)

Part No.	Cord Length		Wire Size		Stranding		Nominal Diameter		Power Rating	
	Ft	m	AWG	mm ²	AWG	mm	Inch	mm	Watts	Amps
521F	6' 7"	2	14	2.08	41/30	41 x 0.25	0.380	9.65	1825	15

PVC, Shielded, Type SVT
Leads: Jacket Stripped 1.5" (38 mm). Leads Stripped 5/8" (16 mm)

Part No.	Cord Length		Wire Size		Stranding		Nominal Diameter		Power Rating	
	Ft	m	AWG	mm ²	AWG	mm	Inch	mm	Watts	Amps
523	7' 5"	2.3	18	0.82	41/34	41 x 0.16	0.250	6.35	1250	10



Manhattan™ Cordsets

125 V Jumper Cords

NEMA and IEC Connectors

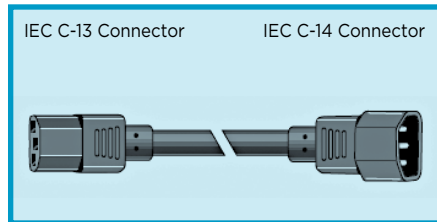

Jumper Cords

**SJ, SJT, SVT, SPT-1
UL 62 and 817
CSA C22.2 No. 21 and 49**

Operating Temperature

- -20°C to +60°C

Conductor Color Coding

- Blue, brown, green/yellow (ICC)
- Black, white, green (NEC)

Materials

- Stranded bare copper conductors
- PVC or rubber insulation

- Aluminum/polyester foil shield (where specified)
Foil facing inward
22 AWG (0.35 mm²) tinned copper drain wire
- Black PVC or rubber jacket (Part 601B available in white or slate jacket)

Availability

25-piece packages
(Minimums may apply)

PVC, Unshielded, Type SJT

Part No.	Cord Length		Wire Size		Stranding		Nominal Diameter		Power Rating		Color Code
	Ft	m	AWG	mm ²	AWG	mm	Inch	mm	Watts	Amps	
551	3' 3"	1	18	0.82	41/34	41 x 0.16	0.300	7.62	1250	10	ICC

PVC, Shielded, Type SVT

Part No.	Cord Length		Wire Size		Stranding		Nominal Diameter		Power Rating		Color Code
	Ft	m	AWG	mm ²	AWG	mm	Inch	mm	Watts	Amps	
560F	3' 3"	1	18	0.82	41/34	41 x 0.16	0.260	6.60	1250	10	ICC



Manhattan™ Cordsets

125 V Jumper Cords NEMA and IEC Connectors

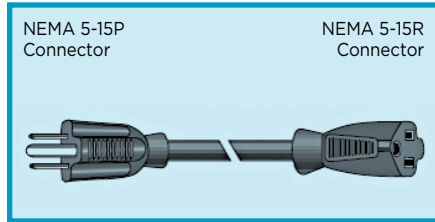

Extension Cords

Rubber, Unshielded, Type SJ

Part No.	Cord Length		Wire Size		Stranding		Nominal Diameter		Power Rating		Color Code
	Ft	m	AWG	mm ²	AWG	mm	Inch	mm	Watts	Amps	
633	10' 0"	3.1	16	1.32	26/30	26 x 0.25	0.340	8.64	1625	13	NEC
640	15' 0"	4.6	16	1.32	26/30	26 x 0.25	0.340	8.64	1625	13	NEC

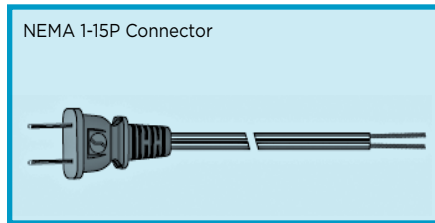

Parallel Lamp Cords

PVC, Unshielded, Type SPT-1

Leads: Conductors Split 1" (25.4 mm) and Stripped 5/8" (16 mm)

Part No.	Cord Length		Wire Size		Stranding		Nominal Dimension		Power Rating	
	Ft	m	AWG	mm ²	AWG	mm	Inch	mm	Watts	Amps
601B*	6' 0"	1.8	18	0.82	41/34	41 x 0.16	0.110 x 0.220	2.79 x 5.69	1250	10

*100-piece packages.



Manhattan™ Cordsets

125 V Detachable Power Supply Cords 3-Conductor

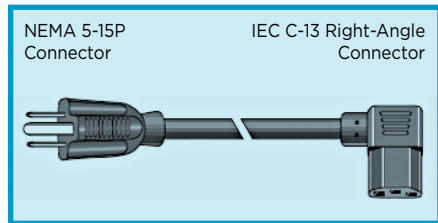
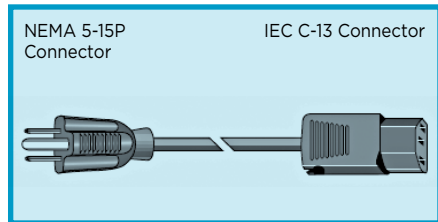

SJT, SVT
UL 62 and 817
CSA C22.2 No. 21 and 49

Operating Temperature

- -20°C to +60°C

Conductor Color Coding

- Blue, brown, green/yellow (ICC)
- Black, white, green or green/yellow (NEC)

Materials

- Stranded bare copper conductors
- PVC insulation
- Aluminum/polyester foil shield
Foil facing inward
Tinned copper drain wire
(see tables for size)
- Black PVC jacket

Availability

25-piece packages
B suffix = 100-piece packages
(Minimums may apply)

Unshielded, Straight, Types SVT and SJT

Part No.		Cord Length		Wire Size		Stranding		Nominal Diameter		Power Rating		Color Code
25 pc	100 pc	Ft	m	AWG	mm ²	AWG	mm	Inch	mm	Watts	Amps	
Type SVT												
545	545B	7' 5"	2.3	18	0.82	41/34	41 x 0.16	0.250	6.35	1250	10	NEC
535	535B	7' 5"	2.3	18	0.82	41/34	41 x 0.16	0.250	6.35	1250	10	NEC
Type SJT												
531	531B	6' 7"	2	18	0.82	41/34	41 x 0.16	0.330	8.38	1250	10	NEC
532	532B	9' 10"	3	18	0.82	41/34	41 x 0.16	0.330	8.38	1250	10	NEC
533	—	6' 7"	2	16	1.32	65/34	65 x 0.16	0.350	8.89	1625	13	ICC
546	—	7' 5"	2.3	16	1.32	65/34	65 x 0.16	0.350	8.89	1625	13	ICC
534	534B	9' 10"	3	16	1.32	65/34	65 x 0.16	0.331	8.41	1625	13	NEC

Shielded, Straight, Types SVT and SJT

Part No.	Cord Length		Wire Size		Stranding		Drain Wire*	Nominal Diameter		Power Rating		Color Code
	Ft	m	AWG	mm ²	AWG	mm		Inch	mm	Watts	Amps	
Type SVT												
547F	6' 7"	2	18	0.82	41/34	41 x 0.16	A	0.260	6.60	1250	10	ICC
548F	9' 10"	3	18	0.82	41/34	41 x 0.16	A	0.260	6.60	1250	10	ICC
Type SJT												
531F	6' 7"	2	18	0.82	41/34	41 x 0.16	B	0.317	8.05	1250	10	ICC
532F	9' 10"	3	18	0.82	41/34	41 x 0.16	B	0.317	8.05	1250	10	ICC
536F	9' 10"	3	14	2.08	41/30	41 x 0.25	C	0.400	10.16	1875	15	ICC

*Drain Wire:

A = 22 AWG (mm²), 7/30 (7 x 0.25 mm) stranding.

B = 18 AWG (0.82 mm²), 41/34 (41 x 0.16 mm) stranding.

C = 14 AWG (2.08 mm²), 41/30 (41 x 0.25 mm) stranding.



Manhattan™ Cordsets

125 V Detachable Power Supply Cords 3-Conductor

Unshielded, Right Angle, Type SJT

Part No.		Cord Length		Wire Size		Stranding		Nominal Diameter		Power Rating		Color Code
25 pc	100 pc	Ft	m	AWG	mm ²	AWG	mm	Inch	mm	Watts	Amps	
537	537B	6' 7"	2	18	0.82	41/34	41 x 0.16	0.330	8.38	1250	10	ICC
538		9' 10"	3	18	0.82	41/34	41 x 0.16	0.330	8.38	1250	10	ICC
540	—	9' 10"	3	16	1.32	65/34	65 x 0.16	0.331	8.41	1625	13	ICC

Shielded, Right Angle, Type SVT

Part No.	Cord Length		Wire Size		Stranding		Drain Wire*	Nominal Diameter		Power Rating		Color Code
	Ft	m	AWG	mm ²	AWG	mm		Inch	mm	Watts	Amps	
550F	9' 10"	3	18	0.82	41/34	41 x 0.16	A	0.260	6.60	1250	10	ICC

*Drain Wire:

A = 22 AWG (mm²), 7/30 (7 x 0.25 mm) stranding.

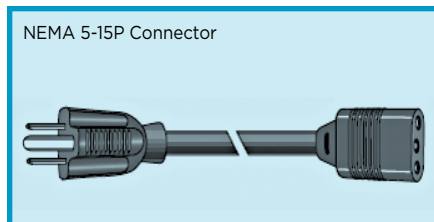

Unshielded, Straight, Type SVT

Part No.	Cord Length		Wire Size		Stranding		Nominal Diameter		Power Rating		Color Code
	Ft	m	AWG	mm ²	AWG	mm	Inch	mm	Watts	Amps	
543*	7' 5"	2.3	18	0.82	41/34	41 x 0.16	0.240	6.09	1250	7	ICC

*Also available with slate jacket.

Manhattan™ Cordsets

125 V Medical-Grade Power Supply Cordsets 3-Conductor

SJT

UL 62 and 817

CSA C22.2 No. 21 and 49

CSA FT2

Operating Temperature

- 20°C to +60°C

Conductor Color Coding

- Black, white, green

Materials

- Stranded bare copper conductors
- PVC insulation
- Black or slate PVC jacket

Availability

25-piece packages
(Minimums may apply)

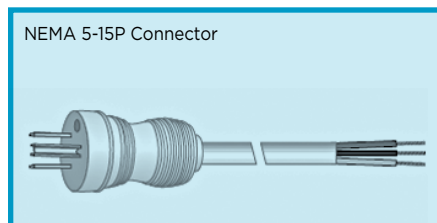

Leads: Jacket Stripped 2" (50 mm). Leads Stripped 5/8" (16 mm)

Part No.	Cord Length		Wire Size		Stranding		Nominal Diameter		Power Ratings		Colors	
	Ft	m	AWG	mm ²	AWG	mm	Inch	mm	Watts	Amps	Jacket	Plug
801	10' 0"	3.0	18	1.20	43/34	43 x 0.16	0.31	7.8	1250	10	Black	Clear
802	10' 0"	3.0	18	1.20	43/34	43 x 0.16	0.31	7.8	1250	10	Slate	Slate

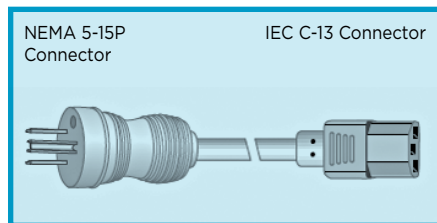

Part No.	Cord Length		Wire Size		Stranding		Nominal Diameter		Power Ratings		Colors		
	Ft	m	AWG	mm ²	AWG	mm	Inch	mm	Watts	Amps	Jacket	Plug	Recept.
820	10' 0"	3.0	18	1.20	43/34	43 x 0.16	0.31	7.8	1250	10	Black	Clear	Black
821	10' 0"	3.0	18	1.20	43/34	43 x 0.16	0.31	7.8	1250	10	Slate	Slate	Slate
822	10' 0"	3.0	18	1.20	43/34	43 x 0.16	0.31	7.8	1250	10	Slate	Clear	Clear
830	10' 0"	3.0	16	1.50	68/34	68 x 0.16	0.33	8.5	1625	13	Black	Clear	Black
831	10' 0"	3.0	16	1.50	68/34	68 x 0.16	0.33	8.5	1625	13	Slate	Slate	Slate
832	10' 0"	3.0	16	1.50	68/34	68 x 0.16	0.33	8.5	1625	13	Slate	Clear	Clear



Manhattan™ Cordsets

250 V Internationally Approved Power Supply Cordsets

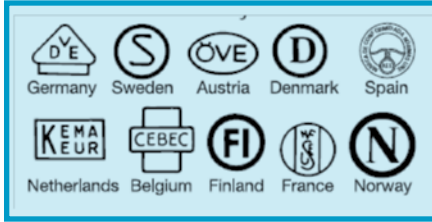

CE
ENEC-11
T-Mark
JET
UL
CSA
C-Tick

Operating Temperature

- 15°C to +70°C

Conductor Color Coding

- Blue, brown, yellow/green

Materials

- Stranded bare copper conductors
- PVC insulation
- Black PVC jacket

Availability

25-piece packages
 (Minimums may apply)

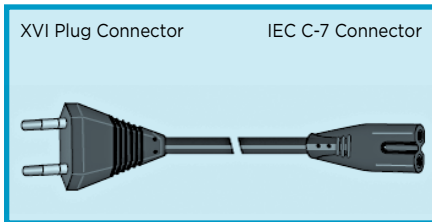

2-Conductor Unshielded. Cordage Type HO3VVH2F2XO.75

Part No.	Cord Length		Wire Size		Stranding		Nominal Diameter		Power Rating	
	Ft	m	AWG	mm ²	AWG	mm	Inch	mm	Watts	Amps
952	5' 6"	1.7	18	0.75	23/32	23 x 0.20	0.133 x 0.22	4.00 x 5.60	625	2.5

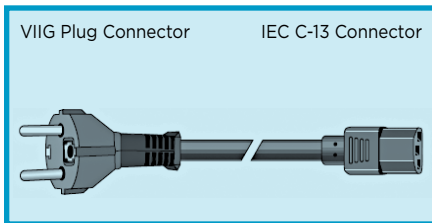

3-Conductor Unshielded. Cordage Type HO5VVF3G1.00

Part No.	Cord Length		Wire Size		Stranding		Nominal Diameter		Power Rating	
	Ft	m	AWG	mm ²	AWG	mm	Inch	mm	Watts	Amps
953	8' 2"	2.5	16	1.00	31/32	31 x 0.20	0.268	6.81	2500	2.5

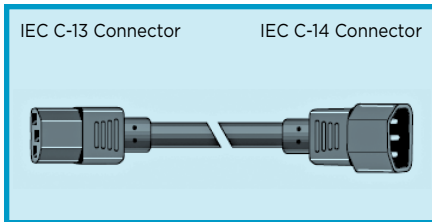

3-Conductor Unshielded. Cordage Type HARSJT3X18AWG

Part No.	Cord Length		Wire Size		Stranding		Nominal Diameter		Power Rating	
	Ft	m	AWG	mm ²	AWG	mm	Inch	mm	Watts	Amps
953	8' 2"	2.5	18	1.00	56/34	56 x 0.15	0.314	8.0	2500	10



Manhattan™ Cordsets

250 V Power Supply Cords, 3-Conductor Australia

SAA

Operating Temperature

- -15°C to +70°C

Conductor Color Coding

- Blue, brown, yellow/green

Materials

- Stranded bare copper conductors
- PVC insulation
- Black PVC jacket
- Cord Type: HO5VVF3G1.00

Availability

25-piece packages
(Minimums may apply)

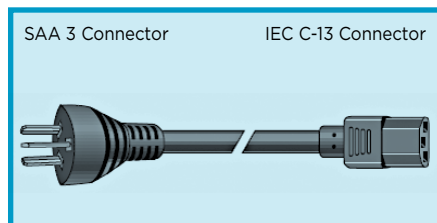

Part No.	Cord Length		Wire Size		Stranding		Nominal Diameter		Power Rating	
	Ft	m	AWG	mm ²	AWG	Mm	Inch	mm	Watts	Amps
910	8.2	2.5	16	1.00	31/32	31 x 0.20	0.270	6.80	2500	10

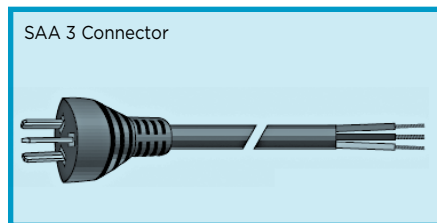

Leads: Jacket Stripped 30 mm (1.2"). Leads Stripped 6 mm (0.24")

Part No.	Cord Length		Wire Size		Stranding		Nominal Diameter		Power Rating	
	Ft	m	AWG	mm ²	AWG	Mm	Inch	mm	Watts	Amps
911	8.2	2.5	16	1.00	31/32	31 x 0.20	0.270	6.80	2500	10



Manhattan™ Cordsets

300 V and 600 V Conductor Cordage CPE

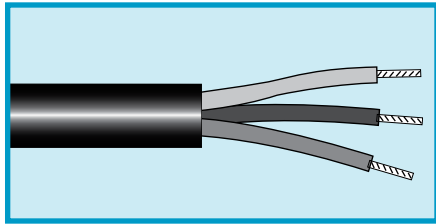

SVO, SJOW, SOOW
UL 62
CSA C22.2 No. 49
CSA FT2

Operating Temperature

- 40°C to +90°C

Conductor Color Coding

- Black, white (2 conductors)
- Black, white, green (3 conductors)
- Black, white, green, red (4 conductors)

Materials

- Stranded bare copper conductors
- Rubber insulation
- Black chlorinated polyethylene (CPE) jacket

Availability

250 ft (76.2 m)
(Minimums may apply)

CPE Jacket, 2-Conductor Cords, Types SVO, SJOW, and SOOW

Part No.	Wire Size		Stranding		Insulation Thickness		Jacket Thickness		Cable Dimension	
	AWG	mm ²	AWG	Mm	Inch	mm	Inch	mm	Inch	mm
Type SVO, 300 V										
1931	18	0.82	41/34	41 x 0.16	0.017	0.43	0.034	0.86	0.236	5.99
Type SJOW, 300 V										
1932	18	0.81	16/30	16 x 0.25	0.032	0.81	0.034	0.86	0.294	7.47
1933	16	1.32	26/30	26 x 0.25	0.032	0.81	0.034	0.86	0.320	8.13
Type SOOW, 600 V										
1934	18	0.81	16/30	16 x 0.25	0.031	0.79	0.065	1.65	0.356	9.04
1935	16	1.32	26/30	26 x 0.25	0.031	0.79	0.065	1.65	0.382	9.70
1936	14	2.08	41/30	41 x 0.25	0.048	1.22	0.085	2.16	0.516	13.11
1937	12	3.29	65/30	65 x 0.25	0.050	1.27	0.100	2.54	0.592	15.04

CPE Jacket, 3-Conductor Cords, Types SJOW and SOOW

Part No.	Wire Size		Stranding		Insulation Thickness		Jacket Thickness		Cable Dimension	
	AWG	mm ²	AWG	mm	Inch	mm	Inch	mm	Inch	mm
Type SJOW, 300 V										
1932/3	18	0.81	16/30	16 x 0.25	0.032	0.81	0.034	0.86	0.330	7.85
1933/3	16	1.32	26/30	26 x 0.25	0.032	0.81	0.034	0.86	0.358	8.64
Type SOOW, 600 V										
1934/3	18	0.81	16/30	16 x 0.25	0.031	0.79	0.065	1.65	0.373	9.47
1935/3	16	1.32	26/30	26 x 0.25	0.031	0.79	0.065	1.65	0.401	10.19
1936/3	14	1.08	41/30	41 x 0.25	0.048	1.22	0.085	2.16	0.543	13.79
1937/3	12	3.29	65/30	65 x 0.25	0.050	1.27	0.100	2.54	0.623	15.82
1938/3	10	5.32	105/30	105 x 0.25	0.050	1.27	0.100	2.54	0.642	16.31

CPE Jacket, 4-Conductor Cords, Type SOOW, 600 V

Part No.	Wire Size		Stranding		Insulation Thickness		Jacket Thickness		Cable Dimension	
	AWG	mm ²	AWG	mm	Inch	mm	Inch	mm	Inch	mm
1934/4	18	0.81	16/30	16 x 0.25	0.031	0.79	0.065	1.65	0.400	10.16
1935/4	16	1.32	26/30	26 x 0.25	0.031	0.79	0.065	1.65	0.437	11.10
1936/4	14	2.08	41/30	41 x 0.25	0.048	1.22	0.085	2.16	0.589	14.96
1937/4	12	3.29	65/30	65 x 0.25	0.050	1.27	0.100	2.54	0.674	17.12
1938/4	10	5.32	105/30	105 x 0.25	0.050	1.27	0.100	2.54	0.735	18.67



Manhattan™ Cordsets

300 V 3-Conductor Cordage PVC

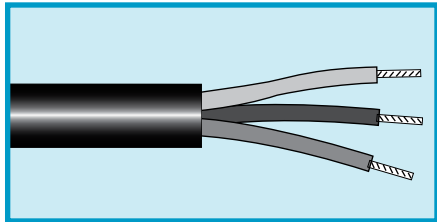

SJT, SVT
UL 62
CSA C22.2 No. 49

Operating Temperature

- -30°C to +105°C

Conductor Color Coding

- Black, white, green/yellow (NEC)
- Blue, brown, green/yellow (IEC 60446)

Materials

- Stranded bare copper conductors
- PVC insulation
- Aluminum/polyester foil shield
Foil facing inward
Tinned copper drain wire one even AWG size smaller than conductor
- Black or slate PVC jacket

Availability

250 ft (76.2 m)
(Minimums may apply)

3-Conductor Cords (Unshielded)

Part No.	Wire Size		Stranding		Insulation Thickness		Jacket Thickness		Cable Dimension		Color Code
	AWG	mm ²	AWG	mm	Inch	mm	Inch	mm	Inch	mm	
Type SJT											
1952/3T	18	0.82	41/34	41 x 0.16	0.032	0.81	0.032	0.81	0.309	7.85	NEC
1953/3T	16	1.32	65/34	65 x 0.16	0.032	0.81	0.032	0.81	0.335	8.51	NEC
Type SVT											
1951/3T	18	0.82	41/34	41 x 0.16	0.016	0.41	0.032	0.81	0.241	6.12	NEC
Type SJT											
1941/3*	18	0.82	41/34	41 x 0.16	0.032	0.81	0.032	0.81	0.310	7.87	IEC
1942/3*	16	1.32	65/34	65 x 0.16	0.032	0.81	0.032	0.81	0.336	8.53	IEC
1943/3*	14	2.08	41/30	41 x 0.25	0.032	0.81	0.032	0.81	0.368	9.35	IEC

*Black jacket only.

3-Conductor Cords (Foil Shield)

Part No.	Wire Size		Stranding		Insulation Thickness		Jacket Thickness		Cable Dimension		Color Code
	AWG	mm ²	AWG	mm	Inch	mm	Inch	mm	Inch	mm	
Type SJT											
1941/3F*	18	0.82	41/34	41 x 0.16	0.032	0.81	0.032	0.81	0.314	7.98	IEC
1942/3F*	16	1.32	65/34	65 x 0.16	0.032	0.81	0.032	0.81	0.340	8.64	IEC
1943/3F*	14	2.08	41/30	41 x 0.25	0.032	0.81	0.032	0.81	0.372	9.45	IEC

*Black jacket only.



Manhattan™ Cordsets

300 V 3-Conductor Cordage

Rubber

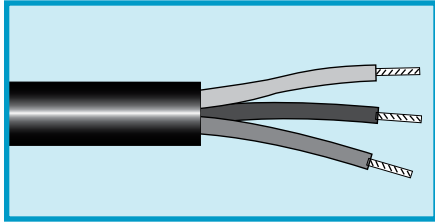

SJ, SV
UL 62
CSA C22.2 No. 49

Operating Temperature

- -30°C to +90°C

Conductor Color Coding

- Black, white, green

Materials

- Stranded bare copper conductors
- Rubber insulation
- Black chlorinated polyethylene jacket

Availability

250 ft (76.2 m)
 (Minimums may apply)

3-Conductor Cords (Unshielded)

Part No.	Wire Size		Stranding		Insulation Thickness		Jacket Thickness		Cable Dimension	
	AWG	mm ²	AWG	mm	Inch	mm	Inch	mm	Inch	mm
Type SJ										
1952/3	18	0.81	16/30	16 x 0.25	0.032	0.81	0.034	0.86	0.309	7.85
1953/3	16	1.32	26/30	26 x 0.25	0.032	0.81	0.034	0.86	0.340	8.64
Type SV										
1951/3	18	0.82	41/34	41 x 0.16	0.017	0.43	0.036	0.91	0.256	6.50



Manhattan™ Cordsets

300 V Retractable Communications Cords

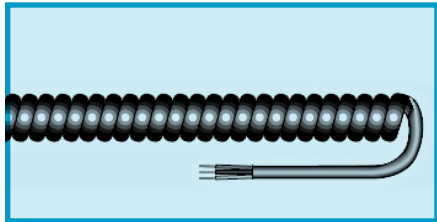

UL AWM 2464

Operating Temperature

- -20°C to +80°C

Conductor Color Coding

- See table

Materials

- Stranded tinned copper conductors
- Polypropylene insulation
- Black PVC Jacket

Availability

1-piece packages
(Minimums may apply)

Unshielded, 1 A
Cord Length: 1 ft (0.30 m) Retracted, 5 ft (1.5 m) Extended

23 AWG (0.27 mm²)

Stranding: 21/36 (21 x 0.13 mm)
Insulation thickness: 0.012 (0.30 mm)
Lead length, each end: 12" (304 mm)

Part No.	Conductors	Coil Diameter		Jacket Diameter	
		Inch	mm	Inch	mm
702R	2	0.688	17.48	0.190	4.83
703R	3	0.688	17.48	0.200	5.08
704R	4	0.750	19.05	0.220	5.59
705R	5	0.875	22.23	0.230	5.84
706R	6	0.875	22.23	0.230	5.84
707R	7	0.875	22.23	0.250	6.35

Unshielded, 1 A
Cord Length: 2 ft (0.61 m) Retracted, 10 ft (3.0 m) Extended

23 AWG (0.27 mm²)

Stranding: 21/36 (21 x 0.13 mm)
Insulation thickness: 0.012 (0.30 mm)
Lead length, each end: 6" (152 mm)

Part No.	Conductors	Coil Diameter		Jacket Diameter	
		Inch	mm	Inch	mm
702/2R	2	0.625	15.88	0.180	4.57
703/2R	3	0.688	17.48	0.190	4.83
704/2R	4	0.688	17.48	0.200	5.08
705/2R	5	0.750	19.05	0.215	5.46
706/2R	6	0.875	22.23	0.230	5.84
707/2R	7	0.875	22.23	0.230	5.84

Unshielded, 1 A
Cord Length: 3 ft (0.91 m) Retracted, 15 ft (4.5 m) Extended

23 AWG (0.27 mm²)

Stranding: 21/36 (21 x 0.13 mm)
Insulation thickness: 0.012 (0.30 mm)
Lead length, each end: 6" (152 mm)

Part No.	Conductors	Coil Diameter		Jacket Diameter	
		Inch	mm	Inch	mm
704/3R	4	0.688	17.48	0.200	5.08
705/3R	5	0.750	19.05	0.210	5.33
706/3R	6	0.875	22.23	0.230	5.84
707/3R	7	0.875	22.23	0.230	5.84



Manhattan™ Cordsets

300 V Retractable Communications Cords

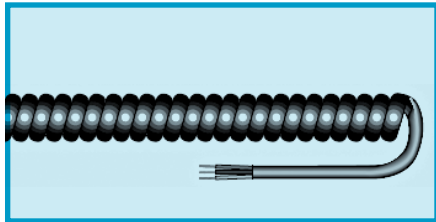

UL AWM 2464

Operating Temperature

- -20°C to +80°C

Conductor Color Coding

- See table

Materials

- Stranded tinned copper conductors
- Polypropylene insulation
- Black PVC Jacket

Availability

1-piece packages
(Minimums may apply)

Unshielded, 1 A
Cord Length: 4 ft (1.2 m) Retracted, 20 ft (6.1 m) Extended

23 AWG (0.27 mm²)

Stranding: 21/36 (21 x 0.13 mm)
Insulation thickness: 0.012 (0.30 mm)
Lead length, each end: 6" (152 mm)

Part No.	Conductors	Coil Diameter		Jacket Diameter	
		Inch	mm	Inch	mm
703/4R	3	0.688	17.48	0.190	4.83
704/4R	4	0.688	17.48	0.200	5.08
705/4R	5	0.750	19.05	0.220	5.59
706/4R	6	0.875	22.23	0.230	5.84
707/4R	7	0.875	22.23	0.230	5.84
708/4R	8	0.875	22.23	0.250	6.35
710/4R	10	0.938	23.83	0.280	7.11
712/4R	12	1.000	25.40	0.290	7.37
715/4R	15	1.063	27.00	0.310	7.87

Shielded: Spiral Wrapped Tinned Copper, 1A
Cord Length: 2 ft (0.61 m) Retracted, 10 ft (3.0 m) Extended

23 AWG (0.27 mm²)

Stranding: 21/36 (21 x 0.13 mm)
Insulation thickness: 0.012 (0.30 mm)
Lead length, each end: 6" (152 mm)

Part No.	Conductors	Coil Diameter		Cord Diameter		Shielding
		Inch	mm	Inch	mm	
722/2R	2	0.750	19.05	0.210	5.33	Individual conductors
723/2R	3	0.750	19.05	0.200	5.08	2 unshielded 1 shielded

Conductor Color Coding

1 Black	6 Blue	11 Violet
2 White	7 Yellow	12 Tan
3 Red	8 Brown	13 White/Black
4 Green	9 Slate	14 Red/Black
5 Orange	10 Pink	15 Green/Black



Manhattan™ Cordsets

300 V Retractable Communications Cords

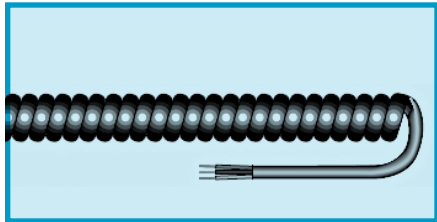

UL AWM 4182, 4194, 4195, 4196, 4197, 4198

Operating Temperature

- -20°C to +60°C

Conductor Color Coding

- See table

Materials

- Stranded tinned copper conductors
- Rubber insulation
- Black neoprene jacket

Availability

1-piece packages
(Minimums may apply)

Unshielded, 1 A
Cord Length: 2 ft (0.61 m) Retracted, 10 ft (3.0 m) Extended

23 AWG (0.27 mm²)

Stranding: 21/36 (21 x 0.13 mm)
Insulation thickness:
Lead length, each end: 6" (152 mm)

Part No.	Conductors	Coil Diameter		Cord Diameter		AWM
		Inch	mm	Inch	mm	
680/2	2	0.750	19.05	0.220	5.59	4194
681/2	3	0.813	20.65	0.220	5.59	4195
682/2	4	0.938	23.83	0.250	6.35	4196
683/2	5	1.063	27.00	0.290	7.37	4197
684/2	6	1.125	28.58	0.310	7.87	4198
685/2	7	1.250	31.75	0.320	8.13	4182

Unshielded, 1 A
Cord Length: 4 ft (1.2 m) Retracted, 20 ft (6.1 m) Extended

23 AWG (0.27 mm²)

Stranding: 21/36 (21 x 0.13 mm)
Insulation thickness:
Lead length, each end: 6" (152 mm)

Part No.	Conductors	Coil Diameter		Cord Diameter		AWM
		Inch	mm	Inch	mm	
680/4	2	0.743	18.87	0.215	5.46	4194
681/4	3	0.753	19.13	0.220	5.59	4195
682/4	4	0.875	22.23	0.250	6.35	4196
683/4	5	1.008	25.60	0.285	7.24	4197
684/4	6	1.110	28.19	0.305	7.75	4198
685/4	7	1.140	28.96	0.320	8.13	4182

Conductor Color Coding

1 Black	5 Blue
2 White	6 Yellow
3 Red	7 Brown
4 Green	



Manhattan™ Cordsets

300 V Retractable Communications Cords

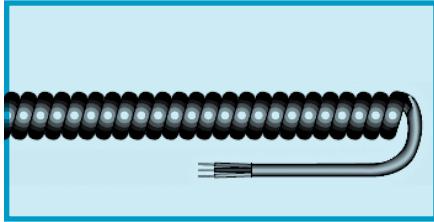

SO, SVO, SJO
UL 62
CSA C22.2 No. 49

Operating Temperature

- -20°C to +90°C

Conductor Color Coding

- 1 Black, 2 White, 3 Red, 4 Green

Materials

- Stranded bare copper conductors
- Rubber insulation
- Black rubber jacket

Availability

1-piece packages
 (Minimums may apply)

Types SV and SJO

Cord Length: 1 ft (0.30 m) Retracted, 5 ft (1.5 m) Extended

18 AWG (0.82 mm²)

Stranding: 41/34 (41 x 0.16 mm)
 Insulation thickness: 0.015 (0.38 mm)
 Lead length, each end: 6" (152 mm)

Part No.	Conductors	Coil Diameter		Cord Diameter	
		Inch	mm	Inch	mm
Type SVO					
725	2	0.895	22.73	0.220	5.59
Type SJO					
727	3	1.263	32.08	0.33	9.4

Type SVO

Cord Length: 2 ft (0.61 m) Retracted, 10 ft (3.0 m) Extended

18 AWG (0.82 mm²)

Stranding: 41/34 (41 x 0.16 mm)
 Insulation thickness: 0.015 (0.38 mm)
 Lead length, each end: 6" (152 mm)

Part No.	Conductors	Coil Diameter		Cord Diameter	
		Inch	mm	Inch	mm
760/2	3	1.000	25.40	0.27	7.0

Type SVO

Cord Length: 4 ft (1.2 m) Retracted, 20 ft (6.1 m) Extended

18 AWG (0.82 mm²)

Stranding: 41/34 (41 x 0.16 mm)
 Insulation thickness: 0.015 (0.38 mm)
 Lead length, each end: 6" (152 mm)

Part No.	Conductors	Coil Diameter		Cord Diameter	
		Inch	mm	Inch	mm
760/4	3	1.000	25.40	0.27	7.0



Manhattan™ Cordsets

300 V/600 V Retractable Communications Cords

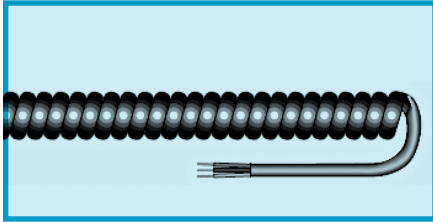

SO, SVO, SJO
UL 62
CSA C22.2 No. 49

Operating Temperature

- -20°C to +90°C

Conductor Color Coding

- 1 Black, 2 White, 3 Red, 4 Green

Materials

- Stranded bare copper conductors
- Rubber insulation
- Black rubber jacket

Availability

1-piece packages
 (Minimums may apply)

Type SJO, 300 V

Cord Length: 4 ft (1.2 m) Retracted, 20 ft (6.1 m) Extended

16 AWG (1.31 mm²)

Stranding: 65/34 (65 x 0.16 mm)
 Insulation thickness: 0.030 (0.76 mm)
 Lead length, each end: 6" (152 mm)

Part No.	Conductors	Coil Diameter		Cord Diameter	
		Inch	mm	Inch	mm
665/4	3	1.335	33.91	0.385	9.78

Type SO, 600 V

Cord Length: 2 ft (0.61 m) Retracted, 10 ft (3.0 m) Extended

14 AWG (2.08 mm²)

Stranding: 41/30 (41 x 0.25 mm)
 Insulation thickness: 0.030 (0.76 mm)
 Lead length, each end: 6" (152 mm)

Part No.	Conductors	Coil Diameter		Cord Diameter	
		Inch	mm	Inch	mm
674/2	4	2.055	52.20	0.610	15.49

Type SO, 600 V

Cord Length: 4 ft (1.2 m) Retracted, 20 ft (6.1 m) Extended

14 AWG (2.08 mm²)

Stranding: 41/30 (41 x 0.25 mm)
 Insulation thickness: 0.030 (0.76 mm)
 Lead length, each end: 6" (152 mm)

Part No.	Conductors	Coil Diameter		Cord Diameter	
		Inch	mm	Inch	mm
674/4	4	2.055	52.20	0.610	15.49



Manhattan™ Cordsets

300 V Retractable Power Cords

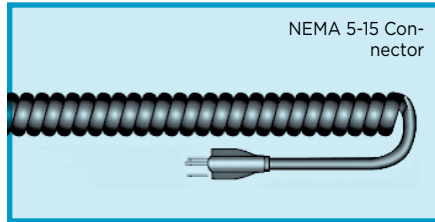

SVO, SJO
UL 62 and 817

Operating Temperature

- -20°C to +60°C

Conductor Color Coding

- 1 Black, 2 White, 3 Green or Green/Yellow

Materials

- Stranded bare copper conductors
- Rubber insulation
- Black neoprene jacket
- Molded NEMA 5-15P male plug, one end

Availability

1-piece packages
(Minimums may apply)

Types SVO and SJO

Cord Length: 1 ft (0.30 m) Retracted, 5 ft (1.5 m) Extended

18 AWG (0.82 mm²)

Stranding: 41/34 (41 x 0.16 mm)
Insulation thickness: 0.015 (0.38 mm)
Jacket stripped 1.5" (38.1 mm); insulation stripped 0.5" (12.7 mm)

Part No.	Conductors	Coil Diameter		Cord Diameter		Power Rating	
		Inch	mm	Inch	mm	Watts	Amps
Type SVO							
654	2	0.875	22.23	0.240	6.10	1250	10
Type SJO							
656	3	1.375	34.93	0.330	8.38	1250	10

Type SJO

Cord Length: 2 ft (0.61 m) Retracted, 10 ft (3.0 m) Extended

16 AWG (1.31 mm²)

Stranding: 65/34 (65 x 0.16 mm)
Insulation thickness: 0.015 (0.38 mm)
Jacket stripped 1.5" (38.1 mm); insulation stripped 0.5" (12.7 mm)

Part No.	Conductors	Coil Diameter		Cord Diameter		Power Rating	
		Inch	mm	Inch	mm	Watts	Amps
659	3	1.333	33.86	0.350	8.89	1625	13



Manhattan™ Cordsets

30 V Miniature Retractable Communications Cords

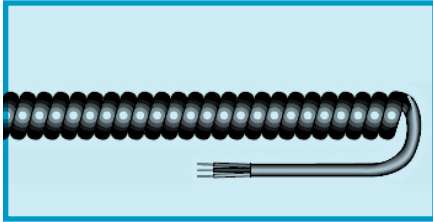

UL AWM 20013

Operating Temperature

- -20°C to +60°C

Conductor Color Coding

- 1 Black, 2 White, 3 Red, 4 Green

Materials

- Stranded tinned copper conductors
- PVC insulation
- Black PVC Jacket

Availability

1-piece packages

Cord length: 2 ft (0.61 m) retracted, 10 ft (3.0 m) extended

28 AWG (0.09 mm²)

Stranding: 19/40 (19 x 0.08 mm)
 Insulation thickness: 0.012 (0.30 mm)
 Lead length, each end: 6 (152 mm)

Part No.	Conductors	Coil Diameter		Cord Diameter	
		Inch	mm	Inch	mm
651	2	0.471	11.96	0.135	3.43
652	4	0.592	15.04	0.150	3.81



Manhattan™ Cordsets

5000 V Retractable Test Lead Wire

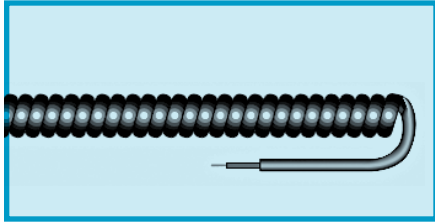

Operating Temperature

- -30°C to +60°C

Conductor Color Coding

- Black or red

Materials

- Stranded tinned copper conductors
- Rubber insulation
- Black jacket

Availability

1-piece packages
(Minimums may apply)

20 AWG (0.53 mm²)

Stranding: 41/36 (41 x 0.13 mm)
Insulation thickness: 0.050 (1.52 mm)
Jacket stripped 1.5" (38.1 mm); insulation stripped 0.50" (12.7 mm)

Part No.	Conductors	Coil Diameter		Cord Diameter		Power Rating	
		Inch	mm	Inch	mm	Watts	Amps
650*	1	0.580	14.73	0.165	4.19	1250	10

*Not UL Listed



Manhattan™ Cordsets

2000 V Portable Power Cable

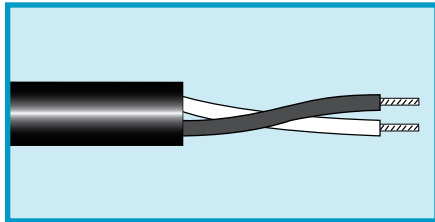

Type W
ICEA Accepted
NEMA Accepted

Operating Temperature
 • -30°C to +90°C

Conductor Color Coding
 • See tables

Materials

- Stranded bare copper conductors
- Thermoset insulation
- Black chlorinated polyethylene (CPE) jacket

Availability

Cut to specific length
 (Minimums may apply)

1-Conductor Cable

Part No.	Wire Size		Stranding		Insulation Thickness		Jacket Thickness		Nominal Diameter		Current-Carrying Capacity*
	AWG	mm ²	AWG	mm	Inch	mm	Inch	mm	Inch	mm	Amps
7431	6	13.57	133/27	133 x 0.36	0.063	1.60	0.080	2.03	0.510	12.95	85
7432	4	21.55	133/25	133 x 0.45	0.063	1.60	0.080	2.03	0.570	14.48	110
7434	2	34.45	133/23	133 x 0.57	0.063	1.60	0.080	2.03	0.660	16.76	150
7436	1/0	53.1	259/24	259 x 0.51	0.078	1.98	0.080	2.03	0.770	19.56	200
7437	2/0	67.08	259/23	259 x 0.57	0.078	1.98	0.080	2.03	0.820	20.83	235
7439	4/0	107	259/21	259 x 0.72	0.078	1.98	0.080	2.03	0.930	23.62	315

Conductor color coding: black.
 *Single conductor at 40°C ambient.

2-Conductor Cable

Part No.	Wire Size		Stranding		Insulation Thickness		Jacket Thickness		Nominal Diameter		Current-Carrying Capacity*
	AWG	mm ²	AWG	mm	Inch	mm	Inch	mm	Inch	mm	Amps
7680	8	8.61	133/29	133 x 0.28	0.063	1.60	0.095	2.41	0.810	20.57	50
7681	6	13.57	133/27	133 x 0.36	0.063	1.60	0.095	2.41	0.930	23.62	65
7682	4	21.55	133/25	133 x 0.45	0.063	1.60	0.110	2.79	1.080	27.43	90
7684	2	34.45	133/23	133 x 0.57	0.063	1.60	0.140	3.56	1.270	32.26	125

Conductor color coding: black, white.
 *Single conductor at 40°C ambient.

3-Conductor Cable

Part No.	Wire Size		Stranding		Insulation Thickness		Jacket Thickness		Nominal Diameter		Current-Carrying Capacity*
	AWG	mm ²	AWG	mm	Inch	mm	Inch	mm	Inch	mm	Amps
7700	8	8.61	133/29	133 x 0.28	0.063	1.60	0.140	3.56	0.910	23.11	50
7701	6	13.57	133/27	133 x 0.36	0.063	1.60	0.140	3.56	1.010	25.65	65
7702	4	21.6	133/25	133 x 0.45	0.063	1.60	0.140	3.56	1.170	29.72	85

Conductor color coding: black, white, green.
 *Single conductor at 40°C ambient.



Manhattan™ Cordsets

2000 V Portable Power Cable

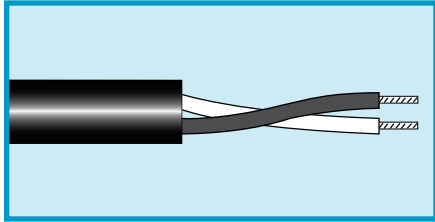

Type W
ICEA Accepted
NEMA Accepted

Operating Temperature

- -30°C to +90°C

Conductor Color Coding

- See tables

Materials

- Stranded bare copper conductors
- Thermoset insulation
- Black chlorinated polyethylene (CPE) jacket

Availability

Cut to specific length
 (Minimums may apply)

4-Conductor Cable

Part No.	Wire Size		Stranding		Insulation Thickness		Jacket Thickness		Nominal Diameter		Current-Carrying Capacity*
	AWG	mm ²	AWG	mm	Inch	mm	Inch	mm	Inch	mm	Amps
7800	8	8.61	133/29	133 x 0.28	0.063	1.60	0.110	2.79	0.990	25.15	40
7801	6	13.57	133/27	133 x 0.36	0.063	1.60	0.110	2.79	1.010	25.65	50

Conductor color coding: black, white, green, red.

*Single conductor at 40°C ambient.

4-Conductor Cable with Ground

Part No.	Wire Size		Stranding		Insulation Thickness		Nominal Diameter		Current-Carrying Capacity*	Ground Wire**	
	AWG	mm ²	AWG	mm	Inch	mm	Inch	mm	Amps	AWG	mm ²
7760	8	8.61	133/29	133 x 0.28	0.063	1.60	0.990	25.15	55	12	3.08
7761	6	13.6	133/0.0140	133 x 0.36	0.063	1.60	1.100	27.94	55	12	3.08
7762	4	21.6	133/0.0177	133 x 0.45	0.063	1.60	1.270	32.26	75	10	5.32
7764	2	34.4	133/0.0223	133 x 0.57	0.063	1.60	1.480	37.59	100	9	7.00
7765	1	42.4	133/0.0251	133 x 0.64	0.078	1.98	1.680	42.67	110	8	8.63
7766	1/0	53.0	259/24	259 x 0.51	0.078	1.98	1.790	45.47	130	7	10.5

Conductor color coding: black, white, red, orange.

*Single conductor at 40°C ambient.

**Ground wire is stranded bare copper with insulation.



Manhattan™ Thermocouple Cable

Temperature Measurement and Control

The measurement of temperature is one of the most vital functions in the control of manufacturing and processing operations. As demands for greater quality, reliability, and economy increase, the demands for more precise measurement and control increase. Newer and more sophisticated electronic circuitry is employed creating stringent demands on the wire and cable used to sense and transmit temperature measurements. To meet these ever-increasing demands, Alpha has a full line of thermocouple-grade wire and thermocouple extension wire and cable.

The Thermocouple

At the heart of all temperature measurements is the thermocouple. Although involving very complex design parameters, the fundamental concept of all thermocouples is the same. Two wires of dissimilar metal are joined together at one end. An increase in temperature creates an electromotive force (EMF) or signal, which is transmitted through these wires to a monitoring device which “reads” this signal and displays it on a previously calibrated meter or digital device.

The monitoring device is usually at a location some distance away from the actual thermocouple. To connect the thermocouple to the monitor requires wire or cable (for multiple thermocouple installations) that will maintain the integrity of the temperature-EMF

signal generated by the primary wires in the thermocouple.

Conductor Materials

The range and accuracy of temperature measurement are dependent on the conductor materials employed. Pairs of various metal alloys will react differently with changes in temperature.

The following tables give the temperature range and tolerances for the most popular alloy combinations. All Alpha thermocouple wire and cable is tested and calibrated to the standard limits of error as indicated. Where situations require closer tolerances, wire and cable calibrated to the special error limits is available under special order.

Limits of Error for Thermocouple Grade

ANSI Type	Material	Temperature Range (°C)	Standard Limits (±)	Special Limits (±)
J	Iron/Constantan	0 to 277	2.22°C	1.11°C
		277 to 760	0.75%	0.375%
K	Chromel/Alumel	0 to 277	2.22°C	1.11°C
		277 to 1260	0.75%	0.375%
T	Copper/Constantan	-184 to -101	—	1%
		-101 to -59	2%	1%
		-59 to 93	0.83°C	0.42°C
		93 to 371	0.75%	0.375%
E	Chromel/Constantan	0 to 316	1.67°C	1.25°C
		316 to 871	0.5%	0.375%
R	Platinum 13% Rhodium/ Platinum	0 to 538	1.39°C	—
		538 to 1482	0.25%	—
S	Platinum 10% Rhodium/ Platinum	0 to 538	1.39°C	—
		538 to 1482	0.25%	—

Manhattan™ Thermocouple Cable

Limits of Error for Thermocouple Extension Wire

ANSI Type	Material	Temperature Range (°C)	Standard Limits (±)	Special Limits (±)
JX	Iron/Constantan	-18 to 204	2.22°C	1.11°C
KX	Chromel/Alumel	-18 to 204	2.22°C	1.11°C
TX	Copper/Constantan	-59 to 93	0.83°C	0.42°C
EX	Chromel/Constantan	-18 to 204	2.22°C	1.11°C
RSX	Copper/Copper Alloy 11	24 to 204	6.67°C	—

Insulation and Jacket Material Properties

Material	Temperature (°C)		Mechanical			Chemical Resistance			
	Continuous	Intermittent	Flame	Abrasion	Flexibility	Solvents	Acids	Bases	Moisture
PVC	105	—	G	G	G	F	G	G	G
FEP	200	—	E	E	G	E	E	E	E
TFE Tape	260	—	E	E	E	E	E	E	E
Glass Braid	510	650	E	F/G	G	E	E	E	F/G
High-Temp Glass Braid	700	870	E	F/G	G	E	E	E	F/G

E = Excellent, G = Good, F = Fair

ISA/ANSI Thermocouple Color Coding

ANSI Type	Positive Wire		Negative Wire		Jacket Color		
	Material	Insul. Color	Material	Insul. Color	Grade	Tracer	Extension
J, JX	Iron	White	Constantan	Red	Brown	Black	Black
K, KX	Chromel	Yellow	Alumel	Red	Brown	Yellow	Yellow
T, TX	Copper	Blue	Constantan	Red	Brown	Blue	Blue
E, EX	Chromel	Violet	Constantan	Red	Brown	Violet	Violet
RX, SX	Copper	Black	Alloy 11	Red	—	—	Green

Manhattan™ Thermocouple Grade Wire

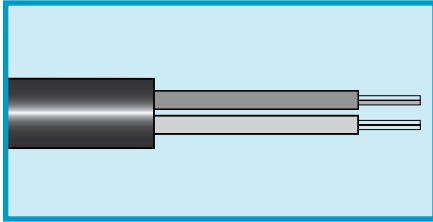

ISA MC 96.1

Operating Temperature

- -20°C to +510°C

Conductor Color Coding

- ISA color-coded insulation and jacket

Materials

- Solid or stranded alloy wire
- Braided fiberglass or FEP insulation
- Braided fiberglass or FEP jacket

Availability

100 ft (30.5 m)
500 ft (152 m)
1000 ft (305 m)
Bulk, cut to length
(Minimums may apply)

Duplex Parallel: Glass Braid Insulation, Glass Braid Jacket

Part No.	Conductor Size		Outer Dimension	
	AWG	mm ²	Inch	mm
Type J: Iron/Constantan				
5769/1	30	0.05	0.030 x 0.048	0.76 x 1.22
5766	24	0.20	0.040 x 0.068	1.02 x 1.73
5767H*	24	0.20	0.064 x 0.102	1.63 x 2.59
5763H*	20	0.51	0.084 x 0.142	2.13 x 3.61
5762S**	20	0.56	0.090 x 0.154	2.29 x 3.91
M9180012	20	0.51	0.060 x 0.106	1.53 x 2.69
Type K: Chromel/Alumel				
5776	24	0.20	0.040 x 0.068	1.02 x 1.73
5772S**	20	0.56	0.060 x 0.108	1.53 x 2.74
5773H *	20	0.51	0.084 x 0.142	2.13 x 3.61
M9180013	20	0.51	0.060 x 0.106	1.53 x 2.69
Type T: Copper/Constantan				
M9180014	20	0.51	0.060 x 0.106	1.53 x 2.69

*High temperature

**7/28 (7 x 0.32 mm) stranding

Duplex Parallel: FEP Insulation, FEP Jacket

Part No.	Conductor Size		Outer Dimension	
	AWG	mm ²	Inch	mm
Type J: Iron/Constantan				
M9160012	20	0.5	0.072 x 0.124	1.83 x 3.15
Type K: Chromel/Alumel				
M9160013	20	0.5	0.072 x 0.124	1.83 x 3.15
Type T: Copper/Constantan				
M9160014	20	0.5	0.072 x 0.124	1.83 x 3.15



Manhattan™ Thermocouple Extension Wire

Duplex Parallel, Unshielded

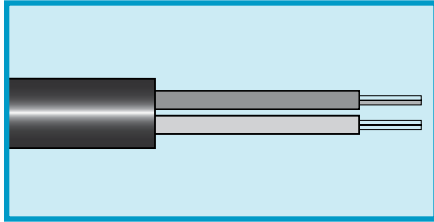

ISA MC 96.1

Operating Temperature

- -20°C to +105°C

Conductor Color Coding

- ISA color-coded insulation and jacket

Materials

- Solid or stranded alloy wire
- PVC, glass braid, or FEP insulation
- PVC, glass braid, or FEP jacket

Availability

100 ft (30.5 m)
 500 ft (152 m)
 1000 ft (305 m)
 Bulk, cut to length
 (Minimums may apply)

Part No.	Conductor Size		Outer Dimension	
	AWG	mm ²	Inch	mm
Type JX: Iron/Constantan				
5716	20	0.51	0.092 x 0.154	2.34 x 3.91
5710	14	2.08	0.124 x 0.218	3.15 x 5.54
Type KX: Chromel/Alumel				
5724	20	0.51	0.092 x 0.154	2.34 x 3.91
5724S*	20	0.56	0.098 x 0.166	2.49 x 4.22
5721	16	1.31	0.111 x 0.192	2.82 x 4.88
Type TX: Copper/Constantan				
5731	20	0.51	0.092 x 0.154	2.34 x 3.91
5731S*	20	0.56	0.098 x 0.166	2.49 x 4.22
5730	16	1.31	0.111 x 0.192	2.82 x 4.88
Type RSX: Copper/Copper Alloy 11				
5740	16	1.31	0.111 x 0.192	2.82 x 4.88

*7/28 (7 x 0.32 mm) stranding

Glass Braid Insulation, Glass Braid Jacket

Part No.	Conductor Size		Outer Dimension	
	AWG	mm ²	Inch	mm
Type JX: Iron/Constantan				
5714	16	1.31	0.085 x 0.150	2.16 x 3.81
Type SX: Copper/Copper Alloy 11				
5741H*	16	1.31	0.085 x 0.150	2.16 x 3.81

*High temperature

FEP Insulation, FEP Jacket

Part No.	Conductor Size		Outer Dimension	
	AWG	mm ²	Inch	mm
Type JX: Iron/Constantan				
5715	16	1.31	0.087 x 0.154	2.21 x 3.91



Manhattan™ Thermocouple Extension Wire

300 V, Single and Multipair, Unshielded and Foil Shield

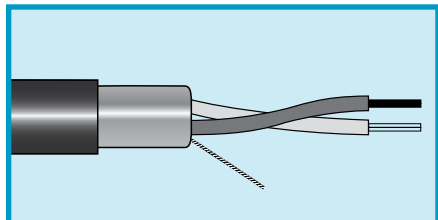

ISA MC 96.1
UL PLTC, ITC

Operating Temperature

- -20°C to +105°C
- -80°C to +200°C (High-temperature versions)

Conductor Color Coding

- ISA color-coded insulation and jacket

Materials

- Solid alloy wire
- PVC or FEP insulation
- Aluminum/polyester shield, 25% overlap min.
Foil facing inward
- Tinned copper drain wire
- PVC or FEP jacket

Availability

100 ft (30.5 m)
500 ft (152 m)
1000 ft (305 m)
Bulk, cut to length
(Minimums may apply)

Unshielded Single Pair, PVC Insulation, PVC Jacket
UL PLTC/ITC, 300 V, 105°C

Part No.	Conductor Size		Outer Dimension	
	AWG	mm ²	Inch	mm
Type EX: Chromel/Constantan				
M9000011	20	0.51	0.205	5.21
M9006011	16	1.31	0.235	5.97
Type JX: Iron/Constantan				
M9000012	20	0.51	0.205	5.21
M9006012	16	1.31	0.235	5.97
Type KX: Chromel/Alumel				
M9000013	20	0.51	0.205	5.21
M9006013	16	1.31	0.235	5.97
Type TX: Copper/Constantan				
M9000014	20	0.51	0.205	5.21
M9006014	16	1.31	0.235	5.97

Foil Shielded Individual and Overall, Twisted Pairs, PVC Insulation, PVC Jacket
UL PLTC/ITC, 300 V, 105°C

Part No.	Conductor Size		Pairs	Outer Dimension	
	AWG	mm ²		Inch	mm
Type EX: Chromel/Constantan					
M9020011	20	0.51	1	0.205	5.21
M9240041	20	0.51	4	0.440	11.18
M9240081	20	0.51	8	0.550	13.97
M9240121	20	0.51	12	0.665	16.89
M9240241	20	0.51	24	0.875	22.23
M9026011	16	1.31	1	0.235	5.97
Type JX: Iron/Constantan					
M9020012	20	0.51	1	0.205	5.21
M9240042	20	0.51	4	0.440	11.18
M9240082	20	0.51	8	0.550	13.97
M9240122	20	0.51	12	0.665	16.89
M9240162	20	0.51	16	0.740	18.80
M9240242	20	0.51	24	0.875	22.23
M9240362	20	0.51	36	1.010	25.65
M9026012	16	1.31	1	0.235	5.97
Type KX: Chromel/Alumel					
M9020013	20	0.51	1	0.205	5.21
M9240043	20	0.51	4	0.440	11.18
M9240083	20	0.51	8	0.550	13.97
M9240123	20	0.51	12	0.665	16.89
M9240243	20	0.51	24	0.875	22.23
M9026013	16	1.31	1	0.235	5.97
Type TX: Copper/Constantan					
M9020014	20	0.51	1	0.205	5.21
M9240044	20	0.51	4	0.440	11.18
M9240084	20	0.51	8	0.550	13.97
M9240124	20	0.51	12	0.665	16.89
M9240244	20	0.51	24	0.875	22.23
M9026014	16	1.31	1	0.235	5.97



Manhattan™ Thermocouple Extension Wire

300 V, Single and Multipair, Unshielded and Foil Shield

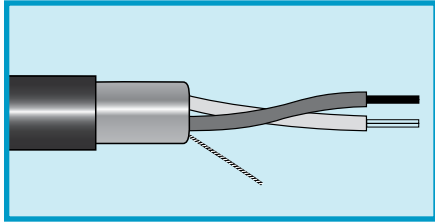

ISA MC 96.1
UL PLTC, ITC

Operating Temperature

- -20°C to +105°C
- -80°C to +200°C (High-temperature versions)

Conductor Color Coding

- ISA color-coded insulation and jacket

Materials

- Solid alloy wire
- PVC or FEP insulation
- Aluminum/polyester shield, 25% overlap min.
Foil facing inward
Tinned copper drain wire
- PVC or FEP jacket

Availability

100 ft (30.5 m)
500 ft (152 m)
1000 ft (305 m)
Bulk, cut to length
(Minimums may apply)

Foil Shielded Overall, Twisted Pairs, Solid Conductors, PVC Insulation, PVC Jacket UL PLTC, 300 V, 105°C

Part No.	Conductor Size		Pairs	Outer Dimension	
	AWG	mm ²		Inch	mm
Type JX: Iron/Constantan					
5711/2004	20	0.51	4	0.369	9.37
5711/2008	20	0.51	8	0.480	12.19
5711/2012	20	0.51	12	0.557	14.15
Type KX: Chromel/Alumel					
5712/2002	20	0.51	2	0.325	8.26
5712/2004	20	0.51	4	0.369	9.37
5712/2008	20	0.51	8	0.480	12.19
5712/2024	20	0.51	24	0.828	21.03
5712/2036	20	0.51	36	0.956	24.28
Type TX: Copper/Constantan					
5713/2004	20	0.51	4	0.369	9.37
5713/2012	20	0.51	12	0.557	14.15
5713/2024	20	0.51	24	0.828	21.03
Type RSX: Copper/Copper Alloy					
5714/1601	16	1.31	2	0.256	6.50

Foil Shielded Twisted Pairs, FEP Insulation, FEP Jacket High Temperature: -80°C to 200°C

Part No.	Conductor Size		Pairs	Outer Dimension	
	AWG	mm ²		Inch	mm
Type JX: Iron/Constantan					
5717/2001	20	0.51	1	0.150	3.81
5717/1601	16	1.31	1	0.188	4.78
Type KX: Chromel/Alumel					
5718/2001	20	0.51	1	0.150	3.81
5718/1601	16	1.31	1	0.188	4.78



Communication, Control, and Industrial Cable



Get control of demanding applications



The broad range of communication and control cables from Alpha Wire means you can find the right cable for your application. Our cables meet special needs, such as low-capacitance cables for extended transmission of digital signals, such as the extra flexibility of rubber insulation and jackets, or excellent shielding for electrically noisy environments.

We combine a wide range of insulation materials, shielding variations, conductor counts and gauges, as well as other options to create cables suited to any application. From traditional RS-232 connections to high-speed telemetry and data recording to high-fidelity microphone systems, our experience in materials and expertise in manufacturing means cable built to perform electrically, mechanically, and environmentally.

Our communication and control line includes six main categories:

- **Solar cable:** a full range of solar cables for power and control.
- **Industrial automation cable:** cable for common automation protocols such as ControlNet, DeviceNet, and PROFIBUS.
- **Flexible motor supply cable:** four-conductor double-shielded cable suited for light-duty flexing.
- **Communication and control:** round multiconductor and multipair cable in configurations suited to nearly any application.
- **Low-smoke, zero-halogen cable:** minimizes the effects from smoke and harmful corrosive gases in the event of combustion.
- **Flat cable:** planar multiconductor cable used primarily inside cabinets or equipment.

Solar Cable

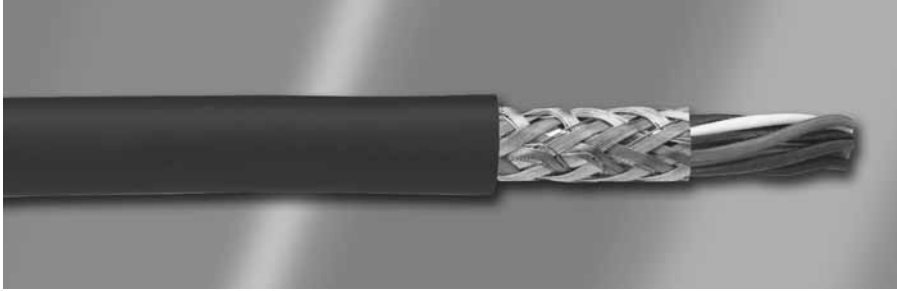

From residential rooftops to solar farms harvesting energy, our solar cables and photovoltaic wire are designed for the harsh environments of solar energy applications—the hot and cold of climate extremes, ozone and UV radiation, moisture, oil, and direct burial. Our specially formulated PVC jackets provide years of reliable service by withstanding the potential environments without failing or degrading.

A full range for power and control

No matter what your need in connecting solar power to the grid, we have wire and cable in a range of gauges and conductor counts to satisfy it.

Our cables meet regulatory and industry requirements for photovoltaic applications.

Applications

- Panel monitoring and control
- Panel to junction box
- Panel to collector
- Collector to inverter
- Grounding
- Motor supply

Photovoltaic Wire

For single-conductor needs, see page 417 for our line of photovoltaic wires.

Solar Cable

1000 V Braid Shield, Multiconductor, PVC/Nylon, PVC

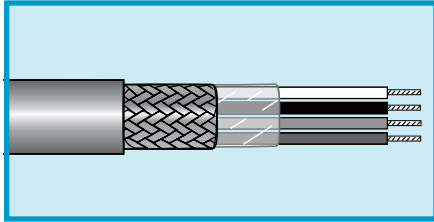

UL TC-ER
UL WTTTC (1000 V)
UL MTW
CSA AWM I/II A/B FT1

Operating Temperature

- -40°C to +90°C (static)
- -30°C to +90°C (dynamic)
- +105°C (CSA)

Conductor Color Coding

- Chart F (page 532)

Materials

- Stranded bare copper conductors
- PVC/nylon insulation
- Clear polyester wrap
- Tinned copper braid shield, 85% coverage
- Green PVC jacket

Features

- UL Sunlight Resistant
- UL Oil Res. I
- UL Direct Burial
- Suitable for use in Class I, Division 2 locations per Article 501 of the National Electric Code

Availability

Bulk, cut to length

FIT® Tubing Recommendations

- FIT-260: Cross-linked polyolefin for ground identification
- FIT-300: Dual-wall polyolefin with meltable inner wall
- FIT-750: Bonding adhesive-lined cross-linked polyolefin

18 AWG (0.96 mm²)

Stranding: 19/30 (19 x 0.25 mm)
 Insulation thickness: 0.016 (0.41 mm) PVC/0.005 (0.12 mm) nylon

Part No.	Conductors	Nominal Diameter		Jacket Thickness	
		Inch	mm	Inch	mm
SPM1803CY	3	0.329	8.36	0.050	1.27
SPM1804CY	4	0.354	8.99	0.050	1.27
SPM1805CY	5	0.381	9.68	0.050	1.27
SPM1807CY	7	0.409	10.39	0.050	1.27
SPM1809CY	9	0.466	11.84	0.050	1.27

16 AWG (1.32 mm²)

Stranding: 26/30 (26 x 0.25 mm)
 Insulation thickness: 0.016 (0.41 mm) PVC/0.005 (0.12 mm) nylon

Part No.	Conductors	Nominal Diameter		Jacket Thickness	
		Inch	mm	Inch	mm
SPM1603CY	3	0.351	8.92	0.050	1.27
SPM1604CY	4	0.378	9.60	0.050	1.27
SPM1605CY	5	0.408	10.36	0.050	1.27
SPM1607CY	7	0.439	11.15	0.050	1.27
SPM1609CY	9	0.509	12.93	0.050	1.27

14 AWG (2.08 mm²)

Stranding: 41/30 (41 x 0.25 mm)
 Insulation thickness: 0.016 (0.41 mm) PVC/0.005 (0.12 mm) nylon

Part No.	Conductors	Nominal Diameter		Jacket Thickness	
		Inch	mm	Inch	mm
SPM1403CY	3	0.381	9.68	0.050	1.27
SPM1404CY	4	0.412	10.46	0.050	1.27
SPM1405CY	5	0.446	11.33	0.050	1.27
SPM1407CY	7	0.481	12.22	0.050	1.27
SPM1409CY	9	0.590	14.99	0.065	1.65

12 AWG (3.29 mm²)

Stranding: 65/30 (65 x 0.25 mm)
 Insulation thickness: 0.016 (0.41 mm) PVC/0.005 (0.12 mm) nylon

Part No.	Conductors	Nominal Diameter		Jacket Thickness	
		Inch	mm	Inch	mm
SPM1203CY	3	0.422	10.72	0.050	1.27
SPM1204CY	4	0.458	11.63	0.050	1.27
SPM1205CY	5	0.497	12.62	0.050	1.27
SPM1207CY	7	0.574	14.58	0.065	1.65
SPM1209CY	9	0.659	16.74	0.065	1.65



Solar Cable

1000 V Unshielded, Multiconductor, PVC/Nylon, PVC

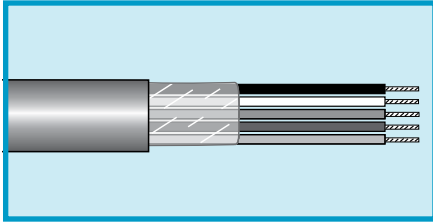

UL TC-ER
UL WTTTC (1000 V)
UL MTW
CSA AWM I/II A/B FT1

Operating Temperature

- -40°C to +90°C (static)
- -30°C to +90°C (dynamic)
- +105°C (CSA)

Conductor Color Coding

- Chart F (page 532)

Materials

- Stranded bare copper conductors
- PVC/nylon insulation
- Clear polyester wrap
- Green PVC jacket

Features

- UL Sunlight Resistant
- UL Oil Res. I
- UL Direct Burial
- Suitable for use in Class I, Division 2 locations per Article 501 of the National Electric Code

Availability

Bulk, cut to length

FIT® Tubing Recommendations

- FIT-260: Cross-linked polyolefin for ground identification
- FIT-300: Dual-wall polyolefin with meltable inner wall
- FIT-750: Bonding adhesive-lined cross-linked polyolefin

18 AWG (0.96 mm²)

Stranding: 19/30 (19 x 0.25 mm)
Insulation thickness: 0.016 (0.41 mm) PVC/0.005 (0.12 mm) nylon

Part No.	Conductors	Nominal Diameter		Jacket Thickness	
		Inch	mm	Inch	mm
SPM1803	3	0.301	7.65	0.050	1.27
SPM1804	4	0.326	8.28	0.050	1.27
SPM1805	5	0.353	8.97	0.050	1.27
SPM1807	7	0.381	9.68	0.050	1.27
SPM1809	9	0.438	11.13	0.050	1.27

16 AWG (1.32 mm²)

Stranding: 26/30 (26 x 0.25 mm)
Insulation thickness: 0.016 (0.41 mm) PVC/0.005 (0.12 mm) nylon

Part No.	Conductors	Nominal Diameter		Jacket Thickness	
		Inch	mm	Inch	mm
SPM1603	3	0.323	8.20	0.050	1.27
SPM1604	4	0.350	8.89	0.050	1.27
SPM1605	5	0.380	9.65	0.050	1.27
SPM1607	7	0.411	10.44	0.050	1.27
SPM1609	9	0.475	12.07	0.050	1.27

14 AWG (2.08 mm²)

Stranding: 41/30 (41 x 0.25 mm)
Insulation thickness: 0.016 (0.41 mm) PVC/0.005 (0.12 mm) nylon

Part No.	Conductors	Nominal Diameter		Jacket Thickness	
		Inch	mm	Inch	mm
SPM1403	3	0.353	8.97	0.050	1.27
SPM1404	4	0.384	9.75	0.050	1.27
SPM1405	5	0.418	10.62	0.050	1.27
SPM1407	7	0.453	11.51	0.050	1.27
SPM1409	9	0.556	14.12	0.065	1.65

12 AWG (3.29 mm²)

Stranding: 65/30 (65 x 0.25 mm)
Insulation thickness: 0.016 (0.41 mm) PVC/0.005 (0.12 mm) nylon

Part No.	Conductors	Nominal Diameter		Jacket Thickness	
		Inch	mm	Inch	mm
SPM1203	3	0.394	10.01	0.050	1.27
SPM1204	4	0.430	10.92	0.050	1.27
SPM1205	5	0.469	11.91	0.050	1.27
SPM1207	7	0.510	12.95	0.050	1.27
SPM1209	9	0.625	15.88	0.065	1.65



Industrial Automation Cable

Seamless communication for robust industrial environments

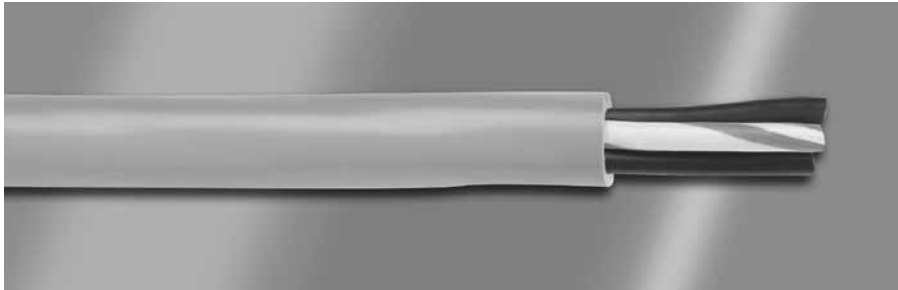

Whether you are designing a device for error proofing to increase quality or motion sensing to improve safety, trust Alpha Wire for all your Industrial Automation needs.

As industrial automation systems continue to increase in complexity, we understand the challenges that engineers and manufacturers face in designing and interconnecting system components from sensors to top-level controllers. Our range of industrial automation cables combines the industry-leading quality and exceptional reliability you expect with Alpha Wire with the performance to meet the rigorous requirements of the major automation communication architectures.

ControlNet™

Low-loss RG-6/U coax designed to meet the high-speed, time-critical requirements of modern ControlNet factory-floor automation systems.

RS-485

Bringing proven data transmission protocol to the factory floor, rugged RS-485 cables reduce electrical noise sensitivity to keep reliability and performance at world-class levels.

DeviceNet™

Meeting ODVA thick and thin specifications, the cables comply with Allen-Bradley 1485 CPI-A and 1485 CPI-C, and support high data rates (500 kb/s at 100 m and 125 kb/s at 500 m).

Fieldbus and PROFIBUS®

A complete family meets ruggedness, performance, and quality requirements of almost any fieldbus and PROFIBUS application environment.

Industrial Twinax

A robust physical media for the transmission of PLC/DCS signals in real-time, high-throughput applications, including Allen-Bradley Data Highway networks. The cables may be installed in the same tray or conduit as 600-volt power cable.

ControlNet

300 V, RG-6/U Coaxial Cable, Double Braid and Foil Shielded

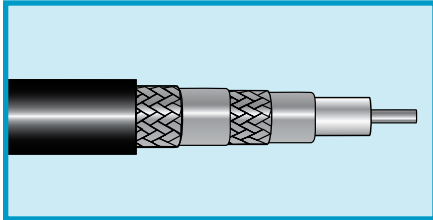

UL CL2R
UL CMR
CSA CMG FT4

Operating Temperature

- -30°C to +75°C

Materials

- Solid bare Copperweld conductor
- Foam polyethylene insulation
- Shielding: double braid and foil
 Foil +60% aluminum braid +
 foil +40% aluminum braid
- Black PVC jacket

Features

- UL Sunlight Resistant
- 75-ohm nominal impedance
- 82% velocity of propagation
- 16.2 pF/ft (53.1 pF/m) nominal capacitance

Availability

100 ft (30.5 m)
 500 ft (152 m)
 1000 ft (305 m)

FIT® Tubing Recommendations

- FIT-221: General-purpose, cross-linked polyolefin
- FIT-321: Medium-wall, adhesive-lined, cross-linked polyolefin

Part No.	Nominal Diameter		Center Conductor		Nominal Impedance (ohms)
	Inch	mm	AWG	mm ²	
6458	0.298	7.57	18	0.82	75

Frequency (MHz)	Nominal Attenuation	
	Attenuation, Nom.	
	dB/100 ft	dB/100 m
1	0.35	1.1
2	0.38	1.2
5	0.45	1.5
10	0.59	1.9
20	0.86	2.8
50	1.37	4.5
100	1.97	6.5
200	2.82	9.3
300	3.48	11.4
400	4.04	13.3



DeviceNet

300 V Power and Data, Class 2, ODVA Thick and Thin Trunks

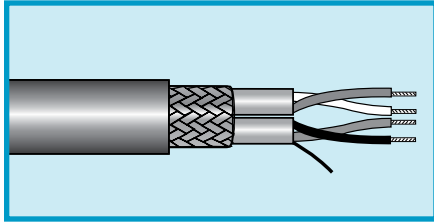

Part No.	Type	Pairs	Nominal Diameter	
			Inch	mm
6451	Thick	1 Power: 15 AWG (1.75 mm ²), 19/0.0135 (19 x 0.35 mm) stranding	0.480	12.19
		1 Data: 18 AWG (0.96 mm ²), 19/30 (19 x 0.25 mm) stranding		
6452	Thin	1 Power: 22 AWG (0.38 mm ²), 19/34 (19 x 0.16 mm) stranding	0.280	7.11
		1 Data: 24 AWG (0.24 mm ²), 19/36 (19 x 0.13 mm) stranding		

- UL CMG
- UL PLTC-ER (Thick)
- UL CL2 (Thin)
- CSA CMG FT4
- CSA AWM I/II A/B FT4

Operating Temperature

- -20°C to +75°C (static)
- 0°C to +80°C (dynamic)

Conductor Color Coding

- Black-red power
- Blue-white data

Materials

- Tinned copper conductors
- Each pair individually foil shielded
- PVC insulation (power pair)
- Foam HDPE insulation (data pair)
- 65% tinned copper braid overall
- Slate PVC jacket

Features

- Oil resistant
- UL Sunlight Resistant
- 120-ohm nominal impedance (data pair)
- Compliant with Allen-Bradley part numbers 1485 CPI-A and 1485 CPI-C

Availability

- 100 ft (30.5 m)
- 500 ft (152 m)
- 1000 ft (305 m)

FIT® Tubing Recommendations

- FIT-221: General-purpose, cross-linked polyolefin
- FIT-321: Medium-wall, adhesive-lined, cross-linked polyolefin



Fieldbus

300 V Single-Pair Cable, Fieldbus Types A and B

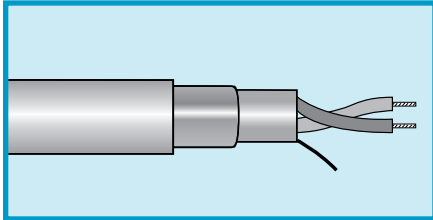

Part No.	Fieldbus Type	Pairs	Conductor		Stranding		Nominal Diameter	
			AWG	mm ²	AWG	mm	Inch	mm
6459	A	1	18	0.90	7/26	7 x 0.40	0.253	6.43
6460	B	1	22	0.33	7/0.0096	7 x 0.24	0.196	4.97

UL PLTC-ER
UL CM
UL ITC
CSA CM

Operating Temperature

- -30°C to +105°C

Conductor Color Coding

- Blue-orange

Materials

- Tinned copper conductors
- Polyolefin insulation
- Foil shield
- Orange PVC jacket

Features

- UL Sunlight Resistant
- 100-ohm nominal impedance

Availability

100 ft (30.5 m)
 500 ft (152 m)
 1000 ft (305 m)

FIT® Tubing Recommendations

- FIT-221: General-purpose, cross-linked polyolefin
- FIT-321: Medium-wall, adhesive-lined, cross-linked polyolefin



High-Speed Fieldbus

300 V Single-Pair Cable

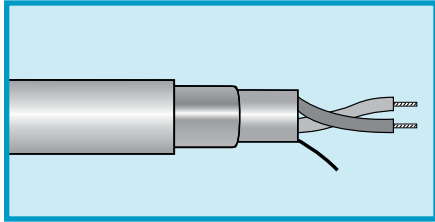

Part No.	Pairs	Conductor		Stranding		Nominal Diameter	
		AWG	mm ²	AWG	mm	Inch	mm
6461	1	22	0.35	7/30	7 x 0.25	0.351	8.92

UL PLTC

UL CM

CSA CM

Operating Temperature

- -40°C to +75°C

Conductor Color Coding

- Blue-orange

Materials

- Tinned copper conductors
- Foam high-density polyethylene insulation
- Foil shield
- Orange PVC jacket

Features

- UL Sunlight Resistant
- 150-ohm nominal impedance

Availability

100 ft (30.5 m)

500 ft (152 m)

1000 ft (305 m)

FIT® Tubing Recommendations

- FIT-221: General-purpose, cross-linked polyolefin
- FIT-321: Medium-wall, adhesive-lined, cross-linked polyolefin



PROFIBUS-DP

300 V Single-Pair Cable

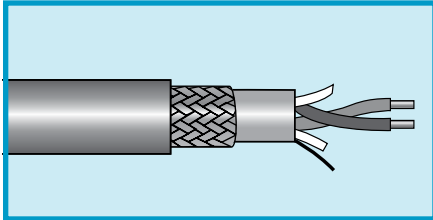

Part No.	Pairs	Conductor		Stranding		Nominal Diameter	
		AWG	mm ²	AWG	mm	Inch	mm
6462	1	22	0.32	Solid		0.315	8.00
6463	1	22	0.35	7/30	7 x 0.25	0.315	8.00

UL AWM 20201 (6462 only)

UL PLTC

UL CMG

CSA CMG FT4

Operating Temperature

- -30°C to +75°C (PLTC, CMG)
- -30°C to +60°C (AWM)

Conductor Color Coding

- Red-green

Materials

- Tinned solid or stranded copper conductors
- Foam high-density polyethylene insulation
- Foil + 65% tinned copper braid shield
- Purple PVC jacket

Features

- UL Sunlight Resistant
- 150-ohm nominal impedance

Availability

100 ft (30.5 m)

500 ft (152 m)

1000 ft (305 m)

FIT® Tubing Recommendations

- FIT-221: General-purpose, cross-linked polyolefin
- FIT-321: Medium-wall, adhesive-lined, cross-linked polyolefin



RS-485 Cable

300 V Foil + Braid, Multipair

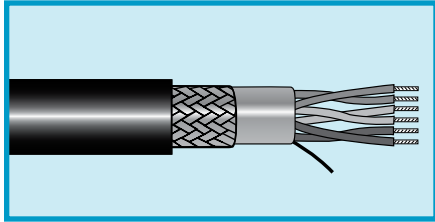

UL CM, CMG
UL TC, PLTC
CSA CM, CMG FT1

Operating Temperature

- -20°C to +60°C

Conductor Color Coding

- Chart M (page 530), except 6454

Materials

- Tinned copper conductors
- Foam high-density polyethylene insulation
- Foil + 65% tinned copper braid shield
- Black PVC jacket

Features

- UL Sunlight Resistant
- 120-ohm nominal impedance

Availability

100 ft (30.5 m)
 500 ft (152 m)
 1000 ft (305 m)

FIT® Tubing Recommendations

- FIT-221: General-purpose, cross-linked polyolefin
- FIT-321: Medium-wall, adhesive-lined, cross-linked polyolefin

22 AWG (0.35 mm ²)							
Stranding: 7/30 (7 x 0.25 mm)							
Part No.	Pairs	Nominal Diameter		Insulation Thickness		Jacket Thickness	
		Inch	mm	Inch	mm	Inch	mm
6453	1	0.284	7.21	0.028	0.71	0.042	1.07
6454*	1.5	0.300	7.62	0.032	0.81	0.042	1.07
6455	2	0.408	10.36	0.024	0.61	0.053	1.35
6456	3	0.414	10.52	0.022	0.56	0.053	1.35
6457	4	0.448	11.38	0.022	0.56	0.053	1.35

*Conductor color coding: white/orange-orange/white pair, white-blue single conductor.



Industrial Twinax

600 V Foil + Braid Shield, Single Pair

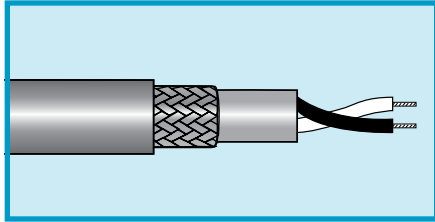

Part No.	Pairs	Conductor		Stranding		Nominal Diameter	
		AWG	mm ²	AWG	mm	Inch	mm
6450	1	18	0.90	7/26	7 x 0.40	0.324	8.23

UL TC, PLTC, ITC
UL CMG
CSA CMG FT4

Operating Temperature

- -40°C to +75°C

Conductor Color Coding

- Blue-white

Materials

- Tinned stranded copper conductors
- Flame-resistant polypropylene insulation
- Foil + 55% tinned copper braid shield
- Blue PVC jacket

Features

- UL Sunlight Resistant
- 78-ohm nominal impedance
- Meets the requirements of Allen-Bradley Data Highway Networks

Availability

100 ft (30.5 m)
 500 ft (152 m)
 1000 ft (305 m)

FIT® Tubing Recommendations

- FIT-221: General-purpose, cross-linked polyolefin
- FIT-321: Medium-wall, adhesive-lined, cross-linked polyolefin



Flexible Motor Supply Cable

Light Duty Flexing

600 V Foil/Braid, Four Conductor

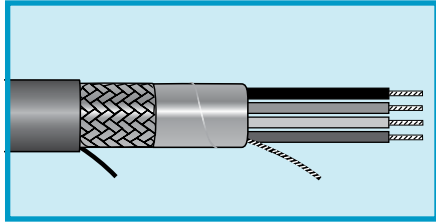

UL TC-ER
 UL MTW
 UL WTTCC
 CSA AWM I/II A/B FT4
 CE

Operating Temperature

- -5°C to +90°C (flexing)
- -20°C to +90°C (stationary)

Conductor Color Coding

- One yellow/green and three numbered black

Materials

- Finely stranded bare copper conductors
- PVC/nylon insulation
- Foil + braid shield
 Aluminum/polyester/aluminum foil shield, with 25% overlap and four tinned copper drain wires
- Tinned copper braid with 70% coverage
- Black PVC jacket

Voltage

- 600 V (UL TC-ER, MTW)
- 1000 V (UL WTTCC)

Availability

Bulk, cut to length

FIT® Tubing Recommendations

- FIT-321: Medium-wall, adhesive-lined, cross-linked polyolefin
- FIT-600: Highly flexible, cross-linked elastomer

16 to 6 AWG (1.49 to 5.33 mm²)

Part No.	Conductors	Wire Size		Stranding		Nominal Diameter		Jacket Thickness		Insulation Thickness	
		AWG	mm ²	AWG	mm	Inch	mm	Inch	mm	Inch	mm
5660	4	16	1.32	26/30	26 x 0.25	0.381	9.67	0.050	1.27	0.016	0.40
5661	4	14	2.08	41/30	41 x 0.25	0.418	10.61	0.050	1.27	0.016	0.40
5662	4	12	3.30	65/30	65 x 0.25	0.464	11.78	0.050	1.27	0.016	0.40
5663	4	10	5.32	105/30	105 x 0.25	0.579	14.70	0.063	1.60	0.022	0.55
5664	4	8	8.52	168/30	168 x 0.25	0.760	19.30	0.063	1.60	0.032	0.81
5665	4	6	13.49	266/30	266 x 0.25	0.901	22.88	0.083	2.10	0.032	0.81



A Full Range of Communication and Control



Our line-up of standard communication and control cables gives you maximum choice and fewer tradeoffs. By offering you a comprehensive collection of insulation/jacketing materials, shielding options, and conductor counts, you can easily select the cable that meets your most demanding needs. We have cables that go beyond the ordinary to satisfy rigorous requirements of EMI performance, transmission distances, flexibility, and temperature extremes.

Communication and control typical applications:

- Audio systems: speakers, microphones, intercoms
- Broadcast and studio
- Data transmission: RS-232, 422, 485
- CAD/CAM
- Computer peripherals
- Business machines
- Security systems: alarms, cameras, sensors
- Control systems
- Instrumentation systems
- Point-of-sale systems
- Banking systems

Communication and control key features:

- 1 - 50 conductors, 1 - 50 pairs
- Wide range of insulation/jacket materials:
 - PVC
 - Irradiated PVC
 - Plenum-rated PVC
 - Semirigid PVC
 - Rubber
 - Polyethylene
 - Polypropylene
 - Foam PP and PE
 - PTFE/FEP
 - LSZH
- Low-capacitance cables for improved transmission distances and signal integrity

Flexible shielding options:

- Unshielded
- Overall foil shield
- Overall foil/braid
- Individual foil-shielded pairs
- Individual foil-shielded pairs with overall foil/braid

Communication and Control Cable

300 V Unshielded, Multiconductor, LSZH

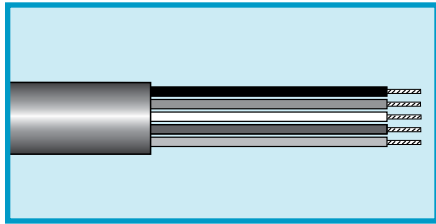

**UL CM VW-1
CSA CMG FT4**

Operating Temperature

- -20°C to +75°C

Materials

- Stranded tinned copper conductors
- LSZH insulation
- Slate LSZH jacket

LSZH Properties

- LSZH Flammability: Passes IEC 60332-1
- LSZH Acid Gas Generation: Passes IEC 60754-1 and 60754-2
- LSZH Smoke Emission: Passes IEC 61034-2

Alpha Wire's LSZH communication and control cable combines LSZH-rated insulation and jackets with the rugged performance you expect from Alpha. The specially formulated LSZH material minimizes the effects from smoke and harmful corrosive gases in the event of combustion. Low smoke means easier visibility in exiting the area and reduced danger of smoke inhalation, while low toxicity means no harm to people from halogenated gases.

LSZH Unshielded Multiconductor Conductor Color Coding: Chart D

22 AWG (0.35 mm²)

Stranding: 7/30 (7 x 0.25 mm)
Insulation thickness: 0.010 (0.25 mm)

Part No.	Conductors	Nominal Diameter		Jacket Thickness	
		Inch	mm	Inch	mm
1172L	2	0.161	4.09	0.028	0.71
1173L	3	0.169	4.29	0.028	0.71
1174L	4	0.189	4.80	0.028	0.71
1175L	5	0.201	5.11	0.028	0.71
1176L	6	0.209	5.31	0.030	0.76
1177L	7	0.209	5.31	0.030	0.76
1178L	8	0.220	5.59	0.030	0.76
1179L	9	0.249	6.32	0.032	0.81
1180L	10	0.260	6.60	0.035	0.88

20 AWG (0.56 mm²)

Stranding: 7/28 (0.32 mm)
Insulation thickness: 0.016 (0.40 mm)

Part No.	Conductors	Nominal Diameter		Jacket Thickness	
		Inch	mm	Inch	mm
1895L	2	0.181	4.60	0.018	0.45
1896L	3	0.189	4.80	0.020	0.50
1896/4L	4	0.209	5.31	0.020	0.50
1896/5L	5	0.232	5.89	0.020	0.50
1896/6L	6	0.276	7.01	0.020	0.50



Communication and Control Cable

300 V Foil Shielded, Multipair, LSZH

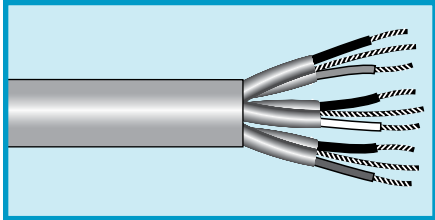
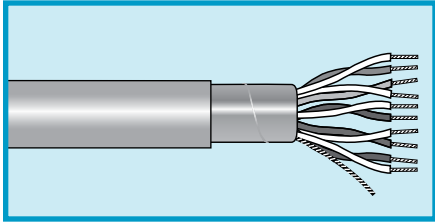

Alpha Wire's LSZH communication and control cable combines LSZH-rated insulation and jackets with the rugged performance you expect from Alpha. The specially formulated LSZH material minimizes the effects from smoke and harmful corrosive gases in the event of combustion. Low smoke means easier visibility in exiting the area and reduced danger of smoke inhalation, while low toxicity means no harm to people from halogenated gases.

**UL CM VW-1
CSA CMG FT4**

Operating Temperature

- 20°C to +75°C

Materials

- Stranded tinned copper conductors
- LSZH insulation (Polypropylene insulation for individually foil shielded pairs)
- Aluminum/polyester shielding, with 25% overlap min. Foil facing inward
- Tinned copper drain wire sized the same as the conductors
- Slate LSZH jacket

LSZH Properties

- **LSZH Flammability:** Passes IEC 60332-1
- **LSZH Acid Gas Generation:** Passes IEC 60754-1 and 60754-2
- **LSZH Smoke Emission:** Passes IEC 61034-2

LSZH Overall Foil Shielded Multipair Conductor Color Coding: Chart A

24 AWG (0.22 mm²)

Stranding: 7/32 (7 x 0.20 mm)
Insulation thickness: 0.010 (0.25 mm)

Part No.	Pairs	Nominal Diameter		Jacket Thickness	
		Inch	mm	Inch	mm
5471L	1	0.161	4.09	0.028	0.71
5472L	2	0.209	5.31	0.028	0.71
5473L	3	0.228	5.79	0.028	0.71
5474L	4	0.240	6.10	0.028	0.71
5475L	5	0.272	6.91	0.030	0.76
5476L	6	0.299	7.59	0.030	0.76
5477L	7	0.299	7.59	0.030	0.76
5478L	8	0.319	8.10	0.032	0.81
5479L	9	0.339	8.61	0.032	0.81
5480L	10	0.378	9.60	0.032	0.81

LSZH Individually Foil-Shielded Pair Conductor Color Coding: Chart A

22 AWG (0.35 mm²)

Stranding: 7/30 (7 x 0.25 mm)
Insulation thickness: 0.010 (0.25 mm)

Part No.	Pairs	Nominal Diameter		Jacket Thickness	
		Inch	mm	Inch	mm
2466L**	2	0.161	4.09	0.014	0.35
6010L	3	0.299	7.59	0.047	1.19
2463L**	4	0.242	6.15	0.020	0.50
6012L	6	0.386	9.80	0.040	1.01
6014L	9	0.441	11.20	0.040	1.01
6017L	12	0.492	12.50	0.040	1.01

*Conductor color coding: 1 Red-Black, 2 Green-White, White/Red-White/Black, 4 White/Green-White/Yellow.

†0.009 (0.23) insulation thickness.

**0.008 (0.20) insulation thickness.



Communication and Control

300 V Unshielded, Multiconductor, PVC, PVC

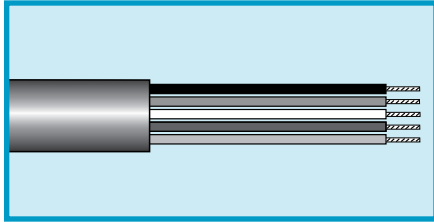

UL AWM 2576 (150 V) VW-1
UL CM
CSA CMG FT4

Operating Temperature

- -20°C to +80°C (AWM)
- -20°C to +75°C (CM)
- -20°C to +60°C (CMG)

Conductor Color Coding

- Chart D (page 531)

Materials

- Stranded or solid tinned copper conductors
- PVC insulation
- Slate PVC jacket

Availability

100 ft (30.5 m)
 500 ft (152 m)
 1000 ft (305 m)

22 AWG (0.35 mm²)

Stranding: 7/30 (7 x 0.25 mm)
 Insulation thickness: 0.010 (0.25 mm)

Part No.	Conductors	Nominal Diameter		Jacket Thickness	
		Inch	mm	Inch	mm
1172C	2	0.164	4.17	0.032	0.81
1173C	3	0.172	4.37	0.032	0.81
1174C	4	0.185	4.70	0.032	0.81
1175C	5	0.200	5.08	0.032	0.81
1176C	6	0.215	5.46	0.032	0.81
1177C	7	0.215	5.46	0.032	0.81
1178C	8	0.230	5.84	0.032	0.81
1179C	9	0.246	6.25	0.032	0.81
1180C	10	0.264	6.71	0.032	0.81
1181C	12	0.272	6.91	0.032	0.81
1181/15C	15	0.294	7.47	0.032	0.81
1181/20C	20	0.326	8.28	0.032	0.81
1181/25C	25	0.364	9.25	0.032	0.81
1181/30C	30	0.385	9.78	0.032	0.81
1181/40C	40	0.429	10.90	0.032	0.81
1181/50C	50	0.478	12.14	0.035	0.89
1181/60C	60	0.520	13.21	0.035	0.89

22 AWG (0.32 mm²)

Stranding: Solid
 Insulation thickness: 0.010 (0.25 mm)

Part No.	Conductors	Nominal Diameter		Jacket Thickness	
		Inch	mm	Inch	mm
1793C	2	0.157	3.99	0.032	0.81



Communication and Control

300 V Unshielded, Multiconductor, PVC, PVC

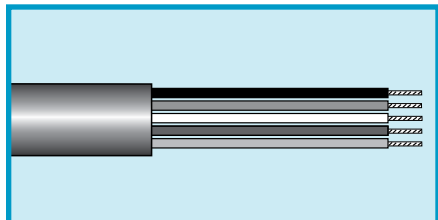

UL AWM 2509 VW-1
UL CM
CSA CMG FT4

Operating Temperature

- -20°C to +80°C (AWM)
- -20°C to +75°C (CM)
- -20°C to +60°C (CMG)

Conductor Color Coding

- Chart D (page 531)

Materials

- Stranded tinned copper conductors
- PVC insulation
- Slate PVC jacket

Availability

100 ft (30.5 m)
 500 ft (152 m)
 1000 ft (305 m)

20 AWG (0.56 mm²)

Stranding: 7/28 (7 x 0.32 mm)
 Insulation thickness: 0.016 (0.41 mm)

Part No.	Conductors	Nominal Diameter		Jacket Thickness	
		Inch	mm	Inch	mm
1895C	2	0.180	4.57	0.020	0.51
1896C	3	0.191	4.85	0.020	0.51
1896/4C	4	0.209	5.31	0.020	0.51
1896/5C	5	0.230	5.84	0.020	0.51
1896/6C	6	0.251	6.38	0.020	0.51
1896/7C	7	0.251	6.38	0.020	0.51
1896/8C	8	0.273	6.93	0.020	0.51
1896/9C	9	0.301	7.65	0.023	0.58
1896/10C	10	0.320	8.13	0.020	0.51
1896/12C	12	0.331	8.41	0.020	0.51
1896/15C	15	0.382	9.70	0.030	0.76

18 AWG (0.81 mm²)

Stranding: 16/30 (16 x 0.25 mm)
 Insulation thickness: 0.016 (0.41 mm)

Part No.	Conductors	Nominal Diameter		Jacket Thickness	
		Inch	mm	Inch	mm
1897C	2	0.198	5.03	0.020	0.51
1898C	3	0.210	5.33	0.020	0.51
1898/4C	4	0.231	5.87	0.020	0.51
1898/5C	5	0.254	6.45	0.020	0.51
1898/6C	6	0.278	7.06	0.020	0.51
1898/7C	7	0.278	7.06	0.020	0.51
1898/8C	8	0.313	7.95	0.025	0.64
1898/9C	9	0.337	8.56	0.025	0.64
1898/10C	10	0.366	9.30	0.025	0.64
1898/12C	12	0.378	9.60	0.025	0.64
1898/15C	15	0.423	10.74	0.030	0.76
1898/19C	19	0.455	11.56	0.030	0.76
1898/25C	25	0.544	13.82	0.035	0.89

16 AWG (1.32 mm²)

Stranding 19/0.0117 (19 x 0.29 mm)
 Insulation thickness: 0.016 (0.41 mm)

Part No.	Conductors	Nominal Diameter		Jacket Thickness	
		Inch	mm	Inch	mm
1899C	2	0.222	5.64	0.020	0.51
1899/3C	3	0.236	5.99	0.020	0.51
1899/4C	4	0.260	6.60	0.020	0.51



Communication and Control

300 V Unshielded, Multiconductor, PVC, PVC

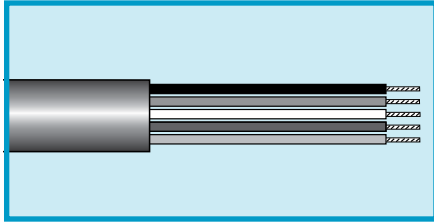

UL CL2 VW-1
CSA AWM I/II A/B FT1

Operating Temperature

- -20°C to +80°C (AWM)
- -20°C to +75°C (CL2)

Conductor Color Coding

- Chart D (page 531)

Materials

- Stranded tinned copper conductors
- PVC insulation
- Slate PVC jacket

Availability

100 ft (30.5 m)
500 ft (152 m)
1000 ft (305 m)

14 AWG (2.09 mm²)

Stranding: 41/30 (41 x 0.25 mm)
Insulation thickness: 0.020 (0.51 mm)

Part No.	Conductors	Nominal Diameter		Jacket Thickness	
		Inch	mm	Inch	mm
1891C	2	0.268	6.81	0.020	0.51
1891/3C	3	0.286	7.26	0.020	0.51

12 AWG (3.31 mm²)

Stranding: 65/30 (65 x 0.25 mm)
Insulation thickness: 0.020 (0.51 mm)

Part No.	Conductors	Nominal Diameter		Jacket Thickness	
		Inch	mm	Inch	mm
1892C	2	0.312	7.92	0.023	0.58
1892/3C	3	0.333	8.46	0.023	0.58

Communication and Control

600 V Unshielded, Multiconductor, PVC, PVC

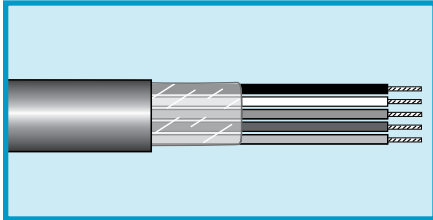

UL AWM 2463 VW-1

Operating Temperature

- 20°C to +80°C

Conductor Color Coding

- Chart F (page 532)

Materials

- Stranded tinned copper conductors
- PVC insulation
- Clear polyester wrap
- Slate PVC jacket

Availability

100 ft (30.5 m)
500 ft (152 m)
1000 ft (305 m)

16 AWG (1.32 mm²)

Stranding 19/0.0117 (19 x 0.29 mm)
Insulation Thickness 0.032 (0.81 mm)

Part No.	Conductors	Nominal Diameter		Jacket Thickness	
		Inch	mm	Inch	mm
1064	4	0.395	10.03	0.047	1.19
1065	5	0.430	10.92	0.047	1.19
1067	7	0.468	11.89	0.047	1.19
1069	9	0.577	14.66	0.063	1.60
1072	12	0.640	16.26	0.063	1.60
1075	15	0.694	17.63	0.063	1.60
1079	19	0.749	19.02	0.065	1.65
1085	25	0.907	23.04	0.083	2.11

14 AWG (2.08 mm²)

Stranding (19 x 0.0147 (19 x 0.37 mm))
Insulation thickness: 0.047 (1.19 mm)

Part No.	Conductors	Nominal Diameter		Jacket Thickness	
		Inch	mm	Inch	mm
1274	4	0.503	12.78	0.047	1.19
1275	5	0.584	14.83	0.063	1.60
1277	7	0.635	16.13	0.063	1.60
1279	9	0.744	18.90	0.065	1.60
1282	12	0.867	22.02	0.083	2.11



Communication and Control

300 V Unshielded, Multiconductor, IRR PVC, PVC

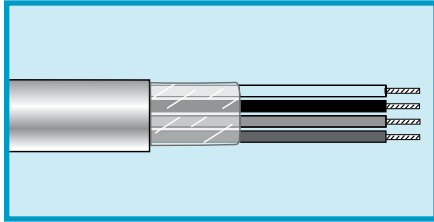

MIL-DTL-16878/1 (Type B)
UL AWM 2576 (150 V) VW-1

Operating Temperature

- -55°C to +105°C (MIL)
- -55°C to +80°C (AWM)

Conductor Color Coding

- 1 White, 2 Black, 3 Red, 4 Green

Materials

- Stranded tinned copper conductors
- Irradiated PVC insulation
- Clear polyester wrap
- White PVC jacket

Availability

100 ft (30.5 m)
 500 ft (152 m)
 1000 ft (305 m)

24 AWG (0.22 mm²)

Stranding: 7/32 (7 x 0.20 mm)
 Insulation thickness: 0.010 (0.25 mm)

Part No.	Conductors	Nominal Diameter		Jacket Thickness	
		Inch	mm	Inch	mm
6622	2	0.155	3.94	0.032	0.81
6623	3	0.162	4.11	0.032	0.81
6624	4	0.173	4.39	0.032	0.81

22 AWG (0.35 mm²)

Stranding: 7/30 (7 x 0.25 mm)
 Insulation thickness: 0.010 (0.25 mm)

Part No.	Conductors	Nominal Diameter		Jacket Thickness	
		Inch	mm	Inch	mm
6632	2	0.167	4.24	0.032	0.81
6633	3	0.175	4.44	0.032	0.81
6634	4	0.188	4.78	0.032	0.81

20 AWG (0.56 mm²)

Stranding: 7/28 (7 x 0.32 mm)
 Insulation thickness: 0.010 (0.25 mm)

Part No.	Conductors	Nominal Diameter		Jacket Thickness	
		Inch	mm	Inch	mm
6642	2	0.183	4.65	0.032	0.81
6643	3	0.192	4.88	0.032	0.81
6644	4	0.207	5.26	0.032	0.81

18 AWG (0.89 mm²)

Stranding: 7/26 (7 x 0.40 mm)
 Insulation thickness: 0.010 (0.25 mm)

Part No.	Conductors	Nominal Diameter		Jacket Thickness	
		Inch	mm	Inch	mm
6652	2	0.203	5.16	0.032	0.81
6653	3	0.214	5.44	0.032	0.81
6654	4	0.232	5.89	0.032	0.81

Communication and Control

300 V Unshielded and Braid Shield, Multiconductor, PVC, PVC

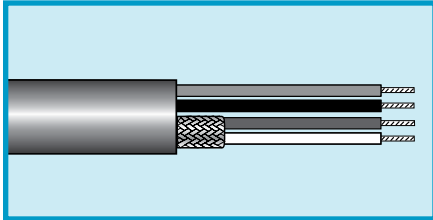

**UL AWM 2785 VW-1
UL CM
CSA CMG FT4**

Operating Temperature

- -20°C to +75°C (CM)
- -20°C to +60°C (AWM, CMG)

Conductor Color Coding

See tables

Materials

- Stranded tinned copper conductors
- PVC insulation
- Tinned copper braid shield, 80% coverage
- Slate PVC jacket

Availability

100 ft (30.5 m)*
500 ft (152 m)*
1000 ft (305 m)

*Parts 1243, 1243/4, and 1243/5 only

22 AWG Composite Shielded and Unshielded, UL AWM 2785, UL CM, and CSA CMG

22 AWG (0.35 mm²)

Stranding 7/30 (7 x 0.25 mm)
Insulation Thickness 0.016 (0.41 mm)

Part No.	Conductors	Nominal Diameter		Jacket Thickness		Configuration	
		Inch	mm	Inch	mm	Shielded	Unshielded
1243	3	0.190	4.83	0.020	0.51	1	2
1243/4	4	0.185 x 0.285	4.70 x 7.24	0.020	0.51	2	2
1243/5	5	0.195 x 0.300	4.95 x 7.62	0.020	0.51	3	2

Conductor Color Coding
Shielded: 1 White, 2 Black, 3 Red
Unshielded: 1 Black, 2 Red

22 and 18 AWG Unshielded, UL CM and CSA CMG Only

22 AWG (0.35 mm²)

Stranding: 7/30 (7 x 0.25 mm)
Insulation thickness: 0.010 (0.25 mm)

18 AWG (0.81 mm²)

16/30 (16 x 0.25 mm)
0.018 (0.45 mm)

Part No.	Conductors		Nominal Diameter		Jacket Thickness	
	22 AWG	18 AWG	Inch	mm	Inch	mm
1826C	4	2	0.241	6.12	0.025	0.63
1827C	5	2	0.247	6.27	0.028	0.71
1828C	6	2	0.261	6.63	0.028	0.71

Conductor Color Coding
22 AWG: Chart I (page 533)
18 AWG: Chart D (page 531)



Communication and Control

300 V Foil Shield, Multiconductor, PE, PVC

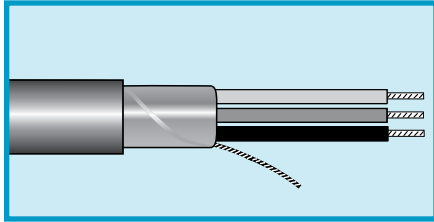

**UL AWM 2092, 2093,
2094 VW-1**
UL CMG
CSA CMG FT4

Operating Temperature

- -20°C to +75°C (CMG)
- -20°C to +60°C (AWM)

Conductor Color Coding

- 1 Black, 2 Red, 3 Natural, 4 Green

Materials

- Stranded tinned copper conductors
- Polyethylene insulation
- Aluminum/polyester foil shield, 25% overlap min.
Foil facing outward
- Stranded tinned copper drain wire (see table for sizes)
- Slate PVC jacket

Availability

100 ft (30.5 m)
500 ft (152 m), spool or box
1000 ft (305 m), spool or box

24 AWG (0.23 mm²)

Stranding: 7/32 (7 x 0.20 mm)
Insulation thickness: 0.016 (0.41 mm)
24 AWG (0.22 mm²) drain wire

Part No.	Conductors	Nominal Diameter		Jacket Thickness		AWM
		Inch	mm	Inch	mm	
2400C	2	0.156	3.96	0.020	0.51	2092

22 AWG (0.35 mm²)

Stranding: 7/30 (7 x 0.25 mm)
Insulation thickness: 0.016 (0.41 mm)
22 AWG (0.35 mm²) drain wire

Part No.	Conductors	Nominal Diameter		Jacket Thickness		AWM
		Inch	mm	Inch	mm	
2401C*	2	0.168	4.27	0.020	0.51	2092
2402C	2	0.168	4.27	0.020	0.51	2092
2403C	3	0.178	4.52	0.020	0.51	2093
2404C	4	0.194	4.93	0.020	0.51	2094

20 AWG (0.56 mm²)

Stranding: 7/28 (7 x 0.32 mm)
Insulation thickness: 0.016 (0.41 mm)
20 AWG (0.50 mm²) drain wire

Part No.	Conductors	Nominal Diameter		Jacket Thickness		AWM
		Inch	mm	Inch	mm	
2411C*	2	0.184	4.67	0.020	0.51	2092
2412C	2	0.184	4.67	0.020	0.51	2092
2413C	3	0.195	4.95	0.020	0.51	2093
2414C	4	0.213	5.41	0.020	0.51	2094

18 AWG (0.81 mm²)

Stranding: 16/30 (16 x 0.25 mm)
Insulation thickness: 0.016 (0.41 mm)
20 AWG (0.50 mm²) drain wire

Part No.	Conductors	Nominal Diameter		Jacket Thickness		AWM
		Inch	mm	Inch	mm	
2421C*	2	0.202	5.13	0.020	0.51	2092
2422C	2	0.202	5.13	0.020	0.51	2092
2423C	3	0.214	5.44	0.020	0.51	2093
2424C	4	0.235	5.97	0.020	0.51	2094

16 AWG (1.32 mm²)

Stranding: 19/0.117 (19 x 0.30 mm)
Insulation thickness: 0.016 (0.41 mm)
18 AWG (0.81 mm²) drain wire

Part No.	Conductors	Nominal Diameter		Jacket Thickness		AWM
		Inch	mm	Inch	mm	
2432C	2	0.226	5.74	0.020	0.51	2092
2433C	3	0.240	6.10	0.020	0.51	2093

*Color code: 1 black, 2 natural.



Communication and Control

300 V Foil Shield, Multiconductor, PE, PVC

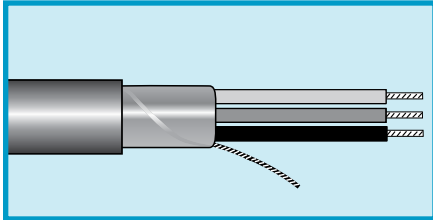

14 AWG (2.08 mm²)

Stranding: 41/30 (41 x 0.25 mm)
 Insulation thickness: 0.020 (0.51 mm)
 16 AWG (1.32 mm²) drain wire

Part No.	Conductors	Nominal Diameter		Jacket Thickness		UL
		Inch	mm	Inch	mm	
2442C	2	0.292	7.42	0.030	0.76	CL2

UL CL2
CSA AWM I/II A/B FT4

Operating Temperature

- -20°C to +75°C (CL2)
- -20°C to +60°C (AWM)

Conductor Color Coding

- 1 Black, 2 Red, 3 Natural, 4 Green

Materials

- Stranded tinned copper conductors
- Polyethylene insulation
- Aluminum/polyester foil shield, 25% overlap min.
 Foil facing outward
 Stranded tinned copper drain wire (see table for sizes)
- Slate PVC jacket

Availability

100 ft (30.5 m)
 500 ft (152 m), spool or box
 1000 ft (305 m), spool or box

12 AWG (3.29 mm²)

Stranding: 65/30 (65 x 0.25 mm)
 Insulation thickness: 0.020 (0.51 mm)
 14 AWG (2.08 mm²) drain wire

Part No.	Conductors	Nominal Diameter		Jacket Thickness		UL
		Inch	mm	Inch	mm	
2444C	2	0.330	8.38	0.030	0.76	CL2



Communication and Control

300 V Foil Shield, Multiconductor, PP, PE, PVC/PVC

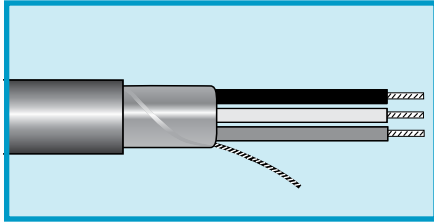

**UL CM
VW-1
CSA CMG FT4**

Operating Temperature

- -20°C to +75°C (CM)
- -20°C to +60°C (CMG)

Conductor Color Coding

- 1 White, 2 Black, 3 Red, 4 Green
- 1 Black, 2 Red, 3 White, 4 Green

Materials

- Stranded tinned copper conductors (except 2460C)
- PP, PE, or PVC insulation
- Aluminum/polyester foil shield, 25% overlap min.
Foil facing outward
1243/3C: foil facing inward
Stranded tinned copper drain wire (except 2460C)
- Slate PVC jacket
2461C: slate or black

Availability

100 ft (30.5 m)
500 ft (152 m)
1000 ft (305 m)

Polypropylene Insulation

22 AWG (0.35 mm²)

Stranding: 7/30 (7 x 0.25 mm) or solid
Insulation Thickness: 0.008 (0.20 mm)

Part No.	Conductors	Nominal Diameter		Jacket Thickness		Configuration	
		Inch	mm	Inch	mm	Shielded	Unshielded
2460C	2 (solid)	0.126	3.20	0.020	0.51	2	0
2461C	2	0.136	3.45	0.020	0.51	2	0

Polyethylene Insulation

20 AWG (0.56 mm²)

Stranding: 7/28 (7 x 0.32 mm)
Insulation Thickness: 0.014 (0.36 mm)

Part No.	Conductors	Nominal Diameter		Jacket Thickness		Configuration	
		Inch	mm	Inch	mm	Shielded	Unshielded
1243/3C	3	0.210	5.33	0.030	0.76	2	1
2464C	4	0.165	4.19	0.020	0.51	2	2

PVC Insulation

20 AWG (0.56 mm²)

Stranding: 7/28 (7 x 0.32 mm)
Insulation Thickness: 0.015 (0.38 mm)

Part No.	Conductors	Nominal Diameter		Jacket Thickness		Configuration	
		Inch	mm	Inch	mm	Shielded	Unshielded
2465C	4	0.240	6.10	0.030	0.76	2	2



Communication and Control

300 V Foil Shield, Multiconductor, PVC, PVC

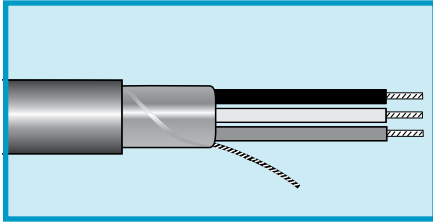

**UL AWM 2576 (150 V) VW-1
UL CM
CSA CMG FT4**

Operating Temperature

- -20°C to +80°C (AWM)
- -20°C to +75°C (CM)
- -20°C to +60°C (CMG)

Conductor Color Coding

- Chart D (page 531)

Materials

- Stranded tinned copper conductors
- PVC insulation
- Aluminum/polyester foil shield, 25% overlap min.
Foil facing outward
Stranded tinned copper drain wire equal in size to conductor
- Slate PVC jacket

Availability

100 ft (30.5 m)
500 ft (152 m)
1000 ft (305 m)

24 AWG (0.23 mm²)

Stranding: 7/32 (7 x 0.20 mm)
Insulation thickness: 0.010 (0.25 mm)

Part No.	Conductors	Nominal Diameter		Jacket Thickness	
		Inch	mm	Inch	mm
1212C	2	0.156	3.96	0.032	0.81
1213C	3	0.163	4.14	0.032	0.81
1214C	4	0.174	4.42	0.032	0.81
1215C	5	0.187	4.75	0.032	0.81
1216C	6	0.201	5.11	0.032	0.81
1217C	7	0.201	5.11	0.032	0.81
1218C	8	0.214	5.44	0.032	0.81
1219C	9	0.228	5.79	0.032	0.81
1219/10C	10	0.244	6.20	0.032	0.81
1219/12C	12	0.251	6.38	0.032	0.81
1219/15C	15	0.270	6.86	0.032	0.81
1219/20C	20	0.298	7.57	0.032	0.81
1219/25C	25	0.332	8.43	0.032	0.81
1219/37C	37	0.376	9.55	0.032	0.81
1219/40C	40	0.390	9.91	0.032	0.81
1219/50C	50	0.427	10.85	0.032	0.81

22 AWG (0.35 mm²)

Stranding: 7/30 (7 x 0.25 mm)
Insulation thickness: 0.010 (0.25 mm)

Part No.	Conductors	Nominal Diameter		Jacket Thickness	
		Inch	mm	Inch	mm
1292C	2	0.168	4.27	0.032	0.81
1293C	3	0.176	4.47	0.032	0.81
1294C	4	0.189	4.80	0.032	0.81
1295C	5	0.204	5.18	0.032	0.81
1296C	6	0.219	5.56	0.032	0.81
1297C	7	0.219	5.56	0.032	0.81
1298C	8	0.234	5.94	0.032	0.81
1299C	9	0.250	6.35	0.032	0.81
1299/10C	10	0.268	6.81	0.032	0.81
1299/12C	12	0.276	7.01	0.032	0.81
1299/15C	15	0.298	7.57	0.032	0.81
1299/20C	20	0.330	8.38	0.032	0.81
1299/25C	25	0.368	9.35	0.032	0.81
1299/30C	30	0.389	9.88	0.032	0.81
1299/37C	37	0.418	10.62	0.032	0.81
1299/40C	40	0.433	11.00	0.032	0.81
1299/50C	50	0.482	12.24	0.035	0.89



Communication and Control

300 V Foil Shield, Multiconductor, SR-PVC, PVC

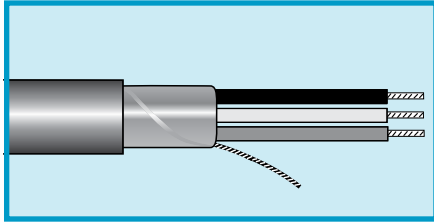

UL AWM 2464 VW-1
UL CM
CSA CMG FT4

Operating Temperature

- -20°C to +80°C (AWM)
- -20°C to +75°C (CM)
- -20°C to +60°C (CMG)

Conductor Color Coding

- Chart F (page 532)

Materials

- Stranded tinned copper conductors
- Semirigid PVC insulation
- Aluminum/polyester foil shield, 25% overlap min.
Foil facing outward
- Stranded tinned copper drain wire equal in size to conductor
- Slate PVC jacket

Availability

100 ft (30.5 m)
 500 ft (152 m)
 1000 ft (305 m)

24 AWG (0.22 mm²)

Stranding: 7/32 (7 x 0.20 mm)
 Insulation thickness: 0.010 (0.25 mm)

Part No.	Conductors	Nominal Diameter		Jacket Thickness	
		Inch	mm	Inch	mm
6300/3*	3	0.163	4.14	0.032	0.81
6300/4*	4	0.174	5.44	0.032	0.81
6305	5	0.187	4.75	0.032	0.81
6306*	6	0.201	5.11	0.032	0.81
6300/8*	8	0.214	5.44	0.032	0.81
6300/10*	10	0.244	6.20	0.032	0.81
6307	15	0.270	6.86	0.032	0.81
6308	20	0.298	7.57	0.032	0.81
6309	25	0.332	8.43	0.032	0.81
6310	30	0.366	9.30	0.040	1.02
6311	40	0.406	10.31	0.040	1.02
6312	50	0.453	11.51	0.045	1.14

Mutual capacitance: 32 pF/ft (105 pF/m)
 Ground capacitance: 58 pF/ft (190 pF/m)

*Color coding: 1 Black, 2 White, 3 Red, 4 Green, 5 Brown, 6 Blue, 7 Orange, 8 Yellow, 9 Violet, 10 Slate.



Communication and Control

300 V Spiral Shield, Multiconductor, PVC, PVC

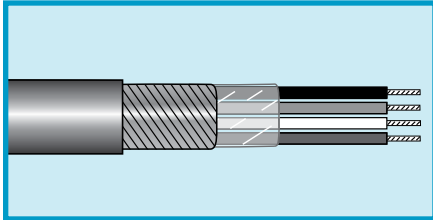

AWM 2095
AWM 1108 (Single-conductor cables)

Operating Temperature

- -20°C to +80°C

Conductor Color Coding

- 1 Black, 2 Red, 3 White, 4 Green, 5 Yellow, 6 Blue

Materials

- Stranded tinned copper conductors
- PVC insulation
- Clear polyester wrap (multiconductor only)
- Bare copper spiral shield, 95% coverage
- Slate PVC jacket

Availability

100 ft (30.5 m)
 500 ft (152 m)
 1000 ft (305 m)

22 AWG (0.35 mm²)

Stranding: 7/30 (7 x 0.25 mm)
 Insulation thickness: 0.016 (0.41 mm)

Part No.	Conductors	Nominal Diameter		Jacket Thickness	
		Inch	mm	Inch	mm
2254/1	1	0.112	2.84	0.020	0.51
2254	2	0.177	4.50	0.020	0.51
2254/3	3	0.187	4.75	0.020	0.51
2254/4	4	0.206	5.23	0.020	0.51
2254/6	6	0.243	6.17	0.020	0.51

20 AWG (0.56 mm²)

Stranding: 10/30 (10 x 0.25 mm)
 Insulation thickness: 0.016 (0.41 mm)

Part No.	Conductors	Nominal Diameter		Jacket Thickness	
		Inch	mm	Inch	mm
2256/1	1	0.119	3.02	0.020	0.51
2256	2	0.191	4.85	0.020	0.51
2256/3	3	0.202	5.13	0.020	0.51
2256/4	4	0.223	5.66	0.020	0.51
2256/6	6	0.264	6.71	0.020	0.51

18 AWG (0.81 mm²)

Stranding: 16/30 (16 x 0.25 mm)
 Insulation thickness: 0.016 (0.41 mm)

Part No.	Conductors	Nominal Diameter		Jacket Thickness	
		Inch	mm	Inch	mm
2258/1	1	0.129	3.28	0.020	0.51
2258	2	0.214	5.44	0.020	0.51
2258/3	3	0.226	5.74	0.020	0.51
2258/4	4	0.247	6.27	0.020	0.51

16 AWG (1.32 mm²)

Stranding: 26/30 (26 x 0.25 mm)
 Insulation thickness: 0.016 (0.41 mm)

Part No.	Conductors	Nominal Diameter		Jacket Thickness	
		Inch	mm	Inch	mm
2260	2	0.240	6.10	0.020	0.51
2260/3	3	0.254	6.45	0.020	0.51



Communication and Control

600 V Braid Shield, Multiconductor, PVC, PVC

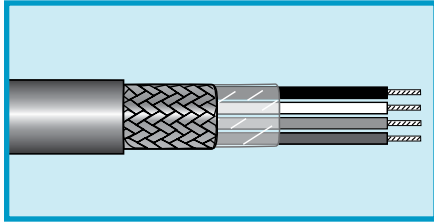

MIL-DTL-16878/1 (Type B)

Operating Temperature

- -55°C to +105°C

Conductor Color Coding

- Chart F (page 532)

Materials

- Stranded tinned copper conductors
- PVC insulation
- Clear polyester wrap
- Tinned copper braid shield, 90% coverage
- Slate PVC jacket

Availability

- 100 ft (30.5 m)
- 1000 ft (305 m)

28 AWG (0.09 mm²)

Stranding: 7/36 (7 x 0.13 mm)
Insulation thickness: 0.010 (0.25 mm)

Part No.	Conductors	Nominal Diameter		Jacket Thickness	
		Inch	mm	Inch	mm
3302	2	0.119	3.02	0.012	0.30
3303	3	0.124	3.15	0.012	0.30
3304	4	0.134	3.40	0.012	0.30
3306	6	0.161	4.09	0.015	0.38
3308	8	0.171	4.34	0.015	0.38
3310	10	0.201	5.11	0.018	0.46
3312	12	0.206	5.23	0.018	0.46
3315	15	0.236	5.99	0.020	0.51
3320	20	0.261	6.63	0.022	0.56

Communication and Control

600 V Braid Shield, Multiconductor, PVC/Nylon, PVC

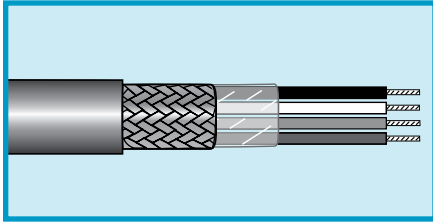

MIL-DTL-16878/17 (Type B/N)

Operating Temperature

- 55°C to +105°C

Conductor Color Coding

- 1 White, 2 Black, 3 Red, 4 Green (unless otherwise noted)

Materials

- Stranded tinned copper conductors
- PVC/nylon insulation
- Clear polyester wrap (multiconductor only)
- Tinned copper braid shield, 90% coverage
- Slate PVC jacket

Availability

- 100 ft (30.5 m)
- 500 ft (152 m)
- 1000 ft (305 m)

26 AWG (0.14 mm²)

Stranding: 7/34 (7 x 0.16 mm)
Insulation thickness: 0.010 (0.25 mm) PVC/0.003 (0.08 mm) nylon

Part No.	Conductors	Nominal Diameter		Jacket Thickness	
		Inch	mm	Inch	mm
3200	1	0.087	2.21	0.010	0.25
3201	2	0.143	3.63	0.014	0.36
3202	3	0.150	3.81	0.014	0.36
3203	4	0.166	4.22	0.016	0.41

24 AWG (0.24 mm²)

Stranding: 19/36 (19 x 0.13 mm)
Insulation thickness: 0.010 (0.25 mm) PVC/0.003 (0.08 mm) nylon

Part No.	Conductors	Nominal Diameter		Jacket Thickness	
		Inch	mm	Inch	mm
3210	1	0.093	2.36	0.010	0.25
3211	2	0.159	4.04	0.016	0.41
3212	3	0.167	4.24	0.016	0.41
3213	4	0.182	4.62	0.017	0.43

22 AWG (0.38 mm²)

Stranding: 19/34 (19 x 0.16 mm)
Insulation thickness: 0.010 (0.25 mm) PVC/0.003 (0.08 mm) nylon

Part No.	Conductors	Nominal Diameter		Jacket Thickness	
		Inch	mm	Inch	mm
3220	1	0.100	2.54	0.010	0.25
3221	2	0.173	4.39	0.016	0.41
3222	3	0.184	4.67	0.017	0.43
3223	4	0.203	5.16	0.019	0.49
3335*	5	0.228	5.79	0.020	0.51
3336*	6	0.246	6.25	0.020	0.64
3337*	8	0.274	6.96	0.025	0.64

*Color code chart F.

Communication and Control

600 V Braid Shield, Multipair, PVC/Nylon, PVC

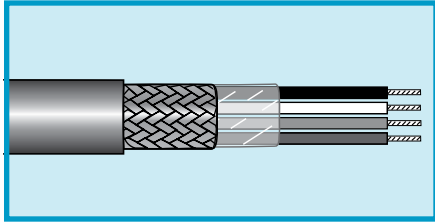

MIL-DTL-16878/17 (Type B/N)

Operating Temperature

- 55°C to +105°C

Conductor Color Coding

- 1 White, 2 Black, 3 Red, 4 Green (unless otherwise noted)

Materials

- Stranded tinned copper conductors
- PVC/nylon insulation
- Clear polyester wrap (multiconductor only)
- Tinned copper braid shield, 90% coverage
- Slate PVC jacket

Availability

- 100 ft (30.5 m)
- 500 ft (152 m)
- 1000 ft (305 m)

20 AWG (0.61 mm²)

Stranding: 19/32 (19 x 0.20 mm)
Insulation thickness: 0.010 (0.25 mm) PVC/0.003 (0.08 mm) nylon

Part No.	Conductors	Nominal Diameter		Jacket Thickness	
		Inch	mm	Inch	mm
3230	1	0.108	2.74	0.010	0.25
3231	2	0.195	4.95	0.019	0.49
3232	3	0.205	5.21	0.019	0.49
3233	4	0.227	5.77	0.021	0.53

18 AWG (0.96 mm²)

Stranding: 19/30 (19 x 0.25 mm)
Insulation thickness: 0.010 (0.25 mm) PVC/0.003 (0.08 mm) nylon

Part No.	Conductors	Nominal Diameter		Jacket Thickness	
		Inch	mm	Inch	mm
3240	1	0.122	3.10	0.012	0.30
3241	2	0.219	5.56	0.021	0.53
3242	3	0.233	5.92	0.022	0.56
3243	4	0.261	6.63	0.023	0.58

16 AWG (1.23 mm²)

Stranding: 19/29 (19 x 0.29 mm)
Insulation thickness: 0.010 (0.25 mm) PVC/0.003 (0.08 mm) nylon

Part No.	Conductors	Nominal Diameter		Jacket Thickness	
		Inch	mm	Inch	mm
3245	1	0.136	0.136	0.016	0.41
3246	2	0.241	0.241	0.023	0.58
3247	3	0.254	0.254	0.023	0.58
3248	4	0.279	0.279	0.025	0.64

Communication and Control

300 V Braid Shield, Multiconductor, PVC, PVC

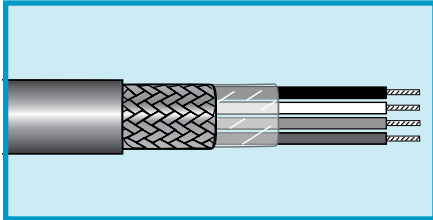

UL AWM 2095 VW-1
UL AWM 1108
(Single-Conductor Cables)
UL CM
CSA CMG FT4

Operating Temperature

- -20°C to +80°C (AWM)
- -20°C to +75°C (CM)
- -20°C to +60°C (CMG)

Conductor Color Coding

- Chart D (page 531)

Materials

- Stranded or solid tinned copper conductors
- PVC insulation
- Clear polyester wrap (multiconductor only)
- Bare copper braid shield, 75% coverage
- Slate PVC jacket

Availability

100 ft (30.5 m)
 500 ft (152 m)
 1000 ft (305 m)

22 AWG (0.32 mm²)

Stranding: Solid
 Insulation thickness: 0.020 (0.51 mm)

Part No.	Conductors	Nominal Diameter		Jacket Thickness	
		Inch	mm	Inch	mm
1775C	2	0.195	4.95	0.020	0.51

22 AWG (0.35 mm²)

Stranding: 7/30 (7 x 0.25 mm)
 Insulation thickness: 0.016 (0.41 mm)

Part No.	Conductors	Nominal Diameter		Jacket Thickness	
		Inch	mm	Inch	mm
1735	1	0.124	3.15	0.020	0.51
1736C	2	0.189	4.80	0.020	0.51
1737C	3	0.199	5.05	0.020	0.51
1738C	4	0.215	5.46	0.020	0.51

20 AWG (0.56 mm²)

Stranding: 7/28 (7 x 0.32 mm)
 Insulation thickness: 0.016 (0.41 mm)

Part No.	Conductors	Nominal Diameter		Jacket Thickness	
		Inch	mm	Inch	mm
1741C	2	0.205	5.21	0.020	0.51
1742C	3	0.216	5.49	0.020	0.51
1743C	4	0.234	5.94	0.020	0.51

18 AWG (0.81 mm²)

Stranding: 16/30 (16 x 0.25 mm)
 Insulation thickness: 0.016 (0.41 mm)

Part No.	Conductors	Nominal Diameter		Jacket Thickness	
		Inch	mm	Inch	mm
1745	1	0.141	3.58	0.020	0.51
1746C	2	0.223	5.66	0.020	0.51
1747C	3	0.235	5.97	0.020	0.51
1747/4C	4	0.256	6.50	0.020	0.51

16 AWG (1.32 mm²)

Stranding: 19/0.0117 (19 x 0.30 mm)
 Insulation thickness: 0.016 (0.41 mm)

Part No.	Conductors	Nominal Diameter		Jacket Thickness	
		Inch	mm	Inch	mm
1748C	2	0.247	6.27	0.020	0.51
1749C	3	0.261	6.63	0.020	0.51



Communication and Control

450 V Braid Shield, Multiconductor, PVC, PVC

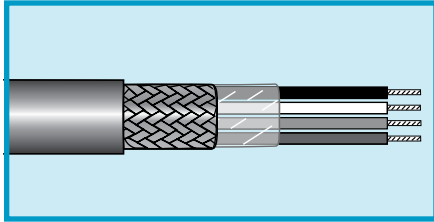

Operating Temperature

- -20°C to +80°C

Conductor Color Coding

- Chart D (page 531)

Materials

- Stranded tinned copper conductors
- PVC insulation
- Clear polyester wrap
- Bare copper braid shield, 75% coverage
- Slate PVC jacket

Availability

- 100 ft (30.5 m)
- 500 ft (152 m)
- 1000 ft (305 m)

14 AWG (2.08 mm²)

Stranding: 41/30 (41 x 0.25 mm)
Insulation thickness: 0.020 (0.51 mm)

Part No.	Conductors	Nominal Diameter		Jacket Thickness	
		Inch	mm	Inch	mm
1750	2	0.299	7.59	0.020	0.51
1751	3	0.317	8.05	0.020	0.51

12 AWG (3.29 mm²)

Stranding: 65/30 (65 x 0.25 mm)
Insulation thickness: 0.020 (0.51 mm)

Part No.	Conductors	Nominal Diameter		Jacket Thickness	
		Inch	mm	Inch	mm
1760	2	0.337	8.56	0.020	0.51
1761	3	0.358	9.09	0.020	0.51

Communication and Control

600 V Braid Shield, Multiconductor, IRR PVC, PVC

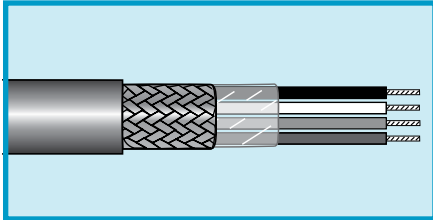

MIL-DTL-16878/1 (Type B)

Operating Temperature

- 55°C to +105°C

Conductor Color Coding

- Chart G (page 532)

Materials

- Stranded tinned copper conductors
- Irradiated PVC insulation
- Clear polyester wrap
- Tinned copper braid shield, 90% coverage
- White PVC jacket

Availability

1000 ft (305 m)

24 AWG (0.22 mm²)

Stranding: 7/32 (7 x 0.20 mm)
Insulation thickness: 0.010 (0.25 mm)

Part No.	Conductors	Nominal Diameter		Jacket Thickness	
		Inch	mm	Inch	mm
7622	2	0.163	4.14	0.025	0.64
7623	3	0.170	4.32	0.025	0.64
7624	4	0.181	4.60	0.025	0.64

22 AWG (0.35 mm²)

Stranding: 7/30 (7 x 0.25 mm)
Insulation thickness: 0.010 (0.25 mm)

Part No.	Conductors	Nominal Diameter		Jacket Thickness	
		Inch	mm	Inch	mm
7631	1	0.122	3.10	0.025	0.64
7632	2	0.175	4.45	0.025	0.64
7633	3	0.183	4.65	0.025	0.64
7634	4	0.196	4.98	0.025	0.64

20 AWG (0.56 mm²)

Stranding: 7/28 (7 x 0.32 mm)
Insulation thickness: 0.010 (0.25 mm)

Part No.	Conductors	Nominal Diameter		Jacket Thickness	
		Inch	mm	Inch	mm
7661	1	0.130	3.30	0.025	0.64
7662	2	0.191	4.85	0.025	0.64
7663	3	0.200	5.08	0.025	0.64
7664	4	0.215	5.46	0.025	0.64

18 AWG (0.89 mm²)

Stranding: 7/26 (7 x 0.40 mm)
Insulation thickness: 0.010 (0.25 mm)

Part No.	Conductors	Nominal Diameter		Jacket Thickness	
		Inch	mm	Inch	mm
7671	1	0.140	3.56	0.025	0.64
7672	2	0.211	5.35	0.025	0.64
7673	3	0.222	5.64	0.025	0.64
7674	4	0.240	6.09	0.025	0.64

Communication and Control

1000 V Braid Shield, Multiconductor, PVC, PVC

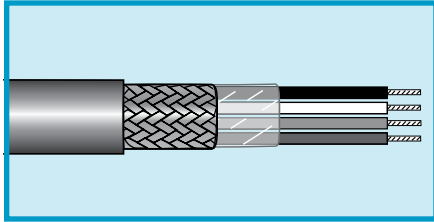

MIL-DTL-16878/2 (Type C)

Operating Temperature

- 55°C to +105°C

Conductor Color Coding

- Chart F (page 532)

Materials

- Stranded tinned copper conductors
- PVC insulation
- Clear polyester wrap
- Tinned copper braid shield, 90% coverage
- Slate PVC jacket

Availability

- 100 ft (30.5 m)
- 1000 ft (305 m)

18 AWG (0.96 mm²)

Stranding: 19/30 (19 x 0.25 mm)
Insulation thickness: 0.016 (0.41 mm)

Part No.	Conductors	Nominal Diameter		Jacket Thickness	
		Inch	mm	Inch	mm
3405	5	0.303	7.70	0.025	0.64
3408	8	0.364	9.25	0.030	0.76
3410	10	0.429	10.90	0.035	0.89
3412	12	0.442	11.23	0.035	0.89
3415	15	0.488	12.40	0.040	1.02
3420	20	0.550	13.97	0.045	1.14
3430	30	0.667	16.94	0.055	1.40

16 AWG (1.23 mm²)

Stranding: 19/29 (19 x 0.29 mm)
Insulation thickness: 0.018 (0.45 mm)

Part No.	Conductors	Nominal Diameter		Jacket Thickness	
		Inch	mm	Inch	mm
3444	4	0.316	8.03	0.031	0.79
3446	6	0.376	9.55	0.034	0.86
3450	10	0.487	12.37	0.044	1.12
3452	12	0.509	12.93	0.048	1.22

Communication and Control

Braid or Spiral Shield, Multiconductor, PE, PVC Microphone Cable

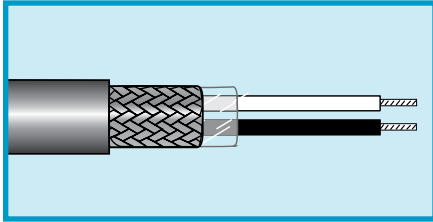

Operating Temperature

- 20°C to +60°C

Conductor Color Coding

- 1-White, 2-Black

Materials

- Stranded tinned copper conductors
- Polyethylene insulation
- Clear polyester wrap (multiconductor only)

- Braided tinned copper or spiral wrapped tinned copper shield, 90% coverage (85% for part no. 1712)
- Slate PVC jacket

Availability

- 100 ft (30.5 m)
- 500 ft (152 m)
- 1000 ft (305 m)

1-Conductor Cable for High-Impedance Microphones

Part No.	Voltage Rating	Wire Size		Stranding		Nominal Diameter		Shield	Jacket Thickness		Insulation Thickness		Capacitance	
		AWG	mm ²	AWG	mm	Inch	mm		Inch	mm	Inch	mm	pF/ft	pF/m
1706*	4000	20	0.52	26/34	26 x 0.16	0.182	4.62	Braid	0.030	0.76	0.031	0.79	38	125
1703	3500	24	0.20	10/34	10 x 0.16	0.146	3.71	Braid	0.030	0.76	0.020	0.50	36	118
1702**	1000	26	0.14	7/34	7 x 0.16	0.101	2.57	Spiral	0.020	0.51	0.016	0.41	35	115
1705	1000	24	0.20	10/34	10 x 0.16	0.106	2.69	Spiral	0.020	0.51	0.016	0.41	41	135

*UL AWM 1150, 300 V.

**1702 has 3 strands of tinned copper and 4 strands of tinned Copperweld.

2-Conductor Cable for Low-Impedance Microphones

Part No.	Voltage Rating	Wire Size		Stranding		Nominal Diameter		Shield	Jacket Thickness		Insulation Thickness		Capacitance*	
		AWG	mm ²	AWG	mm	Inch	mm		Inch	mm	Inch	mm	pF/ft	pF/m
1709	1000	24	0.20	10/34	10 x 0.16	0.185	4.70	Spiral	0.030	0.76	0.016	0.41	32	105
1710	1000	22	0.38	19/34	19 x 0.16	0.239	6.07	Braid	0.025	0.64	0.025	0.63	30	98
1712	600	20	0.52	26/34	26 x 0.16	0.221	5.61	Braid	0.030	0.76	0.015	0.38	44	144

*Capacitance between one conductor and remaining conductors connected to shield.

Communication and Control

600 V Braid Shield, Multiconductor, PE, PVC Audio Cable

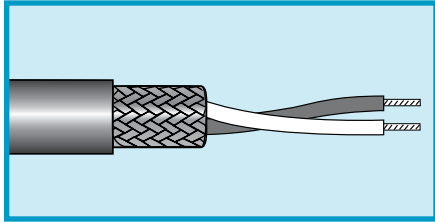

Materials

- Bare copper conductors
- Polyethylene insulation
- Tinned copper braid shield, 95% coverage
- PVC jacket

Operating Temperature

- -20°C to +60°C

Availability

- 100 ft (30.5 m)
- 1000 ft (305 m)

Conductor Color Coding

- 1771: White, blue
Black, red, or orange jacket
- 1772: White, blue, white, blue
Black, brown, slate, or yellow jacket

Part No.	Conductors	Wire Size		Stranding		Nominal Diameter		Shield	Jacket Thickness		Insulation Thickness		Capacitance	
		AWG	mm ²	AWG	mm	Inch	mm		Inch	mm	Inch	mm	pF/ft	pF/m
1771	2	23	0.29	60/40	60 x 0.08	0.243	6.17	Braid	0.040	1.01	0.020	0.51	17.9	58.7
1772	4	25	0.20	40/40	40 x 0.08	0.239	6.07	Braid	0.044	1.11	0.014	0.35	18	69.1

Communication and Control

600 V Multiconductor, PE, PVC
Braid Shield

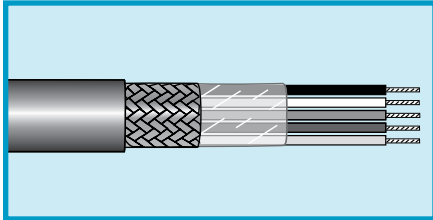

Operating Temperature

- -20°C to +60°C

Conductor Color Coding

- Chart H (page 533)

Materials

- Stranded tinned copper conductors
- Polyethylene insulation
- Clear polyester wrap
- Braided tinned copper shield, 85% coverage
- Slate PVC jacket

Availability

100 ft (30.5 m)
500 ft (152 m)
1000 ft (305 m)

20 AWG (0.52 mm²)

Stranding: 26/34 (26 x 0.16 mm)
Insulation thickness: 0.015 (0.38 mm)

Part No.	Conductors	Nominal Diameter		Jacket Thickness	
		Inch	mm	Inch	mm
1712	2	0.221	5.61	0.030	0.76
1713	3	0.248	6.30	0.035	0.88
1715	4	0.266	6.76	0.035	0.88
1716	5	0.285	7.24	0.035	0.88
1717	6	0.306	7.77	0.035	0.88
1719	8	0.327	8.31	0.035	0.88
1721	10	0.373	9.47	0.035	0.88
1723	12	0.384	9.75	0.035	0.88
1726	15	0.421	10.69	0.035	0.88
1728	20	0.462	11.73	0.035	0.88

Communication and Control

600 V Multiconductor, Rubber, Polychloroprene Braid Shield

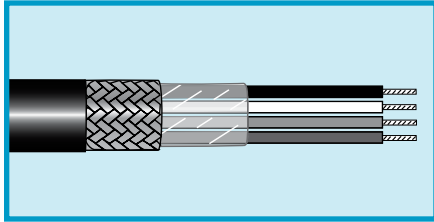

Operating Temperature

- -20°C to +60°C

Conductor Color Coding

- Chart H (page 533)

Materials

- Stranded tinned copper conductors
- EPDM rubber insulation
- Clear polyester wrap
- Tinned copper braid shield, 85% coverage
- Black polychloroprene jacket

Availability

- 100 ft (30.5 m)
- 500 ft (152 m)
- 1000 ft (305 m)

18 AWG (0.82 mm²)

Stranding: 41/34 (41 x 0.16 mm)
Insulation thickness: 0.020 (0.51 mm)

Part No.	Conductors	Nominal Diameter		Jacket Thickness	
		Inch	mm	Inch	mm
1450	2	0.298	7.57	0.045	1.14
1454	6	0.392	9.96	0.045	1.14

16AWG (1.31 mm²)

Stranding: 65/34 (65 x 0.16 mm)
Insulation thickness: 0.026 (0.65 mm)

Part No.	Conductors	Nominal Diameter		Jacket Thickness	
		Inch	mm	Inch	mm
1450/16	2	0.327	8.31	0.036	0.91
1451/16	3	0.350	8.89	0.037	0.94

Communication and Control

600 V Multiconductor, PTFE, FEP
Braid Shield

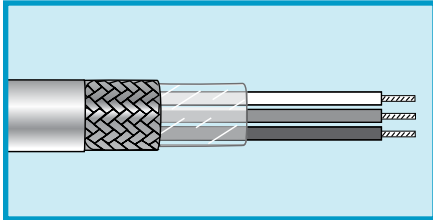

MIL-DTL-16878/4 (Type E) NEMA HP3-EXBEE

Operating Temperature

- 55°C to +200°C

Conductor Color Coding

- Chart G (page 532)

Materials

- Stranded silver-plated copper conductors
- PTFE insulation
- Clear polyester wrap
- Silver-plated copper braid shield, 90% coverage
- White FEP jacket

Availability

100 ft (30.5 m)

1000 ft (305 m)*

*May contain multiple lengths

24 AWG (0.24 mm²)

Stranding: 19/36 (19 x 0.13 mm)
Insulation thickness: 0.010 (0.25 mm)

Part No.	Conductors	Nominal Diameter		Jacket Thickness	
		Inch	mm	Inch	mm
2831	1	0.087	2.21	0.010	0.25
2831/2	2	0.132	3.35	0.010	0.25
2831/3	3	0.139	3.53	0.010	0.25

22 AWG (0.38 mm²)

Stranding: 19/34 (19 x 0.16 mm)
Insulation thickness: 0.009 (0.23 mm)

Part No.	Conductors	Nominal Diameter		Jacket Thickness	
		Inch	mm	Inch	mm
2834	1	0.092	2.34	0.010	0.25
2834/2	2	0.142	3.61	0.010	0.25
2834/3	3	0.154	3.91	0.012	0.30

20 AWG (0.62 mm²)

Stranding: 19/32 (19 x 0.20 mm)
Insulation thickness: 0.009 (0.23 mm)

Part No.	Conductors	Nominal Diameter		Jacket Thickness	
		Inch	mm	Inch	mm
2837/2	2	0.162	4.11	0.012	0.30
2837/3	3	0.171	4.34	0.012	0.30

Communication and Control

600 V Multiconductor, TFE, Fiberglass Braid Shield

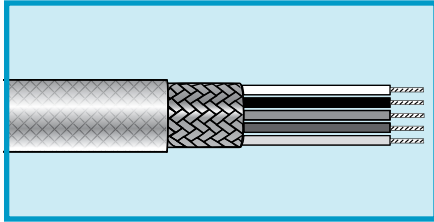

MIL-DTL-16878/4 (Type E) NEMA HP3-EXBEE

Operating Temperature

- 55°C to +200°C

Conductor Color Coding

- Chart G (page 532)

Materials

- Stranded silver-plated copper conductors
- TFE insulation
- Silver-plated copper braid shield, 90% coverage
- White PTFE-impregnated fiberglass jacket

Availability

100 ft (30.5 m)

1000 ft (305 m)*

*May contain multiple lengths

24 AWG (0.24 mm²)

Stranding: 19/36 (19 x 0.13 mm)
Insulation thickness: 0.010 (0.25 mm)

Part No.	Conductors	Nominal Diameter		Jacket Thickness	
		Inch	mm	Inch	mm
2811	1	0.100	2.54	0.012	0.30
2811/2	2	0.145	3.68	0.012	0.30
2811/3	3	0.152	3.86	0.012	0.30
2811/4	4	0.164	4.17	0.012	0.30
2811/5	5	0.177	4.50	0.012	0.30
2811/7	7	0.191	4.85	0.012	0.30

22 AWG (0.38 mm²)

Stranding: 19/34 (19 x 0.16 mm)
Insulation thickness: 0.009 (0.23 mm)

Part No.	Conductors	Nominal Diameter		Jacket Thickness	
		Inch	mm	Inch	mm
2814/2	2	0.155	3.94	0.012	0.30
2814/4	4	0.176	4.47	0.012	0.30
2814/6	6	0.206	5.23	0.012	0.30

20 AWG (0.62 mm²)

Stranding: 19/32 (19 x 0.20 mm)
Insulation thickness: 0.009 (0.23 mm)

Part No.	Conductors	Nominal Diameter		Jacket Thickness	
		Inch	mm	Inch	mm
2817/2	2	0.171	4.34	0.012	0.30
2817/3	3	0.180	4.57	0.012	0.30
2817/4	4	0.195	4.95	0.012	0.30
2817/5	5	0.212	5.38	0.012	0.30
2817/6	6	0.230	5.84	0.012	0.30

Communication and Control

600 V Multiconductor, TFE, Fiberglass Braid Shield

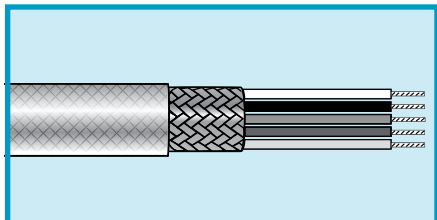

MIL-DTL-16878/4 (Type E) NEMA HP3

Operating Temperature

- 55°C to +200°C

Conductor Color Coding

- Chart G (page 532)

Materials

- Stranded silver-plated copper conductors
- TFE insulation
- Silver-plated copper braid shield, 90% coverage
- White PTFE-impregnated fiberglass jacket

Availability

100 ft (30.5 m)

1000 ft (305 m)*

*May contain multiple lengths

18 AWG (0.96 mm²)

Stranding: 19/30 (19 x 0.25 mm)
Insulation thickness: 0.010 (0.25 mm)

Part No.	Conductors	Nominal Diameter		Jacket Thickness	
		Inch	mm	Inch	mm
2819	1	0.125	3.18	0.012	0.30
2819/2	2	0.195	4.95	0.012	0.30
2819/3	3	0.206	5.23	0.012	0.30
2819/4	4	0.224	5.69	0.012	0.30
2819/5	5	0.245	6.22	0.012	0.30

16 AWG (1.32 mm²)

Stranding: 19/29 (19 x 0.29 mm)
Insulation thickness: 0.012 (0.30 mm)

Part No.	Conductors	Nominal Diameter		Jacket Thickness	
		Inch	mm	Inch	mm
2820	1	0.135	3.43	0.012	0.30
2820/2	2	0.215	5.46	0.012	0.30
2820/3	3	0.228	5.79	0.012	0.30
2820/4	4	0.249	6.32	0.012	0.30

14 AWG (1.23 mm²)

Stranding: 19/27 (19 x 0.36 mm)
Insulation thickness: 0.012 (0.30 mm)

Part No.	Conductors	Nominal Diameter		Jacket Thickness	
		Inch	mm	Inch	mm
2804/2	1	0.245	6.22	0.012	0.30
2804/3	2	0.260	6.60	0.012	0.30

12 AWG (3.08 mm²)

Stranding: 19/25 (19 x 0.46 mm)
Insulation thickness: 0.012 (0.30 mm)

Part No.	Conductors	Nominal Diameter		Jacket Thickness	
		Inch	mm	Inch	mm
2803/2	2	0.283	7.19	0.012	0.30

Communication and Control

600 V Multiconductor, PTFE, PTFE Tape Braid Shield

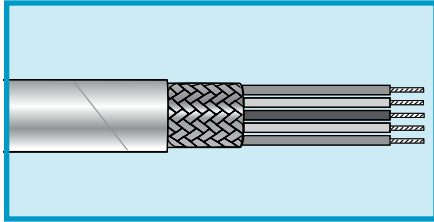

MIL-DTL-16878/4 (Type E)
NEMA HP3-EXBEE

Operating Temperature

- -55°C to +200°C

Conductor Color Coding

- Chart G (page 532)

Materials

- Stranded silver-plated copper conductors
- PTFE insulation
- Silver-plated copper braid shield, 90% coverage
- White PTFE tape jacket

Availability

100 ft (30.5 m)

1000 ft (305 m)*

*May contain multiple lengths

24 AWG (0.24 mm²)

Stranding: 19/36 (19 x 0.13 mm)
Insulation thickness: 0.010 (0.25 mm)

Part No.	Conductors	Nominal Diameter		Jacket Thickness	
		Inch	mm	Inch	mm
2821	1	0.087	2.21	0.010	0.25
2821/2	2	0.136	3.45	0.012	0.30
2821/3	3	0.143	3.63	0.012	0.30
2821/4	4	0.155	3.94	0.012	0.30
2821/5	5	0.168	4.27	0.012	0.30
2821/6	6	0.182	4.62	0.012	0.30

22 AWG (0.38 mm²)

Stranding: 19/34 (19 x 0.16 mm)
Insulation thickness: 0.009 (0.23 mm)

Part No.	Conductors	Nominal Diameter		Jacket Thickness	
		Inch	mm	Inch	mm
2824	1	0.092	2.34	0.010	0.25
2824/2	2	0.146	3.71	0.012	0.30
2824/3	3	0.154	3.91	0.012	0.30
2824/4	4	0.167	4.24	0.012	0.30
2824/5	5	0.182	4.62	0.012	0.30
2824/6	6	0.193	4.90	0.012	0.30

20 AWG (0.62 mm²)

Stranding: 19/32 (19 x 0.20 mm)
Insulation thickness: 0.009 (0.23 mm)

Part No.	Conductors	Nominal Diameter		Jacket Thickness	
		Inch	mm	Inch	mm
2827	1	0.100	2.54	0.010	0.25
2827/2	2	0.158	4.01	0.012	0.30
2827/3	3	0.171	4.34	0.012	0.30
2827/4	4	0.186	4.72	0.012	0.30
2827/5	5	0.203	5.16	0.012	0.30
2827/6	6	0.221	5.61	0.012	0.30

Communication and Control

600 V Multiconductor, PTFE, PTFE Tape
Braid Shield

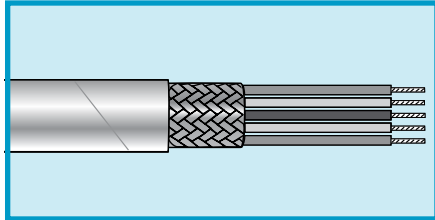

MIL-DTL-16878/4 (Type E)
NEMA HP3-EXBEE

Operating Temperature

- -55°C to +200°C

Conductor Color Coding

- Chart G (page 532)

Materials

- Stranded silver-plated copper conductors
- PTFE insulation
- Silver-plated copper braid shield, 90% coverage
- White PTFE tape jacket

Availability

100 ft (30.5 m)

1000 ft (305 m)*

*May contain multiple lengths

18 AWG (0.96 mm²)

Stranding: 19/30 (19 x 0.25 mm)
Insulation thickness: 0.010 (0.25 mm)

Part No.	Conductors	Nominal Diameter		Jacket Thickness	
		Inch	mm	Inch	mm
2829/2	2	0.186	4.72	0.012	0.30
2829/3	3	0.197	5.00	0.012	0.30
2829/4	4	0.215	5.46	0.012	0.30

16 AWG (1.23 mm²)

Stranding: 19/29 (19 x 0.29 mm)
Insulation thickness: 0.012 (0.30 mm)

Part No.	Conductors	Nominal Diameter		Jacket Thickness	
		Inch	mm	Inch	mm
2826	1	0.122	3.10	0.010	0.25
2826/2	2	0.206	5.23	0.012	0.30
2826/3	3	0.219	5.56	0.012	0.30
2826/4	4	0.240	6.10	0.012	0.30

Communication and Control

300 V Multiconductor, SR-PVC, PVC Foil/Braid Shield

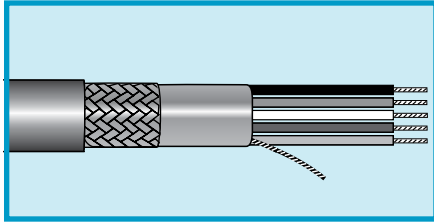

UL AWM 2464 VW-1
UL CL2
CSA CMG FT4

Operating Temperature

- -20°C to +80°C (AWM)
- -20°C to +75°C (CL2)
- -20°C to +60°C (CMG)

Conductor Color Coding

- Chart D (page 531)

Materials

- Stranded tinned copper conductors
- Semirigid PVC insulation
- Foil + braid shield
Aluminum/polyester/aluminum foil shield, 25% overlap min.
Foil facing outward
- Stranded tinned copper drain wire equal in size to the conductor
- Slate PVC jacket

Availability

100 ft (30.5 m)
500 ft (152 m)
1000 ft (305 m)

28 AWG (0.08 mm²)

Stranding: 7/36 (7 x 0.13 mm)
Insulation thickness: 0.010 (0.25 mm)

Part No.	Conductors	Nominal Diameter		Jacket Thickness	
		Inch	mm	Inch	mm
3463*	3	0.171	4.34	0.035	0.89
3464C	4	0.181	4.60	0.035	0.89
3465C	5	0.191	4.85	0.035	0.89
3466C	6	0.202	5.13	0.035	0.89
3467C	7	0.202	5.13	0.035	0.89
3468C	8	0.212	5.38	0.035	0.89
3469C	9	0.223	5.66	0.035	0.89
3470C	10	0.236	5.99	0.035	0.89
3470/15C	15	0.267	6.78	0.035	0.89
3470/25C	25	0.312	7.92	0.035	0.89
3470/37C	37	0.347	8.81	0.035	0.89
3470/50C	50	0.397	10.08	0.035	0.89

*UL AWM 2464/CSA CMG only.



Low Capacitance Data Cable

300 V Multiconductor, FPP, PVC
Foil/Braid Shield

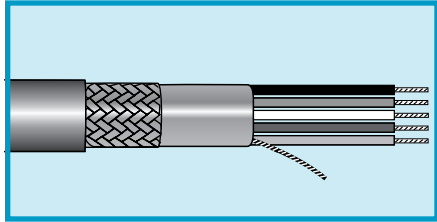

UL AWM 2919 (30 V) VW-1
UL CL2
CSA CMG FT4

Operating Temperature

- -20°C to +80°C (AWM)
- -20°C to +75°C (CL2)
- -20°C to +60°C (CMG)

Conductor Color Coding

- Chart D (page 531) for 3-conductor to 9-conductor cables
- Chart F (page 532) for 25-conductor cables

Materials

- Stranded tinned copper conductors
- Foam polypropylene insulation
- Foil + braid shield
Aluminum/polyester/aluminum foil shield, 25% overlap min.
Foil facing outward
Stranded tinned copper drain wire equal in size to conductor
Tinned copper braid shield, 65% coverage
- Slate PVC jacket

Availability

1000 ft (305 m)

28 AWG (0.08 mm²)

Stranding: 7/36 (7 x 0.13 mm)
Insulation thickness: 0.013 (0.33 mm)

Part No.*	Conductors	Nominal Diameter		Jacket Thickness	
		Inch	mm	Inch	mm
3483	3	0.184	4.67	0.035	0.89
3484C	4	0.195	4.95	0.035	0.89
3488C	8	0.232	5.89	0.035	0.89
3489C	9	0.245	6.22	0.035	0.89
3490/25C	25	0.348	8.84	0.035	0.89

Mutual capacitance: 12 pF/ft (39.4 pF/m)
Ground capacitance: 20 pF/ft (65.6 pF/m)

*C suffix part no. are CL2 approved.



Communication and Control

300 V Multiconductor, SR-PVC, PVC
Overall Foil/Braid Shield

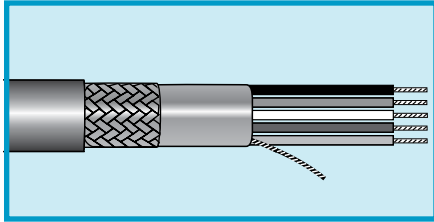

UL AWM 2464 VW-1
UL CM
CSA CMG FT4

Operating Temperature

- -20°C to +80°C (AWM)
- -20°C to +75°C (CM)
- -20°C to +60°C (CMG)

Conductor Color Coding

- Chart F (page 532) for 15-conductor through 50-conductor cables
- See table below for 3-conductor through 10-conductor cables

Materials

- Stranded tinned copper conductors
- Semirigid PVC insulation
- Foil + braid shield
Aluminum/polyester foil shield, 25% overlap min.
Foil facing outward
- Stranded tinned copper drain wire, 24 AWG (0.22 mm²), 7/32 (7 x 0.22 mm)
- Tinned copper braid, 65% coverage
- Slate PVC jacket

Availability

100 ft (30.5 m)
500 ft (152 m)
1000 ft (305 m)

24 AWG (0.22 mm²)

Stranding: 7/32 (7 x 0.20 mm)
Insulation thickness: 0.010 (0.25 mm)

Part No.	Conductors	Nominal Diameter		Jacket Thickness	
		Inch	mm	Inch	mm
6327	3	0.185	4.70	0.032	0.81
6328	4	0.196	4.98	0.032	0.81
6329	5	0.209	5.31	0.032	0.81
6330	6	0.223	5.66	0.032	0.81
6331	7	0.223	5.66	0.032	0.81
6332	8	0.236	5.99	0.032	0.81
6333	9	0.250	6.35	0.032	0.81
6334	10	0.266	6.76	0.032	0.81
6335	15	0.292	7.42	0.032	0.81
6336	25	0.354	8.99	0.032	0.81
6337	37	0.398	10.11	0.032	0.81
6338	50	0.449	11.40	0.032	0.81

Mutual capacitance: 32 pF/ft (105 pF/m)
Ground capacitance: 58 pF/ft (190 pF/m)

22 AWG (0.35 mm²)

Stranding: 7/30 (7 x 0.25 mm)
Insulation thickness: 0.010 (0.25 mm)

Part No.	Conductors	Nominal Diameter		Jacket Thickness	
		Inch	mm	Inch	mm
6339	3	0.198	5.03	0.032	0.81
6340	4	0.211	5.36	0.032	0.81
6341	5	0.226	5.74	0.032	0.81
6342	6	0.241	6.12	0.032	0.81
6343	7	0.241	6.12	0.032	0.81
6344	8	0.256	6.50	0.032	0.81
6345	9	0.272	6.91	0.032	0.81
6346	10	0.290	7.37	0.032	0.81
6347	15	0.320	8.13	0.032	0.81
6348	25	0.390	9.91	0.032	0.81
6349	37	0.440	11.18	0.032	0.81
6350	50	0.540	13.72	0.053	1.35

Mutual capacitance: 36 pF/ft (118 pF/m)
Ground capacitance: 65 pF/ft (213 pF/m)

Color Coding: 3 through 10 Conductors

1 Black	6 Blue
2 White	7 Orange
3 Red	8 Yellow
4 Green	9 Violet
5 Brown	10 Slate



Communication and Control

300 V Foil/Braid Shield, Multiconductor, FPE, PVC Low Capacitance Data Cable

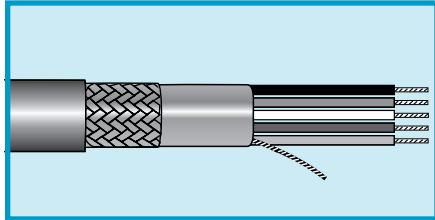

**UL AWM 2919 (30 V) VW-1
UL CM
CSA CMH FT1**

Operating Temperature

- -20°C to +80°C (AWM)
- -20°C to +75°C (CM)
- -20°C to +60°C (CMH)

Conductor Color Coding

- Chart F (page 532) for 15 through 37 conductors. Other parts, see table at right.

Materials

- Stranded tinned copper conductors
- Foam polyethylene insulation
- Foil + braid shield
Aluminum/polyester foil shield,
25% overlap min.
Foil facing outward
- Stranded tinned copper drain wire equal in size to conductor
- Tinned copper braid,
65% coverage
- Slate PVC jacket

Availability

100 ft (30.5 m)
500 ft (152 m)
1000 ft (305 m)

24 AWG (0.22 mm²)

Stranding: 7/32 (7 x 0.20 mm)
Insulation thickness: 0.016 (0.41 mm)

Part No.	Conductors	Nominal Diameter		Jacket Thickness	
		Inch	mm	Inch	mm
6351	3	0.217	5.51	0.035	0.89
6352	4	0.231	5.87	0.035	0.89
6353	5	0.248	6.30	0.035	0.89
6354	6	0.265	6.73	0.035	0.89
6355	7	0.265	6.73	0.035	0.89
6356	8	0.282	7.16	0.035	0.89
6357	9	0.300	7.62	0.035	0.89
6358	10	0.320	8.13	0.035	0.89
6359	15	0.353	8.97	0.035	0.89
6360	25	0.432	10.97	0.035	0.89
6361	37	0.514	13.06	0.048	1.22

Mutual capacitance: 12 pF/ft (39.4 pF/m)
Ground capacitance: 22 pF/ft (72.2 pF/m)

Color Coding

1 Black	5 Brown	9 Violet
2 White	6 Blue	10 Slate
3 Red	7 Orange	
4 Green	8 Yellow	



Communication and Control

300 V Unshielded, Multipair, PVC, PVC

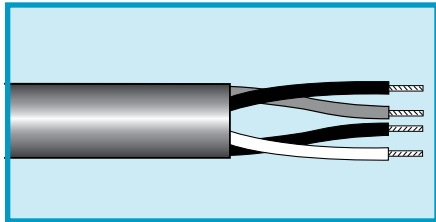

**UL AWM 2464, 2576 VW-1
UL CM
CSA CMG FT4**

Operating Temperature

- -20°C to +80°C (AWM)
- -20°C to +75°C (CM)
- -20°C to +60°C (CMG)

Conductor Color Coding

- Chart A (page 528)

Materials

- Stranded tinned copper conductors
- PVC insulation
- Slate PVC jacket

Availability

1000 ft (305 m)

22 AWG (0.32 mm²)

Stranding: Solid
Insulation thickness: 0.010 (0.25 mm)

Part No.	Pairs	Nominal Diameter		Jacket Thickness	
		Inch	mm	Inch	mm
1300C	1	0.157	3.99	0.032	0.81
1302C	2	0.215	5.46	0.032	0.81
1304C	3	0.226	5.74	0.032	0.81
1305C	4	0.246	6.25	0.032	0.81
1306C	5	0.267	6.78	0.032	0.81
1307C	6	0.289	7.34	0.032	0.81
1308/11C	11	0.362	9.19	0.032	0.81
1309C	13	0.382	9.70	0.032	0.81
1310C	16	0.414	10.52	0.032	0.81
1313C	27	0.537	13.64	0.040	1.02

UL AWM 2576

22 AWG (0.35 mm²)

Stranding: 7/30 (7 x 0.25 mm)
Insulation thickness: 0.010 (0.25 mm)

Part No.	Pairs	Nominal Diameter		Jacket Thickness	
		Inch	mm	Inch	mm
1317C	2	0.231	5.87	0.032	0.81
1318C	3	0.244	6.20	0.032	0.81
1319C	4	0.265	6.73	0.032	0.81
1320C	5	0.289	7.34	0.032	0.81
1322C	6	0.320	8.13	0.035	0.89
1323C	9	0.371	9.42	0.035	0.89
1324C	11	0.401	10.19	0.035	0.89
1325C	12	0.414	10.52	0.035	0.89
1327C	15	0.460	11.68	0.040	1.02
1327/19C	19	0.493	12.52	0.040	1.02

UL AWM 2464

18AWG (0.81 mm²)

Stranding: 16/30 (16 x 0.25 mm)
Insulation thickness: 0.016 (0.41 mm)

Part No.	Pairs	Nominal Diameter		Jacket Thickness	
		Inch	mm	Inch	mm
1131C	1	0.225	5.72	0.032	0.81
1132C	2	0.332	8.43	0.035	0.89
1133C	3	0.356	9.04	0.037	0.94
1134C	4	0.396	10.06	0.040	1.02
1135C	5	0.444	11.28	0.045	1.14
1136C	6	0.484	12.29	0.045	1.14
1138C	8	0.534	13.56	0.050	1.27
1139C	9	0.584	14.83	0.055	1.40
1149C	19	0.791	20.09	0.070	1.78



Communication and Control

300 V Overall Foil Shield, Multipair, SR-PVC, PVC

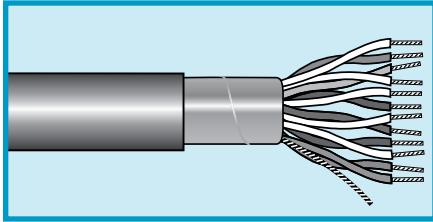

UL AWM 2464
UL CM
CSA CMG FT4

Operating Temperature

- -20°C to +80°C (AWM)
- -20°C to +75°C (CM)
- -20°C to +60°C (CMG)

Conductor Color Coding

- Chart K (page 529)

Materials

- Stranded tinned copper conductors
- Semirigid PVC insulation
- Aluminum/polyester foil shield, 25% overlap min.
Foil facing inward
- Stranded tinned copper drain wire equal in size to conductor
- Slate PVC jacket

Availability

100 ft (30.5 m)
 500 ft (152 m)
 1000 ft (305 m)

24 AWG (0.23 mm²)

Stranding: 7/32 (7 x 0.20 mm)
 Insulation thickness: 0.010 (0.25 mm)

Part No.	Pairs	Nominal Diameter		Jacket Thickness	
		Inch	mm	Inch	mm
5471C	1	0.156	3.96	0.032	0.81
5472C	2	0.212	5.38	0.032	0.81
5473C	3	0.224	5.69	0.032	0.81
5474C	4	0.243	6.17	0.032	0.81
5475C	5	0.270	6.86	0.035	0.89
5476C	6	0.292	7.42	0.035	0.89
5477C	7	0.292	7.42	0.035	0.89
5478C	8	0.316	8.03	0.035	0.89
5479C	9	0.343	8.71	0.037	0.83
5480C	10	0.373	9.47	0.040	1.02
5480/15C	15	0.415	10.54	0.040	1.02
5480/19C	19	0.445	11.30	0.040	1.02
5480/25C	25	0.527	13.39	0.045	1.14
5480/50C *	50	0.699	17.75	0.053	1.35

*Color code chart C.

Individually Shielded, 22 AWG (0.35 mm²), 7/30 (7 x .025) Tinned Copper Drain Wire UL VW-1

20 AWG (0.56 mm²)

Stranding: 7/28 (7 x 0.33 mm)
 Insulation thickness: 0.010 (0.25 mm)

Part No.	Pairs	Nominal Diameter		Jacket Thickness	
		Inch	mm	Inch	mm
6416	2	0.295	7.49	0.041	1.04

Mutual capacitance: 55 pF/ft (180 pF/m)
 Ground capacitance: 95 pF/ft (312 pF/m)



Communication and Control

300 V Overall Foil Shield, Multipair, PVC, PVC

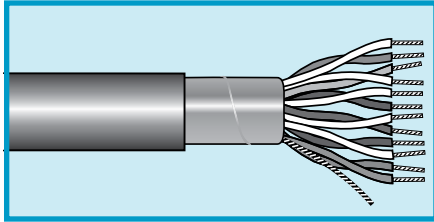

UL AWM 2464 VW-1
UL CM
CSA CMG FT4

Operating Temperature

- -20°C to +80°C (AWM)
- -20°C to +75°C (CM)
- -20°C to +60°C (CMG)

Conductor Color Coding

- Chart K (page 529)

Materials

- Solid tinned copper conductors
- PVC insulation
- Aluminum/polyester foil shield, 25% overlap min.
Foil facing inward
- Stranded tinned copper drain wire equal in size to conductor
- Slate PVC jacket

Availability

100 ft (30.5 m)
 500 ft (152 m)
 1000 ft (305 m)

22 AWG (0.32 mm ²)					
Stranding: Solid Insulation thickness: 0.013 (0.33 mm)					
Part No.	Pairs	Nominal Diameter		Jacket Thickness	
		Inch	mm	Inch	mm
5902C	2	0.238	6.05	0.032	0.81
5905C	4	0.273	6.93	0.032	0.81
5906C	6	0.329	8.36	0.035	0.89
5909C	9	0.385	9.78	0.037	0.94
5909/15C	15	0.471	11.96	0.040	1.02
5909/19C	19	0.506	12.85	0.040	1.02



Communication and Control

150 and 300 V Overall Foil Shield, Multipair, PVC, PVC

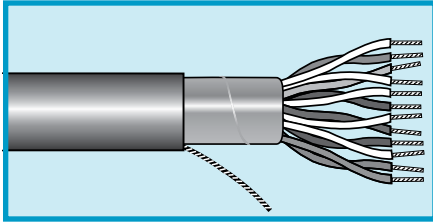

UL AWM 2576 VW-1 (150 V)
UL AWM 2464 VW-1 (300 V)
UL CM
CSA CMG FT4

Operating Temperature

- -20°C to +80°C (AWM)
- -20°C to +75°C (CM)
- -20°C to +60°C (CMG)

Conductor Color Coding

- Chart A (page 528)

Materials

- Stranded tinned copper conductors
- PVC insulation
- Aluminum/polyester foil shield, 25% overlap min.
Foil facing outward
Stranded tinned copper drain wire equal in size to conductor
- Slate PVC jacket

Availability

100 ft (30.5 m)
 500 ft (152 m)
 1000 ft (305 m)

150 V, AWM 2576

22 AWG (0.35 mm²)

Stranding: 7/30 (7 x 0.25 mm)
 Insulation thickness: 0.010 (0.25 mm)

Part No.	Pairs	Nominal Diameter		Jacket Thickness	
		Inch	mm	Inch	mm
2211C	1	0.168	4.27	0.032	0.81
2212C	2	0.232	5.89	0.032	0.81
2213C	3	0.245	6.22	0.032	0.81
2214C	4	0.266	6.76	0.032	0.81
2215C	5	0.290	7.37	0.032	0.81
2216C	6	0.315	8.00	0.032	0.81
2219C	9	0.372	9.45	0.035	0.89
2219/12C	12	0.415	10.54	0.035	0.89
2219/15C	15	0.451	11.46	0.035	0.89
2219/19C	19	0.494	12.55	0.040	1.02
2219/23C	23	0.545	13.84	0.040	1.02
2219/27C	27	0.589	14.96	0.040	1.02

300 V, AWM 2464

18 AWG (0.81 mm²)

Stranding: 16/30 (16 x 0.25 mm)
 Insulation thickness: 0.016 (0.41 mm)

Part No.	Pairs	Nominal Diameter		Jacket Thickness	
		Inch	mm	Inch	mm
2241C	1	0.226	5.74	0.032	0.81
2242C	2	0.333	8.46	0.035	0.89
2243C	3	0.357	9.07	0.037	0.94
2244C	4	0.397	10.08	0.040	1.02
2245C	5	0.445	11.30	0.045	1.14
2246C	6	0.485	12.32	0.045	1.14
2249C	9	0.585	14.86	0.055	1.40
2249/12C	12	0.652	16.56	0.055	1.40
2249/19C	19	0.792	20.12	0.070	1.78



Communication and Control

300 V Overall Foil Shield, Multipair, PVC, PVC

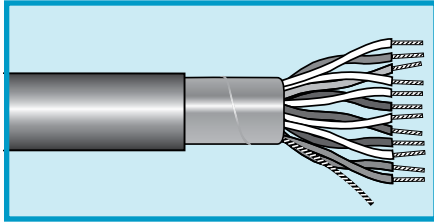

UL PLTC/CM
UL VW-1
UL Sunlight Resistant
CSA CMG FT4

Operating Temperature

- -20°C to +105°C (CM)
- -20°C to +60°C (CMG)

Conductor Color Coding

- Black and red pairs, numbered

Materials

- Stranded tinned copper conductors
- PVC insulation
- Aluminum/polyester foil shield, 25% overlap min. Foil facing inward
- Stranded tinned copper drain wire, 24 AWG (0.22 mm²), 7/32 (7 x 0.20)
- Slate PVC jacket

Availability

500 ft (152 m)
 1000 ft (305 m)

22 AWG (0.35 mm²)

Stranding: 7/30 (7 x 0.25 mm)
 Insulation thickness: 0.013 (0.33 mm)

Part No.	Pairs	Nominal Diameter		Jacket Thickness	
		Inch	mm	Inch	mm
6417	2	0.267	6.78	0.038	0.97
6418	3	0.291	7.39	0.043	1.09
6419	4	0.315	8.00	0.043	1.09
6420	6	0.370	9.40	0.043	1.09
6421	9	0.447	11.35	0.053	1.35
6422	11	0.480	12.19	0.053	1.35
6423	15	0.545	13.84	0.053	1.35
6424	19	0.593	15.06	0.063	1.60
6425	27	0.698	17.73	0.063	1.60
6426	51	0.914	23.22	0.075	1.91

18 AWG (0.96 mm²)

Stranding: 19/30 (19 x 0.25 mm)
 Insulation thickness: 0.016 (0.41 mm)

Part No.	Pairs	Nominal Diameter		Jacket Thickness	
		Inch	mm	Inch	mm
6427	2	0.362	9.19	0.043	1.09
6428	3	0.403	10.24	0.053	1.35
6429	4	0.438	11.13	0.053	1.35
6430	6	0.518	13.16	0.053	1.35
6431	9	0.622	15.80	0.063	1.60
6432	11	0.671	17.04	0.063	1.60
6433	15	0.751	19.08	0.063	1.60



Communication and Control

300 V Overall Foil Shield, Multipair, HDPE, PVC
 Low Capacitance, Extended Distance Cable

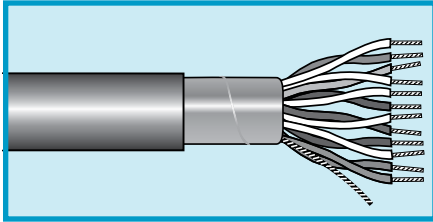

**UL AWM 2919 (30 V) VW-1
 UL CM
 CSA CMG FT4**

Operating Temperature

- -20°C to +80°C (AWM)
- -20°C to +75°C (CM)
- -20°C to +60°C (CMG)

Conductor Color Coding

- Chart M (page 530)

Materials

- Stranded tinned copper conductors
- High-density polyethylene insulation
- Aluminum/polyester/aluminum foil shield, 25% overlap min.
 Stranded tinned copper drain wire equal in size to conductor
- Slate PVC jacket

Availability

100 ft (30.5 m)
 500 ft (152 m)
 1000 ft (305 m)

24 AWG (0.22 mm²)

Stranding: 7/32 (7 x 0.20 mm)
 Insulation thickness: 0.010 (0.25 mm)

Part No.	Pairs	Nominal Diameter		Jacket Thickness	
		Inch	mm	Inch	mm
6083C	3	0.235	5.97	0.035	0.89
6084C	4	0.254	6.45	0.035	0.89
6087C	7	0.297	7.54	0.035	0.89
6089C	9	0.342	8.69	0.035	0.89
6089/18C	18	0.440	11.18	0.035	0.89

Characteristic impedance: 100 ohms
 Mutual capacitance: 15 pF/ft (49.2 pF/m)
 Ground capacitance: 27 pF/ft (88.6 pF/m)



Communication and Control

300 V Overall Foil Shield, Multipair, PE, PVC
 Low Capacitance Data Cable

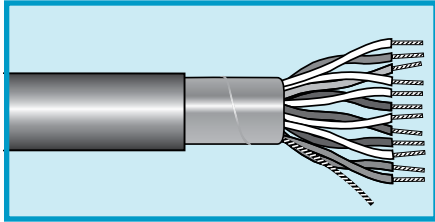

24 AWG (0.22 mm²)

Stranding: 7/32 (7 x 0.20 mm)
 Insulation thickness: 0.016 (0.41 mm)

Part No.	Pairs	Nominal Diameter		Jacket Thickness	
		Inch	mm	Inch	mm
6301	6	0.351	8.92	0.035	0.89
6304	12.5	0.455	11.56	0.035	0.89

Characteristic impedance: 120 ohms
 Mutual capacitance: 12.8 pF/ft (42 pF/m)
 Ground capacitance: 23 pF/ft (75.4 pF/m)

UL AWM 2919 (30 V) VW-1
UL CM
CSA CMH FT1

Operating Temperature

- -20°C to +80°C (AWM)
- -20°C to +75°C (CM)
- -20°C to +60°C (CMH)

Conductor Color Coding

- Chart M (page 530)

Materials

- Stranded tinned copper conductors
- Polyethylene insulation
- Aluminum/polyester foil shield, 25% overlap min.
 Foil facing outward
- Stranded tinned copper drain wire equal in size to conductor
- Slate PVC jacket

Availability

100 ft (30.5 m)
 500 ft (152 m)
 1000 ft (305 m)



Communication and Control

300 V Overall Foil Shield, Multipair, FPP, PVC Low Capacitance Data Cable

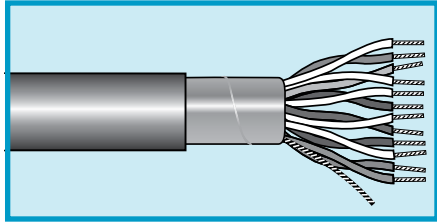

**UL AWM 2919 (30 V) VW-1
UL CM
CSA CMG FT4**

Operating Temperature

- -20°C to +80°C (AWM)
- -20°C to +75°C (CM)
- -20°C to +60°C (CMG)

Conductor Color Coding

- Chart A (page 528)

Materials

- Stranded tinned copper conductors
- Foam polypropylene insulation
- Aluminum/polyester foil shield, 25% overlap min.
Foil facing outward
- Stranded tinned copper drain wire equal in size to conductor
- Slate PVC jacket

Availability

500 ft (152 m)
1000 ft (305 m)

24 AWG (0.22 mm²)

Stranding: 7/32 (7 x 0.20 mm)
Insulation thickness: 0.016 (0.41 mm)

Part No.	Pairs	Nominal Diameter		Jacket Thickness	
		Inch	mm	Inch	mm
6202C	2	0.258	6.55	0.035	0.89
6203C	3	0.272	6.91	0.035	0.89
6204C	4.5*	0.304	7.72	0.035	0.89
6205C	5	0.323	8.20	0.035	0.89
6206C	6	0.351	8.92	0.035	0.89
6207C	7	0.351	8.92	0.035	0.89
6208C	8	0.379	9.63	0.035	0.89
6209C	9	0.408	10.36	0.035	0.89
6210C	10	0.441	11.20	0.035	0.89
6210/12C	12.5*	0.455	11.56	0.035	0.89
6210/15C	15	0.496	12.60	0.035	0.89
6210/18C	18.5*	0.554	14.07	0.050	1.27
6210/25C	25	0.655	16.64	0.050	1.27

*Single conductor colors: 4.5 = black, 12.5 = red, 18.5 = white

Characteristic impedance: 105 ohms
Mutual capacitance: 12.5 pF/ft (41 pF/m)
Ground capacitance: 22 pF/ft (72 pF/m)

22 AWG (0.35 mm²)

Stranding: 7/30 (7 x 0.25 mm)
Insulation thickness: 0.020 (0.51 mm)

Part No.	Pairs	Nominal Diameter		Jacket Thickness	
		Inch	mm	Inch	mm
6212C	2	0.304	7.72	0.035	0.89
6213C	3	0.322	8.18	0.035	0.89
6216C	6	0.420	10.67	0.035	0.89
6217C	7	0.420	10.67	0.035	0.89
6218C	8	0.456	11.58	0.035	0.89
6220C	10	0.563	14.30	0.050	1.27
6220/12C	12.5*	0.580	14.73	0.050	1.27
6220/15C	15	0.631	16.03	0.050	1.27
6220/18C	18.5*	0.667	16.94	0.050	1.27
6220/25C	25	0.793	20.14	0.050	1.27

*Single conductor colors: 12.5 = red, 18.5 = white

Characteristic impedance: 105 ohms
Mutual capacitance: 12.5 pF/ft (41 pF/m)
Ground capacitance: 22 pF/ft (72 pF/m)



Communication and Control

600 V Overall Foil Shield, Multipair, PE, PVC

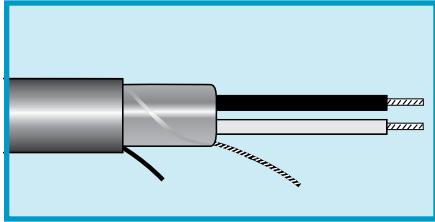

UL AWM 2106 VW-1

Operating Temperature

- 20°C to +60°C

Conductor Color Coding

- Black, clear

Materials

- Stranded tinned copper conductors
- Polyethylene insulation
- Aluminum/polyester foil shield, 25% overlap min.
Foil facing outward
- Stranded tinned copper drain wire one even AWG size smaller than conductor
- Slate PVC jacket

Availability

- 100 ft (30.5 m)
- 500 ft (152 m)
- 1000 ft (305 m)

16 AWG (1.32 mm²)

Stranding: 19/0.0117 (19 x 0.30 mm)
Insulation thickness: 0.032 (0.81 mm)

Part No.	Pairs	Nominal Diameter		Jacket Thickness	
		Inch	mm	Inch	mm
2471	1	0.314	7.98	0.035	0.89

Mutual capacitance: 20.5 pF/ft (67.3 pF/m)
Ground capacitance: 37 pF/ft (121.4 pF/m)

14 AWG (1.94 mm²)

Stranding: 19/27 (19 x 0.36 mm)
Insulation thickness: 0.032 (0.81 mm)

Part No.	Pairs	Nominal Diameter		Jacket Thickness	
		Inch	mm	Inch	mm
2472	1	0.344	8.74	0.035	0.89

Mutual capacitance: 22.7 pF/ft (74.5 pF/m)
Ground capacitance: 41 pF/ft (134.5 pF/m)

12 AWG (3.08 mm²)

Stranding: 19/25 (19 x 0.45 mm)
Insulation thickness: 0.037 (0.94 mm)

Part No.	Pairs	Nominal Diameter		Jacket Thickness	
		Inch	mm	Inch	mm
2473	1	0.412	10.46	0.040	1.02

Mutual capacitance: 23.9 pF/ft (78.4 pF/m)
Ground capacitance: 43 pF/ft (141.1 pF/m)

Communication and Control

400 V Multiconductor, Multipair, PE, PVC
Foil Shielded Pairs and Overall Foil Shield

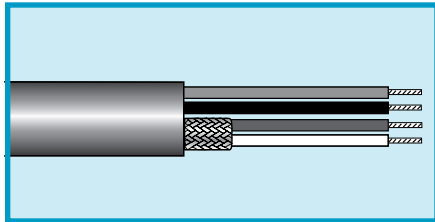

25 AWG (0.18 mm ²)						
Stranding: 3/33 TC +4/33 TCW (3 x 0.18 +4 x 0.18 mm)						
Insulation thickness: 0.013 (0.33 mm)						
Part No.	Conductors	Pairs	Nominal Diameter		Jacket Thickness	
			Inch	mm	Inch	mm
2468	2	1	0.165	4.19	0.020	0.51

Operating Temperature

- -20°C to +60°C

Conductor Color Coding

- Conductors: 1 White, 2 Green
Pair: Black-Red

Materials

- Stranded tinned and steel-coated copper conductors
- Polyethylene insulation
- Aluminum/polyester foil shield, 25% overlap min.
Foil facing outward
- Stranded tinned copper drain wire, 25 AWG (0.18 mm²), 7/33 (7 x 0.18 mm)
- Slate PVC jacket

Availability

100 ft (30.5 m)
500 ft (152 m)
1000 ft (305 m)



Communication and Control

300 V Overall Foil/Braid Shield, Multipair, SR-PVC, PVC

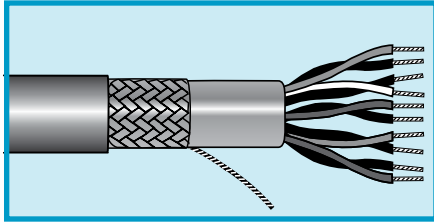

UL AWM 2464 VW-1
UL CL2
CSA CMG FT4

Operating Temperature

- -20°C to +80°C (AWM)
- -20°C to +75°C (CL2)
- -20°C to +60°C (CMG)

Conductor Color Coding

- Chart A (page 528)

Materials

- Stranded tinned copper conductors
- Semirigid PVC insulation
- Foil + braid shield
 Aluminum/polyester foil shield,
 25% overlap min.
 Foil facing outward
 Stranded tinned copper drain
 wire equal in size to conductor
 Tinned copper braid,
 65% coverage
- Slate PVC jacket

Availability

100 ft (30.5 m)
 500 ft (152 m)
 1000 ft (305 m)

28 AWG (0.09 mm²)

Stranding: 7/36 (7 x 0.13 mm)
 Insulation thickness: 0.010 (0.25 mm)

Part No.	Pairs	Nominal Diameter		Jacket Thickness		Availability
		Inch	mm	Inch	mm	
3472C	2	0.211	5.36	0.035	0.89	100
3474C	4	0.235	5.97	0.035	0.89	100
3475C	5	0.258	6.55	0.035	0.89	100, 1000
3476C	6	0.275	6.99	0.035	0.89	100
3477C	7	0.275	6.99	0.035	0.89	100
3480C	10	0.332	8.43	0.035	0.89	100, 500, 1000
3480/12C	12.5	0.342	8.69	0.035	0.89	100, 500, 1000
3480/18C	18	0.389	9.88	0.035	0.89	100, 500, 1000
3480/25C	25	0.446	11.33	0.035	0.89	100, 500, 1000



Communication and Control

300 V Overall Foil/Braid Shield, Multipair, SR-PVC, PVC

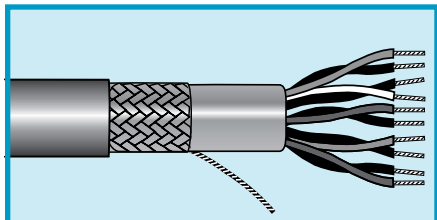

UL AWM 2464 VW-1
UL CM
CSA CMG FT4

Operating Temperature

- -20°C to +80°C (AWM)
- -20°C to +75°C (CM)
- -20°C to +60°C (CMG)

Conductor Color Coding

- See tables

Materials

- Stranded tinned copper conductors
- Semirigid PVC insulation
- Foil + braid shield
 Aluminum/polyester foil, 25% overlap min.
 Foil facing outward
 Stranded tinned copper drain wire, 24 AWG (0.23 mm²), 7/32 (7 x 0.20 mm)
 Tinned copper braid, 65% coverage
- Slate PVC jacket

Availability

100 ft (30.5 m)
 500 ft (152 m)
 1000 ft (305 m)

24 AWG (0.23 mm²)

Stranding: 7/32 (7 x 0.20 mm)
 Insulation thickness: 0.010 (0.25 mm)

Part No.	Pairs	Nominal Diameter		Jacket Thickness		Color Code
		Inch	mm	Inch	mm	
6362	2	0.234	5.94	0.032	0.81	M
6363	3	0.246	6.25	0.032	0.81	M
6364	4	0.265	6.73	0.032	0.81	M
6365	5	0.286	7.26	0.032	0.81	M
6366	6	0.308	7.82	0.032	0.81	M
6367	7	0.308	7.82	0.032	0.81	M
6368	10	0.379	9.63	0.032	0.81	M
6369	12.5	0.389	9.62	0.032	0.81	M
6370	15	0.421	10.69	0.032	0.81	M
6371	18	0.451	11.46	0.032	0.81	M
6372	25	0.523	13.28	0.032	0.81	M

22 AWG (0.35 mm²)

Stranding: 7/30 (7 x 0.25mm)
 Insulation thickness: 0.010 (0.25 mm)

Part No.	Pairs	Nominal Diameter		Jacket Thickness		Color Code
		Inch	mm	Inch	mm	
6373	2	0.254	6.45	0.032	0.81	A
6374	3	0.267	6.78	0.032	0.81	A
6375	4	0.288	7.32	0.032	0.81	A
6376	5	0.312	7.92	0.032	0.81	Chart below
6377	6	0.337	8.56	0.032	0.81	A
6378	7	0.337	8.56	0.032	0.81	A
6379	8	0.363	9.22	0.032	0.81	Chart below
6380	10	0.418	10.62	0.032	0.81	A
6381	12.5	0.430	10.92	0.032	0.81	A
6382	15	0.467	11.86	0.032	0.81	A
6383	18	0.500	12.70	0.032	0.81	A
6384	25	0.595	15.11	0.032	0.81	A

Color Code Chart (Part No. 6376 and 6379)

Pair No.	Color	Pair No.	Color
1	Black, Red	5	Black, Yellow
2	Black, White	6	Black, Brown
3	Black, Green	7	Black, Orange
4	Black, Blue	8	Red, White



Communication and Control

300 V Overall Foil/Braid Shield, Multipair, PE, PVC
 Low Capacitance Data Cable

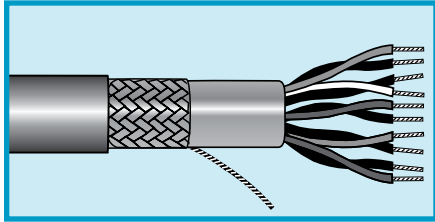

UL AWM 2960 VW-1
UL CL2
CSA CMH FT1

Operating Temperature

- -20°C to +75°C (CL2)
- -20°C to +60°C (AWM, CMH)

Conductor Color Coding

- Chart K (page 529)

Materials

- Stranded tinned copper conductors
- Polyethylene insulation
- Foil + braid shielding
 Aluminum/polyester foil shield,
 25% overlap min.
 Foil facing outward
 Stranded tinned copper drain
 wire equal in size to conductor
 Tinned copper braid,
 90% coverage
- Slate PVC jacket

Availability

100 ft (30.5 m)
 500 ft (152 m)
 1000 ft (305 m)

28 AWG (0.089 mm²)

Stranding: 7/36 (7 x 0.13 mm)
 Insulation thickness: 0.010 (0.25 mm)

Part No.	Pairs	Nominal Diameter		Jacket Thickness	
		Inch	mm	Inch	mm
6390	2	0.211	5.36	0.035	0.89
6391	3	0.220	5.59	0.035	0.89
6392	4	0.235	5.97	0.035	0.89
6393	5	0.252	6.40	0.035	0.89
6394	7	0.269	6.83	0.035	0.89
6395	9	0.305	7.75	0.035	0.89
6396	12	0.335	8.51	0.035	0.89
6397	13	0.341	8.66	0.035	0.89
6398	18	0.383	9.73	0.035	0.89
6399	25	0.440	11.18	0.035	0.89
6400	31	0.470	11.94	0.035	0.89

Characteristic impedance: 100 ohms
 Mutual capacitance: 15.5 pF/ft (50.9 pF/m)
 Ground capacitance: 27.5 pF/ft (90.2 pF/m)



Communication and Control

300 V Overall Foil/Braid Shield, Multipair, PE, PVC Low Capacitance Data Cable

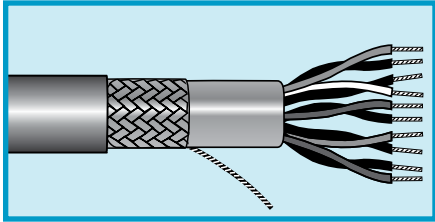

UL AWM 2919 VW-1
UL CM
CSA CM FT1

Operating Temperature

- -20°C to +80°C (AWM)
- -20°C to +75°C (CM)

Conductor Color Coding

- Chart M (page 530)

Materials

- Stranded tinned copper conductors
- Polyethylene insulation
- Foil + braid shielding
Aluminum/polyester foil shield,
25% overlap min.
Foil facing outward
Stranded tinned copper drain
wire equal in size to conductor
Tinned copper braid, 65% or
90% coverage
- Slate PVC jacket

Availability

100 ft (30.5 m)
500 ft (152 m)
1000 ft (305 m)

24 AWG (0.23 mm²)

Stranding: 7/32 (7 x 0.20 mm)
Insulation thickness: 0.016 (0.41 mm)
65% braid coverage

Part No.	Pairs	Nominal Diameter		Jacket Thickness	
		Inch	mm	Inch	mm
6401	2	0.280	7.11	0.035	0.89
6402	3	0.294	7.47	0.035	0.89
6403	4	0.318	8.08	0.035	0.89
6404	5	0.345	8.76	0.035	0.89
6405	6	0.373	9.47	0.035	0.89
6406	7	0.373	9.47	0.035	0.89
6407	9	0.430	10.92	0.035	0.89
6408	10	0.463	11.76	0.035	0.89
6409	12	0.478	12.14	0.035	0.89
6410	18	0.580	14.73	0.047	1.19
6411	25	0.671	17.04	0.047	1.19

Characteristic impedance: 100 ohms
Mutual capacitance: 15.5 pF/ft (50.9 pF/m)
Ground capacitance: 27.5 pF/ft (90.2 pF/m)

24 AWG (0.23 mm²)

Stranding: 7/32 (7 x 0.20 mm)
Insulation thickness: 0.016 (0.41 mm)
90% braid coverage

Part No.	Pairs	Nominal Diameter		Jacket Thickness	
		Inch	mm	Inch	mm
6412	1	0.208	5.28	0.035	0.89
6413	2	0.280	7.11	0.035	0.89
6414	3	0.294	7.47	0.035	0.89
6415	4	0.318	8.08	0.035	0.89

Characteristic impedance: 120 ohms
Mutual capacitance: 12.8 pF/ft (42 pF/m)
Ground capacitance: 23 pF/ft (75.5 pF/m)



Communication and Control

300 V Overall Foil/Braid Shield, Multipair, FPP, PVC
Low Capacitance Data Cable

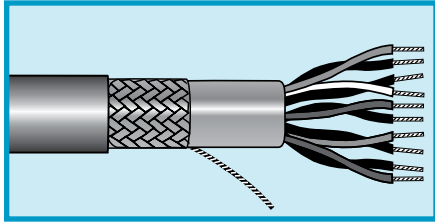

UL AWM 2919 (30 V) VW-1
UL CL2
CSA CMG FT4

Operating Temperature

- -20°C to +80°C (AWM)
- -20°C to +75°C (CL2)
- -20°C to +60°C (CMG)

Conductor Color Coding

- Chart M (page 530)

Materials

- Stranded tinned copper conductors
- Foam polypropylene insulation
- Foil + braid shielding
Aluminum/polyester foil shield,
25% overlap min.
Foil facing outward
- Stranded tinned copper drain wire equal in size to conductor
- Tinned copper braid,
65% coverage
- Slate PVC jacket

Availability

100 ft (30.5 m)
500 ft (152 m)
1000 ft (305 m)

28 AWG (0.089 mm²)

Stranding: 7/36 (7 x 0.13 mm)
Insulation thickness: 0.013 (0.33 mm)

Part No.	Pairs	Nominal Diameter		Jacket Thickness	
		Inch	mm	Inch	mm
3492C	2	0.230	5.84	0.035	0.89
3493C	3	0.241	6.12	0.035	0.89
3494C	4	0.265	6.73	0.035	0.89
3495C	5	0.284	7.21	0.035	0.89
3496C	6	0.305	7.75	0.035	0.89
3498C	8	0.326	8.28	0.035	0.89
3500/12C	12.5	0.381	9.67	0.035	0.89
3500/18C	18	0.439	11.15	0.035	0.89
3500/25C	25	0.531	13.49	0.048	1.22

Mutual capacitance: 12 pF/ft (39.3 pF/m)
Ground capacitance: 20 pF/ft (65.5 pF/m)



Communication and Control

300 V Overall Foil/Braid Shield, Multipair, FPP, PVC Low Capacitance Data Cable

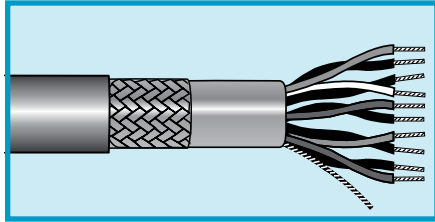

**UL AWM 2919 (30 V) VW-1
UL CM
CSA CMG FT4**

Operating Temperature

- -20°C to +80°C (AWM)
- -20°C to +75°C (CM)
- -20°C to +60°C (CMG)

Conductor Color Coding

- Chart M (page 530)

Materials

- Stranded tinned copper conductors
- Foam polypropylene insulation
- Foil + braid shielding
Aluminum/polyester foil shield,
25% overlap min.
Foil facing outward
Stranded tinned copper drain
wire equal in size to conductor
Tinned copper braid,
65% coverage
- Slate PVC jacket

Availability

500 ft (152 m)
1000 ft (305 m)

24 AWG (0.23 mm ²)					
Stranding: 7/32 (7 x 0.20 mm) Insulation thickness: 0.016 (0.41 mm)					
Part No.	Pairs	Nominal Diameter		Jacket Thickness	
		Inch	mm	Inch	mm
6222C	2	0.280	7.11	0.035	0.89
6223C	3	0.294	7.47	0.035	0.89
6224C	4	0.318	8.08	0.035	0.89
6225C	5	0.345	8.76	0.035	0.89
6226C	6	0.373	9.47	0.035	0.89
6227C	7	0.373	9.47	0.035	0.89
6228C	8	0.401	10.19	0.035	0.89
6230C	10	0.463	11.76	0.035	0.89
6230/12C	12.5	0.477	12.12	0.035	0.89
6230/15C	15	0.518	13.16	0.035	0.89
6230/18C	18	0.586	14.88	0.050	1.27
6230/25C	25	0.677	17.20	0.050	1.27

Characteristic impedance: 105 ohms
Mutual capacitance: 12.5 pF/ft (41 pF/m)
Ground capacitance: 22 pF/ft (72 pF/m)



Communication and Control

300 V Individually Foil Shielded Pairs, Multipair, PVC, PVC

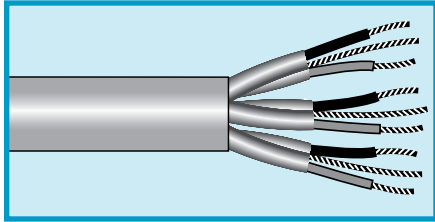

UL AWM 2919 (30 V) VW-1
UL CL2
CSA CMG FT4

Operating Temperature

- -20°C to +80°C (AWM)
- -20°C to +75°C (CM)
- -20°C to +60°C (CMG)

Conductor Color Coding

- Chart A (page 528)

Materials

- Stranded tinned copper conductors
- PVC insulation
- Individual aluminum/polyester foil shield, 25% overlap min.
Foil facing inward
- Stranded tinned copper drain wire
- PVC jacket

Availability

100 ft (30.5 m)
 500 ft (152 m)
 1000 ft (305 m)

22 AWG (0.35 mm²)

Stranding: 7/30 (7 x 0.25 mm)
 Insulation thickness: 0.016 (0.41 mm)
 22 AWG (0.35 mm²) drain wire

Part No.	Pairs	Nominal Diameter		Jacket Thickness	
		Inch	mm	Inch	mm
6052C	2	0.316	8.03	0.043	1.09
6053C	3	0.334	8.48	0.043	1.09
6054C	4	0.364	9.25	0.043	1.09
6056C	6	0.451	11.46	0.053	1.35
6059C	9	0.522	13.26	0.053	1.35
6059/11C	11	0.581	14.76	0.053	1.35
6059/15C	15	0.644	16.36	0.053	1.35
6059/19C	19	0.698	17.73	0.063	1.60
6059/27C	27	0.828	21.03	0.063	1.60

18 AWG (0.81 mm²)

Stranding: 16/30 (16 x 0.25 mm)
 Insulation thickness: 0.016 (0.41 mm)
 20 AWG (0.51 mm²) drain wire

Part No.	Pairs	Nominal Diameter		Jacket Thickness	
		Inch	mm	Inch	mm
6062C	2	0.376	9.55	0.043	1.09
6063C	3	0.418	10.62	0.053	1.35
6064C	4	0.456	11.58	0.053	1.35
6066C	6	0.541	13.74	0.053	1.35
6069C	9	0.650	16.51	0.063	1.60
6069/15C	15	0.804	20.42	0.063	1.60



Communication and Control

300 V Individually Foil Shielded Pairs, Multipair, PP, PVC

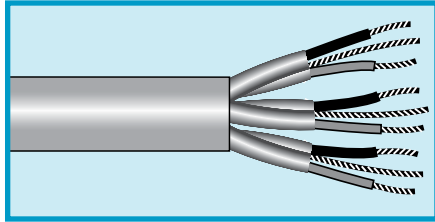

UL 2493 VW-1
UL CM, CMG
CSA CMG FT4

Operating Temperature

- -20°C to +75°C (CM)
- -20°C to +60°C (AWM)
- -20°C to +60°C (CMG)

Conductor Color Coding

- Chart A (page 528)

Materials

- Solid or stranded tinned copper conductors
- Polypropylene insulation
- Individual aluminum/polyester foil shield, 25% overlap min. Foil facing inward
- Solid or stranded tinned copper drain wire, 22 AWG (0.35 mm²), 7/30 (7 x 0.25 mm)
- Slate PVC jacket

Availability

100 ft (30.5 m)
 500 ft (152 m)
 1000 ft (305 m)

22 AWG (0.32 mm²)

Stranding: Solid
 Insulation thickness: 0.010 (0.25 mm)

Part No.	Pairs	Nominal Diameter		Jacket Thickness		UL
		Inch	mm	Inch	mm	
6000C	3	0.278	7.06	0.047	1.19	CM
6008C	15	0.492	12.50	0.047	1.19	CM

Characteristic impedance: 62 ohms
 Mutual capacitance: 25 pF/ft (82 pF/m)
 Ground capacitance: 45 pF/ft (147 pF/m)

22 AWG (0.35 mm²)

Stranding: 7/30 (7 x 0.25 mm)
 Insulation thickness: 0.010 (0.25 mm)

Part No.	Pairs	Nominal Diameter		Jacket Thickness		UL
		Inch	mm	Inch	mm	
6010C	3	0.298	7.57	0.048	1.22	CMG
6012C	6	0.378	9.60	0.048	1.22	CMG
6014C	9	0.436	11.07	0.048	1.22	CMG
6016C	11	0.483	12.27	0.048	1.22	CMG
6017C	12	0.483	12.27	0.048	1.22	CMG
6018C	15	0.565	14.35	0.063	1.60	CM
6019C	17	0.593	15.06	0.063	1.60	CM
6020C	19	0.593	15.06	0.063	1.60	CM
6022C	27	0.698	17.73	0.063	1.60	CM

Characteristic impedance: 55 ohms
 Mutual capacitance: 28 pF/ft (91.9 pF/m)
 Ground capacitance: 50 pF/ft (164 pF/m)

20 AWG (0.56 mm²)

Stranding: 7/28 (7 x 0.33 mm)
 Insulation thickness: 0.013 (0.33 mm)

Part No.	Pairs	Nominal Diameter		Jacket Thickness		UL
		Inch	mm	Inch	mm	
6032C	2	0.331	8.41	0.047	1.19	CMG
6033C	3	0.349	8.86	0.047	1.19	CMG
6036C	6	0.450	11.43	0.047	1.19	CMG
6039C	9	0.555	14.10	0.063	1.60	CMG
6042C	12	0.615	15.62	0.063	1.60	CMG

Characteristic impedance: 61 ohms
 Mutual capacitance: 25 pF/ft (82 pF/m)
 Ground capacitance: 45 pF/ft (147.6 pF/m)

18 AWG (0.81 mm²)

Stranding: 16/30 (16 x 0.25 mm)
 Insulation thickness: 0.016 (0.41 mm)

Part No.	Pairs	Nominal Diameter		Jacket Thickness		UL
		Inch	mm	Inch	mm	
6023C	3	0.406	10.31	0.047	1.19	CM
6024C	6	0.561	14.25	0.063	1.60	CM
6025C	9	0.650	16.51	0.063	1.60	CM

Characteristic impedance: 59 ohms
 Mutual capacitance: 26 pF/ft (85.3 pF/m)
 Ground capacitance: 47 pF/ft (154.2 pF/m)



Communication and Control

300 V Individually Foil Shielded Pairs, Multipair, PVC, PVC

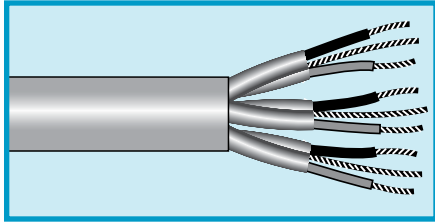

UL PLTC
UL CM
UL VW-1
CSA CMG FT4

Operating Temperature

- -20°C to +105°C (PLTC, CM)
- -20°C to +60°C (CMG)

Conductor Color Coding

- Black and red pairs, numbered

Materials

- Stranded tinned copper conductors
- PVC insulation
- Individual aluminum/polyester foil shield, 25% overlap min.
Foil facing inward
- Stranded tinned copper drain wire
- Slate PVC jacket

Availability

500 ft (152 m)
 1000 ft (305 m)

22 AWG (0.35 mm²)

Stranding: 7/30 (7 x 0.25 mm)
 Insulation thickness: 0.013 (0.33 mm)
 24 AWG (0.23 mm²) drain wire

Part No.	Pairs	Nominal Diameter		Jacket Thickness	
		Inch	mm	Inch	mm
6434	2	0.295	7.49	0.043	1.09
6435	3	0.311	7.89	0.043	1.09
6436	4	0.338	8.58	0.043	1.35
6437	6	0.420	10.66	0.053	1.35
6438	9	0.484	12.29	0.053	1.35
6439	11	0.537	13.63	0.053	1.35
6440	19	0.646	16.40	0.063	1.60
6441	51	1.020	25.90	0.075	1.91

18 AWG (0.96 mm²)

Stranding: 19/30 (19 x 0.25 mm)
 Insulation thickness: 0.016 (0.41 mm)
 20 AWG (0.56 mm²) drain wire

Part No.	Pairs	Nominal Diameter		Jacket Thickness	
		Inch	mm	Inch	mm
6442	2	0.406	10.31	0.053	1.35
6443	3	0.429	10.90	0.053	1.35
6444	4	0.468	11.89	0.053	1.35
6445	6	0.557	14.15	0.053	1.35
6446	9	0.669	16.99	0.063	1.60
6447	11	0.746	18.95	0.063	1.60
6448	15	0.829	21.06	0.063	1.60



Communication and Control

350 V Individually Foil Shielded Pairs, Multipair, PP, PE Direct Burial

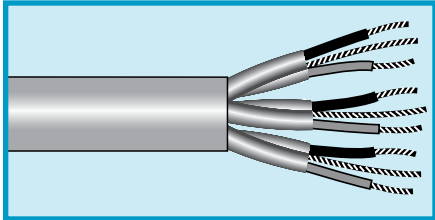

20 AWG (0.51 mm²)

Stranding: 10/30 (10 x 0.25 mm)
Insulation thickness: 0.008 (0.20 mm)

Part No.	Pairs	Nominal Diameter		Jacket Thickness	
		Inch	mm	Inch	mm
6314	3	0.291	7.39	0.040	1.02
6315	6	0.385	9.78	0.045	1.14

Characteristic impedance: 48 ohms
Mutual capacitance: 31 pF/ft (101.7 pF/m)
Ground capacitance: 56 pF/ft (183.7 pF/m)

Operating Temperature

- -20°C to +80°C

Conductor Color Coding

- Chart A (page 528)

Materials

- Stranded tinned copper conductors
- Polypropylene insulation
- Individual aluminum/polyester foil shield, 25% overlap min.
Foil facing inward
- Stranded tinned copper drain wire, 22 AWG (0.35 mm²), 7/30 (7 x 0.25 mm)
- Black polyethylene jacket

Availability

1000 ft (305 m)
500 ft (152 m)

Communication and Control

300 V Individually Foil Shielded Pairs, Multipair, PE, PVC

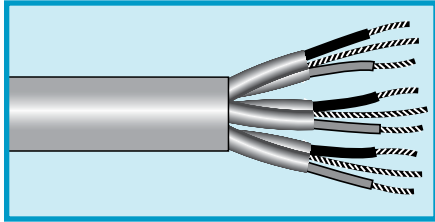

UL AWM 2919 (30 V) VW-1
UL CM
CSA CMG FT4

Operating Temperature

- -20°C to +80°C (AWM)
- -20°C to +75°C (CM)
- -20°C to +60°C (CMG)

Conductor Color Coding

- Chart A (page 528)

Materials

- Stranded tinned copper conductors
- Polyethylene insulation
- Individual aluminum/polyester foil shield, 25% overlap min.
Foil facing inward
- Stranded tinned copper drain wire equal in size to conductor
- Slate PVC jacket

Availability

100 ft (30.5 m)
 500 ft (152 m)
 1000 ft (305 m)

24 AWG (0.22 mm²)

Stranding: 7/32 (7 x 0.20 mm)
 Insulation thickness: 0.010 (0.25 mm)

Part No.	Pairs	Nominal Diameter		Jacket Thickness	
		Inch	mm	Inch	mm
6385	3	0.247	6.27	0.035	0.89
6386	6	0.317	8.05	0.035	0.89
6387	9	0.368	9.35	0.035	0.89
6388	12	0.411	10.44	0.035	0.89
6389	25	0.599	15.21	0.047	1.19

Characteristic impedance: 60 ohms
 Mutual capacitance: 25 pF/ft (82 pF/m)
 Ground capacitance: 47 pF/ft (154.2 pF/m)



Communication and Control

300 V Individually Foil Shielded Pairs, Multipair, PP, PVC

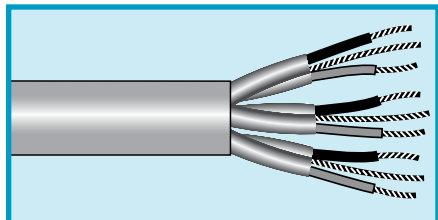

UL CMG
CSA CMG FT4

Operating Temperature

- -20°C to +75°C (CM)
- -20°C to +60°C (CMG)

Conductor Color Coding

- See tables

Materials

- Stranded tinned copper conductors
- Polypropylene insulation
- Individual aluminum/polyester foil shield, 25% overlap min. Stranded tinned copper drain wire (see tables for sizes)
- Slate PVC jacket

Availability

100 ft (30.5 m)
500 ft (152 m)
1000 ft (305 m)

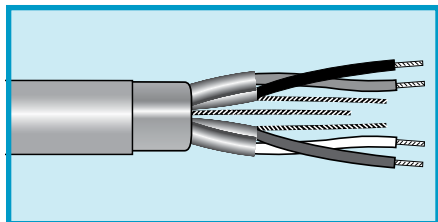

Individually Shielded Pairs

22 AWG (0.35 mm²)

Stranding: 7/30 (7 x 0.25 mm)
Insulation thickness: 0.010 (0.25 mm)
24 AWG (0.22 mm²) drain wire
Foil facing outward

Part No.	Pairs	Nominal Diameter		Jacket Thickness	
		Inch	mm	Inch	mm
2466C	2	0.170	4.32	0.020	0.51

Characteristic impedance: 60 ohms
Mutual capacitance: 25 pF/ft (82 pF/m)
Ground capacitance: 45 pF/ft (147.6 pF/m)

Color code: 1 Red-Black, 2 Green-White.

Individually Shielded Pairs, UL CM

22 AWG (0.35 mm²)

Stranding: 7/30 (7 x 0.25 mm)
Insulation thickness: 0.008 (0.20 mm)
24 AWG (0.22 mm²) drain wire
Foil facing outward

Part No.	Pairs	Nominal Diameter		Jacket Thickness	
		Inch	mm	Inch	mm
2463C	4	0.230	5.84	0.020	0.51

Characteristic impedance: 53 ohms
Mutual capacitance: 29 pF/ft (95.1 pF/m)
Ground capacitance: 52 pF/ft (170.6 pF/m)

Color code: 1 Red-Black, 2 Green-White, 3 White/Red-White/Black, 4 White/Green-White/Yellow.

Individually Shielded Pairs

20 AWG (0.56 mm²)

Stranding: 7/28 (7 x 0.32 mm)
Insulation thickness: 0.015 (0.38 mm)
22 AWG (0.35 mm²) drain wire
Foil facing inward

Part No.	Pairs	Nominal Diameter		Jacket Thickness	
		Inch	mm	Inch	mm
2467C	4	0.340	8.64	0.030	0.76

Characteristic impedance: 66 ohms
Mutual capacitance: 23 pF/ft (75.5 pF/m)
Ground capacitance: 41 pF/ft (134.5 pF/m)

Color code: 1 Red-Black, 2 Green-White, 3 White/Red-White/Black, 4 White/Green-White/Yellow.

Individually Shielded Pairs +Overall Shield, AWM 2717

22 AWG (0.35 mm²)

Stranding: 7/30 (7 x 0.25 mm)
Insulation thickness: 0.009 (0.23 mm)
22 AWG (0.35 mm²) drain wire
Foil facing inward

Part No.	Pairs	Nominal Diameter		Jacket Thickness	
		Inch	mm	Inch	mm
1243/2C	2	0.245	6.22	0.030	0.76

Characteristic impedance: 57 ohms
Mutual capacitance: 27 pF/ft (88.6 pF/m)
Ground capacitance: 49 pF/ft (160.7 pF/m)

Color code: 1 Red-Black, 2 Green-White.



Communication and Control

300 V Individually Foil Shielded Pairs and Overall Foil/Braid, Multipair, FPE, PVC, Low Capacitance Data Cable

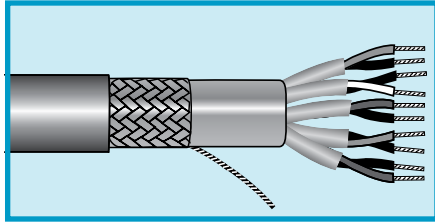

UL AWM 2493 VW-1
UL CM
CSA CM FT1

Operating Temperature

- -20°C to +75°C (CM)
- -20°C to +60°C (AWM, CMG)

Conductor Color Coding

- Chart A (page 528)
- (See table at right for Part No. 6319 and 6322)

Materials

- Stranded tinned copper conductors
- Foam polyethylene insulation
- Individual aluminum/polyester foil shield, 25% overlap min.
Foil facing inward
Stranded tinned copper drain wire, 24 AWG (0.23 mm²), 7/32 (7 x 0.20 mm)
- Overall foil + braid shielding
Aluminum/polyester foil, 25% overlap min.
Foil facing outward
Stranded tinned copper drain wire equal in size to conductor
Tinned copper braid, 65% coverage
- Slate PVC jacket

Availability

100 ft (30.5 m)
 500 ft (152 m)
 1000 ft (305 m)

24 AWG (0.22 mm²)

Stranding: 7/32 (7 x 0.20 mm)
 Insulation thickness: 0.019 (0.49 mm)

Part No.	Pairs	Nominal Diameter		Jacket Thickness	
		Inch	mm	Inch	mm
6316	2	0.349	8.86	0.048	1.22
6317	3	0.353	8.97	0.048	1.22
6318	4	0.397	10.08	0.048	1.22
6319*	5	0.430	10.92	0.048	1.22
6320	6	0.464	11.79	0.048	1.22
6321	7	0.464	11.79	0.048	1.22
6322*	8	0.499	12.67	0.048	1.22
6323	10	0.606	15.39	0.063	1.60
6324	15	0.687	17.45	0.063	1.60
6325	18	0.721	18.31	0.063	1.60
6326	25	0.901	22.89	0.085	2.16

Characteristic impedance: 100 ohms
 Mutual capacitance: 12.5 pF/ft (41 pF/m)
 Ground capacitance: 22 pF/ft (72.2 pF/m)

*Color Code

Pair No.	Color	Pair No.	Color
1	Black, Red	5	Black, Yellow
2	Black, White	6	Black, Brown
3	Black, Green	7	Black, Orange
4	Black, Blue	8	Red, White



Communication and Control

300 V Foil Shield, Multiconductor, PVC, PVC
Plenum Rated

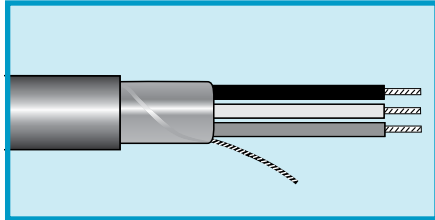

UL CL2P
UL CMP
CSA CMP FT6

Operating Temperature

- 5°C to +75°C

Conductor Color Coding

- Chart D2 (page 531)

Materials

- Stranded bare copper conductors
- Plenum-rated PVC insulation
- Foil shield
Aluminum/polyester foil shield,
25% overlap min.
Foil facing outward
- Stranded tinned copper drain
wire (see tables for size)
- Slate plenum-rated PVC jacket

Availability

500 ft (152 m)
1000 ft (305 m)

24 AWG (0.22 mm²)

Stranding: 7/32 (7 x 0.20 mm)
Insulation thickness: 0.008 (0.020 mm)
24 AWG (0.22 mm²) drain wire

Part No.	Conductors	Nominal Diameter		Jacket Thickness	
		Inch	mm	Inch	mm
58401	2	0.120	3.05	0.015	0.39
57003	3	0.120	3.05	0.015	0.39
57004	4	0.131	3.33	0.015	0.39
57006	6	0.154	3.91	0.015	0.39
57008	8	0.167	4.24	0.015	0.39
57010	10	0.194	4.93	0.015	0.39
57015	15	0.217	5.51	0.015	0.39
58110/25	25	0.262	6.65	0.015	0.39

22 AWG (0.35 mm²)

Stranding: 7/30 (7 x 0.25 mm)
Insulation thickness: 0.008 (0.020 mm)
24 AWG (0.22 mm²) drain wire

Part No.	Conductors	Nominal Diameter		Jacket Thickness	
		Inch	mm	Inch	mm
58411	2	0.126	3.20	0.015	0.39
58113	3	0.133	3.38	0.015	0.39
58114	4	0.145	3.68	0.015	0.39
58116	6	0.172	4.37	0.015	0.39
58117	7	0.172	4.37	0.015	0.39
58118	8	0.187	4.75	0.015	0.39
58119	9	0.201	5.11	0.015	0.39
58120	10	0.218	5.54	0.015	0.39
58120/12	12	0.225	5.72	0.015	0.39
58120/15	15	0.245	6.22	0.015	0.39
58120/25	25	0.314	7.98	0.017	0.43

20 AWG (0.35 mm²)

Stranding: 7/0.0121 (7 x 0.31 mm)
Insulation thickness: 0.008 (0.020 mm)
22 AWG (0.35 mm²) drain wire

Part No.	Conductors	Nominal Diameter		Jacket Thickness	
		Inch	mm	Inch	mm
58421	2	0.138	3.51	0.015	0.39
58124	4	0.160	4.06	0.015	0.39
58126	6	0.191	4.85	0.015	0.39



Communication and Control

300 V Foil Shield, Multiconductor, PVC, PVC
Plenum Rated

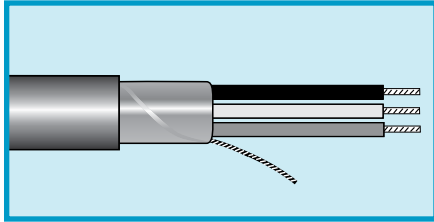

UL CL2P
UL CMP
CSA CMP FT6

Operating Temperature

- -5°C to +75°C

Conductor Color Coding

- Chart D2 (page 531)

Materials

- Stranded bare copper conductors
- Plenum-rated PVC insulation
- Foil shield
Aluminum/polyester foil shield,
25% overlap min.
Foil facing outward
- Stranded tinned copper drain wire (see tables for size)
- Slate plenum-rated PVC jacket

Availability

500 ft (152 m)
1000 ft (305 m)

18 AWG (0.82 mm²)

Stranding: 7/0.0152 (7 x 0.39 mm)
Insulation thickness: 0.009 (0.023 mm)
22 AWG (0.35 mm²) drain wire

Part No.	Conductors	Nominal Diameter		Jacket Thickness	
		Inch	mm	Inch	mm
58431	2	0.162	4.11	0.015	0.39
58133	3	0.172	4.37	0.015	0.39
58134	4	0.189	4.80	0.015	0.39
58136	6	0.227	5.77	0.015	0.39

16 AWG (1.31 mm²)

Stranding: 7/0.0192 (7 x 0.49 mm)
Insulation thickness: 0.009 (0.023 mm)
18 AWG (0.82 mm²) drain wire

Part No.	Conductors	Nominal Diameter		Jacket Thickness	
		Inch	mm	Inch	mm
58142	2	0.186	4.72	0.015	0.39
58144	4	0.218	5.54	0.015	0.39

Communication and Control

300/150 V Foil Shield, Multipair, PVC, PVC
Plenum Rated

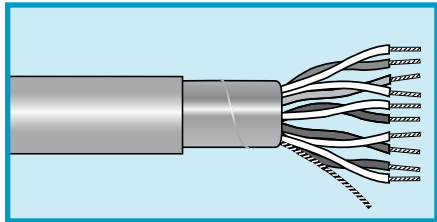

UL CL2P
UL CMP
CSA CMP FT6

Operating Temperature

- 5°C to +75°C

Conductor Color Coding

- Chart A1 (page 528)

Materials

- Stranded bare copper conductors
- Plenum-rated PVC insulation
- Foil shield
- Aluminum/polyester foil shield, 25% overlap min.
Foil facing outward
- Stranded tinned copper drain wire (see tables for size)
- Slate plenum-rated PVC jacket

Availability

500 ft (152 m)
1000 ft (305 m)

24 AWG (0.22 mm²)

Stranding: 7/32 (7 x 0.20 mm)
Insulation thickness: 0.008 (0.020 mm)
24 AWG (0.22 mm²) drain wire

Part No.	Pairs	Nominal Diameter		Jacket Thickness	
		Inch	mm	Inch	mm
57602	2	0.165	4.19	0.015	0.39
57603	3	0.175	4.45	0.015	0.39
57604	4	0.193	4.90	0.015	0.39
57605	5	0.212	5.38	0.015	0.39
57606	6	0.231	5.87	0.015	0.39

22 AWG (0.35 mm²)

Stranding: 7/30 (7 x 0.25 mm)
Insulation thickness: 0.008 (0.020 mm)
24 AWG (0.22 mm²) drain wire

Part No.	Pairs	Nominal Diameter		Jacket Thickness	
		Inch	mm	Inch	mm
58412	2	0.185	4.70	0.015	0.39
58413	3	0.197	5.00	0.015	0.39
58414	4	0.217	5.51	0.015	0.39
58415	5	0.239	6.07	0.015	0.39
58416	6	0.261	6.63	0.015	0.39
57628	8	0.285	7.24	0.015	0.39
58419	9	0.311	7.90	0.016	0.41
58420/19	19	0.418	10.62	0.018	0.46

20 AWG (0.35 mm²)

Stranding: 7/0.0121 (7 x 0.31 mm)
Insulation thickness: 0.008 (0.020 mm)
22 AWG (0.35 mm²) drain wire

Part No.	Pairs	Nominal Diameter		Jacket Thickness	
		Inch	mm	Inch	mm
57632	2	0.205	5.21	0.015	0.39
57634	4	0.240	6.10	0.015	0.39
57636	6	0.291	7.39	0.015	0.39



Communication and Control

150 V Foil Shield, Multipair, FEP, PVDF
Plenum Rated, Low- and Mid-Capacitance

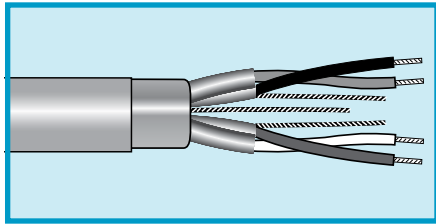

UL CL2P
UL CMP
CSA CMP FT6

Operating Temperature

- 25°C to +125°C

Conductor Color Coding

- Chart A1 (page 528)

Materials

- Stranded tinned copper conductors
- FEP insulation
- Aluminum/polyester foil shield, 25% overlap min.
Foil facing inward
- Stranded tinned copper drain wire, 24 AWG (0.22 mm²), 7/32 (7 x 0.20 mm)
- Slate PVDF jacket

Availability

500 ft (152 m)

1000 ft (305 m)*

*May contain multiple lengths

Individually Shielded Pairs

24 AWG (0.22 mm²)

Stranding: 7/32 (7 x 0.20 mm)
Insulation thickness: 0.007 (0.18 mm)

Part No.	Pairs	Nominal Diameter		Jacket Thickness	
		Inch	mm	Inch	mm
58602	2	0.164	4.17	0.009	0.23
58603	3	0.175	4.45	0.009	0.23
58604	4	0.194	4.93	0.009	0.23

Mutual capacitance: 25 pF/ft (82 pF/m)
Ground capacitance: 45 pF/ft (147.6 pF/m)

Overall Shield

24 AWG (0.22 mm²)

Stranding: 7/32 (7 x 0.20 mm)
Insulation thickness: 0.007 (0.18 mm)

Part No.	Pairs	Nominal Diameter		Jacket Thickness	
		Inch	mm	Inch	mm
58802	2	0.154	3.91	0.011	0.28
58803	3	0.163	4.14	0.011	0.28
58804	4	0.180	4.57	0.011	0.28
58806	6	0.217	5.51	0.011	0.28
58809	9	0.256	6.50	0.011	0.28
58812	12.5	0.294	7.47	0.011	0.28

Mutual capacitance: 20 pF/ft (65.6 pF/m)
Ground capacitance: 36 pF/ft (118.1 pF/m)

Overall Shield

24 AWG (0.22 mm²)

Stranding: 7/32 (7 x 0.20 mm)
Insulation thickness: 0.012 (0.30 mm)

Part No.	Pairs	Nominal Diameter		Jacket Thickness	
		Inch	mm	Inch	mm
58902	2	0.186	4.72	0.011	0.28
58903	3	0.199	5.05	0.011	0.28
58904	4	0.219	5.56	0.011	0.28
58906	6	0.266	6.76	0.011	0.28
58909	9	0.315	8.00	0.011	0.28
58912	12.5	0.367	9.32	0.011	0.28

Mutual capacitance: 12.5 pF/ft (41 pF/m)
Ground capacitance: 23 pF/ft (75.5 pF/m)



Communication and Control

150 V Foil Shield, Multipair, FEP, PVDF
Plenum Rated, Low- and Mid-Capacitance

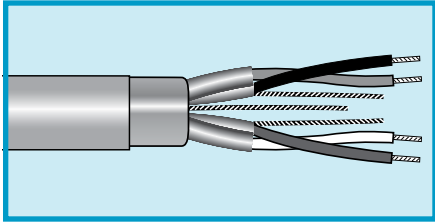

UL CL2P
UL CMP
CSA CMP FT6

Operating Temperature

- 55°C to +125°C

Conductor Color Coding

- Chart A1 (page 528)

Materials

- Stranded tinned copper conductors
- FEP insulation
- Aluminum/polyester foil shield, 25% overlap min.
Foil facing inward
- Stranded tinned copper drain wire, 24 AWG (0.22 mm²), 7/32 (7 x 0.20 mm)
- Slate PVDF jacket

Availability

500 ft (152 m)
1000 ft (305 m)*

*May contain multiple lengths

Overall Foil Shield, Individually Shielded Pairs

22 AWG (0.35 mm²)

Stranding: 7/30 (7 x 0.25 mm)
Insulation thickness: 0.007 (0.18 mm)

Part No.	Pairs	Nominal Diameter		Jacket Thickness	
		Inch	mm	Inch	mm
58612	2	0.189	4.80	0.009	0.23
58613	3	0.202	5.13	0.009	0.23
58616	6	0.272	6.91	0.009	0.23

Mutual capacitance: 29 pF/ft (95.1 pF/m)
Ground capacitance: 51 pF/ft (167.3 pF/m)

Individually Shielded Pairs, Overall Shield

18 AWG (0.82 mm²)

Stranding: 7/0.0152 (7 x 0.39 mm)
Insulation thickness: 0.007 (0.18 mm)

Part No.	Pairs	Nominal Diameter		Jacket Thickness	
		Inch	mm	Inch	mm
58632	2	0.247	6.27	0.010	0.25
58633	3	0.264	6.71	0.012	0.30

Mutual capacitance: 35 pF/ft (114.8 pF/m)
Ground capacitance: 63 pF/ft (206.7 pF/m)

Individually Shielded Pairs

16 AWG (0.35 mm²)

Stranding: 7/0.0192 (7 x 0.49 mm)
Insulation thickness: 0.007 (0.18 mm)

Part No.	Pairs	Nominal Diameter		Jacket Thickness	
		Inch	mm	Inch	mm
58642	2	0.289	7.34	0.012	0.30
58643	3	0.309	7.85	0.012	0.30

Mutual capacitance: 39 pF/ft (128 pF/m)
Ground capacitance: 69 pF/ft (226.4 pF/m)



Communication and Control

200 V Unshielded and Shielded, Multiconductor PVC, PVC Hi-Fi and Stereo Cable

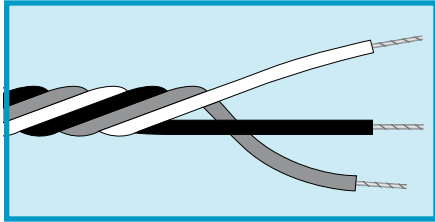

Operating Temperature

- 20°C to +80°C

Conductor Color Coding

- 1 Black, 2 Red, 3 White, 4 Green

Materials

- Stranded tinned copper conductors
- PVC insulation
- Conductors twisted in an extra tight lay

Availability

100 ft (30.5 m)
1000 ft (305 m)

Miniature Shielded Cable

Conductor Color Coding

- 1 Black, 2 Red, 3 White, 4 Green

Materials

- Stranded tinned copper conductors
- Color-coded PVC insulation
- Tinned copper braid shield, 80% coverage
- Clear PVC jacket

Availability

100 ft (30.5 m)
500 ft (152 m)
1000 ft (305 m)

32 AWG (0.03 mm²)

Stranding: 7/40 (7 x 0.08 mm)
Insulation thickness: 0.010 (0.25 mm)

Part No.	Conductors	Nominal Diameter	
		Inch	mm
1101	3	0.063	1.60
1102	4	0.072	1.83

30 AWG (0.05 mm²)

Stranding: 7/38 (7 x 0.10 mm)
Insulation thickness: 0.010 (0.25 mm)

Part No.	Conductors	Nominal Diameter	
		Inch	mm
1115	2	0.064	1.63
1116	3	0.070	1.78

28 AWG (0.09 mm²)

Stranding: 7/36 (7 x 0.13 mm)
Insulation thickness: 0.010 (0.25 mm)

Part No.	Conductors	Nominal Diameter		Jacket Thickness	
		Inch	mm	Inch	mm
1120	2	0.115	2.92	0.010	0.25
1121	3	0.120	3.05	0.010	0.25
1122	4	0.130	3.30	0.010	0.25

Communication and Control

150 V Unshielded Multiconductor PP, PVC Silver Satin Oval Telephone Cable

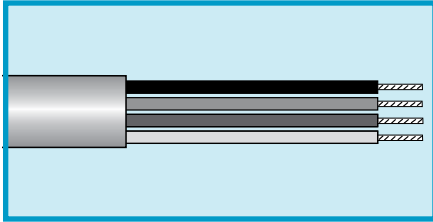

26 AWG (0.14 mm²)

Stranding: 7/34 (7 x 0.16 mm)
Insulation thickness: 0.009 (0.23 mm)

Part No.	Conductors	Nominal Outer Dimension		Jacket Thickness	
		Inch	mm	Inch	mm
1604	4	0.090 x 0.190	2.28 x 4.83	0.020	0.51
1606	6	0.090 x 0.270	2.28 x 6.85	0.024	0.61
1608	8	0.090 x 0.350	2.28 x 8.89	0.024	0.61

Temperature Rating

- -20°C to +60°C

Conductor Color Coding

- See table

Materials

- Stranded bare copper conductors
- Polypropylene insulation
- Silver PVC jacket

Conductor Color Coding

Conductor No.	1604	1606	1608
1	Black	White	Slate
2	Red	Black	Orange
3	Green	Red	Black
4	Yellow	Green	Red
5		Yellow	Green
6		Blue	Yellow
7			Blue
8			Brown

Availability

328 ft (100 m), box
1000 ft (305 m), box

Communication and Control

300 V Individually Foil Shielded Pairs or Overall Foil Shielded, Multipair, FPP, PVC

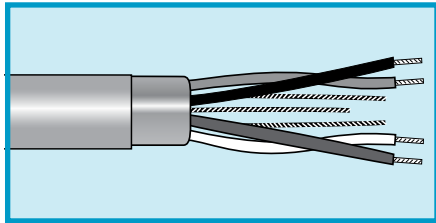
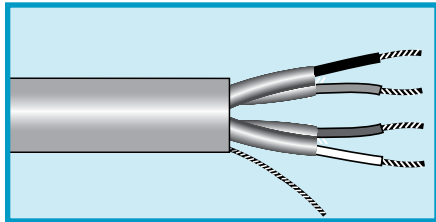

Individually Foil Shielded Pairs

24 AWG (0.23 mm²)

Stranding: 7/32 (7 x 0.20 mm)
Insulation thickness: 0.023 (0.58)

Part No.	Pairs	Nominal Diameter		Jacket Thickness		AWM
		Inch	mm	Inch	mm	
6073C	3	0.374	9.50	0.048	1.22	2493
6076C	6	0.483	12.27	0.048	1.22	2493
6079C	9	0.597	15.16	0.065	1.65	2493
6079/11C	11	0.643	16.33	0.065	1.65	2493
6079/12C	12	0.663	16.84	0.065	1.65	2493
6079/15C	15	0.719	18.26	0.065	1.65	2493
6079/27C	27	0.962	24.43	0.087	2.21	2490

Characteristic impedance: 115 ohms
Mutual capacitance: 12 pF/ft (41 pF/m)

Overall Foil Shield

22 AWG (0.32 mm²)

Stranding: Solid
Insulation thickness: 0.023 (0.58)

Part No.	Pairs	Nominal Diameter		Jacket Thickness		AWM
		Inch	mm	Inch	mm	
6072C*	2	0.42	9.50	0.035	0.89	2668

Characteristic impedance: 150 ohms
Mutual capacitance: 8.8 pF/ft (28.9 pF/m)

*Black jacket.

UL AWM 2490, 2493, 2668
VW-1
UL CM
CSA CMG FT4

Operating Temperature

- -20°C to +75°C (CM)
- -20°C to +60 (AWM, CMG)

Conductor Color Coding

- Chart K (page 529)

Materials

- Solid or stranded tinned copper conductors
- Foam polypropylene insulation
- Individual aluminum/polyester foil shield, 25% overlap min.
Foil facing inward
- Stranded tinned copper drain wire, 24 AWG (0.23 mm²), 7/32 (7 x 0.20 mm)
- Slate PVC jacket (unless otherwise noted)

Availability

100 ft (30.5 m)
500 ft (152 m)
1000 ft (305 m)



Communication and Control

300 V Unshielded, Flat Cable, 0.050 (1.27 mm) Centerline

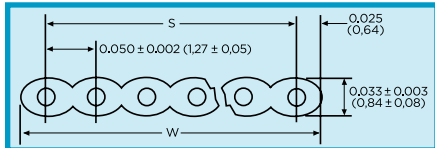
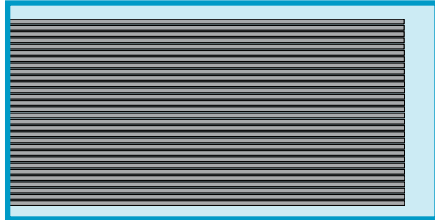

UL AWM 2651, 20932 VW-1

Operating Temperature

- 20°C to +105°C

Materials

- Stranded tinned copper conductors
- Extruded PVC insulation (slate cable)
- Thermally bonded PVC with clear PVC covering (color-coded cable)

Color

- AWM 2651: slate cable, with red polarity stripe on leading edge
- AWM 20932: color-coded cable: brown, red, orange, yellow, green, blue, violet, slate, white, black . . . repeats

Electrical Characteristics

- Capacitance: 14 pF/ft (45.9 pF/m) nom. at 1 MHz
- Propagation delay: 1.4 ns/ft (4.6 ns/m) @ 0.18 ns risetime
- Impedance: 105 ohms (G-S-G configuration)
- Near-end crosstalk: 3.2%
- Far-end crosstalk: 11.5%
- Crosstalk measured on adjacent lines, 1 ns risetime, 10 ft (3.05 m) length

Availability

100 ft (30.5 m)

May contain multiple lengths

28 AWG (0.09 mm ²)							
Stranding: 7/36 (7 x 0.13 mm)							
Insulation thickness: 0.010 (0.25 mm)							
Part No.		Conductors	Width (W)		Span (S)		
Slate (AWM 2651)	Color Coded (AWM 20932)		Inch	mm	Inch	mm	
3580/9	3583/9	9	0.45	11.43	0.40	10.16	
3580/10	3583/10	10	0.50	12.70	0.45	11.43	
3580/14	3583/14	14	0.70	17.78	0.65	16.51	
3580/15	3583/15	15	0.75	19.05	0.70	17.78	
3580/16	3583/16	16	0.80	20.32	0.75	19.05	
3580/20	3583/20	20	1.00	25.40	0.95	24.13	
3580/24	3583/24	24	1.20	30.48	1.15	29.21	
3580/25	3583/25	25	1.25	31.75	1.20	30.48	
3580/26	3583/26	26	1.30	33.02	1.25	31.75	
3580/34	3583/34	34	1.70	43.18	1.65	41.91	
3580/37	3583/37	37	1.85	46.99	1.80	45.72	
3580/40	3583/40	40	2.00	50.80	1.95	49.53	
3580/50	3583/50	50	2.50	63.50	2.45	62.23	
3580/60	3583/60	60	3.00	76.20	2.95	74.93	
3580/64	3583/64	64	3.20	81.28	3.15	80.01	



Communication and Control

300 V Foil + Braid Shield, Round to Flat
Flat Cable, 0.050 (1.27 mm) Centerline

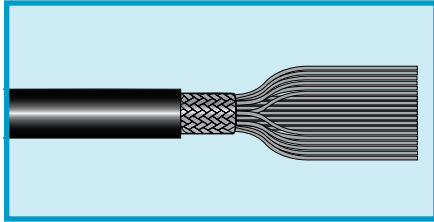

UL AWM 20381 (300 V)
UL CL2 (150 V)

Operating Temperature

- -20°C to +105°C

Materials

- Stranded tinned copper conductors
- PVC insulation
- Foil + braid shield
Aluminum/polyester
Tinned copper braid
(90% coverage)
- Black PVC jacket, 0.030
(0.08 mm) thick

Configuration

- Flat cable termination area is 0.75 (19 mm) long and occurs every 1.5 (38 mm)

Electrical Characteristics

- Capacitance: 24 pF/ft (78.7 pF/m) nom at 1 MHz
- Impedance: 70 ohms

Availability

100 ft (30.5 m)

May contain multiple lengths

28 AWG (0.09 mm²)

Stranding: 7/36 (7 x 0.13 mm)
Insulation thickness: 0.010 (0.25 mm)

Part No.	Conductors	Nominal Diameter		Nominal Width	
		Inch	mm	Inch	mm
3585/25	25	0.34	8.64	1.20	30.48
3585/26	26	0.35	8.89	1.65	41.91
3585/40	40	0.40	10.20	1.95	49.53
3585/50	50	0.46	11.70	2.45	62.23



Communication and Control

150 V, Jacketed, Foil Shield, Flat Cable, 0.050 (1.27 mm) Centerline

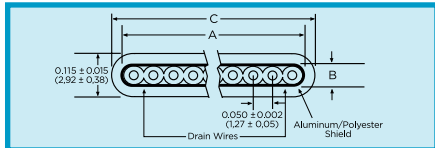
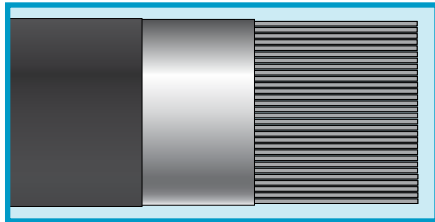

28 AWG (0.09 mm²)

Stranding: 7/36 (7 x 0.13 mm)
Insulation thickness: 0.010 (0.25 mm)

Part No.	Conductors	Nom. Core Width (A)		Nom. Jacket Width (C)	
		Inch	mm	Inch	mm
3590/10	10	0.50	12.70	0.57	14.48
3590/14	14	0.70	17.78	0.77	19.56
3590/16	16	0.80	20.32	0.87	22.10
3590/26	26	1.30	33.02	1.37	34.80

UL AWM 2912
UL Type CL2

Operating Temperature

- -20°C to +105°C

Materials

- Stranded tinned copper conductors
- Extruded slate PVC insulation with red polarity stripe
- Aluminum/polyester/aluminum foil shield
- Two 28 AWG (0.09 mm²) stranded tinned copper drain wires
- Slate PVC jacket, 0.030 (0.08 mm) thick

Electrical Characteristics

- Capacitance: 20 pF/ft (65.6 pF/m) nom. at 1 MHz
- Propagation delay: 1.45 ns/ft (4.8 ns/m) at 0.18 ns risetime
- Impedance: 70 ohms
- Near-end crosstalk: 5.5%
- Far-end crosstalk: 1.6%
- Crosstalk measured on adjacent lines, 3.5 ns risetime

Availability

100 ft (30.5 m)

May contain multiple lengths



Communication and Control

150 V Unshielded, Flat Cable, 0.025 (0.64 mm) Centerline

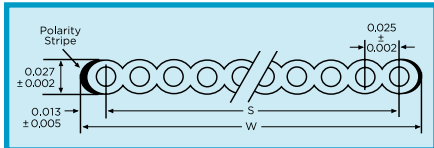
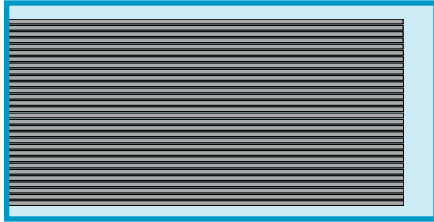

30 AWG (0.05 mm ²)					
Stranding: Solid Insulation thickness: 0.013 (0.33 mm)					
Part No.	Conductors	Width (W)		Span (S)	
		Inch	mm	Inch	mm
3582/26	26	0.65	16.51	0.625	15.88
3582/40	40	1.00	25.40	0.975	24.76
3582/50	50	1.25	31.75	1.225	31.15
3582/60	60	1.50	38.10	1.475	37.46

UL AWM 2678 VW-1

Operating Temperature

- -20°C to +105°C

Color

- Slate, with red polarity stripe on leading edge

Materials

- Solid bare copper conductors
- PVC insulation

Electrical Characteristics

- Capacitance:
 - 24.9 pF/ft (82 pF/m) nom. (G-S-G) at 1 kHz
 - 14.3 pF/ft (47 pF/m) nom. (G-S) at 1 kHz
- Propagation delay: 1.52 ns/ft (4.9 ns/m)
- Impedance:
 - 78 ohms (G-S-G single-ended configuration)
 - 131 ohms nom. (G-S differential configuration)
- Skew: 0.036 ns/ft (0.12 ns/m) max

Availability

100 ft (30.5 m)

May contain multiple lengths



Make AlphaWire.com your destination for all your cabling needs!

Language English

AlphaWire

1-800-52-ALPHA

Search GO!

Advanced Search

Products Innovative Solutions Online Tools Engineer's Room Regulations & Compliance News Site Support About AlphaWire

欢迎来到
Explore the new Chinese version of our website!

Custom Made Simple
See how fast and easy custom cable is.

Master the Possibilities
Check out the new Alpha Wire Master Catalog.

Your Cable, Your Way
Online Cable Design Center makes custom easy.
Configure and specify a custom cable quickly and easily.
Then get it delivered fast!

LEARN MORE

CUSTOM FOR YOU MADE

New Products at AlphaWire

Series XM LEARN MORE

A Tougher Cable for Continuous Flex Control Applications

Series XM Flexible Control Cable is the ideal choice for medium-to-high-flex applications. Featuring a premium-grade PVC jacket, Series XM offers a durable, oil-resistant construction that prevents contamination from hazardous fluids and protects against abrasion. Plus, its optimum flexibility and performance allows it to support a variety of industrial applications, including:

- High-speed pick-and-place robotic systems
- Automated material handling equipment
- Conveyors and transfer shuttles
- Flex track installations

Available shielded or unshielded in a variety of gauge sizes, jacket colors, and conductor counts.

Series XM Product Breakdown:

- Meets NFPA Standard 79 for industrial machinery
- Stranded conductors for better flexibility

News View Archive

4.1.11 Alpha Wire Launches Chinese-language Website

Alpha Wire has launched a Chinese-language version of its website designed to make AlphaWire.com available to an increasingly diversified customer base.

Subscribe to our Newsletter

SUBSCRIBE

Easy to use, full of information, and designed to make the selection of wire, cable, tubing, and wire management fast and easy—the Alpha Wire website is the only source you need.

- Search products by parameters
- View complete product listing
- Download specs
- Read white papers written by our industry experts
- Request a sample (or two!)
- Learn about our market-specific solution sets
- Download literature
- Look around our “Engineer’s Room”
- Build your own cable with our powerful Cable Design Center™

{ CONFESSION }

We've taken a shine to working down on the farm

(Our Solar Solution Set is a 24-hour per day workhorse)



Proven Performance, Superior Support

Alpha Wire's solar cables and photovoltaic wire are proven throughout the industry. Better still, we offer the fastest delivery so you can order what you need from our large in-stock inventory today and receive it tomorrow. To find the ideal solar cable and wire for your application, and to download our new Solar Power brochure, visit www.alphawire.com.

A Full Range for Power and Control

Solar Power Solution Set

- Photovoltaic wire
- Multiconductor solar cable
- Series M and Series P control cables
- Solid bus bar wires
- FIT® heat-shrink tubing
- Slit-loom and PVC flex tubing

Typical Applications

- Panel monitoring and control
- Panel to junction box
- Panel to collector
- Collector to inverter
- Grounding
- Motor supply

For reliable, high-performance solar farms, Alpha Wire's Solar Solution Set helps engineers and installers create reliable, durable solar systems. Our solar cables and photovoltaic wire are designed for the harsh environments of solar energy applications—the hot and cold of climate extremes, ozone and UV radiation, moisture, oil, and direct burial. Our specially formulated PVC jackets provide years of reliable service by withstanding the potential environments without failing or degrading.

Regardless of your panel-to-grid needs, we have the product to satisfy it. With wire and cable in a range of gauges and conductor counts, Alpha has the solar solution. Alpha also has the accessories, from flexible conduit to heat-shrink tubing, to help you manage the system for faster installation, easier maintenance, and reliable operation.



AlphaWire

Cables you trust. Service you deserve.

Toll Free: 1-800-52 ALPHA | www.alphawire.com

C A B L E | W I R E | A C C E S S O R I E S

Hook-Up Wire



Hook-Up Wire



The broad range of hook-up wire from Alpha means you will find the product exactly suited to your application—whether it's as straightforward as a control cabinet in a protected environment or as specialized as a machine tool on the factory floor, a high-temperature oven, or off-road construction equipment.

Our hook-up wire is available in a variety of insulations to meet your needs for temperature, ability to withstand wear and abrasion, electrical performance, or resistance to oil, solvents, and chemicals.

- **Stranded and solid copper conductors, bare or tinned, with other platings available for special application needs**
- **Broad range of insulations**
- **Color-coded insulation for easy circuit identification**
- **UL, CSA, and Mil-spec compliance**
- **Convenient put-ups as short as 100 feet**
- **Excellent uniformity and low-fray design for easy handling, stripping, and termination**

Choice of Insulations to Meet Temperature Range and Mechanical and Environmental Requirements

Insulation	Material	Temperature Range	Features
PVC	Polyvinyl chloride	-55°C to +105°C	General-purpose insulation Good abrasion resistance Excellent flame resistance
XL-PVC	Cross-linked PVC	-55°C to +105°C	Better abrasion and cut-through resistance than standard PVC Improved temperature and solder iron resistance over standard PVC Used in high-density wiring
mPPE	Modified polyphenylene ether	-40°C to +105°C	Excellent recyclability Excellent abrasion and cut-through resistance Superior dielectric properties for thinner walls than PVC—allows wires 45% smaller in diameter and 40% light in weight
PTFE	Polytetrafluoroethylene	-55°C to +200°C	High temperature Chemically inert: excellent chemical and solvent resistance Excellent electrical properties
XLPE	Cross-linked polyethylene	-55°C to +125°C	Higher temperature rating than PVC
Silicone	Silicone	-40°C to +150°C	High-voltage material Excellent flexibility Excellent dielectric strength and resistance to radiation, corona, and ozone
PDVF	Polyvinylidene fluoride	-40°C to +125°C	Widely used in wire wrap applications
ETFE	Ethylene tetrafluoroethylene	-70°C to +150°C	
TGGT	Teflon glass glass Teflon	+250°C	High-temperature applications Chemically inert: excellent chemical and solvent resistance Moisture resistant Withstands mechanical abuse and repeated flexing
MG	Mica glass	+450°C	High-temperature applications, such as heat-treating furnaces, kilns, and food service equipment Excellent thermal stability

Voltage	Insulation	Wire Range (AWG)		Approvals		Temperature Range	
		Stranded	Solid	UL	CSA		
UL/CSA							
150	XL-PVC	26 - 16	—	AWM I A/B FT1		-55°C to +105°C	
				AWM 1429		-55°C to +80°C	
	XLPE	22 - 18	—	AWM 3265	I A/B FT1	-55°C to +125°C	
300	PVC	30 - 16	24 - 16	AWM 1569		-40°C to +105°C	
				AWM 1007		-40°C to +80°C	
			TR-64		-40°C to +90°C		
	SR-PVC	30 - 16	—	AWM 1061	I A/B FT1	-10°C to +80°C	
	XL-PVC	26 - 16	—	AWM 1430	REW XL-PVC	-55°C to +105°C	
	XLPE	22 - 18	—	AWM 3266	CL 1252 XLPE	-55°C to +125°C	
	XLPE	22 - 16	—	AWM 3199	CL1054	-55°C to +125°C	
	PTFE	24 - 8	—	AWM 1180		-60°C to +200°C	
600	PVC	24 - 10	26 - 10	AWM 1015, 1230 MTW, THW, TW		TEW-105	-20°C to +105°C
		8 - 4/0	—	AWM 1242, 1284			-20°C to +105°C
	mPPE	28 - 10	18 - 14	AWM 11028	I A/B FT-1	-40°C to +105°C	
	XLPE	18 - 10	—	AWM 3271	CL 1251 XLPE	-55°C to +125°C	
	XLPE	20 - 2/0	—	AWM 3173, 3195, 3196, 3300 SIS Rated			-55°C to +125°C
	ETFE	24 - 4	—	SAE AS22759/16			-55°C to +150°C
	PTFE	26 - 8	—	SAE AS22759/11			-55°C to +200°C
	Silicone	22 - 4/0	—	AWM 3212, 3213, 3214	AWM I A/B	-40°C to +150°C	
10,000+	Silicone	22 - 2	—	AWM 3239		-40°C to +150°C	
Military							
250	PTFE	32 - 22	30 - 26	MIL-DTL-16878/6 (Type ET)		-60°C to +200°C	
600	XL-PVC	26 - 16	—	MIL-DTL-16878/1 (Type B)		-55°C to +105°C	
	PVC	32 - 14	—	MIL-DTL-16878/1 (Type B)		-55°C to +105°C	
	PVC	14 - 8	—	MIL-W-76 Type HW		-20°C to +80°C	
	PTFE	30 - 10	26 - 18	MIL-DTL-16878/4 (Type E)		-60°C to +200°C	
1000	PVC	24 - 12	24 - 18	MIL-DTL-16878/2 (Type C)		-40°C to +80°C	
	XLPE	22 - 18	—	MIL-DTL-16878/2 (Type C)		-55°C to +105°C	
	PTFE	24 - 8	—	MIL-DTL-16878/5 (Type EE)		-60°C to +200°C	
3000	XLPE	18 - 10	—	MIL-DTL-16878/1 (Type D)		-55°C to +105°C	
Solar							
1000/2000	XLPE/PVC	14 - 2	—	UL 4703 PV Wire	RW-90	-40°C to +90°C	
600/1000	LSZH/LSZH	14 - 2	—	UL 4703 PV Wire TUV 2 PFG 1169	—	-40°C to +90°C	
Wire Wrap							
	PVDF	—	30 - 24	AWM 1422, 1423		-40°C to +125°C	
	ETFE	—	30 - 24	AWM 1516, 1523		-70°C to +150°C	
Ribbon Cable: 5 to 30 Conductors							
150/300	PVC	26 - 22	—	AWM 2713, 2555		-55°C to +80°C	
600/1000	PVC	26 - 22	—	MIL-DTL-16878/1 and /2 (Types B & C)		-55°C to +105°C	

Hook-Up Wire

300 V, PVC

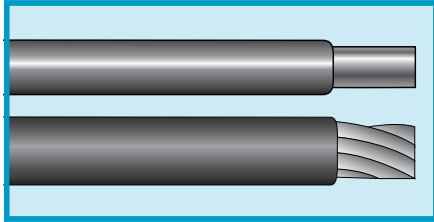

**UL AWM 1007, 1581, 1569
VW-1
CSA AWM I A/B FT1
CSA TR-64 FT1**

Operating Temperature

- -40°C to +105°C (AWM 1569, CSA AWM)
- -40°C to +90°C (CSA TR-64)
- -40°C to +80°C (AWM 1007, 1581)

Materials

- Stranded or solid tinned copper conductor
- PVC insulation

Availability

100 ft (30.5 m)
1000 ft (305 m)

Part No.	Wire Size		Stranding		Insulation Thickness		Nominal Diameter		Colors
	AWG	mm ²	AWG	mm	Inch	mm	Inch	mm	
3047	30	0.06	7/38	7 x 0.10	0.016	0.41	0.044	1.12	Z1, 1 - 10
3048	28	0.09	7/36	7 x 0.13	0.016	0.41	0.047	1.19	Z1, 1 - 10
3049	26	0.14	7/34	7 x 0.16	0.016	0.41	0.051	1.30	Z1, 1 - 10
3050/1	24	0.20	Solid	1 x 0.51	0.016	0.41	0.052	1.32	Z1, 1 - 10
3050	24	0.23	7/32	7 x 0.20	0.016	0.41	0.056	1.42	Z1, 1 - 19, 28, 30
892407T[†]	24	0.23	7/32	7 x 0.20	0.016	0.41	0.056	1.42	Z2, 0 - 9
892419[†]	24	0.24	19/36	19 x 0.13	0.016	0.41	0.057	1.45	Z2, 0 - 9
3051/1	22	0.32	Solid	1 x 0.64	0.016	0.41	0.057	1.45	Z1, 1 - 10
3051	22	0.35	7/30	7 x 0.25	0.016	0.41	0.062	1.57	Z1, 1 - 19, 28, 30
892207T[†]	22	0.35	7/30	7 x 0.25	0.016	0.41	0.062	1.57	Z2, 0 - 9
892219[†]	22	0.38	19/34	19 x 0.16	0.016	0.41	0.064	1.63	Z2, 0 - 9
3053	20	0.51	10/30	10 x 0.25	0.016	0.41	0.069	1.75	Z1, 1 - 19, 28, 30
892010T[†]	20	0.51	10/30	10 x 0.25	0.016	0.41	0.069	1.75	Z2, 0 - 9
3053/1	20	0.52	Solid	1 x 0.81	0.016	0.41	0.064	1.63	Z1, 1 - 10
892007[†]	20	0.56	7/28	7 x 0.32	0.016	0.41	0.070	1.78	Z2, 0 - 9
892019[†]	20	0.62	19/32	19 x 0.20	0.016	0.41	0.072	1.83	Z2, 0 - 9
3055	18	0.81	16/30	16 x 0.25	0.016	0.41	0.079	2.01	Z1, 1 - 19, 28, 30
891816T[†]	18	0.81	16/30	16 x 0.25	0.016	0.41	0.079	2.01	Z2, 0 - 9
3055/1	18	0.82	Solid	1 x 1.02	0.016	0.41	0.072	1.83	Z1, 1 - 10
891819[†]	18	0.96	19/30	19 x 0.25	0.016	0.41	0.082	2.08	Z2, 0 - 9
3057/1	16	1.31	Solid	1 x 1.29	0.016	0.41	0.083	2.11	Z1, 1 - 10
3057	16	1.32	26/30	26 x 0.25	0.016	0.41	0.092	2.34	Z1, 1 - 19, 28, 30
891441[†]	14	2.08	41/30	41 x 0.25	0.016	0.41	0.106	2.69	Z2, 0 - 9
891265*[†]	12	3.30	65/30	65 x 0.25	0.016	0.41	0.125	3.18	Z2, 0 - 9
891000*[†]	10	5.32	105/30	105 x 0.25	0.016	0.41	0.150	3.81	Z2, 0 - 9

*UL AWM 1581 and 1569. All others UL AWM 1007 and 1569.

[†]CSA AWM I A/B FT-1.

"T" indicates topcoat conductors.

Insulation Colors Z1

1 White	5 Yellow	9 Slate	13 White/Green	17 White/Orange	29 Yellow/Green
2 Black	6 Blue	10 Violet	14 White/Yellow	18 White/Slate	30 Pink
3 Red	7 Brown	11 White/Black	15 White/Blue	19 White/Violet	
4 Green	8 Orange	12 White/Red	16 White/Brown	28 Green/Yellow	

Insulation Colors Z2

0 Black	4 Yellow	8 Slate
1 Brown	5 Green	9 White
2 Red	6 Blue	
3 Orange	7 Violet	

These wires also available in 500 ft (152 m) put-ups.

Hook-Up Wire

300 V, Semirigid PVC

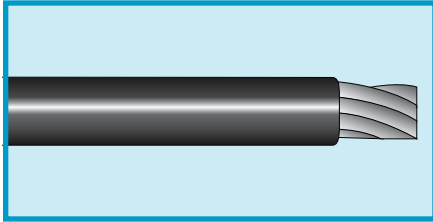

**UL AWM 1061 VW-1
CSA AWM I A/B FT1**

Operating Temperature

- -10°C to +80°C

Materials

- Stranded or solid tinned copper conductor
- Semirigid PVC insulation

Availability

100 ft (30.5 m)
1000 ft (305 m)

Part No.	Wire Size		Stranding		Insulation Thickness		Nominal Diameter		Colors
	AWG	mm ²	AWG	mm	Inch	mm	Inch	mm	
422807	28	0.09	7/36	7 x 0.13	0.010	0.25	0.035	0.89	Z2
422801	28	0.08	Solid	1 x 0.32	0.010	0.25	0.033	0.84	Z2
422607	26	0.14	7/34	7 x 0.16	0.010	0.25	0.039	0.99	Z2
422601	26	0.13	Solid	1 x 0.40	0.010	0.25	0.036	0.91	Z2
3250	24	0.23	7/32	7 x 0.20	0.010	0.25	0.044	1.12	Z1
3251	22	0.35	7/30	7 x 0.25	0.010	0.25	0.050	1.27	Z1
422010	20	0.51	10/30	10 x 0.25	0.010	0.25	0.057	1.45	Z2
3252	20	0.56	7/28	7 x 0.32	0.010	0.25	0.058	1.47	Z1
422001	20	0.52	Solid	1 x 0.81	0.010	0.25	0.052	1.32	Z2
421816	18	0.81	16/30	16 x 0.25	0.010	0.25	0.067	1.70	Z2
3253	18	0.90	7/26	7 x 0.40	0.010	0.25	0.068	1.73	Z1
421626	16	1.32	26/30	26 x 0.25	0.010	0.25	0.080	2.03	Z2
3254	16	1.43	7/24	7 x 0.51	0.010	0.25	0.080	2.03	Z1

Insulation Colors Z1

1 White	5 Yellow	9 Slate
2 Black	6 Blue	10 Violet
3 Red	7 Brown	
4 Green	8 Orange	

Insulation Colors Z2

0 Black	4 Yellow	8 Slate
1 Brown	5 Green	9 White
2 Red	6 Blue	
3 Orange	7 Violet	

These wires also available in 500 ft (152 m) put-ups.

Hook-Up Wire

600 V, PVC

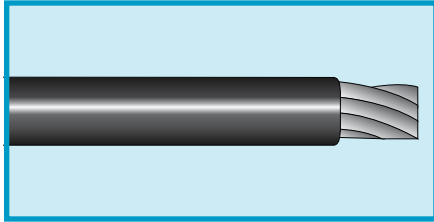

**UL AWM 1015, 1028, 1230,
1231, 1232, 1283, 1284 VW-1
UL MTW, TW (14 to 8 AWG),
THW (6 to 1/0 AWG)
CSA AWM I A/B FT1 and
TEW-105**

Operating Temperature

- -40°C to +105°C (AWM, TEW)
- -40°C to +90°C (MTW)
- -40°C to +75°C (THW)
- -40°C to +60°C (TW)

Materials

- Stranded bare copper conductor
- PVC insulation

Availability

100 ft (30.5 m)
1000 ft (305 m)

Part No.	Wire Size		Stranding		Insulation Thickness		Nominal Diameter		UL Style
	AWG	mm ²	AWG	mm	Inch	mm	Inch	mm	
461816	18	0.81	16/30	16 x 0.25	0.032	0.81	0.111	2.82	1015, 1230
461626	16	1.32	26/30	26 x 0.25	0.032	0.81	0.124	3.15	1015, 1230
461419	14	2.07	19/0.0147	19 x 0.37	0.032	0.81	0.138	3.51	1015, 1230
461219	12	3.29	19/0.0185	19 x 0.47	0.032	0.81	0.157	3.99	1015, 1230
461265	12	3.29	65/0.010	65 x 0.25	0.031	0.79	0.153	3.89	1015, 1230
461019	10	5.26	19/0.0234	19 x 0.59	0.032	0.81	0.181	4.60	1015, 1230
460819	8	8.38	19/0.0295	19 x 0.75	0.047	1.19	0.242	6.15	1028, 1231
460619	6	13.32	19/0.0372	19 x 0.94	0.063	1.59	0.311	7.90	1283, 1232
460419	4	21.09	19/0.0469	19 x 1.19	0.063	1.59	0.360	9.14	1283, 1232
460219	2	33.63	19/0.0591	19 x 1.50	0.063	1.59	0.421	10.69	1283, 1232
460001	1/0	53.39	19/0.0745	19 x 1.89	0.078	1.98	0.529	13.44	1284, 1232

Insulation Colors

White	Yellow	Slate
Black	Blue	Violet
Red	Brown	
Green	Orange	

Hook-Up Wire

600 V, PVC

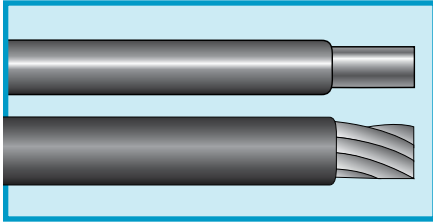

**UL AWM 1015, 1028, 1230,
1231, 1232, 1283, 1284 VW-1**
UL MTW (22 to 4/0 AWG)
UL THW (6 to 1/0 AWG)
**CSA AWM I A/B FT1 and
TEW 105**

- -20°C to +75°C (THW)
- -20°C to +60°C (TW)

Materials

- Stranded or solid tinned copper conductor
- PVC insulation

Operating Temperature

- -20°C to +105°C (AWM, TEW)
- -20°C to +90°C (MTW)

Availability

- 100 ft (30.5 m)
- 1000 ft (305 m)

Part No.	Wire Size		Stranding		Insulation Thickness			Nominal Diameter		UL Style	Colors
	AWG	mm ²	AWG	mm	Inch	mm	Inch	mm			
782607*	26	0.14	7/34	7 x 0.16	0.032	0.81	0.083	2.11	1015, 1230	Z2, 0 - 9	
782401*	24	0.20	Solid	1 x 0.51	0.032	0.81	0.084	2.13	1015, 1230	Z2, 0 - 9	
3070*	24	0.23	7/32	7 x 0.20	0.032	0.81	0.088	2.24	1015	Z1, 1 - 10, 28	
782201	22	0.32	Solid	1 x 0.64	0.032	0.81	0.089	2.26	1015, 1230	Z2, 0 - 9	
782207T	22	0.35	7/30	7 x 0.25	0.032	0.81	0.094	2.39	1015, 1230	Z2, 0 - 9	
3071	22	0.35	7/30	7 x 0.25	0.032	0.81	0.094	2.39	1015	Z1, 1 - 10, 28, 29	
782010T	20	0.51	10/30	10 x 0.25	0.032	0.81	0.101	2.57	1015, 1230	Z2, 0 - 9	
3073	20	0.51	10/30	10 x 0.25	0.032	0.81	0.101	2.57	1015	Z1, 1 - 10, 28	
782001	20	0.52	Solid	1 x 0.81	0.032	0.81	0.096	2.44	1015, 1230	Z2, 0 - 9	
781816T	18	0.81	16/30	16 x 0.25	0.032	0.81	0.111	2.82	1015, 1230	Z2, 0 - 9	
3075	18	0.81	16/30	16 x 0.25	0.032	0.81	0.111	2.82	1015	Z1, 1 - 10, 28, 29	
781801	18	0.82	Solid	1 x 1.02	0.032	0.81	0.104	2.64	1015, 1230	Z2, 0 - 9	
781601	16	1.31	Solid	1 x 1.29	0.032	0.81	0.115	2.92	1015, 1230	Z2, 0 - 9	
3077	16	1.32	26/30	26 x 0.25	0.032	0.81	0.124	3.15	1015	Z1, 1 - 10, 28, 29	
781401	14	2.08	Solid	1 x 1.63	0.032	0.81	0.128	3.25	1015, 1230	Z2, 0 - 9	
3079	14	2.08	41/30	41 x 0.25	0.032	0.81	0.138	3.51	1015	Z1, 1 - 10, 28, 29	
3080	12	3.29	65/30	65 x 0.25	0.032	0.81	0.157	3.99	1015	Z1, 1 - 4	
781201	12	3.31	Solid	1 x 2.06	0.032	0.81	0.145	3.68	1015, 1230	Z2, 0 - 9	
781001	10	5.26	Solid	1 x 2.59	0.032	0.81	0.166	4.22	1015, 1230	Z2, 0 - 9	
3081	10	5.32	105/30	105 x 0.25	0.032	0.81	0.184	4.67	1015	Z1, 1 - 4	
788133	8	8.61	133/29	133 x 0.29	0.047	1.19	0.263	6.68	1028, 1231	Z2, 0 - 9	
786133	6	13.57	133/27	133 x 0.36	0.063	1.60	0.336	8.53	1283, 1232	Z2, 0 - 9	
784133	4	21.55	133/25	133 x 0.45	0.063	1.60	0.395	10.03	1283, 1232	Z2, 0 - 9	
782665	2	33.72	665/30	665 x 0.25	0.063	1.60	0.461	11.71	1283, 1232	Z2, 0 - 9	
782133	2	34.45	133/23	133 x 0.57	0.063	1.60	0.465	11.81	1283, 1232	Z2, 0 - 9	
781259	1	41.96	259/25	259 x 0.45	0.082	2.08	0.540	13.72	1284, 1232	Z2, 0 - 9	
781836	1	42.39	836/30	836 x 0.25	0.082	2.08	0.547	13.89	1284, 1232	Z2, 0 - 9	
780001	1/0	52.98	1045/30	1045 x 0.25	0.082	2.08	0.592	15.04	1284, 1232	Z2, 0 - 9	
780002	2/0	67.43	1330/30	1330 x 0.25	0.082	2.08	0.647	16.43	1284, 1232	Z2, 0 - 9	
780003	3/0	84.47	1666/30	1666 x 0.25	0.082	2.08	0.768	19.51	1284, 1232	Z2, 0 - 9	
780004	4/0	106.93	2109/30	2109 x 0.25	0.082	2.08	0.754	19.15	1284, 1232	Z2, 0 - 9	

T indicates top coat conductors.

*Not MTW

Insulation Colors Z1

1 White	5 Yellow	9 Slate
2 Black	6 Blue	10 Violet
3 Red	7 Brown	28 Green/Yellow
4 Green	8 Orange	29 Yellow/Green

Insulation Colors Z2

0 Black	4 Yellow	8 Slate
1 Brown	5 Green	9 White
2 Red	6 Blue	
3 Orange	7 Violet	

These wires also available in 500 ft (152 m) put-ups.



Hook-Up Wire

600 V, PVC

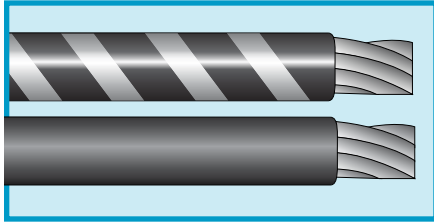

MIL-DTL-16878/1 (Type B) MIL-W-76 Type LW

Operating Temperature

- -55°C to +105°C

Materials

- Stranded or solid tinned copper conductor
- PVC insulation

Availability

100 ft (30.5 m)
1000 ft (305 m)

Part No.	Wire Size		Stranding		Insulation Thickness		Nominal Diameter		Colors
	AWG	mm ²	AWG	mm	Inch	mm	Inch	mm	
1850	32	0.03	7/40	7 x 0.08	0.010	0.25	0.029	0.74	Z1, 1 - 6
1851*	30	0.06	7/38	7 x 0.10	0.010	0.25	0.032	0.81	Z1, 1 - 6
1852*	28	0.09	7/36	7 x 0.12	0.010	0.25	0.035	0.89	Z1, 1 - 10
1853*	26	0.14	7/34	7 x 0.16	0.010	0.25	0.039	0.99	Z1, 1 - 19
172619	26	0.15	19/38	19 x 0.10	0.010	0.25	0.040	1.02	Z2, 0 - 9
1854*	24	0.23	7/32	7 x 0.20	0.010	0.25	0.044	1.12	Z1, 1 - 19
1854/19	24	0.24	19/36	19 x 0.13	0.010	0.25	0.045	1.14	Z1, 1 - 19
1855	22	0.35	7/30	7 x 0.25	0.010	0.25	0.050	1.27	Z1, 1 - 19
1855/19	22	0.38	19/34	19 x 0.16	0.010	0.25	0.052	1.32	Z1, 1 - 19
1856*	20	0.56	7/28	7 x 0.32	0.010	0.25	0.058	1.47	Z1, 1 - 19
1856/19	20	0.62	19/32	19 x 0.20	0.010	0.25	0.060	1.52	Z1, 1 - 19
1857	18	0.90	7/26	7 x 0.40	0.010	0.25	0.068	1.73	Z1, 1 - 19
1857/19	18	0.96	19/30	19 x 0.25	0.010	0.25	0.070	1.78	Z1, 1 - 19
1858/19	16	1.23	19/29	19 x 0.29	0.010	0.25	0.076	1.93	Z1, 1 - 19
1859/19	14	1.94	19/27	19 x 0.36	0.010	0.25	0.091	2.31	Z1, 1 - 10

*Also meets MIL-W-76 Type LW.

Insulation Colors Z1

1 White	5 Yellow	9 Slate	13 White/Green	17 White/Orange
2 Black	6 Blue	10 Violet	14 White/Yellow	18 White/Slate
3 Red	7 Brown	11 White/Black	15 White/Blue	19 White/Violet
4 Green	8 Orange	12 White/Red	16 White/Brown	

Insulation Colors Z2

0 Black	4 Yellow	8 Slate
1 Brown	5 Green	9 White
2 Red	6 Blue	
3 Orange	7 Violet	

Hook-Up Wire

600 V, PVC

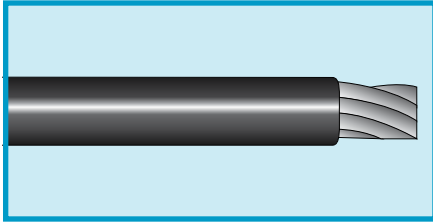

Part No.	Wire Size		Stranding		Insulation Thickness		Nominal Diameter	
	AWG	mm ²	AWG	mm	Inch	mm	Inch	mm
1579	14	2.08	41/30	41 x 0.25	0.045	1.14	0.164	4.17
1651	12	3.29	65/30	65 x 0.25	0.045	1.14	0.183	4.65
1653	10	5.32	105/30	105 x 0.25	0.045	1.14	0.210	5.33
1655	8	8.61	133/29	133 x 0.28	0.045	1.14	0.259	6.58

MIL-W-76 Type HW

Operating Temperature

- -20°C to +80°C

Materials

- Stranded tinned copper conductor
- PVC insulation

Availability

100 ft (30.5 m)
1000 ft (305 m)

Insulation Colors

White
Black
Red

Hook-Up Wire

600 V, PVC

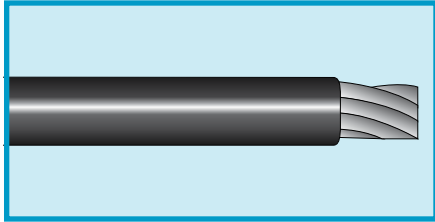

MIL-DTL-16878/2 (Type C)
UL VW-1

Operating Temperature

- -55°C to +105°C

Materials

- Stranded tinned copper conductor
- PVC insulation

Availability

100 ft (30.5 m)
1000 ft (305 m)

Part No.	Wire Size		Stranding		Insulation Thickness		Nominal Diameter	
	AWG	mm ²	AWG	mm	Inch	mm	Inch	mm
202207	22	0.35	7/30	7 x 0.25	0.017	0.43	0.064	1.63
202007	20	0.56	7/28	7 x 0.32	0.017	0.43	0.072	1.83
201807	18	0.90	7/26	7 x 0.40	0.017	0.43	0.082	2.08
201819	18	0.96	19/30	19 x 0.25	0.017	0.43	0.084	2.13
201619	16	1.23	19/29	19 x 0.29	0.019	0.47	0.093	2.36
201419	14	1.94	19/27	19 x 0.36	0.019	0.47	0.108	2.74
201219	12	3.08	19/25	19 x 0.45	0.019	0.47	0.127	3.23

Insulation Colors

White	Yellow	Slate
Black	Blue	Violet
Red	Brown	
Green	Orange	

Hook-Up Wire

600 V, PVC/Nylon

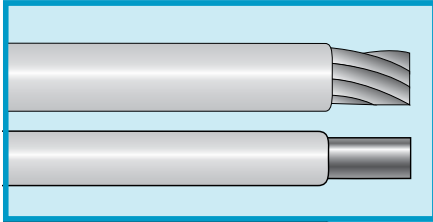

UL THHN, THWN, TFN, TFFN

Operating Temperature

- -40°C to +90°C (THHN, TFN, TFFN)
- -40°C to +75°C (THWN)

Materials

- Stranded or solid bare copper conductor
- PVC/nylon insulation

Availability

100 ft (30.5 m)
500 ft (152 m)
1000 ft (305 m)
Bulk, cut to length

Part No.	Wire Size		Stranding		PVC Insulation Thickness		Nominal Diameter		UL Type
	AWG	mm ²	AWG	mm	Inch	mm	Inch	mm	
541816	18	0.81	16/30	16 x 0.25	0.015	0.38	0.086	2.18	TFFN
541801	18	0.82	Solid	1 x 1.02	0.015	0.38	0.079	2.01	TFN
541626	16	1.32	26/30	26 x 0.25	0.015	0.38	0.099	2.51	TFFN
541419	14	2.07	19/0.0147	19 x 0.37	0.015	0.38	0.113	2.87	THHN, THWN
541401	14	2.08	Solid	1 x 1.63	0.015	0.38	0.103	2.62	THHN, THWN
541219	12	3.29	19/0.0185	19 x 0.47	0.015	0.38	0.132	3.35	THHN, THWN
541201	12	3.31	Solid	1 x 2.06	0.015	0.38	0.120	3.05	THHN, THWN
541019	10	5.26	19/0.0234	19 x 0.59	0.020	0.51	0.166	4.22	THHN, THWN
541001	10	5.26	Solid	1 x 2.59	0.020	0.51	0.141	3.58	THHN, THWN
540819	8	8.38	19/0.0295	19 x 0.75	0.030	0.76	0.219	5.56	THHN, THWN
540619	6	13.32	19/0.0372	19 x 0.94	0.030	0.76	0.257	6.53	THHN, THWN
540419	4	21.09	19/0.0469	19 x 1.19	0.040	1.02	0.329	8.36	THHN, THWN
540219	2	33.63	19/0.0591	19 x 1.50	0.040	1.02	0.390	9.91	THHN, THWN
540001	1/0	53.39	19/0.0745	19 x 1.89	0.050	1.27	0.488	12.40	THHN, THWN

Insulation Colors

White	Yellow	Slate
Black	Blue	Violet
Red	Brown	
Green	Orange	

Hook-Up Wire

600 V, PVC/Nylon

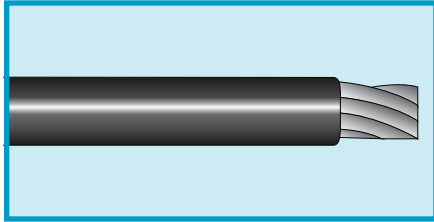

MIL-DTL-16878/17 (Type B/N)

Operating Temperature

- 55°C to +105°C

Materials

- Stranded tinned copper conductor
- PVC/nylon insulation

Availability

100 ft (30.5 m)
 500 ft (152 m)
 1000 ft (305 m)
 Bulk, cut to length

Part No.	Wire Size		Stranding		PVC Insulation Thickness		Nominal Diameter	
	AWG	mm ²	AWG	mm	Inch	mm	Inch	mm
182607	26	0.14	7/34	7 x 0.16	0.010	0.25	0.045	1.14
182407	24	0.23	7/32	7 x 0.20	0.010	0.25	0.050	1.27
182419	24	0.24	19/36	19 x 0.13	0.010	0.25	0.051	1.30
182219	22	0.38	19/34	19 x 0.16	0.010	0.25	0.058	1.47
182019	20	0.62	19/32	19 x 0.20	0.010	0.25	0.066	1.68
181807	18	0.90	7/26	7 x 0.40	0.010	0.25	0.074	1.88
181819	18	0.96	19/30	19 x 0.25	0.010	0.25	0.076	1.93
181619	16	1.23	19/29	19 x 0.29	0.010	0.25	0.082	2.08
181419	14	1.94	19/27	19 x 0.36	0.010	0.25	0.097	2.46

Insulation Colors

White	Yellow	Slate
Black	Blue	Violet
Red	Brown	
Green	Orange	

Hook-Up Wire

1000 V, PVC

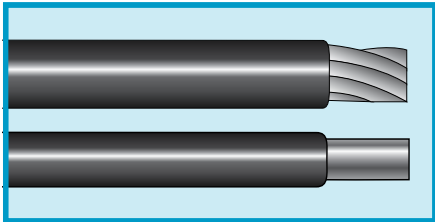

MIL-W-76 Type MWP

Operating Temperature

- -55°C to +90°C

Materials

- Stranded or solid tinned copper conductor
- PVC insulation

Availability

100 ft (30.5 m)
 1000 ft (305 m)
 Bulk, cut to length

Part No.	Wire Size		Stranding		Insulation Thickness		Nominal Diameter	
	AWG	mm ²	AWG	mm	Inch	mm	Inch	mm
302407	24	0.23	7/32	7 x 0.20	0.016	0.41	0.056	1.42
302207	22	0.35	7/30	7 x 0.25	0.016	0.41	0.064	1.63
302201	22	0.32	Solid	1 x 0.64	0.016	0.41	0.057	1.45
302010	20	0.51	10/30	10 x 0.25	0.016	0.41	0.069	1.75
301816	18	0.81	16/30	16 x 0.25	0.016	0.41	0.079	2.01
301626	16	1.32	26/30	26 x 0.25	0.016	0.41	0.092	2.34
301619	16	1.23	19/29	19 x 0.29	0.016	0.41	0.088	2.24
301441	14	2.08	41/30	41 x 0.25	0.016	0.41	0.106	2.69

Insulation Colors

White	Yellow	Slate
Black	Blue	Violet
Red	Brown	
Green	Orange	

Hook-Up Wire

1000 V, PVC

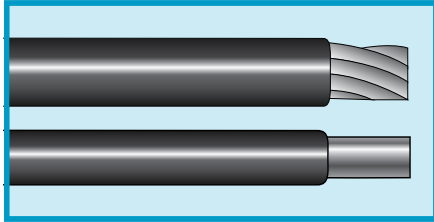

MIL-W-76 B Type MW

Operating Temperature

- -40°C to +80°C

Materials

- Stranded or solid tinned copper conductor
- PVC insulation

Availability

100 ft (30.5 m)
1000 ft (305 m)

Part No.	Wire Size		Stranding		Insulation Thickness		Nominal Diameter		Colors*
	AWG	mm ²	AWG	mm	Inch	mm	Inch	mm	
1550	24	0.23	7/32	7 x 0.20	0.016	0.41	0.056	1.42	1 - 19
1561/24	24	0.20	Solid	1 x 0.51	0.016	0.41	0.052	1.32	1 - 6
1551	22	0.35	7/30	7 x 0.25	0.016	0.41	0.062	1.57	1 - 19
1561	22	0.32	Solid	1 x 0.64	0.016	0.41	0.057	1.45	1 - 6
1553	20	0.51	10/30	10 x 0.25	0.016	0.41	0.069	1.75	1 - 19
1563	20	0.52	Solid	1 x 0.81	0.016	0.41	0.064	1.63	1 - 6
1555	18	0.81	16/30	16 x 0.25	0.016	0.41	0.079	2.01	1 - 19
1565	18	0.82	Solid	1 x 1.02	0.016	0.41	0.072	1.83	1 - 6
1557	16	1.32	26/30	26 x 0.25	0.016	0.41	0.092	2.34	1 - 19
1559	14	2.08	41/30	41 x 0.25	0.016	0.41	0.106	2.69	1 - 10
1560	12	3.29	65/30	65 x 0.25	0.016	0.41	0.125	3.18	1 - 10

Insulation Colors

1 White	5 Yellow	9 Slate	13 White/ Green	17 White/ Orange
2 Black	6 Blue	10 Violet	14 White/ Yellow	18 White/ Slate
3 Red	7 Brown	11 White/ Black	15 White/Blue	19 White/ Violet
4 Green	8 Orange	12 White/Red	16 White/ Brown	

Hook-Up Wire

600/150 V, Irradiated PVC
Soldering Iron Resistant

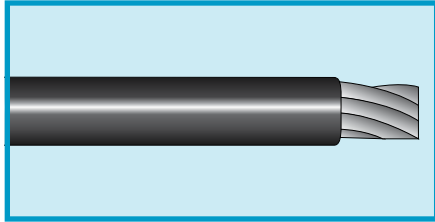

**MIL-DTL-16878/1 (Type B)
(600 V)**
UL AWM 1429 (150 V)
CSA AWM I A/B FT1 (150 V)

Operating Temperature

- -55°C to +105°C (MIL)
- -55°C to +80°C (AWM, CSA)

Materials

- Stranded tinned copper conductor
- Irradiated PVC insulation

Availability

100 ft (30.5 m)
1000 ft (305 m)

Part No.	Wire Size		Stranding		Insulation Thickness		Nominal Diameter	
	AWG	mm ²	AWG	mm	Inch	mm	Inch	mm
7053	26	0.14	7/34	7 x 0.16	0.010	0.25	0.039	0.99
7054	24	0.23	7/32	7 x 0.20	0.010	0.25	0.044	1.12
7054/19	24	0.24	19/36	19 x 0.13	0.010	0.25	0.045	1.14
7055	22	0.35	7/30	7 x 0.25	0.010	0.25	0.050	1.27
7055/19	22	0.38	19/34	19 x 0.16	0.010	0.25	0.052	1.32
7056	20	0.56	7/28	7 x 0.32	0.010	0.25	0.058	1.47
7056/19	20	0.62	19/32	19 x 0.20	0.010	0.25	0.060	1.52
7057	18	0.90	7/26	7 x 0.40	0.010	0.25	0.068	1.73
7057/19	18	0.96	19/30	19 x 0.25	0.010	0.25	0.070	1.78
7058/19	16	1.32	19/0.0117	19 x 0.30	0.010	0.25	0.076	1.93

Insulation Colors

White	Yellow	Slate
Black	Blue	Violet
Red	Brown	
Green	Orange	

Hook-Up Wire

1000/300 V, Irradiated PVC
Soldering Iron Resistant

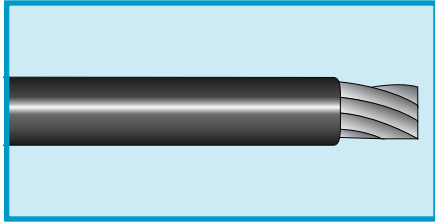

**MIL-DTL-16878/2 (Type C)
(1000 V)**
UL AWM 1430 (300 V)
CSA REW XLPVC FT1 (300 V)

Operating Temperature

- -55°C to +105°C

Materials

- Stranded tinned copper conductor
- Irradiated PVC insulation

Availability

100 ft (30.5 m)
1000 ft (305 m)

Part No.	Wire Size		Stranding		Insulation Thickness		Nominal Diameter		Colors
	AWG	mm ²	AWG	mm	Inch	mm	Inch	mm	
7130	24	0.23	7/32	7 x 0.20	0.016	0.41	0.056	1.42	1 - 10, 29
7131	22	0.35	7/30	7 x 0.25	0.016	0.41	0.062	1.57	1 - 10
7132	20	0.56	7/28	7 x 0.32	0.016	0.41	0.070	1.78	1 - 10
7133	18	0.89	7/26	7 x 0.40	0.016	0.41	0.080	2.03	1 - 10, 29
7134	16	1.32	19/0.0117	19 x 0.30	0.016	0.41	0.088	2.24	1 - 10, 29
7035*	14	2.07	19/0.0147	19 x 0.37	0.016	0.41	0.103	2.62	1 - 10, 29
7036*	12	3.29	19/0.0185	19 x 0.47	0.016	0.41	0.122	3.10	1 - 10, 29

*UL AWM 3317

Insulation Colors

1 White	5 Yellow	9 Slate
2 Black	6 Blue	10 Violet
3 Red	7 Brown	29 Yellow/Green
4 Green	8 Orange	

Hook-Up Wire

3000/600 V, XLPE

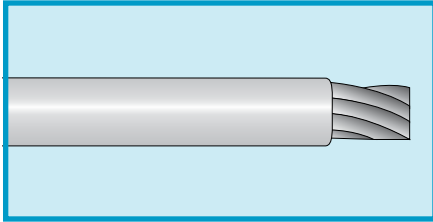

MIL-DTL-16878/4 (Type D)
(3000 V)

UL AWM 3271 (600 V) VW-1
CSA CL 1251 XLPE (600 V)

Operating Temperature

- -55°C to +105°C (MIL)
- -55°C to +125°C (UL, CSA)

Materials

- Stranded tinned copper conductor
- Cross-linked polyolefin insulation

Availability

100 ft (30.5 m)
1000 ft (305 m)

Part No.	Wire Size		Stranding		Insulation Thickness		Nominal Diameter	
	AWG	mm ²	AWG	mm	Inch	mm	Inch	mm
7044	18	0.81	16/30	16 x 0.25	0.032	0.81	0.111	2.82
7045	16	1.32	26/30	26 x 0.25	0.032	0.81	0.119	3.02
7046	14	2.08	41/30	41 x 0.25	0.032	0.81	0.138	3.51
7047	12	3.29	65/30	65 x 0.25	0.032	0.81	0.155	3.94
7048	10	5.32	105/30	105 x 0.25	0.032	0.81	0.184	4.67

Insulation Colors

White
Black
Red

1000/300 V, XLPE

MIL-DTL-16878/2 (Type C)
(1000 V)

UL AWM 3266 (300 V) VW-1
CSA CL 1252 XLPE (300 V)

Operating Temperature

- -55°C to +105°C (MIL)
- -55°C to +125°C (UL, CSA)

Materials

- Stranded tinned copper conductor
- Cross-linked polyolefin insulation

Availability

100 ft (30.5 m)
1000 ft (305 m)

Part No.	Wire Size		Stranding		Insulation Thickness		Nominal Diameter	
	AWG	mm ²	AWG	mm	Inch	mm	Inch	mm
7024	22	0.38	19/34	19 x 0.16	0.016	0.41	0.064	1.63
7025	20	0.62	19/32	19 x 0.20	0.016	0.41	0.072	1.83
7026	18	0.96	19/30	19 x 0.25	0.016	0.41	0.080	2.03

Insulation Colors

White
Black
Red



Hook-Up Wire

600/150 V, XLPE

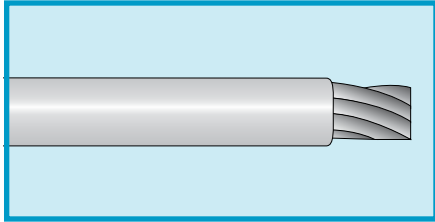

**MIL-DTL-16878/1 (Type B)
(600 V)**
UL AWM 3265 (150 V) VW-1
CSA AWM I A/B FT1 (150 V)

Operating Temperature

- -55°C to +105°C (MIL)
- -55°C to +125°C (UL, CSA)

Materials

- Stranded tinned copper conductor
- Cross-linked polyolefin insulation

Availability

100 ft (30.5 m)
1000 ft (305 m)

Part No.	Wire Size		Stranding		Insulation Thickness		Nominal Diameter	
	AWG	mm ²	AWG	mm	Inch	mm	Inch	mm
7012	22	0.38	19/34	19 x 0.16	0.011	0.28	0.054	1.37
7013	20	0.62	19/32	19 x 0.20	0.011	0.28	0.06	1.52
7014	18	0.96	19/30	19 x 0.25	0.011	0.28	0.070	1.78

Insulation Colors

- White
- Black

Hook-Up Wire

600 V, XLPE

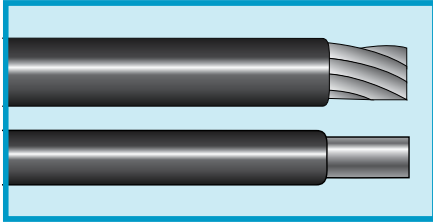
**UL AWM 3173, 3195, 3196****UL SIS****CSA AWM I A/B****CSA CL 1251 XLPE****Availability**

100 ft (30.5 m)

500 ft (152 m)

1000 ft (305 m)

Operating Temperature

- -20°C to +125°C

Materials

- Stranded or solid tinned copper conductor
- Slate cross-linked polyethylene insulation

Part No.	Wire Size		Stranding		Insulation Thickness		Nominal Diameter		UL Style
	AWG	mm ²	AWG	mm	Inch	mm	Inch	mm	
M4030	18	0.81	16/30	16 x 0.25	0.031	0.79	0.110	2.79	3173
M4010	18	0.90	7/26	7 x 0.48	0.031	0.79	0.112	2.84	3173
M4001	18	0.82	Solid	1 x 1.02	0.031	0.79	0.105	2.67	3173
M4011	16	1.43	7/24	7 x 0.51	0.031	0.79	0.123	3.12	3173
M4002	16	1.31	Solid	1 x 1.29	0.031	0.79	0.115	2.92	3173
M4012	14	2.29	7/22	7 x 0.64	0.031	0.79	0.140	3.56	SIS, 3173
M4003	14	2.08	Solid	1 x 1.63	0.031	0.79	0.130	3.30	SIS, 3173
M4013	12	3.29	19/0.0185	19 x 0.47	0.031	0.79	0.160	4.06	SIS, 3173
M4004	12	3.31	Solid	1 x 2.06	0.031	0.79	0.150	3.81	SIS, 3173
M4014	10	5.28	19/0.0234	19 x 0.59	0.031	0.79	0.180	4.57	SIS, 3173
M4005	10	5.26	Solid	1 x 2.59	0.031	0.79	0.170	4.32	SIS, 3173
M4035	8	8.63	133/29	133 x 0.29	0.047	1.19	0.270	6.86	SIS, 3195
M4015	8	8.38	19/0.0295	19 x 0.75	0.047	1.19	0.250	6.35	SIS, 3195
M4036	6	13.6	133/27	133 x 0.36	0.062	1.57	0.340	8.64	SIS, 3196
M4016	6	13.3	19/0.0372	19 x 0.94	0.062	1.57	0.320	8.13	SIS, 3196
M4037	4	21.6	133/25	133 x 0.45	0.062	1.57	0.400	10.16	SIS, 3196

Hook-Up Wire

600 V, XLPE

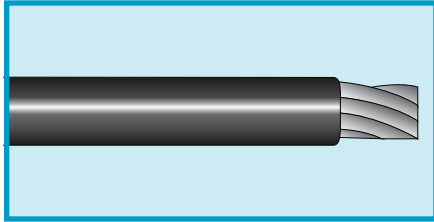

UL AWM 3173
UL SIS
CSA AWM I A/B FT2
CSA CL1251 XLPE

Operating Temperature

- -40°C to +125°C (AWM)
- -40°C to +150°C (CSA CL)
- -40°C to +90°C (SIS)

Materials

- Stranded tinned copper conductor
- Cross-linked polyethylene insulation

Availability

500 ft (152 m)
 1000 ft (305 m)
 Bulk, cut to length

Part No.	Wire Size		Stranding		Insulation Thickness		Nominal Diameter	
	AWG	mm ²	AWG	mm	Inch	mm	Inch	mm
752010	20	0.51	10/30	10 x 0.25	0.031	0.79	0.099	2.51
751816	18	0.81	16/30	16 x 0.25	0.031	0.79	0.109	2.77
751626	16	1.32	26/30	26 x 0.25	0.031	0.79	0.122	3.10
751441*	14	2.08	41/30	41 x 0.25	0.031	0.79	0.136	3.45
751265*	12	3.29	65/30	65 x 0.25	0.031	0.79	0.155	3.94
751000*	10	5.32	105/30	105 x 0.25	0.031	0.79	0.180	4.57
758133**	8	8.63	133/29	133 x 0.29	0.047	1.19	0.263	6.68

*UL SIS.

**UL AWM 3195 only.

Insulation Colors

White	Yellow	Slate
Black	Blue	Violet
Red	Brown	
Green	Orange	

Hook-Up Wire

50 V, XLPE

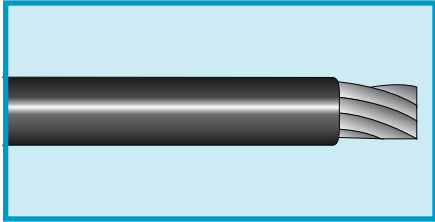

Part No.	Wire Size		Stranding		Insulation Thickness		Nominal Diameter	
	AWG	mm ²	AWG	mm	Inch	mm	Inch	mm
631816	18	0.81	16/30	16 x 0.25	0.023	0.58	0.093	2.36
631619	16	1.23	19/29	19 x 0.29	0.023	0.58	0.102	2.59
631419	14	1.94	19/27	19 x 0.36	0.023	0.58	0.113	2.87

SAE J1128 Type GXL

Operating Temperature

- -40°C to +125°C

Materials

- Stranded bare copper conductor
- Cross-linked polyethylene insulation

Availability

500 ft (152 m)
 1000 ft (305 m)
 Bulk, cut to length

Insulation Colors

White	Yellow	Slate
Black	Blue	Violet
Red	Brown	
Green	Orange	

Hook-Up Wire

250 V, PTFE

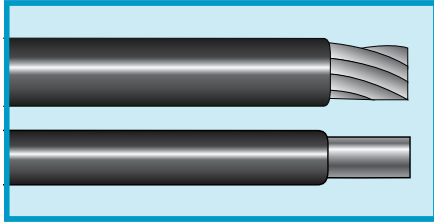

Operating Temperature

- -60°C to +200°C

Materials

- Stranded or solid silver-plated copper conductor
- PTFE insulation

MIL-DTL-16878/6 (Type ET)
UL VW-1
NEMA HP3

Availability

100 ft (30.5 m)
 1000 ft (305 m)*

*May contain multiple lengths

Part No.	Wire Size		Stranding		Insulation Thickness		Nominal Diameter		NEMA HP3 Type	Colors
	AWG	mm ²	AWG	mm	Inch	mm	Inch	mm		
33201	32	0.03	Solid	1 x 0.20	0.006	0.15	0.019	0.48	—	Z2
33219	32	0.04	19/44	19 x 0.05	0.006	0.15	0.022	0.56	—	Z2
2840/7	32	0.03	7/40	7 x 0.08	0.006	0.15	0.022	0.56	ETXBAB	Z1
2841/7	30	0.06	7/38	7 x 0.10	0.006	0.15	0.024	0.61	ETXBBB	Z1
2841/1	30	0.05	Solid	1 x 0.25	0.006	0.15	0.022	0.56	ETXBBA	Z1
2842/7	28	0.09	7/36	7 x 0.12	0.006	0.15	0.027	0.69	ETXBCB	Z1
2842/19	28	0.09	19/40	19 x 0.08	0.006	0.15	0.027	0.69	ETXBCE	Z1
2842/1	28	0.08	Solid	1 x 0.32	0.006	0.15	0.025	0.64	ETXBCA	Z1
2843/7	26	0.14	7/34	7 x 0.16	0.006	0.15	0.031	0.79	ETXBDB	Z1
2843/19	26	0.15	19/38	19 x 0.10	0.006	0.15	0.031	0.79	ETXBDE	Z1
2843/1	26	0.13	Solid	1 x 0.40	0.006	0.15	0.028	0.71	ETXBDA	Z1
2844/7	24	0.23	7/32	7 x 0.20	0.006	0.15	0.036	0.91	ETXBEB	Z1
2844/19	24	0.24	19/36	19 x 0.13	0.006	0.15	0.036	0.91	ETXBEE	Z1
2845/7	22	0.35	7/30	7 x 0.25	0.006	0.15	0.042	1.07	ETXBFB	Z1
2845/19	22	0.38	19/34	19 x 0.16	0.005	0.13	0.042	1.07	ETXBFE	Z1
32007	20	0.56	7/28	7 x 0.32	0.006	0.15	0.050	1.27	ETXBGB	Z2
32019	20	0.62	19/32	19 x 0.20	0.006	0.15	0.052	1.32	ETXBGE	Z2

Insulation Colors Z1

1 White	5 Yellow	9 Slate
2 Black	6 Blue	10 Violet
3 Red	7 Brown	
4 Green	8 Orange	

Insulation Colors Z2

0 Black	4 Yellow	8 Slate
1 Brown	5 Green	9 White
2 Red	6 Blue	
3 Orange	7 Violet	

These wires also available in 500 ft (152 m) put-ups.

Hook-Up Wire

600 V, PTFE

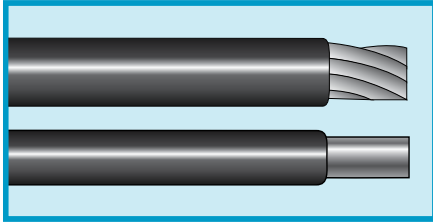

MIL-DTL-16878/4 (Type E)
UL VW-1
NEMA HP3

Operating Temperature

- -60°C to +200°C

Materials

- Stranded or solid silver-plated copper conductor
- PTFE insulation

Availability

100 ft (30.5 m)
 1000 ft (305 m)*

*May contain multiple lengths

Part No.	Wire Size		Stranding		Insulation Thickness		Nominal Diameter		NEMA HP-3
	AWG	mm ²	AWG	mm	Inch	mm	Inch	mm	
13207	32	0.03	7/40	7 x 0.08	0.010	0.25	0.029	0.74	EXBAB
13001	30	0.05	Solid	1 x 0.25	0.010	0.25	0.030	0.76	EXBBA
12819	28	0.09	19/40	19 x 0.07	0.010	0.25	0.036	0.91	—
12819UL*	28	0.09	19/40	19 x 0.07	0.010	0.25	0.036	0.91	—
11807	18	0.90	7/26	7 x 0.40	0.010	0.25	0.068	1.73	EXBHB

*UL AWM 1212 and AWM 1213 and -55°C to +105°C temperature range.

Insulation Colors

White	Yellow	Slate
Black	Blue	Violet
Red	Brown	
Green	Orange	



Hook-Up Wire

600 V, PTFE

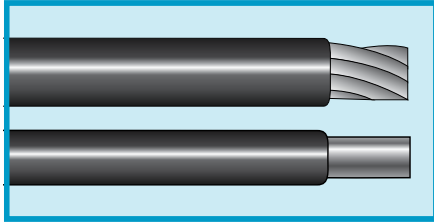

**MIL-DTL-16878/4 (Type E)
(600 V)
UL AWM 1213*
NEMA HP3**

Operating Temperature

- -60°C to +200°C (MIL)
- -60°C to +105°C (UL)

Materials

- Stranded or solid silver-plated copper conductor
- PTFE insulation

Availability

100 ft (30.5 m)
1000 ft (305 m)[†]

[†]May contain multiple lengths

Part No.	Wire Size		Stranding		Insulation Thickness		Nominal Diameter		NEMA HP3 Type
	AWG	mm ²	AWG	mm	Inch	mm	Inch	mm	
5851	30	0.06	7/38	7 x 0.10	0.010	0.25	0.032	0.81	EXBBB
5852	28	0.09	7/36	7 x 0.13	0.010	0.25	0.035	0.89	EXBCB
5853	26	0.14	7/34	7 x 0.16	0.010	0.25	0.039	0.99	EXBDB
5853/19	26	0.15	19/38	19 x 0.10	0.010	0.25	0.039	0.99	EXBDE
2853/1	26	0.13	Solid	1 x 0.40	0.010	0.25	0.036	0.91	EXBDA
5854	24	0.24	19/36	19 x 0.13	0.010	0.25	0.044	1.12	EXBEE
5854/7	24	0.23	7/32	7 x 0.20	0.010	0.25	0.044	1.12	EXBEB
2854/1	24	0.20	Solid	1 x 0.51	0.010	0.25	0.040	1.02	EXBEA
5855	22	0.38	19/34	19 x 0.16	0.010	0.25	0.050	1.27	EXBFE
5855/7	22	0.35	7/30	7 x 0.25	0.010	0.25	0.050	1.27	EXBFB
2855/1	22	0.32	Solid	1 x 0.64	0.010	0.25	0.045	1.14	EXBFA
5856	20	0.62	19/32	19 x 0.20	0.010	0.25	0.058	1.47	EXBGE
5856/7	20	0.56	7/28	7 x 0.32	0.010	0.25	0.058	1.47	EXBGB
2856/1***	20	0.52	Solid	1 x 0.81	0.010	0.25	0.052	1.32	EXBGA
5857	18	0.96	19/30	19 x 0.25	0.010	0.25	0.069	1.75	EXBHE
2857/1***	18	0.82	Solid	1 x 1.02	0.011	0.27	0.061	1.55	EXBHA
5858	16	1.23	19/29	19 x 0.29	0.012	0.30	0.080	2.03	EXBJE
5859[†]	14	1.94	19/27	19 x 0.36	0.012	0.30	0.095	2.41	EXBKE
5859/12[†]	12	3.08	19/25	19 x 0.45	0.012	0.30	0.114	2.90	EXBLE
5859/10[†]	10	4.74	37/26	37 x 0.40	0.012	0.30	0.134	3.40	EXBMG

*Voltage rating not specified.

***White, black, red only.

[†]White only, not UL AWM 1213.

Insulation Colors

White	Yellow	Slate
Black	Blue	Violet
Red	Brown	
Green	Orange	

Hook-Up Wire

1000/300 V, PTFE

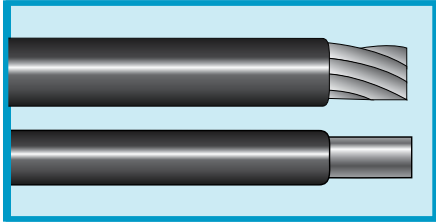

**MIL-DTL-16878/5 (TYPE EE)
(1000V)
UL AWM 1180 (300V)
NEMA HP3**

Operating Temperature

- -60°C to +200°C

Materials

- Stranded or solid silver-plated copper conductor
- PTFE insulation

Availability

100 ft (30.5 m)

1000 ft (305 m)*

*May contain multiple lengths

Part No.	Wire Size		Stranding		Insulation Thickness		Nominal Diameter		NEMA HP3 Type
	AWG	mm ²	AWG	mm	Inch	mm	Inch	mm	
5874	24	0.24	19/36	19 x 0.13	0.015	0.37	0.054	1.37	EEXBEE
5875	22	0.38	19/34	19 x 0.16	0.014	0.36	0.060	1.52	EEXBFE
5876	20	0.62	19/32	19 x 0.20	0.014	0.36	0.068	1.73	EEXBGE
5877	18	0.96	19/30	19 x 0.25	0.015	0.37	0.079	2.01	EEXBHE
5878	16	1.23	19/29	19 x 0.29	0.016	0.41	0.089	2.26	EEXBJE
5879	14	1.94	19/27	19 x 0.36	0.017	0.43	0.106	2.69	EEXBKE
5879/10	10	4.74	37/26	37 x 0.40	0.017	0.43	0.145	3.68	EEXBMG
5879/12	12	3.08	19/25	19 x 0.45	0.017	0.43	0.125	3.18	EEXBLE
5879/8*	8	8.61	133/29	133 x 0.29	0.020	0.51	0.209	5.31	EEXBNL

*Not UL AWM 1180.

Insulation Colors

White	Yellow	Slate
Black	Blue	Violet
Red	Brown	
Green	Orange	

Parts 5878, 5879, 5879/8, 5879/10, 5879/12: white only.

Hook-Up Wire

1000 V, PTFE

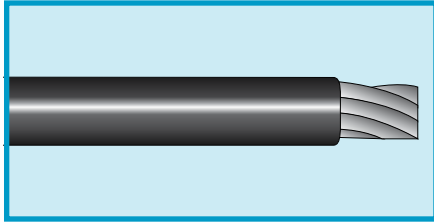

Part No.	Wire Size		Stranding		Insulation Thickness		Nominal Diameter		NEMA HP-3
	AWG	mm ²	AWG	mm	Inch	mm	Inch	mm	
22807	28	0.09	7/36	7 x 0.13	0.015	0.38	0.045	1.14	EEXBCB
22407	24	0.23	7/32	7 x 0.20	0.015	0.38	0.054	1.37	EEXBEB
22207	22	0.35	7/30	7 x 0.25	0.014	0.36	0.058	1.47	EEXBFB
22007	20	0.56	7/28	7 x 0.32	0.015	0.38	0.068	1.73	EXBGB

MIL-DTL-16878/5 (Type EE)
UL VW-1
NEMA HP3

Operating Temperature

- -60°C to +200°C

Materials

- Stranded silver-plated copper conductor
- PTFE insulation

Availability

100 ft (30.5 m)
 500 ft (152 m)
 1000 ft (305 m)*

*May contain multiple lengths

Insulation Colors

White	Yellow	Slate
Black	Blue	Violet
Red	Brown	
Green	Orange	



Hook-Up Wire

600 V, ETFE or PTFE

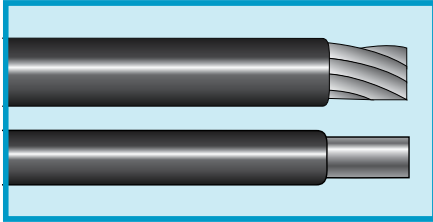

SAE AS22759/11
(MIL-DTL-22759/11)
SAE AS22759/16
(MIL-DTL-22759/16)

Operating Temperature

- -55°C to +200°C (PTFE)
- -55°C to +150°C (ETFE)

Materials

- Stranded silver-plated copper conductors (SAE AS22759/11)
- Stranded tinned copper conductor (SAE AS22759/16)
- ETFE or PTFE insulation

Availability

100 ft (30.5 m)
500 ft (152 m)
1000 ft (305 m)*

*May contain multiple lengths

PTFE, SAE AS22759/11, -55°C to +200°C, Silver-Plated Copper Conductors

Part No.	Wire Size		Stranding		Insulation Thickness		Nominal Diameter	
	AWG	mm ²	AWG	mm	Inch	mm	Inch	mm
AT261938	26	0.15	19/38	19 x 0.10	0.010	0.25	0.038	0.97
AT241936	24	0.24	19/36	19 x 0.13	0.009	0.23	0.043	1.09
AT221934	22	0.38	19/34	19 x 0.16	0.009	0.23	0.049	1.24
AT201932	20	0.62	19/32	19 x 0.20	0.011	0.28	0.058	1.47
AT181930	18	0.96	19/30	19 x 0.25	0.010	0.25	0.068	1.73
AT161929	16	1.23	19/29	19 x 0.29	0.010	0.25	0.075	1.90
AT141927	14	1.94	19/27	19 x 0.36	0.011	0.27	0.090	2.29
AT121925	12	3.08	19/25	19 x 0.45	0.013	0.32	0.111	2.82
AT103726	10	4.74	37/26	37 x 0.40	0.015	0.38	0.139	3.53
AT813329	8	8.61	133/29	133 x 0.29	0.019	0.48	0.202	5.13

ETFE, SAE AS22759/16, -55°C to +150°C, Tinned Copper Conductors

Part No.	Wire Size		Stranding		Insulation Thickness		Nominal Diameter	
	AWG	mm ²	AWG	mm	Inch	mm	Inch	mm
AZ241936	24	0.24	19/36	19 x 0.13	0.011	0.27	0.045	1.14
AZ221934	22	0.38	19/34	19 x 0.16	0.011	0.28	0.052	1.32
AZ201932	20	0.62	19/32	19 x 0.20	0.011	0.28	0.060	1.52
AZ181930	18	0.96	19/30	19 x 0.25	0.012	0.29	0.071	1.80
AZ161929	16	1.23	19/29	19 x 0.29	0.013	0.33	0.079	2.01
AZ141927	14	1.94	19/27	19 x 0.36	0.013	0.33	0.093	2.36
AZ123728	12	2.97	37/28	37 x 0.32	0.014	0.34	0.114	2.90
AZ103726	10	4.74	37/26	37 x 0.40	0.015	0.38	0.139	3.53
AZ813329	8	8.63	133/29	133 x 0.29	0.018	0.47	0.199	5.05
AZ413325	4	21.6	133/25	133 x 0.45	0.026	0.66	0.312	7.92

Insulation Colors

White	Yellow	Slate
Black	Blue	Violet
Red	Brown	
Green	Orange	

Hook-Up Wire

Wire Wrap, PVDF or ETFE

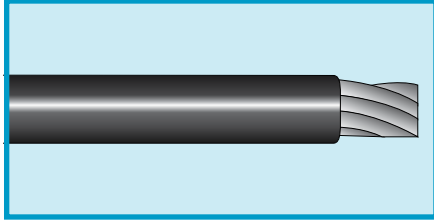

UL 1422, 1423, 1516, 1523 VW-1

Operating Temperature

- -40°C to +125°C (PVDF)
- -70°C to +150°C (ETFE)
- +105°C (UL)

Materials

- Silver-plated solid copper conductors
- PVDF or ETFE insulation

Availability

100 ft (30.5 m) (ETFE)
1000 ft (305 m) (PVDF or ETFE)

Part No.	Wire Size		Insulation Thickness		Nominal Diameter		UL Style
	AWG	mm ²	Inch	mm	Inch	mm	
5951	30	0.05	0.005	0.11	0.019	0.51	1423
5952	28	0.08	0.006	0.14	0.024	0.61	1422
5953	26	0.13	0.006	0.14	0.027	0.69	1422
5954	24	0.20	0.005	0.11	0.030	0.76	1423

Part No.	Wire Size		Insulation Thickness		Nominal Diameter		UL Style
	AWG	mm ²	Inch	mm	Inch	mm	
1805	30	0.05	0.005	0.11	0.020	0.51	1516
1806*	28	0.08	0.006	0.14	0.024	0.61	1523
1807	26	0.13	0.006	0.14	0.027	0.69	1523
1808**	24	0.20	0.005	0.11	0.030	0.76	1516

*Not available in orange.

**Not available in violet or orange.

Insulation Colors

White	Yellow	Slate
Black	Blue	Violet
Red	Brown	
Green	Orange	

Hook-Up Wire

Test Lead Wire, EPR Rubber

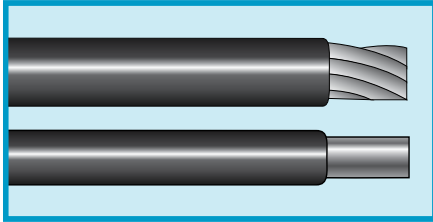

Part No.	Wire Size		Stranding		Insulation Thickness		Nominal Diameter		Breakdown Voltage (RMS)	Working Voltage (RMS)
	AWG	mm ²	AWG	mm	Inch	mm	Inch	mm		
1632	20	0.52	41/36	41 x 0.13	0.040	1.02	0.118	3.00	6000	1500
1635	20	0.52	41/36	41 x 0.13	0.047	1.19	0.132	3.35	12,000	3000
1636	18	0.83	65/36	65 x 0.13	0.045	1.14	0.137	3.48	20,000	5000

Operating Temperature

- -30°C to +90°C

Voltage Rating

- See table

Materials

- Stranded tinned copper conductors
- EPR rubber insulation

Availability

100 ft (30.5 m)
 500 ft (152 m)
 1000 ft (305 m)

Insulation Colors

Black

Red



Hook-Up Wire

600 V, Silicone Rubber

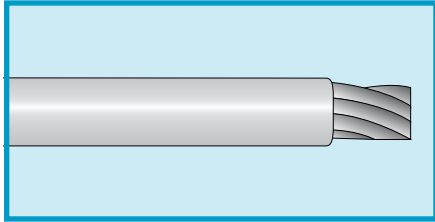

UL AWM 3212, 3213, 3214
CSA AWM I A/B FT2

Operating Temperature

- -40°C to +150°C

Materials

- Stranded tinned copper conductor
- White silicone rubber insulation

Availability

100 ft (30.5 m)
500 ft (152 m)
1000 ft (305 m)
Bulk, cut to length

Part No.	Wire Size		Stranding		Insulation Thickness		Nominal Diameter		UL AWM
	AWG	mm ²	AWG	mm	Inch	mm	Inch	mm	
392207	22	0.35	7/30	7 x 0.25	0.047	1.19	0.124	3.15	3212
392010	20	0.51	10/30	10 x 0.25	0.047	1.19	0.131	3.33	3212
391816	18	0.81	16/30	16 x 0.25	0.047	1.19	0.141	3.58	3212
391626	16	1.32	26/30	26 x 0.25	0.047	1.19	0.154	3.91	3212
391441	14	2.08	41/30	41 x 0.25	0.047	1.19	0.168	4.27	3212
391265	12	3.29	65/30	65 x 0.25	0.047	1.19	0.187	4.75	3212
391000	10	5.32	105/30	105 x 0.25	0.047	1.19	0.212	5.38	3212
398133	8	8.61	133/29	133 x 0.29	0.063	1.60	0.295	7.49	3213
396133	6	13.57	133/27	133 x 0.36	0.063	1.60	0.339	8.61	3213
394133	4	21.55	133/25	133 x 0.45	0.063	1.60	0.395	10.03	3213
392259	2	33.15	259/26	259 x 0.40	0.063	1.60	0.460	11.68	3213
391259	1	41.96	259/25	259 x 0.45	0.078	1.98	0.532	13.51	3214
390001	1/0	53.10	259/24	259 x 0.51	0.078	1.98	0.578	14.68	3214
390002	2/0	67.43	1330/30	1330 x 0.25	0.078	1.98	0.639	16.23	3214
390004	4/0	106.82	2107/30	2107 x 0.25	0.078	1.98	0.837	21.26	3214

Hook-Up Wire

High-Temperature Appliance Wire
600 V, Silicone Rubber, Glass Braid

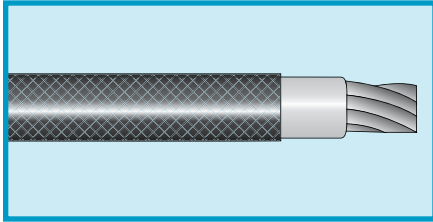

**UL AWM 3070, 3071,
3074, 3075**
UL SF-2, SFF-2
CSA SEW-2, SEWF-2

Operating Temperature

- -40°C to +200°C (UL SF-2, CSA SEW-2)
- -40°C to +150°C (UL SFF-2, CSA SEWF-2)

Materials

- Stranded tinned copper conductor
- Silicon rubber insulation
- Glass braid jacket

Availability

100 ft (30.5 m)
500 ft (152 m)
1000 ft (305 m)
Bulk, cut to length

Part No.	Wire Size		Stranding		Insulation Thickness		Nominal Diameter		Approval	
	AWG	mm ²	AWG	mm	Inch	mm	Inch	mm	UL	CSA
M4101	18	0.82	7/0.0152	7 x 0.39	0.032	0.81	0.124	3.15	3071, SF-2	SEW-2
M4110	18	0.81	16/30	16 x 0.25	0.032	0.81	0.130	3.30	3070, SFF-2	SEWF-2
M4102	16	1.31	7/0.0192	7 x 0.49	0.032	0.81	0.136	3.45	3071, SF-2	SEW-2
M4111	16	1.32	26/30	26 x 0.25	0.032	0.81	0.140	3.56	3070, SFF-2	SEWF-2
M4103	14	2.08	7/0.0242	7 x 0.61	0.032	0.81	0.152	3.86	3071, SF-2	SEW-2
M4112	14	2.08	41/30	41 x 0.25	0.032	0.81	0.160	4.06	3070, SFF-2	SEWF-2
M4104	12	3.08	19/25	19 x 0.45	0.032	0.81	0.166	4.22	3074, SF-2	SEW-2
M4113	12	3.29	65/30	65 x 0.25	0.032	0.81	0.180	4.57	3070, SFF-2	SEWF-2
M4105	10	4.92	19/23	19 x 0.57	0.048	1.22	0.221	5.61	3075, SF-2	SEW-2

Insulation Colors

White

Black

Hook-Up Wire

High-Temperature Type SRML Motor Lead
600 V, Silicone Rubber

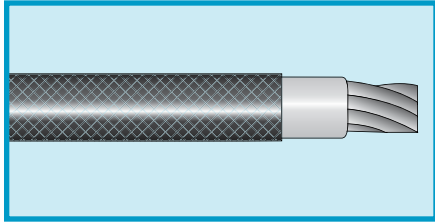

**UL AWM 3101, 3231, 3278
CSA SEW-2, SEWF-2**

Operating Temperature

- -40°C to +200°C (AWM 3231, SEW-2)
- -40°C to +150°C (AWM 3101, 3278, SEWF-2)

Materials

- Stranded tinned copper conductor
- Silicon rubber insulation
- Black or white glass braid jacket

Availability

100 ft (30.5 m)
500 ft (152 m)
1000 ft (305 m)
Bulk, cut to length

Part No.	Wire Size		Stranding		Insulation Thickness		Nominal Diameter		UL AWM Style	CSA Type
	AWG	mm ²	AWG	mm	Inch	mm	Inch	mm		
M4114	10	5.32	105/30	105 x 0.25	0.047	1.19	0.230	5.84	3101	SEWF-2
M4115	8	8.29	133/.0111	133 x 0.28	0.062	1.57	0.305	7.75	3278	SEWF-2
M4116	6	13.6	133/27	133 x 0.36	0.062	1.57	0.345	8.76	3278	SEWF-2
M4117	4	21.1	133/.0177	133 x 0.45	0.062	1.57	0.400	10.16	3231	SEW-2
M4118	2	33.5	133/.0223	133 x 0.57	0.062	1.57	0.470	11.94	3231	SEW-2
M4120	1/0	53.5	259/.0202	259 x 0.51	0.085	2.16	0.605	15.37	3231	SEW-2
M4121	2/0	68.8	259/.0229	259 x 0.58	0.085	2.16	0.660	16.76	3231	SEW-2
M4122	3/0	85.3	259/.0255	259 x 0.65	0.085	2.16	0.715	18.16	3231	SEW-2
M4123	4/0	107	259/.0286	259 x 0.73	0.085	2.16	0.785	19.94	3231	SEW-2

Insulation Colors

White

Black

Hook-Up Wire

High Voltage, Silicone Rubber

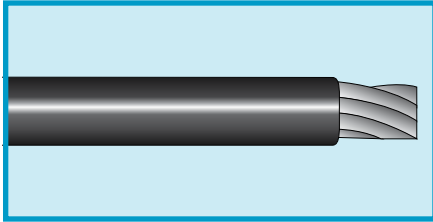

UL AWM 3239

Operating Temperature

- -40°C to +150°C

Materials

- Stranded tinned copper conductor
- Silicone rubber insulation

Availability

100 ft (30.5 m)
500 ft (152 m)
1000 ft (305 m)

UL 3239

Part No.	Wire Size		Stranding		Insulation Thickness		Nominal Diameter		Voltage
	AWG	mm ²	AWG	mm	Inch	mm	Inch	mm	
392297	22	0.35	7/30	7 x 0.25	0.097	2.46	0.224	5.69	40 kV
392275	22	0.35	7/30	7 x 0.25	0.075	1.90	0.180	4.57	30 kV
392262	22	0.35	7/30	7 x 0.25	0.062	1.57	0.154	3.91	25 kV
392250	22	0.35	7/30	7 x 0.25	0.050	1.27	0.131	3.33	20 kV
392245	22	0.35	7/30	7 x 0.25	0.045	1.14	0.120	3.05	15 kV
392240	22	0.35	7/30	7 x 0.25	0.040	1.02	0.11	2.79	10 kV
392097	20	0.51	10/30	10 x 0.25	0.097	2.46	0.231	5.87	40 kV
392075	20	0.51	10/30	10 x 0.25	0.075	1.90	0.187	4.75	30 kV
392062	20	0.51	10/30	10 x 0.25	0.062	1.57	0.161	4.09	25 kV
392050	20	0.51	10/30	10 x 0.25	0.050	1.27	0.137	3.48	20 kV
392045	20	0.51	10/30	10 x 0.25	0.045	1.14	0.127	3.23	15 kV
392040	20	0.51	10/30	10 x 0.25	0.040	1.02	0.117	2.97	10 kV
391897	18	0.81	16/30	16 x 0.25	0.097	2.46	0.241	6.12	40 kV
391875	18	0.81	16/30	16 x 0.25	0.075	1.90	0.197	5.00	30 kV
391862	18	0.81	16/30	16 x 0.25	0.062	1.57	0.171	4.34	25 kV
391850	18	0.81	16/30	16 x 0.25	0.050	1.27	0.147	3.73	20 kV
391845	18	0.81	16/30	16 x 0.25	0.045	1.14	0.137	3.48	15 kV
391840	18	0.81	16/30	16 x 0.25	0.040	1.02	0.127	3.23	10 kV
391699	16	1.32	26/30	26 x 0.25	0.150	3.81	0.360	9.14	50 kV
391697	16	1.32	26/30	26 x 0.25	0.097	2.46	0.254	6.45	40 kV
391675	16	1.32	26/30	26 x 0.25	0.075	1.90	0.210	5.33	30 kV
391662	16	1.32	26/30	26 x 0.25	0.062	1.57	0.184	4.67	25 kV
391650	16	1.32	26/30	26 x 0.25	0.050	1.27	0.160	4.06	20 kV
391645	16	1.32	26/30	26 x 0.25	0.045	1.14	0.150	3.81	15 kV
391640	16	1.32	26/30	26 x 0.25	0.040	1.02	0.140	3.56	10 kV
391499	14	2.08	41/30	41 x 0.25	0.150	3.81	0.374	9.50	50 kV
391497	14	2.08	41/30	41 x 0.25	0.097	2.46	0.268	6.81	40 kV
391475	14	2.08	41/30	41 x 0.25	0.075	1.90	0.224	5.69	30 kV
391462	14	2.08	41/30	41 x 0.25	0.062	1.57	0.198	5.03	25 kV
391450	14	2.08	41/30	41 x 0.25	0.050	1.27	0.174	4.42	20 kV
391445	14	2.08	41/30	41 x 0.25	0.045	1.14	0.164	4.17	15 kV
391440	14	2.08	41/30	41 x 0.25	0.040	1.02	0.154	3.91	10 kV

White Black Red

Hook-Up Wire

High Voltage, Silicone Rubber

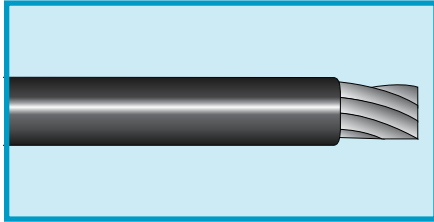

UL AWM 3239

Operating Temperature

- -40°C to +150°C

Materials

- Stranded tinned copper conductor
- Silicone rubber insulation

Availability

100 ft (30.5 m)
500 ft (152 m)
1000 ft (305 m)

UL 3239

Part No.	Wire Size		Stranding		Insulation Thickness		Nominal Diameter		Voltage
	AWG	mm ²	AWG	mm	Inch	mm	Inch	mm	
391297	12	3.29	65/30	65 x 0.25	0.097	2.46	0.287	7.29	40 kV
391275	12	3.29	65/30	65 x 0.25	0.075	1.90	0.243	6.17	30 kV
391262	12	3.29	65/30	65 x 0.25	0.062	1.57	0.217	5.51	25 kV
391250	12	3.29	65/30	65 x 0.25	0.050	1.27	0.193	4.90	20 kV
391245	12	3.29	65/30	65 x 0.25	0.045	1.14	0.183	4.65	15 kV
391099	10	5.32	105/30	105 x 0.25	0.150	3.81	0.418	10.62	50 kV
391097	10	5.32	105/30	105 x 0.25	0.097	2.46	0.312	7.92	40 kV
391045	10	5.32	105/30	105 x 0.25	0.045	1.14	0.208	5.28	15 kV
391040	10	5.32	105/30	105 x 0.25	0.040	1.02	0.198	5.03	10 kV
390897	8	8.61	133/29	133 x 0.28	0.097	2.46	0.363	9.22	40 kV
390862*	8	8.61	133/29	133 x 0.28	0.062	1.57	0.293	7.44	25 kV
390845	8	8.61	133/29	133 x 0.28	0.045	1.14	0.259	6.58	15 kV
390662*	6	13.57	133/27	133 x 0.36	0.062	1.57	0.337	8.56	25 kV
390645	6	13.57	133/27	133 x 0.36	0.045	1.14	0.303	7.70	15 kV
390462*	4	21.55	133/25	133 x 0.45	0.062	1.57	0.393	9.98	25 kV
390262*	2	34.45	259/26	259 x 0.40	0.062	1.57	0.463	11.76	25 kV

*Not UL Recognized.

Insulation Colors

White	Black	Red
-------	-------	-----

Hook-Up Wire

High Voltage, Silicone Rubber

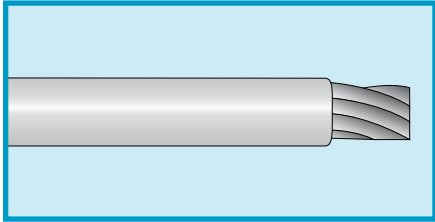

UL VW-1

Operating Temperature

- -40°C to +200°C

Materials

- Stranded silver-plated copper conductor
- White silicone rubber insulation

Availability

100 ft (30.5 m)
 500 ft (152 m)
 1000 ft (305 m)
 Bulk, cut to length

Part No.	Wire Size		Stranding		Insulation Thickness		Nominal Diameter		Voltage
	AWG	mm ²	AWG	mm	Inch	mm	Inch	mm	
39X2220	22	0.35	7/30	7 x 0.25	0.050	1.27	0.130	3.30	20 kV
39X2215	22	0.35	7/30	7 x 0.25	0.040	1.02	0.110	2.79	15 kV
39X2205	22	0.35	7/30	7 x 0.25	0.020	0.51	0.070	1.78	5 kV
39X2025	20	0.62	19/32	19 x 0.20	0.063	1.60	0.166	4.22	25 kV
39X2020	20	0.62	19/32	19 x 0.20	0.055	1.40	0.150	3.81	20 kV
39X2015	20	0.62	19/32	19 x 0.20	0.040	1.02	0.120	3.05	15 kV
39X1825	18	0.96	19/30	19 x 0.25	0.055	1.40	0.160	4.06	25 kV
39X1660	16	1.32	26/30	26 x 0.25	0.162	4.11	0.384	9.75	60 kV
39X1645	16	1.23	19/29	19 x 0.28	0.125	3.18	0.306	7.77	45 kV
39X1635	16	1.23	41/32	41 x 0.20	0.105	2.67	0.269	6.83	35 kV
39X1620	16	1.33	41/32	41 x 0.20	0.053	1.33	0.164	4.17	20 kV
39X1460	14	1.94	19/27	19 x 0.36	0.157	3.99	0.385	9.78	60 kV
39X1260	12	3.08	19/25	19 x 0.45	0.178	4.51	0.445	11.30	60 kV

Hook-Up Wire

High Temperature
600 V, Mica-Glass, PTFE

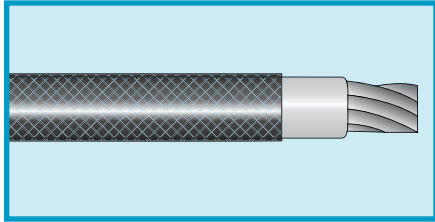

UL AWM 5107
CSA AWM I A/B

Operating Temperature

- -55°C to +538°C
- -55°C to +450°C (UL, CSA)

Materials

- Stranded nickel-plated copper conductor
- Mica-glass tape insulation
- Tan PTFE-impregnated fiberglass jacket

Availability

100 ft (30.5 m)
500 ft (152 m)
1000 ft (305 m)
Bulk, cut to length

Part No.	Wire Size		Stranding		Insulation Thickness		Nominal Diameter	
	AWG	mm ²	AWG	mm	Inch	mm	Inch	mm
3112010	20	0.51	10/30	10 x 0.25	0.025	0.64	0.101	2.57
3111816	18	0.81	16/30	16 x 0.25	0.025	0.64	0.111	2.82
3111626	16	1.32	26/30	26 x 0.25	0.025	0.64	0.124	3.15
3111441	14	2.08	41/30	41 x 0.25	0.025	0.64	0.138	3.51
3111265	12	3.29	65/30	65 x 0.25	0.025	0.64	0.157	3.99
3111000	10	5.32	105/30	105 x 0.25	0.030	0.76	0.206	5.23
3118133	8	8.63	133/29	133 x 0.28	0.030	0.76	0.260	6.60
3116133	6	13.6	133/27	133 x 0.36	0.030	0.76	0.304	7.72
3114133	4	21.6	133/25	133 x 0.36	0.030	0.76	0.361	9.17
3112133	2	34.4	133/23	133 x 0.57	0.035	0.89	0.444	11.28

Hook-Up Wire

High Temperature
600 V, PTFE/Glass Braid

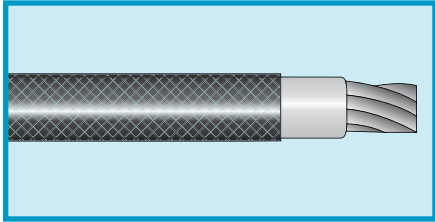

UL AWM 5196
CSA AWM I A/B

Part No.	Wire Size		Stranding		Insulation Thickness		Nominal Diameter	
	AWG	mm ²	AWG	mm	Inch	mm	Inch	mm
3131816	18	0.81	16/30	16 x 0.25	0.016	0.41	0.109	2.77
3131626	16	1.32	26/30	26 x 0.25	0.016	0.41	0.122	3.10
3131441	14	2.08	41/30	41 x 0.25	0.016	0.41	0.136	3.45
3131265	12	3.29	65/30	65 x 0.25	0.016	0.41	0.155	3.94
3131000	10	5.32	105/30	105 x 0.25	0.016	0.41	0.180	4.57
3138133	8	8.61	133/29	133 x 0.29	0.016	0.41	0.232	5.89
3136133	6	13.6	133/27	133 x 0.36	0.016	0.41	0.315	8.00

Operating Temperature

- -55°C to +250°C

Materials

- Stranded nickel-plated copper conductor
- White PTFE tape insulation
- Double fiberglass serve
- Tan PTFE-impregnated fiberglass jacket

Availability

100 ft (30.5 m)
500 ft (152 m)
1000 ft (305 m)
Bulk, cut to length

Hook-Up Wire

Type TGGT High-Temperature
600 V, PTFE/Glass Braid

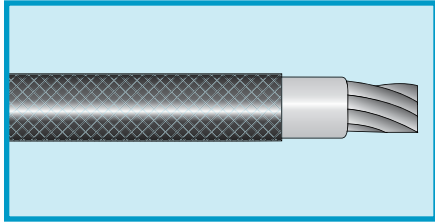

UL AWM 5196, 5251
CSA AWM 1 A/B

Operating Temperature

- -55°C to +250°C

Materials

- Flexible nickel-covered stranded copper conductor
- White PTFE tape insulation
- Tan high-temperature-saturant-coated glass braid jacket

Availability

100 ft (30.5 m)
500 ft (152 m)
1000 ft (305 m)
Bulk, cut to length

Part No.	Wire Size		Stranding		Insulation Thickness		Nominal Diameter	
	AWG	mm ²	AWG	mm	Inch	mm	Inch	mm
M70562*	2	36.6	133/0.0223	133 x 0.57	0.020	0.51	0.445	11.30
M70563	1	41.1	259/0.0177	259 x 0.45	0.020	0.51	0.485	12.32
M70564	1/0	53.5	259/0.0202	259 x 0.51	0.020	0.51	0.535	13.59
M70565	2/0	68.8	259/0.0227	259 x 0.58	0.020	0.51	0.685	17.40
M70566	3/0	85.3	259/0.0255	259 x 0.65	0.020	0.51	0.645	16.38
M70567	4/0	107	259/0.0286	259 x 0.73	0.020	0.51	0.710	18.03

*UL AWM 5196.

Hook-Up Wire

Welding Cable
600 V, EPDM

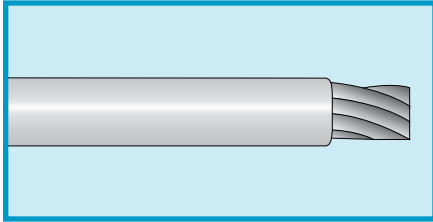

Operating Temperature

- -50°C to +105°C

Materials

- Stranded bare copper conductor
- Black EPDM rubber jacket

Availability

Bulk, cut to length

Part No.	Wire Size		Stranding		Insulation Thickness		Nominal Diameter		Current-Carrying Capacity	Voltage Drop*
	AWG	mm ²	AWG	mm	Inch	mm	Inch	mm	A	V
6112	6	13.5	266/30	266 x 0.25	0.060	1.52	0.320	8.13	75	3.30
6113	4	19.9	392/30	392 x 0.25	0.060	1.52	0.375	9.53	100	2.80
6115	2	32.6	644/30	644 x 0.25	0.060	1.52	0.440	11.18	200	3.60
6116	1	39.7	784/30	784 x 0.25	0.080	2.03	0.515	13.08	250	3.80
6117	1/0	52.0	1026/30	1026 x 0.25	0.080	2.03	0.550	13.97	300	3.60
6118	2/0	63.5	1254/30	1254 x 0.25	0.080	2.03	0.590	14.99	375	3.37
6119	3/0	81.8	1615/30	1615 x 0.25	0.080	2.03	0.660	16.76	450	3.40
6120	4/0	104	2056/30	2056 x 0.25	0.080	2.03	0.725	18.42	550	3.30

*Voltage drop per 100 ft (30.5 m) at 60°C.



Hook-Up Wire

1000/2000 V Photovoltaic Wire, XLPE, PVC

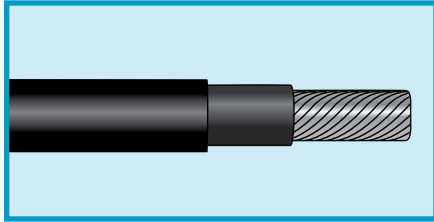

UL 4703 PV VW-1 (2000 V)
UL Sunlight Resistant

Operating Temperature

- -40°C to +90°C

Materials

- Stranded tinned copper conductor
- Black cross-linked polyethylene insulation
- Black PVC jacket

Availability

100 ft (30.5 m)
1000 ft (305 m)

Part No.	Wire Size		Stranding		Insulation/Jacket Thickness		Nominal Diameter	
	AWG	mm ²	AWG	mm	Inch	mm	Inch	mm
PV1430	14	2.08	41/30	41 x 0.25	0.063/ 0.032	1.60/ 0.81	0.267	6.78
PV1230	12	3.29	65/30	65 x 0.25	0.063/ 0.032	1.60/ 0.81	0.286	7.26
PV1030	10	5.32	105/30	105 x 0.25	0.063/ 0.032	1.60/ 0.81	0.311	7.90
PV0830A*	8	8.51	168/30	168 x 0.25	0.078/ 0.032	1.98/ 0.81	0.390	9.91
PV0630A*	6	13.5	266/30	266 x 0.25	0.078/ 0.032	1.98/ 0.81	0.433	11.00
PV0430A*	4	21.3	420/30	420 x 0.25	0.078/ 0.032	1.98/ 0.81	0.491	12.47
PV0230A*	2	33.7	665/30	665 x 0.25	0.078/ 0.032	1.98/ 0.81	0.558	14.17

*UL 4703 PV only.

Hook-Up Wire

600/1000 V Photovoltaic Wire, LSZH, LSZH

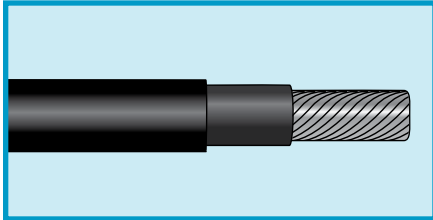

UL 4703 PV VW-1 (600 V)
UL Sunlight Resistant
TÜV 2 PFG 1169 (1000 V)
IEC 60332-1
IEC 60754-1 and 60754-2

Operating Temperature

- -40°C to +125°C
- -40°C to +90°C (TÜV and UL)
- +120°C maximum temperature at conductor (TÜV)

Materials

- Stranded tinned copper conductor
- Black cross-linked LSZH insulation
- Black cross-linked LSZH jacket

Availability

100 ft (30.5 m)
 1000 ft (305 m)

Part No.	Wire Size		Stranding		Insulation/Jacket Thickness		Nominal Diameter	
	AWG	mm ²	AWG	mm	Inch	mm	Inch	mm
PVT1430	14	2.5	50/30	50 x 0.25	0.045/ 0.032	1.14/ 0.81	0.230	5.84
PVT1228	12	4.0	56/28	56 x 0.32	0.045/ 0.032	1.14/ 0.81	0.252	6.40
PVT1028	10	6.0	84/28	84 x 0.32	0.045/ 0.032	1.14/ 0.81	0.275	6.99
PVT0826	8	10	78/26	78 x 0.40	0.060/ 0.032	1.52/ 0.81	0.340	8.64
PVT0626	6	16	128/26	128 x 0.40	0.060/ 0.032	1.52/ 0.81	0.386	9.80
PVT0426	4	25	199/26	199 x 0.40	0.060/ 0.032	1.52/ 0.81	0.436	11.07
PVT0226	2	35	279/26	279 x 0.40	0.060/ 0.032	1.52/ 0.81	0.484	12.29



Hook-Up Wire

EcoWire™
600 V, mPPE

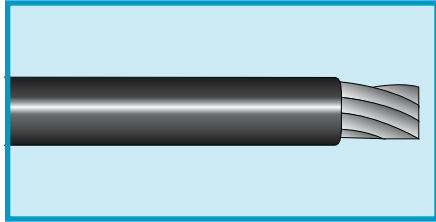

Innovative EcoWire combines increased performance with a minimized environmental impact. EcoWire's modified polyphenylene ether (mPPE) insulation is inherently lighter, tougher, and more durable than PVC. The result is UL AWM wire that is up to 45% smaller in diameter and

40% lighter than PVC-based counterparts, while offering 10x better abrasion resistance. Plus, the non-halogenated insulation contains no heavy metal pigments, allowing it to help manufacturers meet Waste Electrical and Electronic Equipment (WEEE) requirements.

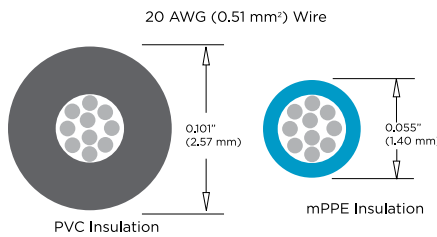

**UL AWM 11028 VW-1
CSA AWM I A/B FT1
CE compliant**

Operating Temperature

- -40°C to +105°C

Materials

- Stranded or solid tinned copper conductors
- Modified polyphenylene ether insulation

Availability

- 100 ft (30.5 m)
- 1000 ft (305 m)

Part No.	Conductor Size		Stranding		Insulation Thickness		Wire Diameter	
	AWG	mm ²	AWG	mm	Inch	mm	Inch	mm
6710	28	0.07	7/36	7 x 0.12	0.010	0.25	0.034	0.86
6711	26	0.14	7/34	7 x 0.16	0.010	0.25	0.038	0.97
6712	24	0.22	7/32	7 x 0.20	0.010	0.25	0.043	1.09
6713	22	0.35	7/30	7 x 0.25	0.010	0.25	0.049	1.24
6714	20	0.51	10/30	10 x 0.25	0.010	0.25	0.055	1.40
6715	18	0.81	16/30	16 x 0.25	0.010	0.25	0.067	1.70
6715S	18	0.82	Solid	Solid	0.010	0.25	0.059	1.50
6716	16	1.32	26/30	26 x 0.25	0.011	0.28	0.081	2.06
6717	14	2.09	41/30	41 x 0.25	0.011	0.28	0.096	2.44
6717S	14	2.08	Solid	Solid	0.011	0.28	0.086	2.18
6718	12	3.31	65/30	65 x 0.25	0.012	0.30	0.117	2.97
6719	10	5.37	105/30	105 x 0.25	0.012	0.30	0.144	3.66

White	Yellow	Slate
Black	Blue	Violet
Red	Brown	Green/Yellow
Green	Orange	



Hook-Up Wire

150/600 V Ribbon Cable, PVC

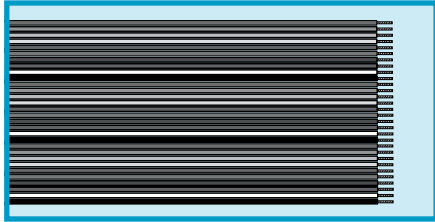

**MIL-DTL-16878/1 (Type B)
(600 V)
UL AWM 2713 (150 V) VW-1**

Operating Temperature

- -20°C to +105°C (MIL)
- -20°C to +80°C (AWM)

Conductor Color Coding

- Brown, red, orange, yellow, green, blue, violet, slate, white, black . . . repeats

Materials

- Stranded tinned copper conductors
- Color-coded PVC insulation bonded into a flat configuration

Availability

100 ft (30.5 m)

26 AWG (0.14 mm²)

Stranding: 7/34 (7 x 0.16 mm)
Insulation thickness: 0.010 (0.25 mm)
Cable height: 0.039 (0.99 mm)

Part No.	Conductors	Width	
		Inch	mm
3550	10	0.392	9.96
3550/14	14	0.546	13.87
3551	15	0.585	14.68
3551/16	16	0.624	15.85
3553	30	1.170	29.72

24 AWG (0.23 mm²)

Stranding: 7/32 (7 x 0.20 mm)
Insulation thickness: 0.010 (0.25 mm)
Cable height: 0.044 (1.12 mm)

Part No.	Conductors	Width	
		Inch	mm
3540/7	10	0.440	11.18
3541/7	15	0.660	16.76
3542/7	20	0.880	22.35

24 AWG (0.24 mm²)

Stranding: 19/36 (19 x 0.12 mm)
Insulation thickness: 0.010 (0.25 mm)
Cable height: 0.044 (1.12 mm)

Part No.	Conductors	Width	
		Inch	mm
3540	10	0.440	11.18
3541	15	0.660	16.76
3542	20	0.880	22.35
3543	30	1.320	33.53

22 AWG (0.35 mm²)

Stranding: 7/30 (7 x 0.25 mm)
Insulation thickness: 0.010 (0.25 mm)
Cable height: 0.050 (1.27 mm)

Part No.	Conductors	Width	
		Inch	mm
3530/7	10	0.500	12.70
3531/7	15	0.750	19.05
3532/7	20	1.000	25.40
3533/7	30	1.500	38.10

22 AWG (0.38 mm²)

Stranding: 19/34 (19 x 0.16 mm)
Insulation thickness: 0.010 (0.25 mm)
Cable height: 0.051 (1.29 mm)

Part No.	Conductors	Width	
		Inch	mm
3530	10	0.510	12.95
3531	15	0.765	19.43
3532	20	1.020	25.91
3533	30	1.530	38.86



Hook-Up Wire

300/1000 V Ribbon Cable, PVC

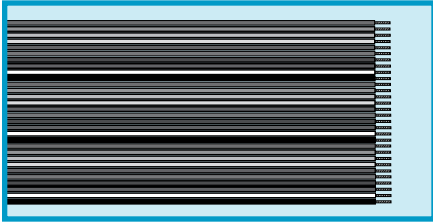

**MIL-DTL-16878/2 (Type C)
(1000 V)
UL AWM 2555 (300 V)**

Operating Temperature

- -20°C to +105°C (MIL)
- -20°C to +80°C (AWM)

Conductor Color Coding

- Brown, red, orange, yellow, green, blue, violet, slate, white, black . . . repeats

Materials

- Stranded tinned copper conductors
- Color-coded PVC insulation bonded into a flat configuration

Availability

100 ft (30.5 m)

22 AWG (0.35 mm²)

Stranding: 7/30 (7 x 0.25 mm)
Insulation thickness: 0.016 (0.41 mm)
Cable height: 0.065 (1.65 mm)

Part No.	Conductors	Width	
		Inch	mm
3505	5	0.310	7.87
3510	10	0.620	15.75
3515	15	0.930	23.62
3520	20	1.240	31.50

Hook-Up Wire

Bus Bar Wire

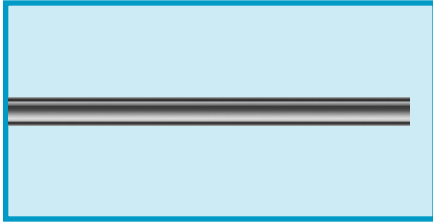

CID AA-59551 Type S ASTM B33

Material

- Electrolytic soft-drawn and annealed solid tin-plated copper conductor

Availability

100 ft (30.5 m)
1000 ft (305 m)

Part No	Wire Size			Diameter	
	AWG	CMA	mm ²	Inch	mm
938	38	16	.008	0.004	0.10
936	36	25	0.01	0.005	0.13
934	34	40	0.02	0.006	0.15
932	32	64	0.03	0.008	0.20
299/3	30	100	0.05	0.010	0.25
299/2	28	159	0.08	0.013	0.33
299/1	26	253	0.12	0.016	0.41
299	24	404	0.20	0.020	0.51
298	22	640	0.32	0.025	0.64
297	20	1020	0.51	0.032	0.81
296	18	1620	0.82	0.040	1.02
295	16	2580	1.31	0.051	1.30
286	14	4110	2.08	0.064	1.63
289	12	6530	3.31	0.081	2.06
910	10	10380	5.26	0.102	2.59
908	8	16510	8.37	0.129	3.28
906	6	26250	13.3	0.162	4.11



Hook-Up Wire Kits



Alpha's hook-up wire kits contain an assortment of 100 ft (30.5 m) spools of hook-up wire suitable for military or UL/CSA applications. These kits have been designed for use by technicians, engineers, and designers in the R&D lab or maintenance shop. Each kit contains a stripping tool and five spools of hook-up wire in a unique, rack-mounted, transparent dispensing tube. The tube and rack system keeps hook-up wire neat, clean, and conveniently at hand.

Operating Temperature

- -40°C to +80°C (HU-KIT-10, 30)
- -40°C to +105°C (HU-KIT-20, 40)

Voltage Rating

- 1000 V (HU-KIT-10, 30)
- 300 V (HU-KIT-20, 40)

Materials

- Stranded tinned copper conductor
- Color-coded PVC insulation

Availability

1 box

Part No.	Wire Type	Wire Size		Colors	Wire Length (each order)		Reorder No.
		AWG	mm ²		Feet	Meters	
HU-KIT-40	UL AWM 1007 UL AWM 1569 CSA TR 64	24	0.23	White	100	30.5	3050
				Black			
				Red			
				Green			
	Blue						
HU-KIT-30	MIL-W-76B Type MW	24	0.23	White	100	30.5	1550
				Black			
				Red			
				Green			
	Blue						
HU-KIT-20	UL AWM 1007 UL AWM 1569 CSA TR 64	22	0.36	White	100	30.5	3051
				Black			
				Red			
				Green			
	Blue						
HU-KIT-10	MIL-W-76B Type MW	22	0.36	White	100	30.5	1551
				Black			
				Red			
				Green			
	Blue						

Note: Each kit includes a cut-and-strip tool.

Dearborn™ Bulk Hook-Up Wire

We support your high-volume needs with large put-ups for a wide range of both military and UL style PVC hook-up wire.

Dearborn bulk wire has the same high quality as all Alpha wire and cable, but is available in put-ups of 5000 ft (1524 m) and above. Many styles are available in barrel packs as well.

Bulk PVC wire options include:

- Stranded and solid conductors
- Bare or tinned copper
- Standard and semirigid PVC
- Variety of temperature ranges

Popular Bulk Wire Styles

Style	Insulation	AWG Range	Temperature
MIL-DTL-16878/1 (Type B)	PVC	32 - 14	-55°C to +105°C
MIL-DTL-16878/2 (Type C)	PVC	24 - 22	-55°C to +105°C
MIL-DTL-16878/3 (Type D)	PVC	16	-20°C to +105°C
MIL-W-76 Type MWP	PVC	24, 12	-55°C to +90°C
UL AWM 1007	PVC	24 - 10	-20°C to +80°C
UL AWM 1028	PVC	24 - 10	-20°C to +105°C
UL AWM 1061	SR-PVC	30 - 20	-10°C to +80°C
UL AWM 1231	PVC	24 - 10	-20°C to +105°C
UL AWM 1569	PVC	28 - 16	-20°C to +105°C
UL AWM 1581	PVC	28 - 16	-20°C to +80°C
UL MTW	PVC	20 - 10	-20°C to +90°C
UL TW	PVC	24 - 10	-20°C to +60°C

For more styles and conductor options please contact your Alpha Wire Sales Representative.

{ C O N F E S S I O N }

We think we're pretty tough

(New EcoWire™ has 10x better abrasion and pinch resistance than PVC)

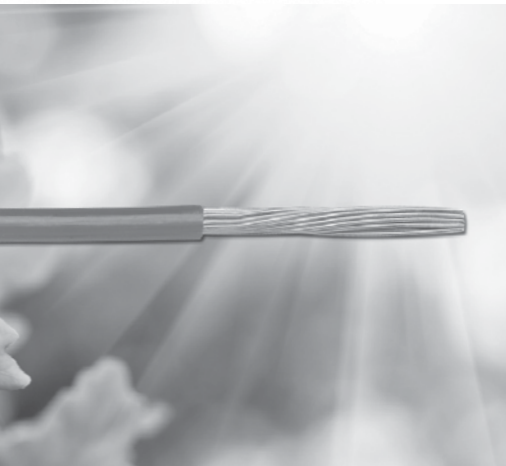

Superior Performance for Sustainable Designs

Tough wire doesn't have to be bulky or hard to recycle. Innovative EcoWire combines increased performance with a minimized environmental impact. EcoWire's modified polyphenylene ether (mPPE) insulation is inherently lighter, tougher, and more durable than PVC.

Meet Waste Electrical and Electronic Equipment (WEEE) requirements with EcoWire. Its nonhalogenated insulation contains no heavy metal pigments, so it is easily and 100% recyclable.

With sizes ranging from 28 to 10 AWG in a UL AWM 11028 style with a temperature range from -40°C to +105°C, EcoWire is the perfect hook-up wire where space savings, lighter weight, mechanical ruggedness, and

recyclability are required. And it gives you greener performance in eleven insulation colors.

Learn more about EcoWire by visiting www.alphawire.com to download a brochure and white paper, obtain complete specifications, or order a sample.

EcoWire Gives You More for Less

- 10x superior abrasion resistance
- Up to 45% smaller diameter
- Up to 40% lighter weight
- UL VW-1 flammability rating
- 100% recyclable

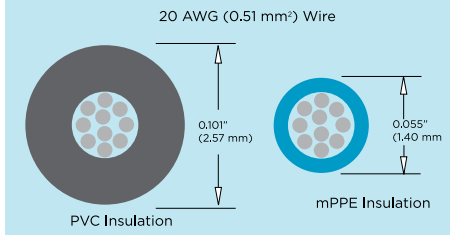

Cables you trust. Service you deserve.

Toll Free: 1-800-52 ALPHA | www.alphawire.com

C A B L E | W I R E | A C C E S S O R I E S

Dearborn™ Marine



Dearborn™ Marine

The Premier Choice for Marine Applications



For tough, seaworthy wire and cable, Alpha Wire's Dearborn brand of products delivers performance in the most challenging environments for electrical components and electronic systems, with the ever-present potential for corrosion and other harmful effects from moisture, salt, oil, and gases.

Whether you are building new pleasure or commercial watercraft or maintaining existing boats, our marine products will satisfy your most stringent requirements.

Complete line for every marine application

From wiring of engines, batteries, and bilge pumps to cables for communications, instrumentation, and electronics, you will find the exact wire or cable you need. Cables are color-coded to meet boating industry standards.

Marine wire

High-grade marine wire for the full spectrum of marine applications, including wiring of engines, batteries, and bilge pumps.

Marine cable

A complete line of multi-conductor cables, designed specifically for marine environments. Ideally suited for multiple applications, including communications, instrumentation, and electronics.

Marine heat-shrink tubing

To protect cable terminations and provide a watertight connection, we offer marine grade heat-shrink tubing with an operating temperature range of -55°C to +130°C for protecting electrical connections, and spiral wrap and split ducts for managing and organizing wires and cables.

Marine ready

Our cables meet various specifications to ensure regulatory compliance and seaworthiness:

- **UL Standard 1426: Electrical Cable for Boats**
- **SAE J378: Marine Propulsion Systems Wiring**
- **SAE J1127: Low-Voltage Battery Cables**
- **SAE J1128: Low-Voltage Primary Cables**
- **ABYC E-11-2008: Standard for AC and DC Electrical Systems on Boats**
- **ABYC E-10-2006: Storage Batteries**
- **USCG: Title 33, CFR 183 Subpart I, Section 183**

Designed to perform

Dearborn marine wire and cable use corrosion-resistant annealed tinned copper conductors with Type 3 marine stranding for extra flexibility and service life. A choice of round or flat multiconductor cables means easier handling and routing.

- **Rugged PVC insulation and jackets, rated to 105°C**
- **Easy circuit identification with color-coded conductors**
- **Shielded cable available for EMI protection**
- **UL VW-1 flame retardant**
- **Convenient, easy to use packaging in lengths as low as 50 feet**
- **Resistant to oil, chemicals, solvents, and sea water**
- **Premium high-performance with tinned conductors**

The Premier Choice for Marine Applications

Application	Configuration	No. of Conductors	Wire Gauge Range	Features
Engine wiring	Flat (parallel) or round	1 - 3	18 - 6	Color-coded with white jackets
Battery	Round	1	8 - 4/0	Extra flexible stranding
Speaker cable	Round	1	22 - 14	Ripcord construction
Bonding cable	Round	1	6 - 4	Resists oil, fungus, chemicals, and heat Retards electrolytic corrosion
Telephone cable	Round	2 - 3	22	High-density polyethylene insulation
Communications and control	Round	2 - 7	18 - 16	Shielded and unshielded
RFI shielded cable	Round	2 - 3	18 - 14	Foil shield, 100% coverage
Duplex shielded cable	Round	2	16 - 10	Foil + braid for maximum shielding
Bilge pump	Round	3	18 - 14	Water-resistant construction Resistant to gasoline, oils, solvents, and salt water
Trailer cable	Flat (parallel) or round	3 - 4	16 - 12	See-through insulation for easier installation

Required Marine Wiring Color Codes

Direct Current Systems, Under 50 Volts	
Color	Use
Green	Bonding
White or Black	Return, negative main
Red	Positive mains, particularly unfused

Notes: (1) The colors shall be reserved for the uses as indicated, only.
 (2) When the color (White or Black) is selected for the negative side of the system, it shall be used throughout the system to the exclusion of the other color.

Recommended Marine Wiring Color Codes

Direct Current Systems, Under 50 Volts		
Color	Item	Use
Yellow w/Red Stripe	Starting circuit	Starting switch to solenoid
Yellow	Generator or alternator field	Generator or alternator field to regulator field
	Bilge blowers	Terminal fuse or switch to blowers
Dark Gray	Navigation lights	Fuse or switch to lights
	Tachometer	Tachometer sender to gauge
Brown	Generator armature	Generator armature to regulator
	Alternator charge light	Generator terminal or alternator auxiliary terminal to light to regulator
	Pumps	Fuse or switch to pumps
Orange	Accessory feed	Ammeter to alternator or generator output and accessory fuses or switches
	Accessory common feed	Distribution panel to accessory switch
Purple	Ignition	Ignition switch to coil and electrical instruments
	Instrument feed	Distribution panel to electric instruments
Dark Blue	Cabin and instrument lights	Fuse or switch to lights
Light Blue	Oil pressure	Sender to gauge
Tan	Water temperature	Water temperature sender to gauge
Pink	Fuel gauge	Fuel gauge sender to gauge

Dearborn™ Marine Wire

50 V Standard-Grade Primary Wire

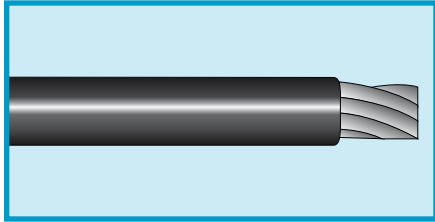

**SAE J1128 Type GPT
SAE J378B**

Part No.	Wire Size		Stranding		Insulation Thickness		Nominal Diameter	
	AWG	mm ²	AWG	mm	Inch	mm	Inch	mm
PWM1816	18	0.81	16/30	16 x 0.25	0.023	0.58	0.093	2.36
PWM1619	16	1.23	19/29	19 x 0.29	0.023	0.58	0.103	2.62
PWM1419	14	1.94	19/27	19 x 0.36	0.023	0.58	0.117	2.97
PWM1219	12	3.08	19/25	19 x 0.46	0.026	0.66	0.142	3.61
PWM1019	10	4.92	19/23	19 x 0.57	0.034	0.86	0.176	4.47
PWM0819	8	7.82	19/21	19 x 0.72	0.037	0.94	0.216	5.49
PWM0619	6	12.4	19/19	19 x 0.91	0.043	1.09	0.337	8.56

Operating Temperature

- -40°C to +105°C

Insulation Color Coding

- Black, red, orange, yellow, green, blue, violet, white, brown, slate

Materials

- Stranded bare copper conductors
- PVC insulation

Availability

100 ft (30.5 m)

500 ft (152 m)

1000 ft (305 m)

Bulk, cut to length

(Minimums may apply)



Dearborn™ Marine Wire

600 V Premier Battery Wire

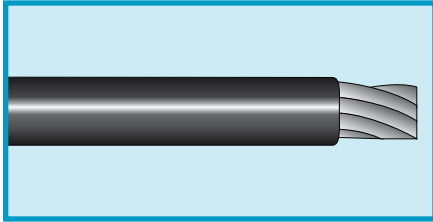

UL AWM 1283 VW-1
UL BC-5W2
UL Oil Res 1
CSA AWM I A/B FT1
CSA TEW-105
ABYC
Coast Guard
SAE J378B, J1127 Type SGT
(50 V)

Part No.	Wire Size		Stranding		Insulation Thickness		Nominal Diameter	
	AWG	mm ²	AWG	mm	Inch	mm	Inch	mm
PBM0830	8	8.51	168/30 (7 x 24)	168 x 0.25	0.060	1.52	0.294	7.47
PBM0630	6	13.5	266/30 (7 x 38)	266 x 0.25	0.060	1.52	0.339	8.61
PBM0430	4	21.3	420/30 (7 x 60)	420 x 0.25	0.065	1.65	0.404	10.26
PBM0230	2	33.7	665/30 (7 x 95)	665 x 0.25	0.065	1.65	0.471	11.96
PBM0130	1	42.4	836/30 (19 x 44)	836 x 0.25	0.082	2.08	0.529	13.44
PBM0001	1/0	53.9	1064/30 (19 x 56)	1064 x 0.25	0.082	2.08	0.570	14.48
PBM0002	2/0	67.0	1323/30 (7 x 7 x 27)	1323 x 0.25	0.082	2.08	0.648	16.46
PBM0003	3/0	84.4	1666/30 (7 x 7 x 34)	1666 x 0.25	0.082	2.08	0.659	16.74
PBM0004	4/0	107	2109/30 (37 x 57)	2109 x 0.25	0.082	2.08	0.760	19.30

Operating Temperature

- -20°C to +105°C

Insulation Color Coding

- White, black, red, green, yellow, blue, brown, orange, slate, violet

Materials

- Corrosion-resistant stranded tinned copper conductors
- PVC insulation

Availability

100 ft (30.5 m)
 500 ft (152 m)
 1000 ft (305 m)
 (Minimums may apply)



Dearborn™ Marine Wire

600 V Premier Primary Wire

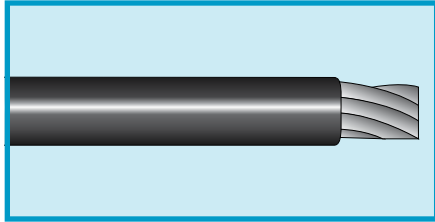

Part No.	Wire Size		Stranding		Insulation Thickness		Nominal Diameter	
	AWG	mm ²	AWG	mm	Inch	mm	Inch	mm
PPM1830	18	0.81	16/30	16 x 0.25	0.031	0.79	0.109	2.77
PPM1630	16	1.32	26/30	26 x 0.25	0.031	0.79	0.122	3.10
PPM1430	14	2.08	41/30	41 x 0.25	0.031	0.79	0.136	3.45
PPM1230	12	3.29	65/30	65 x 0.25	0.032	0.81	0.152	3.86
PPM1030	10	5.32	105/30	105 x 0.25	0.032	0.81	0.185	4.67
PPM0830	8	8.51	168/30 (7 x 24)	168 x 0.25	0.032	0.81	0.232	5.89

- UL AWM 1015 VW-1**
- UL AWM 1230**
- UL Oil Res. 1**
- UL BC-5W2**
- CSA AWM I A/B FT1**
- CSA TEW-105**
- SAE J1128 Type GPT**
- SAE J378B**
- ABYC**
- Coast Guard**

Operating Temperature

- -20°C to +105°C

Insulation Color Coding

- White, black, red, green, yellow, blue, brown, orange, slate, violet

Materials

- Corrosion-resistant stranded tinned copper conductors
- PVC insulation

Availability

- 100 ft (30.5 m)
 - 500 ft (152 m)
 - 1000 ft (305 m)
- (Minimums may apply)



Dearborn™ Marine Wire

600 V Bonding Marine Wire

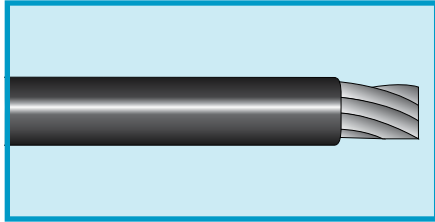

Part No.	Wire Size		Stranding		Insulation Thickness		Nominal Diameter	
	AWG	mm ²	AWG	mm	Inch	mm	Inch	mm
PGM0849	8	8.42	49/0.0184 (7 x 7)	49 x 0.47	0.060	1.52	0.286	7.26
PGM0649	6	13.3	49/0.0231 (7 x 7)	49 x 0.59	0.060	1.52	0.328	8.33
PGM0449	4	21.2	49/0.0292 (7 x 7)	49 x 0.74	0.065	1.65	0.393	9.98

- UL AWM 1028**
- UL BC-5W2**
- UL VW-1**
- UL Oil Res I**
- CSA AWM I A/B FT1**
- CSA TEW-105**
- SAE J1128**

Operating Temperature

- -20C to +105°C (dry)
- -20C to +60°C (wet or oil)

Insulation Color Coding

- Green

Materials

- Corrosion-resistant stranded tinned copper conductors
- PVC insulation

Availability

- 100 ft (30.5 m)
- 500 ft (152 m)
- 1000 ft (305 m)
- Bulk, cut to length**
- (Minimums may apply)



Dearborn™ Marine Cable

600 V Unshielded, Multiconductor, Premier Duplex Cable

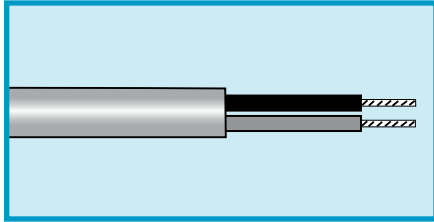

UL BC 5W2
UL Oil Res. I
UL VW-1

Operating Temperature

- -20°C to +105°C (dry)
- -20°C to +75°C (wet)

Conductor Color Coding

- 1 Black, 2 Red

Materials

- Corrosion-resistant stranded tinned copper conductors
- White PVC insulation

Availability

100 ft (30.5 m)
 500 ft (152 m)
 1000 ft (305 m)

(Minimums may apply)

Two-Conductor Cable

Part No.	Wire Size		Stranding		Insulation Thickness		Jacket Thickness		Cable Dimension	
	AWG	mm ²	AWG	mm	Inch	mm	Inch	mm	Inch	mm
PDM2002	20	0.50	10/30	10 x 0.25	0.032	0.81	0.035	0.89	0.161 x 0.260	4.09 x 6.60
PDM1802	18	0.81	16/30	16 x 0.25	0.032	0.81	0.035	0.89	0.181 x 0.292	4.60 x 7.42
PDM1602	16	1.32	26/30	26 x 0.25	0.032	0.81	0.035	0.89	0.194 x 0.318	4.93 x 8.33
PDM1402	14	2.08	41/30	41 x 0.25	0.032	0.81	0.035	0.89	0.208 x 0.346	5.28 x 8.79
PDM1202	12	3.29	65/30	65 x 0.25	0.032	0.81	0.035	0.89	0.227 x 0.384	5.77 x 9.75
PDM1002	10	5.32	105/30	105 x 0.25	0.032	0.81	0.035	0.89	0.252 x 0.434	6.40 x 11.02
PDM0802	8	8.51	168/30	168 x 0.25	0.048	1.22	0.035	0.89	0.334 x 0.598	8.48 x 15.19
PDM0602	6	13.5	266/30	266 x 0.25	0.060	1.52	0.035	0.89	0.403 x 0.736	10.24 x 18.69



Dearborn™ Marine Cable

600 V Unshielded, Multiconductor, Premier Duplex Safety Cable

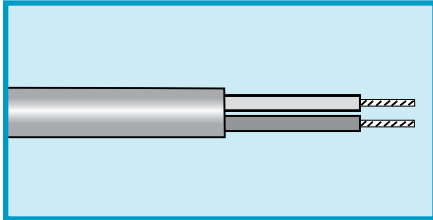

UL BC 5W2
UL Oil Res. I
UL VW-1

Operating Temperature

- -20°C to +105°C (dry)
- -20°C to +75°C (wet)

Conductor Color Coding

- 1 Yellow, 2 Red

Materials

- Corrosion-resistant stranded tinned copper conductors
- White PVC insulation

Availability

100 ft (30.5 m)
500 ft (152 m)

(Minimums may apply)

Two-Conductor Cable

Part No.	Wire Size		Stranding		Insulation Thickness		Jacket Thickness		Cable Dimension	
	AWG	mm ²	AWG	mm	Inch	mm	Inch	mm	Inch	mm
PDS1802	18	0.81	16/30	16 x 0.25	0.032	0.81	0.035	0.89	0.280 x 0.172	7.11 x 4.37
PDS1602	16	1.32	26/30	26 x 0.25	0.032	0.81	0.035	0.89	0.322 x 0.194	8.18 x 4.93
PDS1402	14	2.08	41/30	41 x 0.25	0.032	0.81	0.035	0.89	0.356 x 0.211	9.04 x 5.36
PDS1202	12	3.29	65/30	65 x 0.25	0.032	0.81	0.035	0.89	0.392 x 0.230	9.96 x 5.84
PDS1002	10	5.32	105/30	105 x 0.25	0.032	0.81	0.035	0.89	0.450 x 0.250	11.43 x 6.35
PDS0802	8	8.51	168/30	168 x 0.25	0.048	1.22	0.035	0.89	0.608 x 0.336	15.44 x 8.53
PDS0602	6	13.50	266/30	266 x 0.25	0.060	1.52	0.035	0.89	0.750 x 0.420	19.05 x 10.67



Dearborn™ Marine Cable

600 V Unshielded, Multiconductor, Premier Triplex Cable

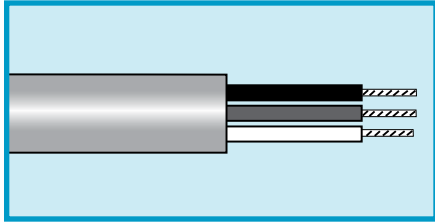

UL BC 5W2
UL Oil Res. I
UL VW-1

Operating Temperature

- -20°C to +105°C (dry)
- -20°C to +75°C (wet)

Conductor Color Coding

- 1 Black (ungrounded)
- 2 Green (ground)
- 3 White (ground neutral)

Materials

- Corrosion-resistant stranded tinned copper conductors
- White PVC insulation

Availability

- 100 ft (30.5 m)
 - 500 ft (152 m)
 - 1000 ft (305 m)
- (Minimums may apply)

Three-Conductor Cable

Part No.	Wire Size		Stranding		Insulation Thickness		Jacket Thickness		Cable Dimension	
	AWG	mm ²	AWG	mm	Inch	mm	Inch	mm	Inch	mm
PFM1603	16	1.32	26/30	26 x 0.25	0.032	0.81	0.035	0.89	0.194 x 0.442	4.93 x 11.23
PFM1403	14	2.08	41/30	41 x 0.25	0.032	0.81	0.035	0.89	0.208 x 0.484	5.28 x 12.29
PFM1203	12	3.29	65/30	65 x 0.25	0.032	0.81	0.035	0.89	0.227 x 0.541	5.77 x 13.74
PFM1003	10	5.32	105/30	105 x 0.25	0.032	0.81	0.035	0.89	0.252 x 0.616	6.40 x 15.65
PFM0803	8	8.51	168/30	168 x 0.25	0.048	1.22	0.035	0.89	0.302 x 0.766	7.67 x 19.46
PFM0603	6	13.50	266/30	266 x 0.25	0.060	1.52	0.035	0.89	0.379 x 0.997	9.63 x 25.32



Dearborn™ Marine Cable

600 V Unshielded, Multiconductor, Premier Round Cable

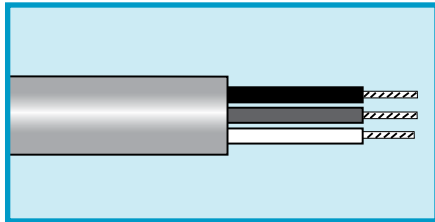

UL BC 5W2
UL Oil Res. I
UL VW-1

Operating Temperature

- -20°C to +105°C (dry)
- -20°C to +75°C (wet)

Conductor Color Coding

- Two-Cond. Cable: 1 Black, 2 Red
- Three-Cond. Cable: 1 White, 2 Black, 3 Green
- Four-Cond. Cable: 1 White, 2 Black, 3 Green, 4 Red

Materials

- Corrosion-resistant stranded tinned copper conductors
- PVC insulation
- White PVC jacket

Availability

- 100 ft (30.5 m)
- 500 ft (152 m)
- 1000 ft (305 m)

Part No.	Conductors	Wire Size		Stranding		Insulation Thickness		Jacket Thickness		Nominal Diameter	
		AWG	mm ²	AWG	mm	Inch	mm	Inch	mm	Inch	mm
PRM1602	2	16	1.32	26/30	26 x 0.25	0.032	0.81	0.035	0.89	0.324	8.23
PRM1603	3	16	1.32	26/30	26 x 0.25	0.032	0.81	0.035	0.89	0.344	8.74
PRM1604	4	16	1.32	26/30	26 x 0.25	0.032	0.81	0.035	0.89	0.376	9.55
PRM1402	2	14	2.08	41/30	41 x 0.25	0.032	0.81	0.035	0.89	0.352	8.94
PRM1403	3	14	2.08	41/30	41 x 0.25	0.032	0.81	0.035	0.89	9.374	9.50
PRM1404	4	14	2.08	41/30	41 x 0.25	0.032	0.81	0.035	0.89	0.410	10.41
PRM1202	2	12	3.29	65/30	65 x 0.25	0.032	0.81	0.035	0.89	0.390	9.91
PRM1203	3	12	3.29	65/30	65 x 0.25	0.032	0.81	0.035	0.89	0.415	10.54
PRM1204	4	12	3.29	65/30	65 x 0.25	0.032	0.81	0.035	0.89	0.456	11.58
PRM1002	2	10	5.32	105/30	105 x 0.25	0.032	0.81	0.035	0.89	0.400	10.16
PRM1003	3	10	5.32	105/30	105 x 0.25	0.032	0.81	0.035	0.89	0.469	11.91
PRM1004	4	10	5.32	105/30	105 x 0.25	0.032	0.81	0.035	0.89	0.517	13.13
PRM0803	3	8	8.51	168/30	266 x 0.25	0.048	1.22	0.035	0.89	0.646	16.41
PRM0804	4	8	8.51	168/30	266 x 0.25	0.048	1.22	0.035	0.89	0.716	18.19
PRM0603	3	6	13.5	266/30	266 x 0.25	0.060	1.52	0.035	0.89	0.794	20.17
PRM0604	4	6	13.5	266/30	266 x 0.25	0.061	1.55	0.035	0.89	0.888	22.56



Dearborn™ Marine Cable

600 V Unshielded, Multiconductor, Premier Clear Cote™ Cable

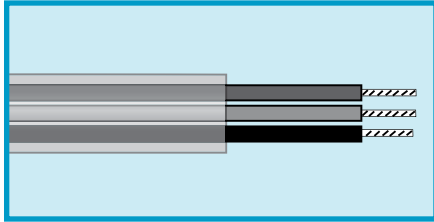

UL BC 5W2
UL Oil Res. I
UL VW-1
SAE J378B, J1128 Types GPT and HDT

Operating Temperature

- -20°C to +105°C (dry)
- -20°C to +75°C (wet)

Conductor Color Coding

- 1 Black, 2 Red, 3 Green

Materials

- Corrosion-resistant stranded tinned copper conductors
- PVC insulation
- Clear PVC jacket

Availability

- 100 ft (30.5 m)
 - 500 ft (152 m)
 - 1000 ft (305 m)
- (Minimums may apply)

Three-Conductor Round Cable

Part No.	Wire Size		Stranding		Insulation Thickness		Jacket Thickness		Nominal Diameter	
	AWG	mm ²	AWG	mm	Inch	mm	Inch	mm	Inch	mm
PCM1603R	16	1.32	26/30	26 x 0.25	0.032	0.81	0.035	0.89	0.292	7.42
PCM1403R	14	2.08	41/30	41 x 0.25	0.032	0.81	0.035	0.89	0.329	8.36
PCM1203R	12	3.29	65/30	65 x 0.25	0.032	0.81	0.035	0.89	0.370	9.40

Two-Conductor Parallel Cable

Part No.	Wire Size		Stranding		Insulation Thickness		Jacket Thickness		Nominal Size	
	AWG	mm ²	AWG	mm	Inch	mm	Inch	mm	Inch	mm
PCM1802	18	0.81	16/30	16 x 0.25	0.032	0.81	0.022	0.56	0.244 x 0.140	6.20 x 3.56
PCM1602	16	1.32	26/30	26 x 0.25	0.032	0.81	0.022	0.56	0.272 x 0.144	6.91 x 3.66
PCM1402	14	2.08	41/30	41 x 0.25	0.032	0.81	0.022	0.56	0.306 x 0.161	7.77 x 4.09
PCM1202	12	3.29	65/30	65 x 0.25	0.032	0.81	0.022	0.56	0.197 x 0.350	5.00 x 8.89
PCM1002	10	5.32	105/30	105 x 0.25	0.032	0.81	0.022	0.56	0.226 x 0.408	5.74 x 10.36
PCM0802	8	8.51	168/30	168 x 0.25	0.048	1.22	0.050	1.27	0.364 x 0.628	9.25 x 15.95



Dearborn™ Marine Cable

300 V Unshielded, Multiconductor, Premier Speaker Cable

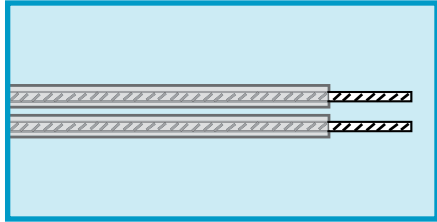

Operating Temperature

- -20°C to +60°C

Conductor Color Coding

- Clear

Materials

- Stranded copper conductors, one bar, one tinned
- PVC insulation

Availability

- 100 ft (30.5 m)
 - 500 ft (152 m)
 - 1000 ft (305 m)
- (Minimums may apply)

Two-Conductor Ripcord Cable

Part No.	Wire Size		Stranding		Insulation Thickness		Nominal Size	
	AWG	mm ²	AWG	mm	Inch	mm	Inch	mm
PAM1602	16	1.32	26/30	26 x 0.25	0.027	0.69	0.115 x 0.230	2.92 x 5.84
PAM1402	14	2.08	41/30	41 x 0.25	0.027	0.69	0.140 x 0.290	3.56 x 7.37



Dearborn™ Marine Cable

600 V Foil/Braid Shielded, Multiconductor, Duplex Cable

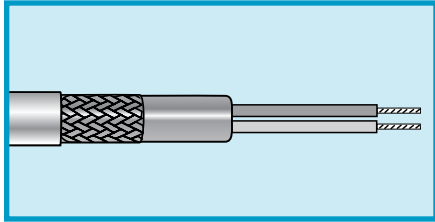

UL BC 5W2
UL VW-1

Operating Temperature

- -20°C to +105°C (dry)
- -20°C to +75°C (wet)

Conductor Color Coding

- 1 Yellow, 2 Red

Materials

- Corrosion-resistant stranded tinned copper conductors

- PVC insulation
- Foil + braid shield
Aluminum/polyester foil
Tinned copper braid
- White PVC jacket

Availability

- 100 ft (30.5 m)
 - 500 ft (152 m)
 - 1000 ft (305 m)
- (Minimums may apply)

Two-Conductor Cable

Part No.	Wire Size		Stranding		Insulation Thickness		Nominal Size	
	AWG	mm ²	AWG	mm	Inch	mm	Inch	mm
PSD1602	16	1.32	26/30	26 x 0.25	0.032	0.81	0.340	8.64
PSD1002	10	5.32	105/30	105 x 0.25	0.032	0.81	0.438	11.13



Dearborn™ Marine Cable

50 V Unshielded, Multiconductor, Bonded Duplex Primary Cable

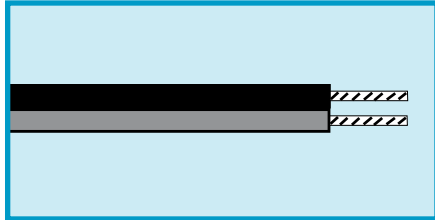

**SAE J1128 Type GPT
SAE J378B**

Operating Temperature

- -20°C to +105°C

Conductor Color Coding

- 1 Black, 2 Red

Materials

- Corrosion-resistant stranded bare copper conductors
- PVC insulation

Availability

100 ft (30.5 m)

500 ft (152 m)

1000 ft (305 m)

(Minimums may apply)

Part No.	Wire Size		Stranding		Insulation Thickness		Nominal Size	
	AWG	mm ²	AWG	mm	Inch	mm	Inch	mm
PWM1802B	18	0.81	16/0.009	16 x 0.23	0.023	0.58	0.094 x 0.189	2.39 x 4.80
PWM1602B	16	1.23	19/29	19 x 0.29	0.023	0.58	0.102 x 0.204	2.59 x 5.18
PWM1402B	14	1.94	19/27	19 x 0.36	0.023	0.58	0.117 x 0.235	2.97 x 5.97
PWM1202B	12	3.08	19/25	19 x 0.45	0.023	0.58	0.142 x 0.285	3.61 x 7.24
PWM1002B	10	4.92	19/23	19 x 0.57	0.023	0.58	0.176 x 0.353	4.47 x 8.97



Dearborn™ Marine Cable

600 V Unshielded, Multiconductor, Flat Bonded Trailer Cable

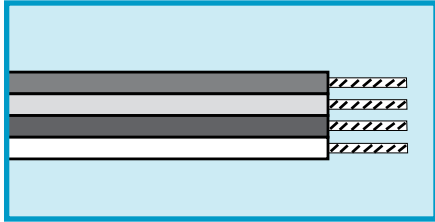

SAE J378/J1128 Type GPT

Operating Temperature

- -20°C to +105°C

Conductor Color Coding

- 1 Brown, 2 Yellow, 3 Green, 4 White

Materials

- Stranded bare copper conductors
- PVC insulation

Availability

100 ft (30.5 m)
Bulk, cut to length
 (Minimums may apply)

Part No.	Conductors	Wire Size		Stranding		Insulation Thickness		Nominal Size	
		AWG	mm ²	AWG	mm	Inch	mm	Inch	mm
PTB1603	3	16	1.23	19/29	19 x 0.29	0.023	0.58	0.013 x 0.309	2.62 x 7.85
PTB1604	4	16	1.23	19/29	19 x 0.29	0.023	0.58	0.103 x 0.412	2.62 x 10.46

Dearborn™ Marine Cable

600 V Unshielded, Multiconductor, Premier Round Trailer Cable

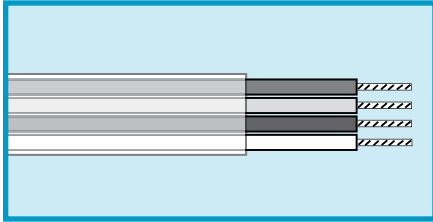

UL BC 5W2

Operating Temperature

- -20°C to +105°C

Conductor Color Coding

Conductor Colors

- 1 Brown, 2 Yellow, 3 Green, 4 White

Materials

- Corrosion-resistant stranded tinned copper conductors
- Clear PVC jacket

Availability

100 ft (30.5 m)

1000 ft (305 m)

Bulk, cut to length

(Minimums may apply)

Four-Conductor Cable

Part No.	Wire Size		Stranding		Insulation Thickness		Nominal Size	
	AWG	mm ²	AWG	mm	Inch	mm	Inch	mm
PTM1604	16	1.32	26/30	26 x 0.25	0.031	0.79	0.399	10.13
PTM1404	14	2.08	41/30	41 x 0.25	0.031	0.79	0.440	11.18



Market-Specific Solutions Sets



The Fast Track to Finding the Perfect Product

Find the wire, cable, and wire management products especially suited to your application with our market-specific solution sets. We've taken our expertise in different industries and applications and picked products that match specific application needs. You'll be able to find and specify products faster and easier.

Products in each solution set reflect the specific needs for electrical performance, durability under mechanical and environmental stresses, standards compliance, and all the other details that distinguish your application in such industries as:

- **Consumer goods**
- **Food and beverage**
- **Material handling**
- **Medical devices**
- **Military**
- **Industrial packaging**
- **Pharmaceutical**
- **Solar power**
- **Wind power**

Visit www.alphawire.com to find out more about our market specific solution sets.



Kerrigan-Lewis™ Specialty Wire

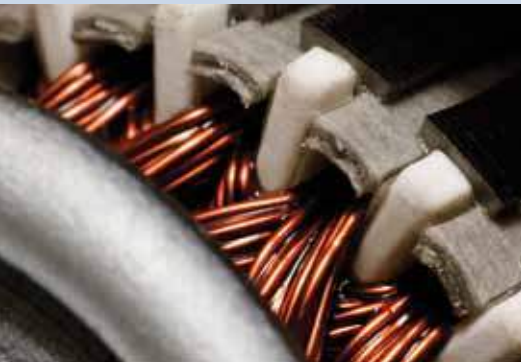

Kerrigan-Lewis™ Specialty Wire



Alpha Wire's Kerrigan-Lewis brand of specialty wire is designed and manufactured to stringent standards of quality and performance. From expertise in fine copper wire and insulations to an exact understanding of your most rigorous application requirements, we can help you increase efficiency, reduce size, and achieve higher levels of productivity.



We offer the lowest minimum order levels in the industry. Save money by ordering only what you need.

Our products are custom configured for specific applications. Call us at 773-772-7208 to discuss your application requirements for Kerrigan-Lewis specialty wire.

Litz wire

Litz wire reduces AC losses in conductors from skin and proximity effects at high frequencies to make transformers and motors more efficient. It consists of individually insulated strands woven or twisted in a specific pattern so that each tends to occupy all possible positions in the cross section. This equalizes flux linkages and reactances so that current is evenly divided among the strands for increased current-carrying efficiency.



Applications

- High-frequency inductors and transformers
- Motors
- Relays
- Inverters
- Power supplies
- Ultrasonic and sonar equipment
- Heat-induction equipment
- High-twist applications, up to 300 turns per foot

Kerrigan-Lewis litz wire is available in a wide range of configurations to meet specific operating frequencies, voltages, and current-carrying capacities. Individual strands range from 50 to 16 AWG, with anywhere from a few strands to thousands in the wire. Besides traditional round conductors, we also offer space-saving square and rectangular cross sections for maximum copper density.

Some popular configurations include:

- 60 strands of 36 AWG
- 100 strands of 38 AWG
- 2100 strands of 36 AWG

	Variations	Advantages
Insulations/Servings	NEMA-approved films	To 105°C, 155°C, 200°C Single and heavy coatings
	Cotton	To 105°C Abrasion resistant
	Nylon	To 130°C Abrasion resistant Good high-frequency properties
	Celanese synthetic yarn	To 105°C Excellent high-frequency properties Chemically soluble
	Nylon/Celanese mix	To 105°C Excellent high-frequency properties Chemically soluble
	Fluorocarbon textile	To 200°C Abrasion resistant Excellent high-frequency properties Excellent handling properties
	Teflon FEP extrusion	To 200°C Waterproof Abrasion resistant Excellent high-frequency properties Excellent handling properties
	PVC	To 105°C
Strand Range	50 to 16 AWG	Flexibility in meeting application goals
Configurations	Round Square Rectangular	Configurable for maximum operating and space efficiencies

Resistance wire

Kerrigan-Lewis resistance wire achieves high-tolerance resistive values with a copper-nickel alloy. Standard configurations are:

- **55% copper/45% nickel for a resistance of 294 ohms per circular mil-foot**
- **78% copper/22% nickel for a resistance of 180 ohms per circular mil-foot**

Other configurations are also available.

We offer the wire in sizes from 40 AWG to 25 AWG to meet specific resistance and current-carrying needs.

Make AlphaWire.com your destination for all your cabling needs!

Language English

Search GO!

1-800-52-ALPHA

Advanced Search

Products Innovative Solutions Online Tools Engineer's Room Regulations & Compliance News Site Support About AlphaWire

欢迎访问! Explore the new Chinese version of our website!

Custom Made Simple See how fast and easy custom cable is.

Master the Possibilities Check out the new Alpha Wire Master Catalog.

Your Cable, Your Way

Online Cable Design Center makes custom easy. Configure and specify a custom cable quickly and easily. Then get it delivered fast!

LEARN MORE

CUSTOM FOR YOU MADE

New Products at AlphaWire

Series XM

LEARN MORE

A Tougher Cable for Continuous Flex Control Applications

Series XM Flexible Control Cable is the ideal choice for medium-to-high-flex applications. Featuring a premium-grade PVC jacket, Series XM offers a durable, oil-resistant construction that prevents contamination from hazardous fluids and protects against abrasion. Plus, its optimum flexibility and performance allows it to support a variety of industrial applications, including:

- High-speed pick-and-place robotic systems
- Automated material handling equipment
- Conveyors and transfer shuttles
- Flex track installations

Available shielded or unshielded in a variety of gauge sizes, jacket colors, and conductor counts.

Series XM Product Breakdown:

- Meets NFPA Standard 79 for industrial machinery
- Stranded conductors for better flexibility

News

View Archive

4.1.11 Alpha Wire Launches Chinese-language Website

Alpha Wire has launched a Chinese-language version of its website designed to make AlphaWire.com available to an increasingly diversified customer base.

Subscribe to our Newsletter

SUBSCRIBE

Easy to use, full of information, and designed to make the selection of wire, cable, tubing, and wire management fast and easy—the Alpha Wire website is the only source you need.

- Search products by parameters
- View complete product listing
- Download specs
- Read white papers written by our industry experts
- Request a sample (or two!)
- Learn about our market-specific solution sets
- Download literature
- Look around our “Engineer’s Room”
- Build your own cable with our powerful Cable Design Center®

FIT[®] Heat-Shrink Tubing



FIT® Heat-Shrink Tubing



Whether your concerns are mechanical strain relief, environmental sealing, or organizing wires, Alpha Wire's FIT heat-shrink tubing is ideal for solving many challenges in electrical and electronic wiring:

- **Protect substrates from moisture, UV light, corrosion, oxidation, dust, chemicals, abrasion, environmental conditions, solder joints, and encapsulates**
- **Insulate wire terminations and connections, entire printed circuit boards, from electrical and environmental conditions**
- **Repair cable splices, insulation damage and cuts, cable jackets, and connections, with permanent or temporary quick fixes**
- **Relieve strain on cables and connectors to prevent harmful flexing or bending**
- **Bundle and organize wire harness, cable, tubing, and hose dressing on OEM equipment, breakouts, bundle in small spaces, conform to odd shapes**
- **Seal connections, backshells, and other gaps from moisture and other contaminants**
- **Identify circuits through color coding, grouping, and labeling**

FIT heat-shrink products

Our FIT heat-shrink tubing offers a reliable way to protect and seal terminations or add additional mechanical ruggedness. FIT preferred heat-shrink products are made from premium compounds under the tightest manufacturing controls. This means FIT tubing consistently provides excellent physical characteristics such as low longitudinal shrinkage and wide temperature ranges while providing an elegant appearance when used alone or on OEM equipment.

The FIT line consists of various tubing types, each designed with unique attributes that offer tubing solutions for the broadest possible range of applications and environments. FIT products are always in stock and come in an unprecedented variety of package sizes.

Beyond the widely used polyolefin tubing that is suited to the broadest range of general-purpose needs, we offer a number of other materials for higher or lower shrink temperatures, wider operating temperatures, and such special needs as outstanding chemical resistance or increased flexibility.

Material	Features	Shrink Temperature	Shrink Ratio (approx.)	FIT Family
Single-Wall Cross-linked Polyolefin for General-Purpose Use				
Cross-linked polyolefin	General-purpose heat-shrink tubing Range of shrink ratios	90°C	2:1	FIT-221
		90°C	4:1	FIT-421
Flame-retardant cross-linked polyolefin	Low shrink temp Passes UL VW-1 flame test	90°C	2:1	FIT-221V
		90°C	3:1	FIT-321V
Cross-linked polyolefin	Approved for 600-V ground lead identification Green with yellow stripe Passes UL VW-1 flame test	90°C	2:1	FIT-260
Semirigid cross-linked polyolefin	30% stronger and 25% stiffer than standard polyolefin	110°C	2:1	FIT-295
Dual-Wall Polyolefin for Additional Sealing				
Surface cross-linked, dual extruded	Meltable inner wall to encapsulate without adhesive	140°C	2.5:1	FIT-300
		110°C	3:1	FIT-321
		121°C	5.6:1	FIT-621
Bonding, thermoplastic adhesive lined	Bonds to most materials High voltage: to 2 kV at 90°C continuous use	120°C	3:1	FIT-700
Bonding, adhesive lined	Permanent water and corrosion protection	110°C	2:1	FIT-750
Special-Application Tubing				
Irradiated PVC	Low shrink temperature Passes UL VW-1 flame test 30% stronger than standard polyolefin	100°C	2:1	FIT-105
Cross-linked PVDF	High shrink temperature Fast recovery time Excellent chemical, heat, and flame resistance Passes UL VW-1 flame test 3x the tensile strength of standard polyolefin	170°C	2:1	FIT-350
FEP	High shrink temperature Excellent chemical resistance Excellent dielectric properties Thinnest wall thickness available	200°C	1.2:1	FIT-400
PTFE	High shrink temperature Excellent chemical resistance Excellent dielectric properties Very thin wall thickness	250°C	1.5:1	FIT-500
Chlorinated polyolefin	Highly flexible Oil and abrasion resistant Passes UL VW-1 flame test	130°C	2:1	FIT-600
Flexible fluoroelastomer	High shrink temperature Excellent chemical resistance Flexible	120°C	2:1	FIT-650
Polyethylene/polyester	Superior abrasion resistance Excellent flexibility Resists harsh environments	80°C	2:1	FIT-FABRIC
Cross-linked silicone rubber	High flexibility available Pliable Scrape abrasion resistant Passes UL VW-1 flame test	200°C	1.7:1	FIT-FLEX
Cross-linked PVDF	Transparent after shrink Fast recovery time Excellent chemical, heat, and flame resistance Passes UL VW-1 flame test 2x the tensile strength of standard polyolefin	150°C	2:1	FIT-CLEAR

Heat Guns

Alpha heat guns are the perfect complement to our tubing, making it easy to apply FIT heat-shrink tubing quickly and efficiently.

The lightweight, durable guns are designed to make application of heat-shrink tubing fast and reliable. They are well suited to both industrial production and field use.



Heat-Shrink Tubing

FIT®-105 Heat-Shrink Tubing
2:1 Shrink Ratio, Irradiated PVC

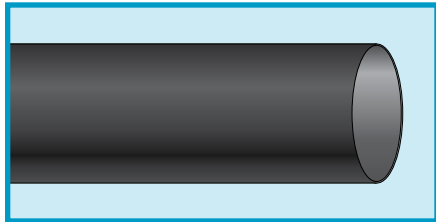

AMS DTL-23053/2 Class 1
(except longitudinal shrinkage)
UL 224 VW-1
CSA 198

- Low shrink temperature
- Fast recovery time
- 30% stronger than standard polyolefin
- Low water absorption
- UV resistant

Operating Temperature

- -20°C to +105°C

Shrink Temperature

- 100°C min.
- 105°C full recovery

Material

- Irradiated PVC

Color

- Black

Physical Properties

- Tensile strength: 3000 psi (20.68 N/mm²)
- Elongation: 300% min
- Longitudinal change: +1%/-25%
- Specific gravity: 1.32
- Flame retardant
- Shelf life: 1 year at 18°C to 35°C

Chemical Properties

- Corrosive effect: none
- Fungus resistance: no growth
- Water absorption: 1.0% max.
- Lead free

Electrical Properties

- 600 V (UL, CSA)
- Dielectric strength: 1083 V/mil (426.3 kV/cm)
- Volume resistivity: 10¹² ohm-cm

Availability

See table

Spools may contain multiple lengths

Part No.	Supplied ID, Min.		Recovered ID, Max.		Recovered Wall Thickness, Nom.		Availability	
	Inch	mm	Inch	mm	Inch	mm	Ft	m
FIT-105-3/64	0.046	1.17	0.023	0.58	0.020	0.51	25, 100, 500, 1000	7.6, 30.5, 152, 305
FIT-105-1/16	0.062	1.57	0.031	0.79	0.020	0.51	25, 100, 500, 1000	7.6, 30.5, 152, 305
FIT-105-3/32	0.093	2.36	0.046	1.17	0.020	0.51	25, 100, 1000	7.6, 30.5, 305
FIT-105-1/8	0.125	3.18	0.062	1.57	0.025	0.64	25, 100, 1000	7.6, 30.5, 305
FIT-105-3/16	0.187	4.75	0.093	2.36	0.025	0.64	25, 100, 1000	7.6, 30.5, 305
FIT-105-1/4	0.250	6.35	0.125	3.18	0.025	0.64	25, 100, 1000	7.6, 30.5, 305
FIT-105-3/8	0.375	9.53	0.187	4.75	0.030	0.76	25, 100, 500	7.6, 30.5, 152
FIT-105-1/2	0.500	12.70	0.250	6.35	0.030	0.76	25, 100, 250	7.6, 30.5, 76.2
FIT-105-3/4	0.750	19.05	0.375	9.53	0.035	0.89	25, 100, 250	7.6, 30.5, 76.2
FIT-105-1IN	1.000	25.40	0.500	12.70	0.040	1.02	25, 100, 250	7.6, 30.5, 76.2
FIT-105-1-1/2	1.500	38.10	0.750	19.05	0.045	1.14	25, 100	7.6, 30.5

Packaged Assortments

Assorted sizes of 6”
(15 cm) lengths

FIT-105-MS-1

Contents	Tubing Size		Quantity
	Inch	mm	
FIT-105-3/64	0.046	1.17	10
FIT-105-1/16	0.062	1.57	10
FIT-105-3/32	0.093	2.36	10
FIT-105-1/8	0.125	3.18	10
FIT-105-3/16	0.187	4.75	10
FIT-105-1/4	0.250	6.35	10

FIT-105-MS-2

Contents	Tubing Size		Quantity
	Inch	mm	
FIT-105-3/8	0.375	9.53	10
FIT-105-1/2	0.500	12.70	10
FIT-105-3/4	0.750	19.05	10
FIT-105-1 IN	1.000	25.40	10



Heat-Shrink Tubing

FIT®-221 Heat-Shrink Tubing

2:1 Shrink Ratio, XLPO

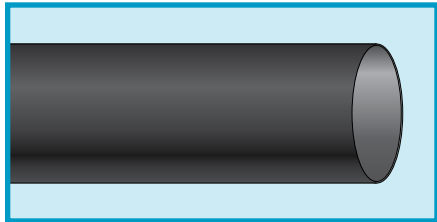

**AMS-DTL-23053/5 Class 1
(except clear)**

**AMS-DTL-23053/5 Class 2
(clear)**

UL 224 (except clear)

CSA 198 (except clear)

- Excellent general-purpose tubing
- Low water absorption
- UV resistant (black only)

Operating Temperature

- -55°C to +135°C
- -55°C to +125°C (UL, CSA)

Shrink Temperature

- 90°C min.
- 121°C full recovery

Material

- Cross-linked polyolefin

Color

- Black, white, red, yellow, blue, green, clear*

*Clear tubing may exhibit some color tint that is the result of the product's chemistry; the tint is variable and can be any color

Physical Properties

- Tensile strength: 1500 psi (10.34 N/mm²)
- Elongation: 200% min
- Longitudinal change: ±5%

- Specific gravity: 1.35 (colors)/1.00 (clear)
- Flame retardant
- Shelf life: 5 years at 18°C to 35°C

Chemical Properties

- Corrosive effect: none
- Fungus resistance: no growth
- Water absorption: 0.5% max.
- Fluid resistance: 1000 psi (6.89 N/mm²)
- Lead free

Electrical Properties

- 600 V (UL, CSA)
- Dielectric strength: 500 V/mil (197 kV/cm)
- Volume resistivity: 10¹⁴ ohm-cm

Availability

See table, next page

Spools may contain multiple lengths

Part No.	Supplied ID, Min.		Recovered ID, Max.		Recovered Wall Thickness, Nom.	
	Inch	mm	Inch	mm	Inch	mm
FIT-221-3/64	0.046	1.17	0.023	0.58	0.016	0.41
FIT-221-1/16	0.063	1.60	0.031	0.79	0.017	0.43
FIT-221-3/32	0.093	2.36	0.046	1.17	0.020	0.51
FIT-221-1/8	0.125	3.18	0.062	1.57	0.020	0.51
FIT-221-3/16	0.187	4.75	0.093	2.36	0.020	0.51
FIT-221-1/4	0.250	6.35	0.125	3.18	0.025	0.64
FIT-221-3/8	0.375	9.53	0.187	4.75	0.025	0.64
FIT-221-1/2	0.500	12.70	0.250	6.35	0.025	0.64
FIT-221-3/4	0.750	19.05	0.375	9.53	0.030	0.76
FIT-221-1IN	1.000	25.40	0.500	12.70	0.035	0.89
FIT-221-1-1/2	1.500	38.10	0.750	19.05	0.040	1.02
FIT-221-2IN	2.000	50.80	1.000	25.40	0.045	1.14
FIT-221-3IN	3.000	76.20	1.500	38.10	0.050	1.27
FIT-221-4IN	4.000	101.60	2.000	50.80	0.055	1.40



Heat-Shrink Tubing

FIT®-221 Heat-Shrink Tubing

2:1 Shrink Ratio, XLPO

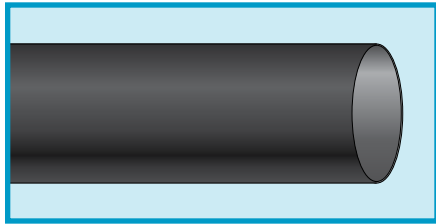

AMS-DTL-23053/5 Class 1
(except clear)

AMS-DTL-23053/5 Class 2
(clear)

UL 224 (except clear)

CSA 198 (except clear)

Availability

Part No.	Spools		Qty, Cut Pieces at Length			
	Ft	m	4 ft (1.2 m)	6" (152 mm)	1" (25.4 mm)	0.5" (12.7 mm)
FIT-221-3/64	1000*	305*	25	40	1000	1000
FIT-221-1/16	70, 100*, 1000	21.3, 30.5*, 305	25	36	1000	1000
FIT-221-3/32	65, 100*, 500	19.8, 30.5*, 152	25	32	1000	1000
FIT-221-1/8	60, 100*, 500	18.2, 30.5*, 152	25	28	1000	1000
FIT-221-3/16	50, 100*, 500	15.2, 30.5*, 152	25	24	1000	1000
FIT-221-1/4	40, 100*, 250	12.2, 30.5, 76.2*	25	20	1000	1000
FIT-221-3/8	35, 50*, 200	10.6, 15.2*, 60.9	25	16	1000	1000
FIT-221-1/2	32, 50*, 150	9.7, 15.2*, 45.7	5	14	—	—
FIT-221-3/4	24, 50*, 250	7.3, 15.2*, 76.2	5	12	—	—
FIT-221-1IN	16, 50*, 250	4.8, 15.2, 76.2	5	8	—	—
FIT-221-1-1/2	125*	38.1*	5	5	—	—
FIT-221-2IN	125*	38.1*	5	3	—	—
FIT-221-3IN	100*	30.5*	2	2	—	—
FIT-221-4IN	50*	15.2*	2	—	—	—

*Black and clear tubing only.

Spools may contain multiple lengths.

Packaged Assortments

Assorted sizes of 6"
(152 mm) lengths

Each length is size identified.

FIT-221-MS-1 Assorted colors: Black, blue, red, green, yellow

Contents	Tubing Size		Quantity
	Inch	mm	
FIT-221-3/64	0.046	1.17	6
FIT-221-1/16	0.063	1.60	6
FIT-221-3/32	0.093	2.36	6
FIT-221-1/8	0.125	3.18	6
FIT-221-3/16	0.187	4.75	6

FIT-221-MS-2 Assorted colors: Black, blue, red, yellow

Contents	Tubing Size		Quantity
	Inch	mm	
FIT-221-1/4	0.250	6.35	4
FIT-221-3/8	0.375	9.53	4
FIT-221-1/2	0.500	12.70	4
FIT-221-3/4	0.750	19.05	4

FIT-221 Kits

FIT-KIT-221BK

Colors: Black

Contents	Tubing Size		Quantity
	Inch	mm	
FIT-221-3/16	0.187	4.75	25
FIT-221-1/4	0.250	6.35	20
FIT-221-3/8	0.375	9.53	15
FIT-221-1/2	0.500	12.70	10
FIT-221-3/4	0.750	19.05	6
FIT-221-1IN	1.000	25.40	4

FIT-KIT-221C Assorted colors: Black, blue, red, white, green, yellow, clear

Contents	Tubing Size		Quantity	
	Inch	mm	Each Color	Total
FIT-221-3/32	0.093	2.36	4	28
FIT-221-1/8	0.125	3.18	3	21
FIT-221-3/16	0.187	4.75	3	21
FIT-221-1/4	0.250	6.35	3	21
FIT-221-3/8	0.375	9.53	2	14
FIT-221-1/2	0.500	12.70	2	14



Heat-Shrink Tubing

FIT®-221B Heat-Shrink Tubing
2:1 Shrink Ratio, XLPO, Bulk Packaging

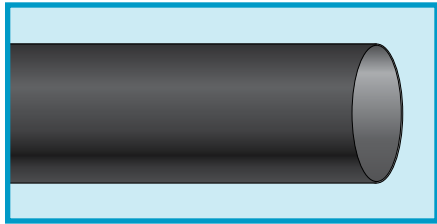

AMS-DTL-23053/5 Class 1 (except clear)
AMS-DTL-23053/5 Class 2 (clear)
UL 224 (except clear)
CSA 198 (except clear)

- Excellent general-purpose tubing
- Low shrink temperature
- Fastest recovery time
- Low water absorption
- UV resistant (black only)

Operating Temperature

- -55°C to +135°C
- -55°C to +125°C (UL, CSA)

Shrink Temperature

- 90°C min.
- 121°C full recovery

Material

- Cross-linked polyolefin

Colors

- Black, blue, clear*

*Clear tubing may exhibit some color tint that is the result of the product's chemistry; the tint is variable and can be any color

Physical Properties

- Tensile strength: 1500 psi (10.34 N/mm²)
- Elongation: 200% min
- Longitudinal change: ±5%

- Specific gravity: 1.35 (colors)/1.00 (clear)
- Flame retardant
- Shelf life: 5 years at 18°C to 35°C

Chemical Properties

- Corrosive effect: none
- Fungus resistance: no growth
- Water absorption: 0.5% max.
- Fluid resistance: 1000 psi (6.89 N/mm²)
- Lead free

Electrical Properties

- 600 V (UL, CSA)
- Dielectric strength: 500 V/mil (197 kV/cm)
- Volume resistivity: 10¹⁴ ohm-cm

Availability

See table

Spools may contain multiple lengths

Part No.	Supplied ID, Min.		Recovered ID, Max.		Recovered Wall Thickness, Nom.	
	Inch	mm	Inch	mm	Inch	mm
FIT-221B-3/64	0.046	1.17	0.023	0.58	0.016	0.41
FIT-221B-1/16	0.063	1.60	0.031	0.79	0.017	0.43
FIT-221B-3/32	0.093	2.36	0.046	1.17	0.020	0.51
FIT-221B-1/8	0.125	3.18	0.062	1.57	0.020	0.51
FIT-221B-3/16	0.187	4.75	0.093	2.36	0.020	0.51
FIT-221B-1/4	0.250	6.35	0.125	3.18	0.025	0.64
FIT-221B-3/8	0.375	9.53	0.187	4.75	0.025	0.64
FIT-221B-1/2	0.500	12.70	0.250	6.35	0.025	0.64
FIT-221B-3/4	0.750	19.05	0.375	9.53	0.030	0.76
FIT-221B-1IN	1.000	25.40	0.500	12.70	0.035	0.89

Availability

Part No.	Spools (Length x No. of Spools)		Qty, Cut Pieces at Length 4 ft (1.2 m)
	Ft	m	
FIT-221B-3/64	1000 x 3	305 x 3	250
FIT-221B-1/16	1000 x 3	305 x 3	250
FIT-221B-3/32	500 x 3	152 x 3	250
FIT-221B-1/8	500 x 3	152 x 3	250
FIT-221B-3/16	500 x 2	152 x 2	250
FIT-221B-1/4	250 x 2	76.2 x 2	250
FIT-221B-3/8	200 x 2	60.9 x 2	250
FIT-221B-1/2	150 x 2	45.7 x 2	200
FIT-221B-3/4	250 x 1 250 x 2	76.2 x 1 76.2 x 2	125
FIT-221B-1IN	250 x 1	76.2 x 1	75



Heat-Shrink Tubing

FIT®-221V Heat-Shrink Tubing

2:1 Shrink Ratio, XLPO, Low Shrink Temperature

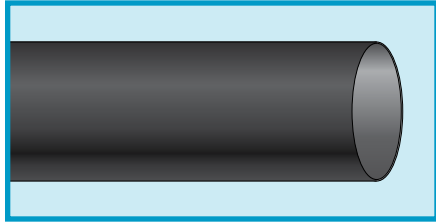

AMS DTL-23053/5 Class 1 and 3
UL 224 VW-1
CSA 198

- Excellent general-purpose tubing
- Low shrink temperature
- Fastest recovery time
- Low water absorption
- UV resistant (black only)

Operating Temperature

- -55°C to +135°C
- -55°C to +125°C (UL, CSA)

Shrink Temperature

- 90°C min.
- 121°C full recovery

Material

- Cross-linked polyolefin

Colors

- Black, white, red, yellow, green, blue

Physical Properties

- Tensile strength: 1500 psi (10.34 N/mm²)
- Elongation: 200% min
- Longitudinal change: ±5%
- Specific gravity: 1.35
- Flame retardant
- Shelf life: 5 years at 18°C to 35°C

Chemical Properties

- Corrosive effect: none
- Fungus resistance: no growth
- Water absorption: 0.5% max.
- Fluid resistance: 1000 psi (6.89 N/mm²)
- Lead free

Electrical Properties

- 600 V (UL, CSA)
- Dielectric strength: 500 V/mil (197 kV/cm)
- Volume resistivity: 10¹⁴ ohm-cm

Availability

See table

Spools may contain multiple lengths

Part No.	Supplied ID, Min.		Recovered ID, Max.		Recovered Wall Thickness, Nom.	
	Inch	mm	Inch	mm	Inch	mm
FIT-221V-3/64	0.046	1.17	0.023	0.58	0.016	0.41
FIT-221V-1/16	0.063	1.60	0.031	0.79	0.017	0.43
FIT-221V-3/32	0.093	2.36	0.046	1.17	0.020	0.51
FIT-221V-1/8	0.125	3.18	0.062	1.57	0.020	0.51
FIT-221V-3/16	0.187	4.75	0.093	2.36	0.020	0.51
FIT-221V-1/4	0.250	6.35	0.125	3.18	0.025	0.64
FIT-221V-3/8	0.375	9.53	0.187	4.75	0.025	0.64
FIT-221V-1/2	0.500	12.70	0.250	6.35	0.025	0.64
FIT-221V-3/4	0.750	19.05	0.375	9.53	0.030	0.76
FIT-221V-1IN	1.000	25.40	0.500	12.70	0.035	0.89
FIT-221V-1-1/2	1.500	38.10	0.750	19.05	0.040	1.02
FIT-221V-2IN	2.000	50.80	1.000	25.40	0.045	1.14

Availability

Part No.	Spools (Length x No. of Spools)		Qty, Cut Pieces at Length	
	Ft	m	4 ft (1.2 m)	6" (152 mm)
FIT-221V-3/64	1000 x 3	305 x3	25, 250	40
FIT-221V-1/16	1000 x 1, 1000 x 3	305 x 1, 305 x 3	25, 250	36
FIT-221V-3/32	500 x 1, 500 x 3	152 x 1, 152 x 3	25, 250	32
FIT-221V-1/8	500 x 1, 500 x 3	152 x 1, 152 x 3	25, 250	28
FIT-221V-3/16	500 x 1, 500 x 2	152 x 1, 152 x 2	25, 250	24
FIT-221V-1/4	250 x 1, 250 x 2	76.2 x 1, 76.2 x 2	25, 250	20
FIT-221V-3/8	200 x 1, 200 x 2	60.9 x 1, 60.9 x 2	25, 250	16
FIT-221V-1/2	150 x 1, 150 x 2	45.7 x 1, 45.7 x 2	5, 200	14
FIT-221V-3/4	250 x 1	76.2 x 1	5, 125	12
FIT-221V-1IN	250 x 1	76.2 x 1	5, 75	8
FIT-221V-1-1/2	125 x 1	38.1 x 1	5	5
FIT-221V-2IN	125 x 1	38.1 x 1	5	3



Heat-Shrink Tubing

FIT®-260 Heat-Shrink Tubing

2:1 Shrink Ratio, XLPO, Ground Lead Identification

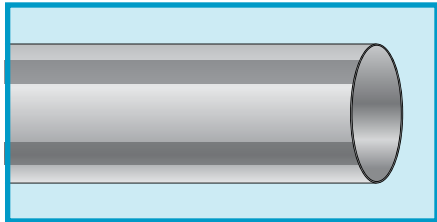

UL 224 VW-1 CSA 198

- Excellent general-purpose tubing
- Low water absorption

Operating Temperature

- -55°C to +135°C
- -55°C to +125°C (UL, CSA)

Shrink Temperature

- 90°C min.
- 120°C full recovery

Material

- Cross-linked polyolefin

Color

- Green/yellow

Physical Properties

- Tensile strength: 1500 psi (10.34 N/mm²)
- Elongation: 200% min
- Longitudinal change: ±5%
- Specific gravity: 1.35
- Flame retardant
- Shelf life: 25 years at 18°C to 35°C

Chemical Properties

- Corrosive effect: none
- Fungus resistance: no growth
- Water absorption: 0.5% max.
- Fluid resistance: 1000 psi (6.89 N/mm²)
- Lead free

Electrical Properties

- 600 V (UL, CSA)
- Dielectric strength: 500 V/mil (197 kV/cm)
- Volume resistivity: 10¹⁴ ohm-cm

Availability

See table

Spools may contain multiple lengths

Part No.	Supplied ID, Min.		Recovered ID, Max.		Recovered Wall Thickness, Nom.		Availability	
	Inch	mm	Inch	mm	Inch	mm	Ft	m
FIT-260-1/8	0.125	3.18	0.062	1.57	0.020	0.51	500	152
FIT-260-1/4	0.250	6.35	0.125	3.18	0.025	0.64	250	76.2
FIT-260-3/8	0.375	9.53	0.187	4.75	0.025	0.64	250	76.2
FIT-260-1/2	0.500	12.70	0.250	6.35	0.025	0.64	250	76.2
FIT-260-3/4	0.750	19.05	0.375	9.53	0.030	0.76	250	76.2
FIT-260-1	1.000	25.40	0.500	12.70	0.035	0.89	100	30.5



Heat-Shrink Tubing

FIT®-295 Heat-Shrink Tubing
2:1 Shrink Ratio, Semirigid XLPO

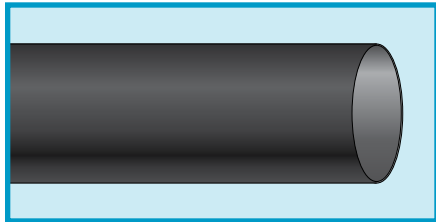

AMS-DTL-23053/6 Class 1 (Black)

AMS-DTL-23053/6 Class 2 (Clear)

UL 224 VW-1 (Black)

CSA 198 (Black)

- 30% stronger than standard XLPO
- 25% stiffer than standard XLPO
- Low water absorption
- UV resistant (black only)

Operating Temperature

- -55°C to +135°C
- -55°C to +125°C (UL, CSA)

Shrink Temperature

- 110°C min.
- 135°C full recovery

Material

- Semirigid cross-linked polyolefin

Colors

- Black, clear

Physical Properties

- Tensile strength: 2000 psi (17.79 N/mm²)
- Elongation: 200% min
- Longitudinal change: ±5%
- Specific gravity: 1.35 (black)/1.00 (clear)
- Flame retardant
- Shelf life: 5 years at 18°C to 35°C

Chemical Properties

- Corrosive effect: none
- Fungus resistance: no growth
- Water absorption: 0.5% max. (black)/0.02% max. (clear)
- Lead free

Electrical Properties

- 600 V (UL, CSA)
- Dielectric strength: 500 V/mil (197 kV/cm)
- Volume resistivity: 10¹⁴ ohm-cm

Availability

See table

Part No.	Supplied ID, Min.		Recovered ID, Max.		Recovered Wall Thickness, Nom.		Availability Qty, Cut Pieces at Length	
	Inch	mm	Inch	mm	Inch	mm	4 ft (1.2 m)	6" (152 mm)
FIT-295-3/64	0.046	1.17	0.023	0.58	0.020	0.51	25	40
FIT-295-1/16	0.063	1.60	0.031	0.79	0.020	0.51	25	36
FIT-295-3/32	0.093	2.36	0.046	1.17	0.020	0.51	25	32
FIT-295-1/8	0.125	3.18	0.062	1.57	0.020	0.51	25	28
FIT-295-3/16	0.187	4.75	0.093	2.36	0.025	0.64	25	24
FIT-295-1/4	0.250	6.35	0.125	3.18	0.025	0.64	25	20
FIT-295-3/8	0.375	9.53	0.187	4.75	0.030	0.76	25	16
FIT-295-1/2	0.500	12.70	0.250	6.35	0.030	0.76	5	14



Heat-Shrink Tubing

FIT®-300 Heat-Shrink Tubing

2.5:1 Shrink Ratio, Dual-Wall Semirigid XLPO

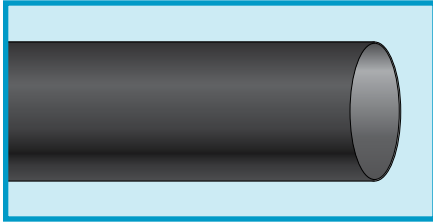

AMS-DTL-23053/4 Class 1 UL 224 (Except clear)

- Meltable inner wall for encapsulation without adhesives
- Thicker wall for added protection
- High shrink ratios
- Excellent dielectric properties

Applications

- Temporary sealing without sticky residue
- Substrates requiring filled interstices

Operating Temperature

- -55°C to +135°C
- -55°C to +125°C (UL)

Shrink Temperature

- 140°C min.

Material

- Dual-wall semirigid cross-linked polyolefin

Colors

- Black, white, red, yellow, blue, slate, brown

Physical Properties

- Tensile strength: 1500 psi (10.34 N/mm²)
- Elongation: 200% min

- Longitudinal change: +1%/-10%
- Specific gravity: 0.99
- Shelf life: 3 years at 18°C to 35°C

Chemical Properties

- Corrosive effect: none
- Fungus resistance: no growth
- Water absorption: 0.5% max
- Fluid resistance: 1000 psi (6.89 N/mm²)
- Lead free
- Halogen free

Electrical Properties

- 600 V (UL, CSA)
- Dielectric strength: 500 V/mil (197 kV/cm)
- Volume resistivity: 10¹⁶ ohm-cm

Availability

See table

Part No.	Supplied ID, Min.		Recovered ID, Max.		Recovered Wall Thickness, Nom.		Availability Qty, Cut Pieces at Length	
	Inch	mm	Inch	mm	Inch	mm	4 ft (1.2 m)	6" (152 mm)
FIT-300-1/8	0.125	3.18	0.023	0.58	0.038	0.97	25	14
FIT-300-3/16	0.187	4.75	0.060	1.52	0.043	1.09	25	12
FIT-300-1/4	0.250	6.35	0.080	2.03	0.047	1.19	25	10
FIT-300-3/10	0.300	7.62	0.050	1.27	0.100	2.54	25	4
FIT-300-3/8	0.375	9.53	0.135	3.43	0.050	1.27	25	8
FIT-300-1/2	0.500	12.70	0.195	4.95	0.055	1.40	5	6
FIT-300-3/4	0.750	19.05	0.313	7.95	0.065	1.65	5	4
ST-3001-IN	1.000	25.40	0.400	10.16	0.075	1.91	5	--



Heat-Shrink Tubing

FIT®-321 Heat-Shrink Tubing

3:1 Shrink Ratio, Dual-Wall XLPO, Adhesive Lined

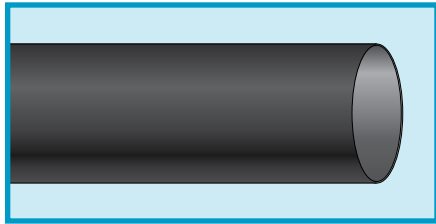

**AMS-DTL-23053/4 Class 3
UL 224
CSA 198**

- Thicker wall for increased durability
- Water-resistant inner permanent-bonding adhesive

Operating Temperature

- -55°C to +125°C

Shrink Temperature

- 110°C min.
- 110°C full recovery

Material

- Dual-wall flexible polyolefin with thick-wall adhesive

Color

- Black

Physical Properties

- Tensile strength: 1500 psi (10.34 N/mm²)
- Elongation: 250% min
- Longitudinal change: +1%/-15%
- Flame tested
- Shelf life: 3 years at 18°C to 35°C

Chemical Properties

- Corrosive effect: none
- Fungus resistance: no growth
- Water absorption: 1.0% max
- Fluid resistance: 900 psi (6.20 N/mm²)
- UV resistant
- Lead free

Electrical Properties

- 600 V (UL, CSA)
- Dielectric strength: 300 V/mil (118 kV/cm)
- Volume resistivity: 10¹² ohm-cm

Availability

See table

Part No.	Supplied ID, Min.		Recovered ID, Max.		Recovered Wall Thickness, Nom.		Recovered Melt Wall Thickness, Nom.	
	Inch	mm	Inch	mm	Inch	mm	Inch	mm
FIT-321-1/8	0.125	3.18	0.024	0.61	0.037	0.94	0.020	0.51
FIT-321-1/4	0.252	6.40	0.073	1.85	0.047	1.19	0.020	0.51
ST-303-3/8	0.374	9.50	0.118	3.00	0.051	1.30	0.025	0.64
FIT-321-1/2	0.500	12.70	0.157	3.99	0.071	1.80	0.030	0.76
ST-303-3/4	0.748	19.00	0.236	5.99	0.071	1.80	0.035	0.89
FIT-321-1	0.945	24.00	0.315	8.00	0.098	2.49	0.040	1.02
FIT-321-1-1/2	1.575	40.01	0.512	13.00	0.098	2.49	0.040	1.02

Availability

Part No.	Qty, Cut Pieces at Length	
	4 ft (1.2 m)	6" (152 mm)
FIT-321-1/8	25	28
FIT-321-1/4	25	20
FIT-321-1/2	5	14
FIT-321-1	5	8
FIT-321-1-1/2	5	5

Packaged Assortments

Assorted sizes of 6" (15 cm) lengths

FIT-321-MS-1 Colors: Black

	Size		Quantity
	Inch	mm	
FIT-321-1/8	0.125	3.18	5
FIT-321-1/4	0.252	6.40	5
FIT-321-1/2	0.500	12.70	5
FIT-321-1	0.945	24.00	5



Heat-Shrink Tubing

FIT®-321V Heat-Shrink Tubing

3:1 Shrink Ratio, Flexible XLPO, Thin Wall

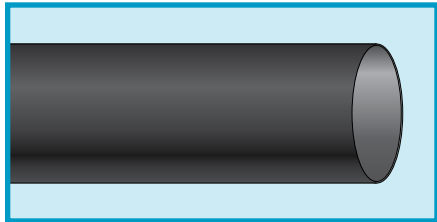

AMS-DTL-23053/5 Class 1 and 3 (except dimensions)
UL 224 VW-1
CSA 198

- Low shrink temperature
- Fast recovery time
- Reduced wall thickness

Operating Temperature

- -55°C to +135°C
- -55°C to +125°C (UL, CSA)

Shrink Temperature

- 90°C min.
- 135°C full recovery

Material

- Flexible cross-linked thin-wall polyolefin

Colors

- Black, white

Physical Properties

- Tensile strength: 1500 psi (10.34 N/mm²)
- Elongation: 200% min
- Longitudinal change: +5%/-15%
- Specific gravity: 1.35

- Flame retardant
- Shelf life: 25 years at 18°C to 35°C

Chemical Properties

- Corrosive effect: none
- Fungus resistance: no growth
- Water absorption: 0.5% max
- Fluid resistance: 1000 psi (6.89 N/mm²)

Electrical Properties

- 600 V (UL, CSA)
- Dielectric strength: 500 V/mil (197 kV/cm)
- Volume resistivity: 10¹⁴ ohm-cm

Availability

See table

Spools may contain multiple lengths

Part No.	Supplied ID, Min.		Recovered ID, Max.		Recovered Wall Thickness, Nom.		Availability	
	Inch	mm	Inch	mm	Inch	mm	Ft	m
FIT-321V-3/32	0.060	1.52	0.020	0.51	0.020	0.51	500	152
FIT-321V-1/8	0.120	3.05	0.040	1.02	0.024	0.61	500	152
FIT-321V-1/4	0.240	6.10	0.080	2.03	0.028	0.71	250	76.2
FIT-321V-3/8	0.360	9.14	0.120	3.05	0.031	0.79	200	60.9
FIT-321V-1/2	0.472	11.99	0.160	4.06	0.033	0.84	150	45.7
FIT-321V-3/4	0.720	18.29	0.240	6.10	0.039	0.99	250	76.2
FIT-321V-1IN	0.945	24.00	0.315	8.00	0.048	1.22	250	76.2



Heat-Shrink Tubing

FIT®-350 Heat-Shrink Tubing
2:1 Shrink Ratio, PVDF

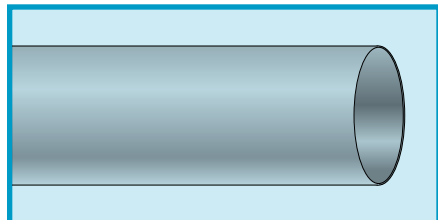

AMS-DTL-23053/8
UL 224 VW-1

- Chemical resistant
- Heat resistant
- 3x the tensile strength of standard XLPO

Operating Temperature

- -55°C to +135°C
- -55°C to +150°C (UL)

Shrink Temperature

- 170°C min.
- 175°C full recovery

Material

- Cross-linked polyvinylidene fluoride

Color

- Clear

Physical Properties

- Tensile strength: 5000 psi (34.47 N/mm²)
- Elongation: 150% min
- Longitudinal change: ±10%
- Specific gravity: 1.80

- Flame retardant
- Shelf life: 5 years at 18°C to 35°C

Chemical Properties

- Corrosive effect: none
- Fungus resistance: no growth
- Water absorption: 0.5% max
- Fluid resistance: 5000 psi (34.47 N/mm²)
- Lead free

Electrical Properties

- 600 V (UL)
- Dielectric strength: 800 V/mil (315 kV/cm)
- Volume resistivity: 10¹³ ohm-cm

Availability

See table

Part No.	Supplied ID, Min.		Recovered ID, Max.		Recovered Wall Thickness, Nom.		Availability	
	Inch	mm	Inch	mm	Inch	mm	4 ft (1.2 m)	6" (152 mm)
FIT-350-3/64	0.046	1.17	0.023	0.58	0.010	0.25	25	32
FIT-350-1/16	0.063	1.60	0.031	0.79	0.010	0.25	25	28
FIT-350-3/32	0.093	2.36	0.046	1.17	0.010	0.25	25	24
FIT-350-1/8	0.125	3.18	0.062	1.57	0.010	0.25	25	20
FIT-350-3/16	0.187	4.75	0.093	2.36	0.010	0.25	25	16
FIT-350-1/4	0.250	6.35	0.125	3.18	0.012	0.30	25	12
FIT-350-3/8	0.375	9.53	0.187	4.75	0.012	0.30	25	8
FIT-350-1/2	0.500	12.70	0.250	6.35	0.012	0.30	5	4
FIT-350-3/4	0.750	19.05	0.375	9.53	0.017	0.43	5	2
FIT-350-1IN	1.000	25.40	0.500	12.70	0.019	0.48	5	1



Heat-Shrink Tubing

FIT®-400 Heat-Shrink Tubing

1.2:1 Shrink Ratio, FEP

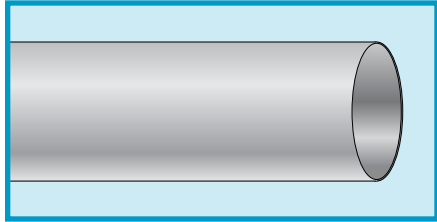

AMS-DTL-23053/11 Class 1

- Chemical resistant
- Wide temperature range
- Excellent dielectric properties
- Thinnest wall thickness available
- Lower recovery temperature than PTFE

Operating Temperature

- -75°C to +200°C

Shrink Temperature

- 175°C full recovery

Material

- FEP

Color

- Natural

Physical Properties

- Tensile strength: 2000 psi (13.79 N/mm²)
- Elongation: 200% min
- Longitudinal change: ±15%
- Specific gravity: 2.17

- Flame rating: UL 94V-0
- Shelf life: 4 years at 18°C to 35°C

Chemical Properties

- Corrosive effect: none
- Fluid resistance: pass
- Fungus resistance: no growth
- Water absorption: 0.01% max
- Lead free

Electrical Properties

- Dielectric strength: 2000 V/mil (787 kV/cm)
- Volume resistivity: 10¹⁷ ohm-cm

Availability

See table

Part No.	Supplied ID, Min.		Recovered ID, Max.		Recovered Wall Thickness, Nom.		Availability Qty, Cut Pieces at Length	
	Inch	Mm	Inch	mm	Inch	mm	4 ft (1.2 m)	2 ft (0.6 m)
FIT-400-24	0.031	0.79	0.027	0.69	0.008	0.20	25	—
FIT-400-22	0.036	0.91	0.032	0.81	0.008	0.20	25	—
FIT-400-20	0.045	1.14	0.039	0.99	0.008	0.20	25	—
FIT-400-18	0.060	1.52	0.049	1.24	0.008	0.20	25	—
FIT-400-16	0.075	1.91	0.061	1.55	0.009	0.23	25	—
FIT-400-14	0.092	2.34	0.072	1.83	0.009	0.23	25	—
FIT-400-12	0.115	2.92	0.089	2.26	0.009	0.23	25	—
FIT-400-10	0.141	3.58	0.114	2.90	0.010	0.25	25	—
FIT-400-9	0.158	4.01	0.124	3.15	0.010	0.25	25	—
FIT-400-8	0.180	4.57	0.143	3.63	0.010	0.25	25	—
FIT-400-7	0.197	5.00	0.158	4.01	0.011	0.28	25	—
FIT-400-6	0.225	5.72	0.180	4.57	0.011	0.28	25	—
FIT-400-5	0.248	6.30	0.198	5.03	0.011	0.28	—	50
FIT-400-4	0.290	7.37	0.226	5.74	0.011	0.28	—	50
FIT-400-3	0.310	7.87	0.249	6.32	0.011	0.28	—	50
FIT-400-2	0.365	9.27	0.280	7.11	0.012	0.30	—	50
FIT-400-1	0.400	10.16	0.311	7.90	0.012	0.30	—	50
FIT-400-0	0.440	11.18	0.349	8.86	0.012	0.30	—	50



Heat-Shrink Tubing

FIT®-421 Heat-Shrink Tubing
4:1 Shrink Ratio, XLPO

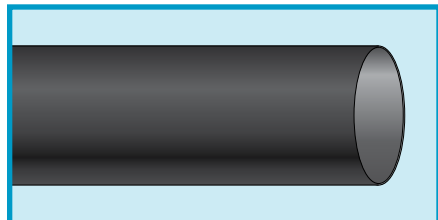

AMS-DTL-23053/5 Class 1 UL 224 VW-1

- High-shrink ratio
- Large supplied diameters
- Conforms to irregular shapes
- Low water absorption
- UV resistant

Operating Temperature

- -55°C to +135°C
- -55°C to +125°C (UL)

Shrink Temperature

- 90°C min.
- 121°C full recovery

Material

- Cross-linked polyolefin

Color

- Black

Physical Properties

- Tensile strength: 1500 psi (10.34 N/mm²)
- Elongation: 200% min
- Longitudinal change: +5%/-15%
- Specific gravity: 1.35

- Flame retardant
- Shelf life: 5 years at 18°C to 35°C

Chemical Properties

- Corrosive effect: none
- Fungus resistance: no growth
- Water absorption: 0.5% max
- Fluid resistance: 1000 psi (6.89 N/mm²)
- UV resistant
- Lead free

Electrical Properties

- 600 V (UL)
- Dielectric strength: 500 V/mil (197 kV/cm)
- Volume resistivity: 10¹⁴ ohm-cm

Availability

See table

Part No.	Supplied ID, Min.		Recovered ID, Max.		Recovered Wall Thickness, Nom.		Availability Qty, Cut Pieces at Length	
	Inch	mm	Inch	mm	Inch	mm	4 ft (1.2 m)	15 ft (4.5 m)
FIT-421-1IN	1.000	25.40	0.260	6.60	0.045	1.14	5	—
FIT-421-1-1/2	1.500	38.10	0.375	9.53	0.045	1.14	5	—
FIT-421-2IN	2.000	50.80	0.550	13.97	0.045	1.14	5	—
FIT-421-3IN	3.000	76.20	0.810	20.57	0.045	1.14	2	—
FIT-421-4IN	4.000	101.60	1.050	26.67	0.045	1.14	2	—



Heat-Shrink Tubing

FIT®-500 Heat Shrink Tubing

1.5:1 Shrink Ratio, PTFE

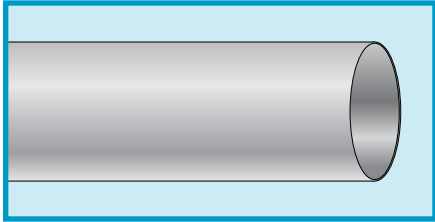

AMS-DTL-23053/12 Class 3

- Excellent chemical resistance
- Widest temperature range
- High tensile strength
- Excellent dielectric properties
- Extremely thin wall thickness
- Low friction coefficient

Operating Temperature

- -75°C to +260°C

Shrink Temperature

- 327°C full recovery

Material

- PTFE

Color

- Natural

Physical Properties

- Tensile strength: 2500 psi (17.21 N/mm²)
- Elongation: 200% min
- Longitudinal change: ±20%
- Specific gravity: 2.20
- Flame rating: UL 94V-0
- Shelf life: 4 years at 18°C to 35°C

Chemical Properties

- Corrosive effect: none
- Fungus resistance: no growth
- Water absorption: 0.01% max
- Fluid resistance: pass
- Lead free

Electrical Properties

- Dielectric strength: 800 V/mil (315 kV/cm)
- Volume resistivity: 10¹⁸ ohm-cm

Availability

See table

Part No.	Supplied ID, Min.		Recovered ID, Max.		Recovered Wall Thickness, Nom.		Availability, Cut Pieces at Length 2 ft (0.6 m)
	Inch	mm	Inch	mm	Inch	mm	
FIT-500-30	0.034	0.86	0.015	0.38	0.009	0.23	50
FIT-500-28	0.038	0.97	0.018	0.46	0.009	0.23	50
FIT-500-26	0.046	1.17	0.022	0.56	0.010	0.25	50
FIT-500-24	0.050	1.27	0.027	0.69	0.010	0.25	50
FIT-500-22	0.055	1.40	0.032	0.81	0.012	0.30	50
FIT-500-20	0.060	1.52	0.039	0.99	0.012	0.30	50
FIT-500-18	0.076	1.93	0.049	1.24	0.012	0.30	50
FIT-500-16	0.093	2.36	0.061	1.55	0.012	0.30	50
FIT-500-14	0.120	3.05	0.072	1.83	0.012	0.30	50
FIT-500-12	0.150	3.81	0.089	2.26	0.012	0.30	25
FIT-500-10	0.191	4.85	0.112	2.84	0.012	0.30	25
FIT-500-8	0.240	6.10	0.141	3.58	0.015	0.38	25
FIT-500-6	0.302	7.67	0.178	4.52	0.015	0.38	10
FIT-500-4	0.370	9.40	0.224	5.69	0.015	0.38	10
FIT-500-2	0.430	10.92	0.278	7.06	0.015	0.38	10
FIT-500-0	0.470	11.94	0.347	8.81	0.015	0.38	10



Heat-Shrink Tubing

FIT®-600 Heat Shrink Tubing
2:1 Shrink Ratio, Chlorinated PO

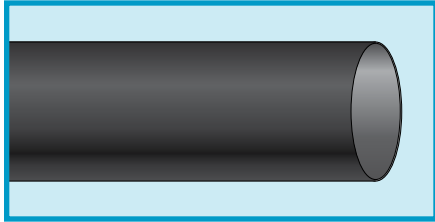

AMS-DTL-23053/1 Class 1 and 2

- More flexible than standard XLPO
- 2x the tensile strength of silicone rubber
- Large tubing diameters
- Oil resistant
- Abrasion resistant

Operating Temperature

- -75°C to +121°C

Shrink Temperature

- 130°C min.
- 130°C full recovery

Material

- Chlorinated polyolefin

Color

- Black

Physical Properties

- Tensile strength: 1500 psi (10.34 N/mm²)
- Elongation: 250% min
- Longitudinal change: +1%/-10%
- Specific gravity: 1.30
- Flame retardant
- Shelf life: 1 year at 18°C to 35°C

Chemical Properties

- Corrosive effect: none
- Fungus resistance: no growth
- Water absorption: 1.0% max
- Fluid resistance: 1000 psi (6.89 N/mm²)
- UV resistant
- Lead free

Electrical Properties

- Dielectric strength: 300 V/mil (118 kV/cm)
- Volume resistivity: 10¹¹ ohm-cm

Availability

See table

Spools may contain multiple lengths

Part No.	Supplied ID, Min.		Recovered ID, Max.		Recovered Wall Thickness, Nom.		Availability	
	Inch	mm	Inch	mm	Inch	mm	Ft	m
FIT-600-1/4	0.250	6.35	0.143	3.63	0.035	0.89	25, 150	7.6, 46
FIT-600-3/8	0.375	9.53	0.211	5.36	0.040	1.02	25, 150	7.6, 46
FIT-600-1/2	0.500	12.70	0.286	7.26	0.048	1.22	25, 150	7.6, 46
FIT-600-5/8	0.625	15.88	0.357	9.07	0.052	1.32	25, 150	7.6, 46
FIT-600-3/4	0.750	19.05	0.428	10.87	0.057	1.45	25, 100	7.6, 30.5
FIT-600-7/8	0.875	22.23	0.500	12.70	0.065	1.65	25, 100	7.6, 30.5
FIT-600-1IN	1.000	25.40	0.570	14.48	0.070	1.78	25, 100	7.6, 30.5
FIT-600-1-1/4	1.250	31.75	0.714	18.14	0.087	2.21	25, 100	7.6, 30.5
FIT-600-1-1/2	1.500	38.10	0.857	21.77	0.095	2.41	25, 100	7.6, 30.5
FIT-600-1-3/4	1.750	44.45	1.000	25.40	0.107	2.72	25, 75	7.6, 22.8
FIT-600-2IN	2.000	50.80	1.140	28.96	0.110	2.79	25, 75	7.6, 22.8
FIT-600-3IN	3.000	76.20	1.710	43.43	0.125	3.18	25, 50	7.6, 15.2



Heat-Shrink Tubing

FIT®-621 Heat Shrink Tubing

5.6:1 Shrink Ratio, Dual-Wall Flexible PO, Adhesive-Lined Inner Thick Wall

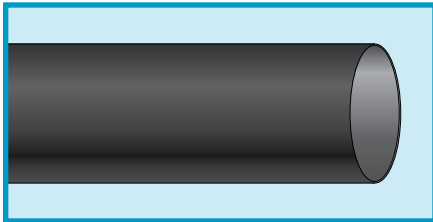

- High shrink ratios
- Heavy-duty adhesive lining
- Low water absorption
- Oil resistant
- Chemical resistant
- Abrasion resistant

Operating Temperature

- -55°C to +90°C

Shrink Temperature

- 121°C full recovery

Material

- Polyolefin

Color

Black

Physical Properties

- Tensile strength: 1200 psi (8.27 N/mm²)
- Elongation: 200% min
- Longitudinal change: -10%
- Specific gravity: 1.40
- Shelf life: 5 years at 18°C to 35°C

Chemical Properties

- Corrosive effect: none
- Fungus resistance: no growth
- Water absorption: 0.5% max
- Fluid resistance: 750 psi (5.17 N/mm²)
- Halogen free
- Lead free

Electrical Properties

- Dielectric strength: 200 V/mil (79 kV/cm²)
- Volume resistivity: 10¹³ ohm-cm

Availability

See table

Part No.	Supplied ID, Min.		Recovered ID, Max.		Recovered Wall Thickness, Nom.		Recovered Adhesive Wall Thickness, Min.		Availability, Qty, Cut Pieces at Length 6" (152 mm)
	Inch	mm	Inch	mm	Inch	mm	Inch	mm	
FIT-621-5/8	0.600	15.24	0.150	3.81	0.060	1.52	0.050	1.27	3, 10
FIT-621-1-1/4	1.250	31.75	0.220	5.59	0.060	1.52	0.050	1.27	3, 10
FIT-621-2	2.000	50.80	0.374	9.50	0.106	2.69	0.050	1.27	3, 10, 24
FIT-621-2-1/2	2.500	63.50	0.500	12.70	0.120	3.05	0.050	1.27	3, 10
FIT-621-3	3.000	76.20	0.748	19.00	0.140	3.56	0.050	1.27	3, 10
FIT-621-4	4.000	101.60	0.898	22.81	0.155	3.94	0.050	1.27	3, 10



Heat-Shrink Tubing

FIT®-650 Heat Shrink Tubing

2:1 Shrink Ratio, Flexible Fluoroelastomer

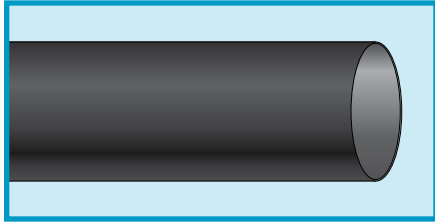

AMS-DTL-23053/13

- Excellent chemical resistance
- Wide temperature range
- Flexible
- Oil resistant
- Fuel resistant

Operating Temperature

- -40°C to +200°C

Shrink Temperature

- 130°C min.
- 175°C full recovery

Material

- Flexible fluoroelastomer

Colors

- Black

Physical Properties

- Tensile strength: 1200 psi (8.27 N/mm²)
- Elongation: 250% min
- Longitudinal change: ±20%
- Flammability: self-extinguishing
- Shelf life: 2 years at 18°C to 35°C

Chemical Properties

- Corrosive effect: none
- Fungus resistance: no growth
- Water absorption: 0.50% max
- Fluid resistance: 1200 psi (8.27 N/mm²)
- Lead free

Electrical Properties

- Dielectric strength: 200 V/mil (79 kV/cm)
- Volume resistivity: 10⁹ ohm-cm

Availability

100 ft (30.5 m)
Spools may contain multiple lengths

Part No	Supplied ID, Min.		Recovered ID, Max.		Recovered Wall Thickness, Nom.	
	Inch	mm	Inch	mm	Inch	mm
FIT-650-1/8	0.125	3.18	0.062	1.57	0.031	0.79
FIT-650-3/16	0.187	4.75	0.093	2.36	0.035	0.89
FIT-650-1/4	0.250	6.35	0.125	3.18	0.035	0.89
FIT-650-3/8	0.375	9.53	0.187	4.75	0.035	0.89
FIT-650-1/2	0.500	12.70	0.250	6.35	0.035	0.89
FIT-650-3/4	0.750	19.05	0.375	9.53	0.042	1.07
FIT-650-1	1.000	25.40	0.500	12.70	0.049	1.24
ST-650-1-1/2*	1.500	38.10	0.750	19.50	0.055	1.40

*Available in 50 ft (76 m) spools only.



Heat-Shrink Tubing

FIT®-700 Heat Shrink Tubing

3:1 Shrink Ratio, Heavy-Wall XLPO, Thermoplastic Adhesive Lined

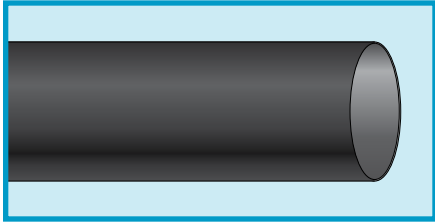

ANSI C119:1
UL 486
CSA 198

- Thermoplastic adhesive bonds to most materials
- Rated for 1 kV, 90°C continuous use
- Superior strength

Operating Temperature

- -55°C to +110°C

Shrink Temperature

- 120°C min.
- 120°C full recovery

Material

- Heavy-wall cross-linked polyolefin
- Thermoplastic adhesive

Color

- Black

Physical Properties

- Tensile strength: 2100 psi (14.48 N/mm²)
- Elongation: 600% min
- Longitudinal change: +1%/-10%

- Specific gravity: 1.10
- Flame retardant
- Shelf life: 25 years at 18°C to 35°C

Chemical Properties

- Corrosive effect: none
- Fungus resistance: no growth
- Water absorption: 0.10% max
- Fluid resistance: excellent
- UV resistant
- Lead free

Electrical Properties

- Dielectric strength: 500 V/mil (196.9 kV/cm)
- Volume resistivity: 10¹⁷ ohm-cm

Availability

Cut pieces (see table)

Part No.	Supplied ID, Min.		Recovered ID, Max.		Recovered Wall Thickness, Nom.		Recovered Adhesive Wall Thickness, Min.		Availability, Qty, Cut Pieces at Length
	Inch	mm	Inch	mm	Inch	mm	Inch	mm	
FIT-700-21	0.750	19.05	0.240	6.10	0.120	3.05	0.050	1.27	6
FIT-700-22	1.100	27.94	0.350	8.89	0.120	3.05	0.050	1.27	6
FIT-700-23	1.500	38.10	0.470	11.94	0.140	3.56	0.050	1.27	6
FIT-700-24	2.000	50.80	0.630	16.00	0.140	3.56	0.050	1.27	6
FIT-700-25*	3.000	76.20	1.250	31.75	0.160	4.06	0.050	1.27	6
FIT-700-26*	4.500	114.30	1.750	44.45	0.160	4.06	0.050	1.27	6

*Not UL or CSA listed



Heat-Shrink Tubing

FIT®-750 Heat Shrink Tubing

2:1 Shrink Ratio, XLPO, Adhesive Lined

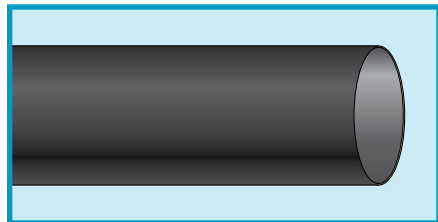

AMS-DTL-23053/4 Class 2
UL 224 VW-1
CSA 198

- General-purpose adhesive-lined tubing
- Total encapsulation
- Bonding to substrates

Operating Temperature

- -55°C to +110°C
- -55°C to +125°C (UL, CSA)

Shrink Temperature

- 110°C min.
- 110°C full recovery

Material

- Adhesive-lined cross-linked polyolefin

Color

- Black

Physical Properties

- Tensile strength: 1500 psi (10.34 N/mm²)
- Elongation: 200% min
- Longitudinal change: +1%/-5%

- All tubing flame tested
- Self-extinguishing within 1 minute
- Shelf life: 3 years at 18°C to 35°C

Chemical Properties

- Corrosive effect: none
- Fungus resistance: no growth
- Water absorption: 0.5% max
- Fluid resistance: 1000 psi (6.89 N/mm²)
- UV resistance
- Lead free

Electrical Properties

- 600 V (UL, CSA)
- Dielectric strength: 500 V/mil (197 kV/cm)
- Volume resistivity: 10¹² ohm-cm

Availability

See table

Part No.	Supplied ID, Min.		Recovered ID, Max.		Recovered Wall Thickness, Nom.		Recovered Adhesive Wall Thickness, Min.		Availability, Qty, Cut Pieces at Length
	Inch	mm	Inch	mm	Inch	mm	Inch	mm	
ST-302-1/8	0.125	3.18	0.063	1.60	0.027	0.69	0.002	0.05	25
ST-302-3/16	0.187	4.75	0.093	2.36	0.027	0.69	0.002	0.05	25
FIT-750-1/4	0.250	6.35	0.125	3.18	0.030	0.76	0.004	0.10	25
FIT-750-3/8	0.375	9.53	0.187	4.75	0.031	0.79	0.004	0.10	25
FIT-750-1/2	0.500	12.70	0.250	6.35	0.032	0.81	0.005	0.13	5
FIT-750-3/4	0.750	19.05	0.375	9.53	0.037	0.94	0.005	0.13	5
FIT-750-1IN	1.000	25.40	0.500	12.70	0.039	0.99	0.007	0.18	5
FIT-750-1-1/2	1.500	38.10	0.750	19.05	0.046	1.17	0.007	0.18	5



Heat-Shrink Tubing

FIT®-FABRIC Woven Fabric Heat-Shrink Tubing 2:1 Shrink Ratio

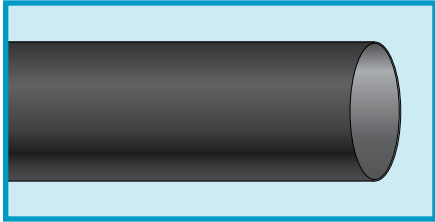

**UL 1441 (125°C)
MVSS 302**

- Excellent abrasion resistance
- Outstanding flexibility and durability
- Easy installation: cuts with scissors

Operating Temperature

- -40°C to +125°C

Shrink Temperature

- 80°C min.
- 135°C full recovery

Material

- Polyethylene-polyester fabric

Color

- Black

Physical Properties

- Flame retardant
- Shelf life: 25 years at 18°C to 35°C

Chemical Properties

- Corrosive effect: none
- Fungus resistance: no growth
- Lead free
- Halogen free
- UV resistant

Availability

See table

Spools may contain multiple lengths

Part No.	Supplied ID, Min.		Recovered ID, Max.		Recovered Wall Thickness, Nom.		Availability	
	Inch	mm	Inch	mm	Inch	mm	Ft	m
FIT-FAB-1	0.472	11.99	0.236	5.99	0.040	1.02	50, 200	15.2, 60.9
FIT-FAB-2	0.787	19.99	0.394	10.01	0.040	1.02	50, 200	15.2, 60.9
FIT-FAB-3	1.181	30.00	0.591	15.01	0.040	1.02	50, 200	15.2, 60.9
FIT-FAB-4	1.575	40.01	0.787	19.99	0.040	1.02	50, 200	15.2, 60.9
FIT-FAB-5	1.969	50.01	0.984	24.99	0.040	1.02	25, 100	7.6, 30.5
FIT-FAB-6	2.362	59.99	1.181	30.00	0.040	1.02	25, 100	7.6, 30.5
FIT-FAB-7	2.756	70.00	1.378	35.00	0.040	1.02	25, 100	7.6, 30.5



Heat-Shrink Tubing

FIT®-FLEX Highly Flexible Heat-Shrink Tubing
 1.7:1 Shrink Ratio, Cross-linked Silicone Rubber

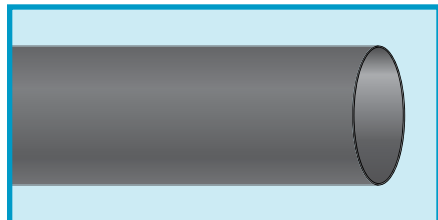

UL 224 VW-1

- Highly flexible over wide temperature range
- Scrape abrasion resistant
- Pliable

Operating Temperature

- -50°C to +200°C

Shrink Temperature

- 80°C min.
- 135°C full recovery

Material

- Cross-linked silicone rubber

Color

- Slate

Physical Properties

- Tensile strength: 870 psi (5.99 N/mm²)
- Elongation: 350% min
- Longitudinal change: -15%
- Specific gravity: 1.20
- Flammability: self-extinguishing
- Shelf life: 25 years at 18°C to 35°C

Chemical Properties

- Corrosive effect: none
- Fungus resistance: no growth
- Water absorption 1.0% max
- Lead free

Electrical Properties

- 600 V
- Dielectric strength: 200 V/mil (79 kV/cm)
- Volume resistivity: 10¹² ohm-cm

Availability

25 ft (7.6 m)
 100 ft (30.5 m)
 Spools may contain multiple lengths

Part No.	Supplied ID, Min.		Recovered ID, Max.		Recovered Wall Thickness, Nom.	
	Inch	mm	Inch	mm	Inch	mm
FIT-FLEX-2	0.165	4.19	0.071	1.80	0.055	1.40
FIT-FLEX-3	0.263	6.68	0.114	2.90	0.055	1.40
FIT-FLEX-5	0.394	10.01	0.173	4.39	0.055	1.40
FIT-FLEX-6	0.512	13.00	0.244	6.20	0.055	1.40
FIT-FLEX-9	0.757	19.23	0.354	8.99	0.059	1.50
FIT-FLEX-12	0.984	24.99	0.492	12.50	0.079	2.01
FIT-FLEX-20	1.378	35.00	0.748	19.00	0.079	2.01



Heat-Shrink Tubing

FIT®-CLEAR Heat-Shrink Tubing
2:1 Shrink Ratio, Cross-Linked PVDF

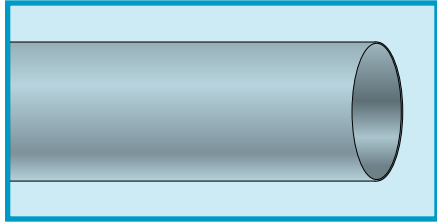

**AMS-DTL-23053/18 Class 1
UL 224 VW-1**

- Excellent heat and chemical resistance
- Mechanical abrasion and cut-through resistance

Operating Temperature

- -55°C to +175°C
- -55°C to +150°C (UL)

Shrink Temperature

- 150°C full recovery

Material

- Cross-linked polyvinylidene fluoride

Color

- Clear

Physical Properties

- Tensile strength: 3500 psi (24.13 N/mm²)
- Elongation: 200% min
- Longitudinal change: ±10%
- Specific gravity: 2.0
- Flame retardant
- Shelf life: 5 years at 18°C to 35°C

Chemical Properties

- Corrosive effect: none
- Fungus resistance: no growth
- Water absorption 0.5% max
- Fluid resistance: 2000 psi (13.79 N/mm²)
- Lead free

Electrical Properties

- 600 V (UL)
- Dielectric strength: 400 V/mil (158 kV/cm)
- Volume resistivity: 10¹¹ ohm-cm

Availability

See table

Spools may contain multiple lengths

Part No.	Supplied ID, Min.		Recovered ID, Max.		Recovered Wall Thickness, Nom.		Availability	
	Inch	mm	Inch	mm	Inch	mm	Ft	m
FIT-CLEAR-3/64	0.046	1.17	0.023	0.58	0.010	0.25	100	30.5
FIT-CLEAR-1/16	0.063	1.60	0.031	0.79	0.010	0.25	100	30.5
FIT-CLEAR-3/32	0.093	2.36	0.046	1.17	0.010	0.25	100	30.5
FIT-CLEAR-1/8	0.125	3.18	0.062	1.57	0.010	0.25	100	30.5
FIT-CLEAR-3/16	0.187	4.75	0.093	2.36	0.010	0.25	100	30.5
FIT-CLEAR-1/4	0.250	6.35	0.125	3.18	0.012	0.30	100	30.5
FIT-CLEAR-3/8	0.375	9.53	0.187	4.75	0.012	0.30	100	30.5
FIT-CLEAR-1/2	0.500	12.70	0.250	6.35	0.012	0.30	50	15.2
FIT-CLEAR-3/4	0.750	19.05	0.375	9.53	0.017	0.43	50	15.2
FIT-CLEAR-1IN	1.000	25.40	0.500	12.70	0.019	0.48	50	15.2
FIT-CLEAR-1-1/2	1.500	38.10	0.750	19.05	0.020	0.51	50	15.2
FIT-CLEAR-2IN	2.000	50.80	1.000	25.40	0.020	0.51	50	15.2



Heat-Shrink Tubing

CAP Molded Heat-Shrink End Caps
2:1 Shrink Ratio, Semirigid Polyolefin

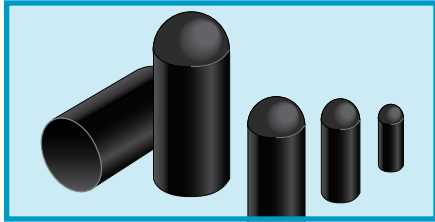

- Abrasion resistant
- Moisture resistant

Operating Temperature

- -55°C to +135°C

Shrink Temperature

- 135°C full recovery

Material

- Semirigid polyolefin

Color

- Black

Physical Properties

- Tensile strength: 2500 psi (1.76 N/mm²)
- Elongation: 300% min
- Recovered parts may have angularity of 30° to 45°
- Specific gravity: 1.25
- Flammability: self-extinguishing
- Shelf life: 25 years at 18°C to 35°C

Chemical Properties

- Corrosive effect: none
- Fungus resistance: no growth
- Water absorption 0.1% max
- UV resistant
- Lead free

Electrical Properties

- Dielectric strength: 700 V/mil (276 kV/cm)
- Volume resistivity: 10¹⁶ ohm-cm

Availability

25-piece packages

Part No.	Supplied ID, Min.		Recovered ID, Max.		Recovered Wall Thickness, Nom.		Recovered Length, Nom.	
	Inch	mm	Inch	mm	Inch	mm	Inch	mm
CAP-21	0.200	5.08	0.080	2.03	0.040	1.02	0.900	22.86
CAP-22	0.290	7.37	0.130	3.30	0.050	1.27	1.000	25.40
CAP-23	0.400	10.16	0.180	4.57	0.060	1.52	1.200	30.48
CAP-24	0.600	15.24	0.250	6.35	0.070	1.78	1.600	40.64
CAP-25	0.810	20.57	0.370	9.40	0.080	2.03	2.400	60.96
CAP-26	1.000	25.40	0.450	11.43	0.090	2.29	2.700	68.58
CAP-27	1.550	39.37	0.710	18.03	0.100	2.54	3.600	91.44

Heat-Shrink Tubing

SPC Heat Shrink Tubing

3:1 Shrink Ratio, XLPO, Heavy-Wall Thermoplastic Bonding Layer

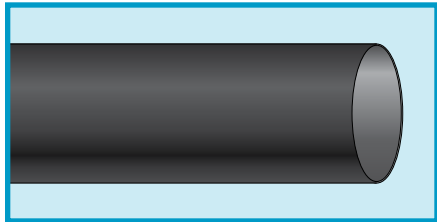

AMS DTL-23053/15 Class 1

- Adhesive lined for sealing
- Thick wall for extra abrasion resistance
- Rated to 1 kV

Operating Temperature

- -55°C to +110°C

Shrink Temperature

- 120°C min.

Material

- Cross-linked polyolefin

Color

- Black

Physical Properties

- Tensile strength: 2400 psi (138 N/mm²)
- Elongation: 475% min
- Longitudinal change: +1%/-10%
- Specific gravity: 1.28
- Flame retardant, self-extinguishing
- Shelf life: 25 years at 18°C to 35°C

Chemical Properties

- Corrosive effect: none
- Fungus resistance: no growth
- Water absorption: 0.02%
- Fluid resistance: pass
- UV resistant
- Lead free

Electrical Properties

- Dielectric strength: 500 V/mil (197 kV/cm)
- Volume resistivity: 10¹⁵ ohm-cm

Availability

Sold in individual pieces
 6 in. (0.1 m)
 12 in. (0.3 m)
 48 in. (1.2 m) bulk

Part No.	Supplied ID, Min.		Recovered ID, Max.		Recovered Wall Thickness, Nom.		Recovered Adhesive Wall Thickness, Min.	
	Inch	mm	Inch	mm	Inch	mm	Inch	mm
SPC-400*	0.400	10.16	0.150	3.81	0.060	1.52	0.050	1.27
SPC-800*	0.800	20.32	0.200	5.08	0.060	1.52	0.050	1.27
SPC-110*	1.100	27.94	0.375	9.53	0.105	2.67	0.050	1.27
SPC-150	1.500	38.10	0.500	12.70	0.120	3.05	0.050	1.27
SPC-200	2.000	50.80	0.750	19.05	0.120	3.05	0.050	1.27
SPC-300	3.000	76.20	1.000	25.40	0.120	3.05	0.050	1.27

*Availability includes 6 in. (0.1 m) lengths.



Heat-Shrink Tubing

SPCM Heat Shrink Tubing

3:1 Shrink Ratio, XLPO, Medium Wall, Thermoplastic Bonding Layer

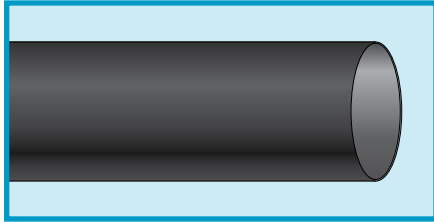

Operating Temperature

- -55°C to +200°C

Shrink Temperature

- 120°C min.

Material

- Cross-linked polyolefin

Color

- Black

Physical Properties

- Tensile strength: 2400 psi (1.38 N/mm²)
- Elongation: 475% min
- Longitudinal change: +1%/-10%
- Specific gravity: 1.25
- Self-extinguishing
- Shelf life: 25 years at 18°C to 35°C

Chemical Properties

- Corrosive effect: none
- Fungus resistance: no growth
- Water absorption: 0.02%
- Fluid resistance: pass
- UV resistant
- Lead free

Electrical Properties

- Dielectric strength: 500 V/mil (197 kV/cm)
- Volume resistivity: 10¹⁵ ohm-cm

Availability

- Sold in individual pieces
- 6 in. (0.1 m)
 - 12 in. (0.3 m)
 - 48 in. (1.2 m)

AMS DTL-23053/15 Class 2

- Adhesive lined for sealing
- Medium wall for abrasion resistance
- Rated to 1 kV

Part No.	Supplied ID, Min.		Recovered ID, Max.		Recovered Wall Thickness, Nom.		Recovered Adhesive Wall Thickness, Min.	
	Inch	mm	Inch	mm	Inch	mm	Inch	mm
SPCM400*	0.400	10.16	0.150	3.81	0.050	1.27	0.040	1.02
SPCM800*	0.800	20.32	0.220	5.59	0.060	1.52	0.040	1.02
SPCM110*	1.100	27.94	0.375	9.53	0.065	1.65	0.040	1.02
SPCM130	1.300	33.02	0.375	9.53	0.065	1.65	0.040	1.02
SPCM150	1.500	38.10	0.500	12.70	0.080	2.03	0.040	1.02
SPCM170	1.700	43.18	0.500	12.70	0.100	2.54	0.040	1.02
SPCM200	2.000	50.80	0.750	19.05	0.100	2.54	0.040	1.02
SPCM300	3.000	76.20	1.000	25.40	0.100	2.54	0.040	1.02

*Availability includes 6 in. (0.1 m) lengths.



Heat-Shrink Tubing

FIT®-PRINT Heat-Shrinkable Identification System

3:1 Shrink Ratio, XLPO

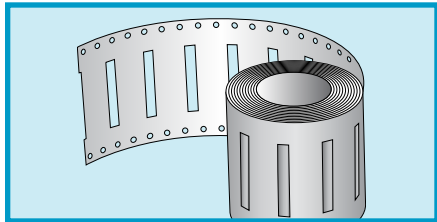

UL 224
CSA 198
MIL-STD-202F Method 215J

- Permanent, smear-resistant marking
- Identification for cable or harness assemblies

Operating Temperature

- -30°C to +105°C

Shrink Temperature

- 90°C min.
- 125°C full recovery

Material

- Cross-linked polyolefin

Colors

- White, yellow

Physical Properties

- Tensile strength: 1160 psi (8.0 N/mm²)
- Elongation: 150% min

- Longitudinal change: 20%
- Flame retardant
- Shelf life: 3 years at 18°C to 35°C

Chemical Properties

- Corrosive effect: none
- Fungus resistance: no growth
- Water absorption: 0.5%

Electrical Properties

- Dielectric strength: 20 V/mil (7.9 kV/cm)
- Volume resistivity: 10¹⁴ ohm-cm

Availability

250 tubing pieces per package

Part No	Range			Supplied ID, Min.		Recovered ID, Max.		Recovered Wall Thickness, Nom.	
	AWG	Inch	mm	Inch	mm	Inch	mm	Inch	mm
FIT-PRINT-1/8	22 - 16	0.344 - 1.374	8.74 - 34.90	0.125	3.18	0.042	1.07	0.023	0.58
FIT-PRINT-1/4	16 - 8	1.374 - 3.264	34.90 - 82.92	0.250	6.35	0.083	2.11	0.023	0.58
FIT-PRINT-1/2	8 - 2	3.264 - 6.543	82.92 - 166.19	0.500	12.70	0.166	4.22	0.023	0.58
FIT-PRINT-1	2 - 4/0	6.543 - 10.2	166.19 - 259.08	1.000	25.40	0.333	8.46	0.023	0.58

To economically meet the wire identification needs of the electronic interconnect, industrial, computer office automation, marine, and electrical markets, FIT-PRINT sleeves allow smear-resistant, permanent identification. The sleeves, available in white or high-visibility bright yellow, feed directly into dot matrix printers (high carbon content ribbon recommended). A standard ball-point pen may also be used.



Heat-Shrink Tubing

FIT®-KIT

Assorted Heat-Shrink Tubing



- For use in R&D labs, engineering development, and maintenance departments

FIT-KIT-1 for General-Purpose Indoor Applications

Tubing supplied in 6" (15.2 cm) lengths unless otherwise noted.

Family	Material	Sizes	Range	Total Quantity
FIT-105	PVC	9	3/64" - 3/4"	18
FIT-221	XLPO	9	3/64" - 3/4"	19
FIT-295	SR-XLPO	8	3/64" - 1/2"	12
FIT-300	XLPO	5	1/8" - 1/2"	10
FIT-350	PVDF	7	3/64" - 3/8"	14
FIT-CRIMP	Nylon	22 - 10 AWG	—	3 pc*
Caps	XLPO	22, 23, 24 AWG	—	6 pc

*1 each of FIT-CRIMP 1, 2, and 3.

FIT-KIT-2 for General-Purpose Indoor and Outdoor Applications

Tubing supplied in 6" (15.2 cm) lengths unless otherwise noted.

Family	Material	No. of Sizes	Range	Total Quantity
FIT-105	PVC	9	3/64" - 3/4"	18
FIT-221	XLPO	9	3/64" - 3/4"	19
FIT-295	SR-XLPO	8	3/64" - 1/2"	12
FIT-300	XLPO	5	1/8" - 1/2"	10
FIT-321	Adhesive-Lined XLPO	2	1/4" - 1/2"	16, 24*
FIT-350	PVDF	7	3/64" - 3/8"	14
FIT-400	FEP	6	24 - 12 AWG	22
FIT-500	PTFE	5	26 - 18 AWG	17
FIT-600	Chlorinated PO	5	1/4" - 1"	8
FIT-700	Thermoplastic Adhesive-Lined XLPO	2	21 - 22	2
FIT-750	Adhesive-Lined XLPO	1	3/8"	10*
FIT-CRIMP	Nylon	22 - 10 AWG	—	3 pc**
Caps	XLPO	22, 23, and 24	—	6 pc

*1"/25.4 mm length.

**1 each of FIT-CRIMP 1, 2, and 3.

FIT-KIT-7 for General-Purpose Indoor and Outdoor Applications

Tubing supplied in 6" (15.2 cm) lengths unless otherwise noted.

Family	Material	No. of Sizes	Range	Total Quantity
FIT-105	PVC	7	1/16" - 1/2"	14
FIT-221	XLPO	7	1/16" - 1/2"	28
FIT-260	XLPO (Ground Lead)	3	1/8" - 1/2"	6
FIT-300	XLPO	4	3/8" - 1/2"	8
FIT-321	Adhesive-Lined XLPO	3	1/8" - 1/2"	6
FIT-350	PVDF	7	1/6" - 1/2"	14
FIT-400	FEP	7	24 - 12 AWG	14
FIT-750	Adhesive-Lined XLPO	5	1/4" - 1"	10
FIT-CRIMP	Nylon	22 - 10 AWG	—	12 pc*

*4 each of FIT-CRIMP 1, 2, and 3.

Heat-Shrink Tubing

FIT®-MGKIT-1

Convenient Kit with FIT Minigun and FIT-221 Variety Pack



FIT Minigun Characteristics

- UL 499
- To 300°C nozzle temperature
- 6 ft (1.83 m) power cord
- 10.3 oz (0.39 kg) net weight
- Workbench storage loop included
- 120 V
- 350 W
- 3 A
- Color: blue

FIT-221-R Variety Kit

- UL 224
- CSA 198
- AMS-DTL-23053/5 Class 1
- 60 6" (15.2 cm) pieces in five sizes and various colors
- Cross-linked polyolefin
- 2:1 shrink ratio

FIT-MGKIT-1 Contents

Part No.	Description	Quantity
FIT MINIGUN	Lightweight, portable heat gun	1
FIT-221-R	FIT-221R Variety Pack	1 kit/60 pieces

FIT-221-R Kit Contents

	Tubing Size		Number of 6" (15.2 cm) Pieces					
	Inch	Mm	Black	White	Red	Blue	Yellow	Green
FIT-221-1/8	0.125	3.18	4	3	2	2	2	1
FIT-221-3/16	0.187	4.75	4	3	2	2	2	1
FIT-221-1/4	0.250	6.35	4	3	2	2	2	1
FIT-221-3/8	0.375	9.53	3	2	1	1	1	1
FIT-221-1/2	0.500	12.70	3	2	1	1	1	1



Heat-Shrink Tubing

FIT®-CRIMP Heat-Shrinkable Crimp Splices

2:1 Shrink Ratio, Nylon

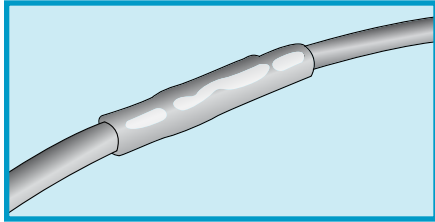

UL ZMVV

Operating Temperature

- -55°C to +125°C

Materials

- Heat-shrinkable nylon
- Polyamide-based adhesive
- Tin-plated copper base metal

Physical Properties

- Shelf life: 25 years at 18°C to 35°C
- Not flame retardant

Chemical Properties

- Solvent resistance: isopropyl alcohol, trichloroethylene, gasoline, battery acid, diesel fuel, motor oil, anti-freeze, brake fluid, 5% salt water

Availability

- 100-piece packages
- 500-piece packages

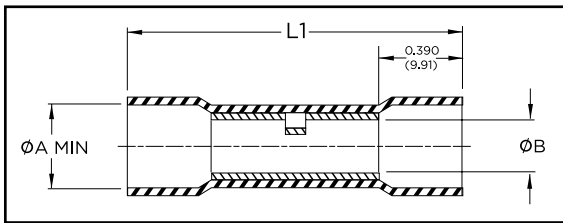

Part No.	Wire Range		Color	Length		Supplied ID, Min.			Recovered ID, Max.		
	AWG	mm ²		L1		A	B	A			
				Inch	mm	Inch	mm	Inch	mm	Inch	mm
FIT-CRIMP 1	22 - 18	0.26 - 0.96	Red	1.50	38.10	0.170	4.32	0.058	1.47	0.055	1.40
FIT-CRIMP 2	16 - 14	1.04 - 2.62	Blue	1.50	38.10	0.197	5.00	0.092	2.34	0.080	2.03
FIT-CRIMP 3	12 - 10	2.62 - 6.64	Yellow	1.70	43.18	0.255	6.48	0.138	3.51	0.110	2.79

Alpha's heat-shrinkable pre-insulated crimp splices completely seal electrical connections from corrosion caused by water, salts, and other contaminants. Unlike conventional splices, these adhesive-lined butt connectors provide a strong reinforced connection. They are lightweight and easy to install, too.

Simply insert the wires. The sleeve's transparent nylon insulation lets you inspect wire location and position your crimping tool fast.

Crimp the splice and then shrink and seal it with a common heat gun or other heat source. Reliable sealing plus quick and easy installation add up to protection you can count on whenever wire splices are required, including automobile and truck wiring, outdoor electrical equipment, marine equipment, telecommunications equipment, recreational equipment, and household appliances.



Heat-Shrink Tubing

FIT®-SLV Soldering Sleeves

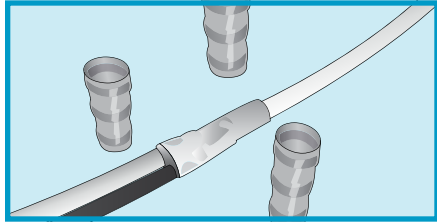

ANSI J-STD-004
ANSI J-STD-006
NAS 1745

Operating Temperature

- -55°C to +105°C (SLV 12 - 16)
- -55°C to +125°C (SLV 22 - 26)

Sleeve Color

- Transparent blue

Materials

- PVDF heat-shrinkable sleeve

Solder Preform:

- 105°C Series: 51.2% tin, 30.6% lead, 18.2% cadmium (143°C melting temperature)
- 125°C Series: 63% tin, 37% lead (183°C melting temperature)

Physical Properties:

- Shelf life: 25 years at 18°C to 35°C

Availability

- 25-piece packages
- 100-piece packages

Part No.		Dimensions					
		D1 min.		D min.		L nom.	
105°C	125°C	Inch	mm	Inch	mm	Inch	mm
FIT-SLV-12	FIT-SLV-22	0.125	3.18	0.110	2.79	0.625	15.88
FIT-SLV-14	FIT-SLV-24	0.200	5.08	0.180	4.57	0.625	15.88
FIT-SLV-16	FIT-SLV-26	0.300	7.62	0.280	7.11	0.750	19.05

Alpha's FIT-SLV soldering sleeve is a one piece, shield ground termination system featuring a strong, low-cost soldered connection that is completely insulated and encapsulated. It consists of a heat-shrinkable thermoplastic sleeve containing a precisely engineered preform of fluxed solder and thermoplastic

inserts at each end. When placed over a cable shield and heated, the solder melts and flows, connecting the ground lead and shield. The outer sleeve shrinks and the thermoplastic inserts melt, encapsulating the termination. The result is a perfectly soldered, strain-relieved and environmentally protected termination.

A solder preform ensures exact quantity of solder and flux, producing optimum solder connections for maximum strength and lowest voltage drop. Transparent heat-shrinkable insulating sleeve allows inspection of termination, and provides long-life strain relief. Meltable inserts insure complete environmental protection.





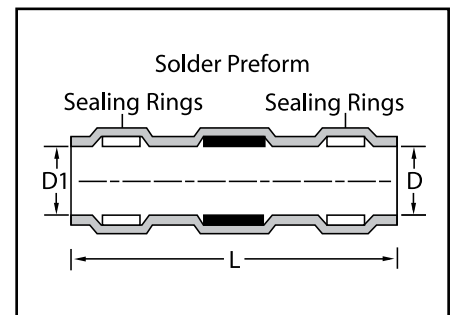
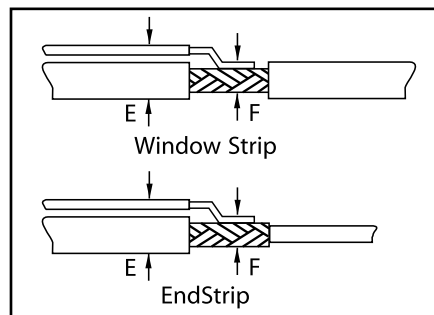



Selection Guide

- 1 Measure maximum diameter (E) and minimum diameter (F) of combined cable and ground lead.
- 2 Find appropriate Alpha part number and sleeve size in the cable and sleeve dimensions chart.



Heat-Shrink Tubing

FIT® Heat Guns

	FIT-GUN-1	FIT-GUN-3	FIT-Minigun
			
Temperature, Low	60°C (140°F)	316°C (600°F)	—
Temperature, High	566°C (1050°F)	510°C (950°F)	300°C (572°F)
Temperature Selection	Slider switch: Off, Low, Medium, High	Slider switch: Off, Low, High	Rocker switch: Off, On
Power	1400 W	1300 W	350 W
Voltage	120 VAC/60 Hz	120 VAC/60 Hz	120 VAC/60 Hz
Current	11.6 A	10.0 A	3 A
Power Cord Length	6.5 ft (2 m)	6.5 ft (2 m)	6 ft (1.8 m)
Net Weight	2.2 lb (1 kg)	1.6 lb (0.68 kg)	10.3 oz (0.39 kg)
Color	Black/gray	Black/gray	Blue
Nozzle Attachments	Reflector nozzle	—	Workbench loop
Approvals	UL 499  	UL 499  	UL 499 
Part No.	FIT-GUN1	FIT-GUN3	FIT-MG1

FIT[®] Wire Management



FIT® Wire Management

Better wire management means better harnesses



Bringing order to wire harnesses and cable routing means a system that is more reliable, easier to fabricate, and simpler to maintain. Our woven sleeves are tough and flexible. For additional resistance to chemicals, oils, and solvents, our flexible tubing offers exceptional performance and operates at temperatures as high as 260°C. Our braided shields are effective and easy to use for additional EMI protection or a ground connection.

Neatness counts

As a leader in premium products, Alpha Wire knows wire and cable. And we know the challenges you face in creating harnesses, routing, and combating noise. Our FIT wire management products are designed to tame the most unruly applications.

Harnessing

Make any wire harness organized, manageable, and neat with our tubing, sleeving, spiral wrap tubing, zipper tubing, and lacing tape. Our unique ZIP-GRP expandable, enclosure sleeving allows easy re-entry and unlimited wire and cable break outs with its hook and loop fastener system.

Shielding

Add shielding easily and quickly. We offer flat, round, and oval braided shielding for additional protection against EMI and for grounding protection. Our copper foil shielding tape is backed with a highly conductive, pressure-sensitive adhesive for use in a wide variety of EMI/RFI shielding applications in cable and connector assemblies.

Routing

Get the advantages of conduit in a flexible non-metallic, liquid-tight tubing and connection system that protects wire, copper cable, and fiber-optic cable in factories, offices, or underground installations. Use our watertight tubing to replace rigid raceways where flexibility, re-entry, or re-usability is required. Additionally, Alpha offers split looms to provide a convenient solution for your routing needs.

FIT® Wire Management

Better wire management means better harnesses

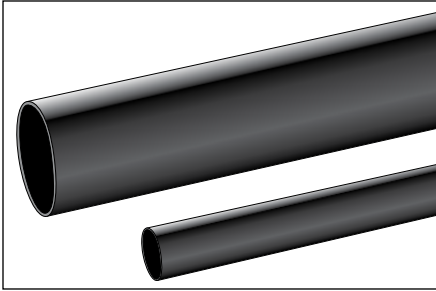

PVC-105

PVC tubing is the workhorse choice for protecting, organizing, and routing cables.

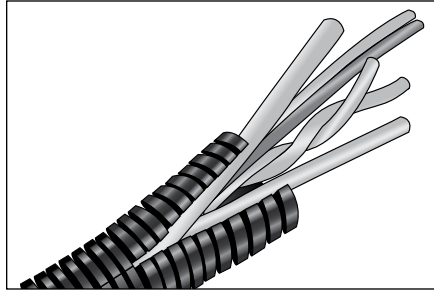

Convoluted Slit Loom Tubing and Tee Connector Fittings

Type 492 Tubing

Type 493 Fittings

Flexible polyethylene loom material permits fast, easy installations and protection of harness and cable assemblies. The loom is slit full length so that it slides over the completed wire assembly easily, but closes after installation to protect the wire bundle. The slit allows for the wires to break out at any point along the cable length for custom installation. Companion snap-on connectors provide simple, clean cable junctions.

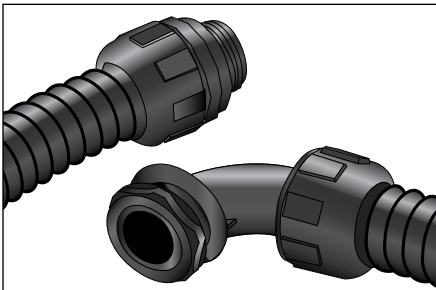

Flexible Liquid-Tight PVC Tubing and Nylon Connectors

FNT Tubing

SLC and RLC Connectors

FNT PVC tubing system of wire management products for electronic and electrical wire protection provides maximum flexibility and can be used in extremely tight quarters. The tubing is excellent for general applications where maximum flexibility is required or in areas where movement, vibration, or flexing is a problem.



Zipper Tubing™

ZIP-41

Protect wire, cables, and harnesses. Alpha Zipper Tubing provides a professional finish to wiring installations by eliminating exposed wiring and providing added protection against flame, chemicals, and abrasion. With Zipper Tubing, it's possible to isolate any group of wires or cables quickly and easily, without the bother of tape wrapping. Zipper Tubing is an ideal jacketing material for use in harsh environments for production or repair of harness assemblies. Each package contains two plastic sliders.

FIT® Wire Management

Better wire management means better harnesses

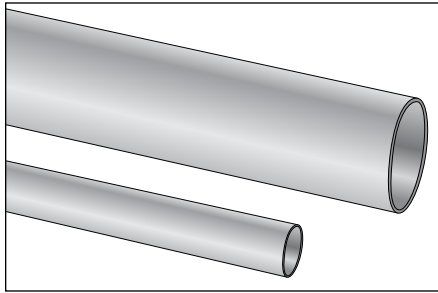

Flexible PTFE Tubing

TFT-200 Thin-Wall Tubing

TFT-250 Standard-Wall Tubing

To improve the reliability of cable harnesses, PTFE tubing provides a heat and abrasion resistant wire insulator under the most adverse conditions. With an unmatched temperature range, exceptional abrasion resistance, and excellent dielectric properties, it maintains flexibility over its entire temperature range.

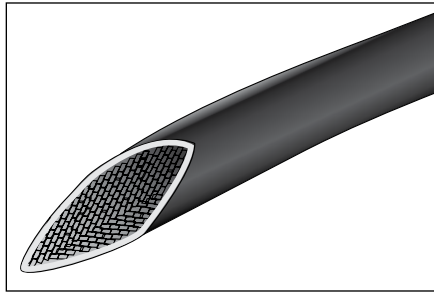

PVC-Coated Fiberglass Sleeving

PIF-130

PIF-130 sleeving is a woven fiberglass braid impregnated with a heat-resistant, extremely tough, abrasion-resistant and flexible plastic insulation. The fiberglass is treated to remove all organic matter and resist fraying. The sleeving is completely compatible with all insulation and conductor types.

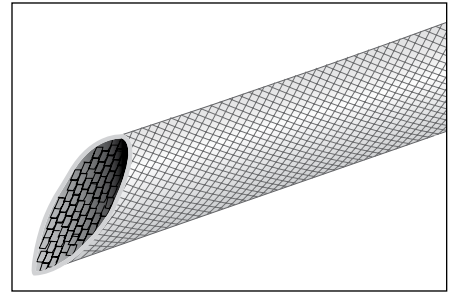

Uncoated Fiberglass Sleeving

PIF-240

PIF-240 sleeving is extremely flexible and abrasion resistant. It is ideal for applications requiring operation up to 648°C. It is heat treated to remove all organic matter, and it is completely compatible with all insulation and conductor types.

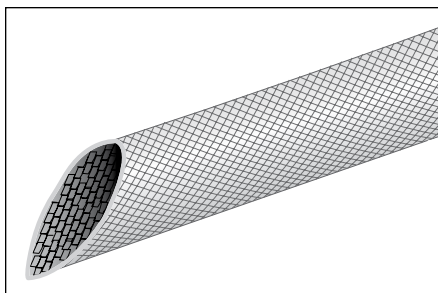

Acrylic-Coated Fiberglass Sleeving

AF-155

AF-155 is a specially designed fiberglass sleeving coated with a thermally stable, flexible, acrylic resin for wire and cable protection in electrical equipment. The most economical and versatile of all coated sleeving products, it offers high heat resistance, extreme flexibility, and resistance to cracking, abrasion, cut-through, and chemicals.

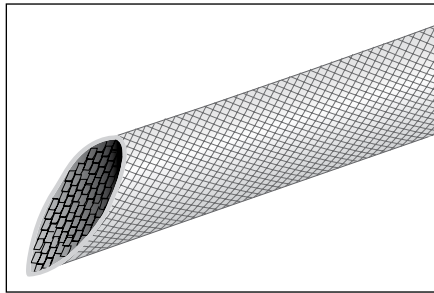

Silicone-Coated Fiberglass Sleeving

PIF-200, SF-200

PIF-200 and SF-200 sleeving offers high heat and superior electrical characteristics in a closely woven, braided fiberglass, uniformly coated with silicone rubber. It provides low temperature flexibility to -70°C and heat protection to 200°C. The fiberglass sleeving material is heat-set, cuts cleanly, and will not fray. It is easy to “pushback” and form over components, connections, and cables.

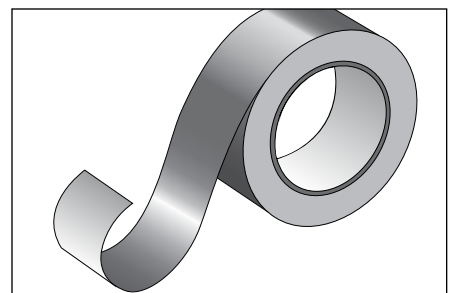

CST Series

The pressure-sensitive adhesive contains a uniform dispersion of unique oxidation-resistant conductive particles that produce very low resistance through the tape. This feature results in shielding performance approximately 5 dB better than other metal foil shielding tapes.

FIT® Wire Management

Better wire management means better harnesses

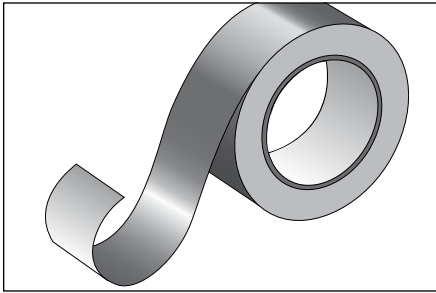

Self-Fusing Silicone Tape

Where a masking wrap or permanently resilient insulation seal is necessary, self-adhering silicone tape is made of special unsupported silicone rubber compound that readily adheres to itself when wrapped under tension and fuses to form a homogenous mass within 24 hours at room temperature or 4 hours at 177°C. The self-adhering silicone is protected with a polyester or polyethylene liner to prevent contamination and blocking.

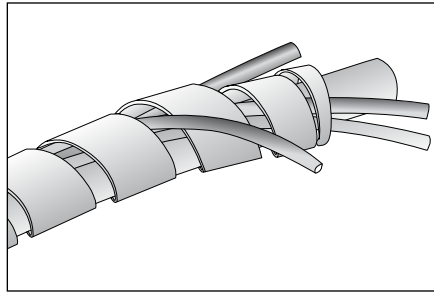

Spiral Wrap Tubing SW

Spiral wrap tubing simplifies wire harnessing, cabling, and bundling. Alpha's SW tubing wraps tightly to the wire and cable being bundled, yet is flexible and simple to apply. All types maintain flexibility even when bent around sharp edges. Breakouts or tapoff connections may be made through the openings of the wrap. SW spiral wrap is constructed from several semirigid tubing materials and then cut on a continual spiral.

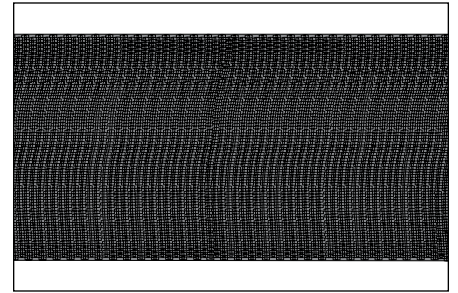

Expandable Braided Polyester Sleeving GRP-110, GRP-120

GRP-110/120 is a lightweight, expandable woven polyester sleeving that offers high flexibility with high resistance to abrasion and cut-through. The open weave allows for a great range of expansion of the sleeving diameter, thus ensuring ease of installation and gripping action over a wide range of shapes and sizes. GRP sleeving is an ideal protective sleeve for wire bundles, harnesses, pneumatic hoses, hydraulic lines, and highly polished or threaded machine parts.

To prevent fraying of ends, GRP-110 and GRP-120 should be cut/sealed with a hot knife.

FIT® Wire Management

Better wire management means better harnesses

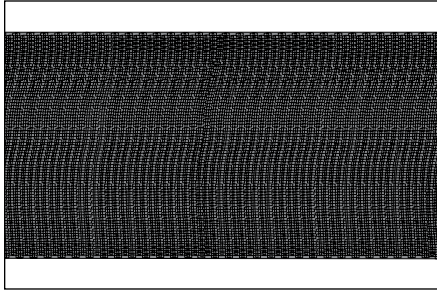

Non-Fraying, Expandable Braid Sleeving

GRP-110NF, GRP-120NF

GRP-110NF/120NF sleeving cuts cleanly and fray-free with scissors, with no hot knife required. It is a lightweight, expandable woven polyester sleeving that offers high flexibility with high resistance to abrasion and cut-through. The open weave allows for a great range of expansion of the sleeving diameter, thus ensuring ease of installation and gripping action over a wide range of shapes and sizes. GRP sleeving is an ideal protective sleeve for wire bundles, harnesses, pneumatic hoses, hydraulic lines and highly polished or threaded machine parts.



Wrappable Sleeving

GRP-130 and GRP-130NF

A unique split, semirigid braided construction allows GRP-130 and GRP-130NF sleeving to be installed quickly and easily. The lateral split opens up to accommodate a wide variety of bundling requirements, and then closes around the entire installation without the need for any additional fasteners. The sleeving bends to a tight radius open and, unlike full rigid tubing, will not impair or affect the flexibility of harnesses.

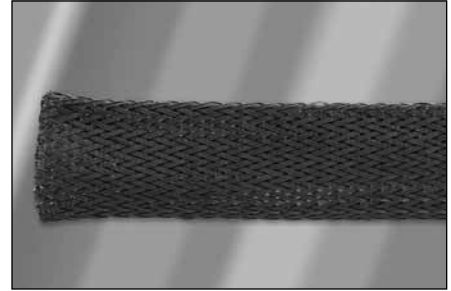

Advanced Protection Expandable Sleeving

GRP-160

This heavy-duty, flexible sleeving is extremely versatile in any industrial application requiring abrasion protection without sacrificing flexibility or durability. GRP-160 sleeving is economical and easy to use, cutting cleanly with a hot knife, and expanding up to 50% for easy installation over plugs and connectors. It resists fuels, UV, solvents, salt water, and most chemicals.

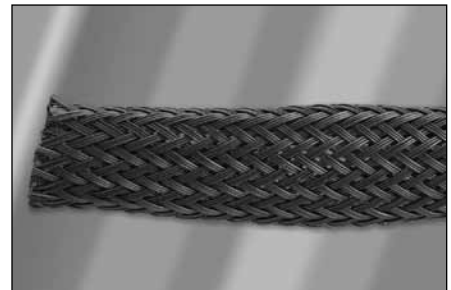

Advanced Chemical-Resistant Expandable Sleeving

GRP-170

GRP-170 is lightweight sleeving, resistant to high temperatures and virtually impervious to solvents. The sleeving resists all known solvents below 200°C chemical resistance, is inert to steam, strong bases, fuels, and acids, and offers high temperature stability, low moisture absorption, excellent dimensional stability and ultra-low wear.

FIT® Wire Management

Better wire management means better harnesses

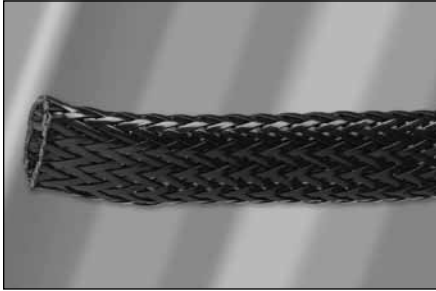

Maximum Protection Expandable Sleeving

GRP-180

For a thick abrasion guard offering extreme protection against abrasion and cut-through on hoses and cables exposed to harsh conditions. GRP-180 provides fuller coverage for increased resistance to abrasion and penetration, and still expands for easy installation over long lengths. The braided construction allows moisture dissipate quickly to prevent rot and fungus.

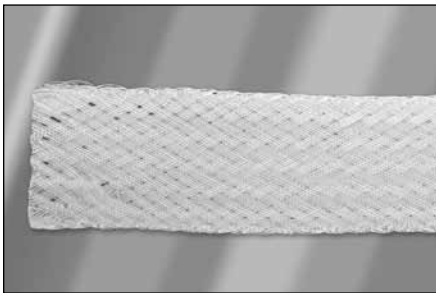

Extreme Performance Expandable Sleeving

GRP-200

GRP-200 sleeving uses PTFE to allow the highest levels of performance, including resistance to chemicals, flame, and high temperatures. Thermal stability and low outgassing make it suited to aerospace, military, and high-tech applications. GRP-2000 sleeving is suitable for plenum applications.

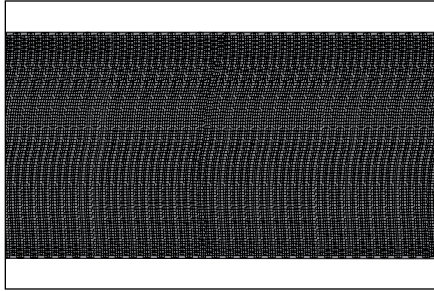

Expandable Polyester Braided Sleeving

XS-100HD

Spirally cut sleeving simplifies wiring, cabling, harnessing, and bundling where breakout or re-entry is required.

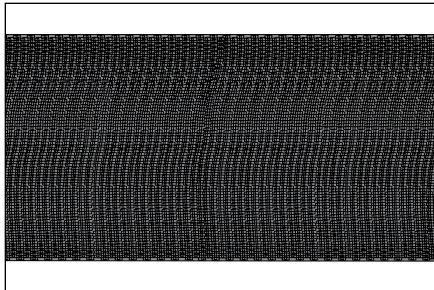

Braided Sleeving

XS-200N

Durable overbraiding for military and commercial cable assemblies protects against abrasion, mildew, and aging. Type XS-200N nylon braided self-fitting cable sleeving has been designed to cover and protect both round and flat cable assemblies. The variety of sizes and self-fitting features make selection easy for solving many of the cable assembly design problems found in electronic, electrical, aerospace, process control, and robotic-automation equipment.

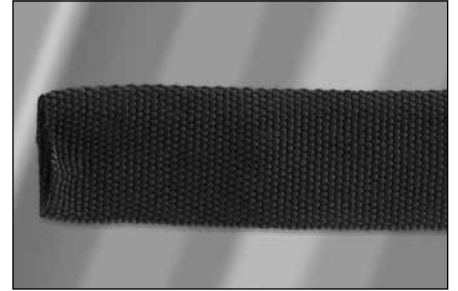

Abrasion-Resistant Nylon Sleeving

XS-300

Tightly woven nylon, with a 45-mil wall thickness, makes XS3000 sleeving the perfect solution for protecting cables, hoses and ropes from weather, sunlight and abrasion damage. The sleeving is resistant to chemicals, UV damage and rot, making it suitable for continuous outdoor use under all weather conditions. The flexible sleeving cuts with a scissor and slides easily over any application.

FIT® Wire Management

Better wire management means better harnesses

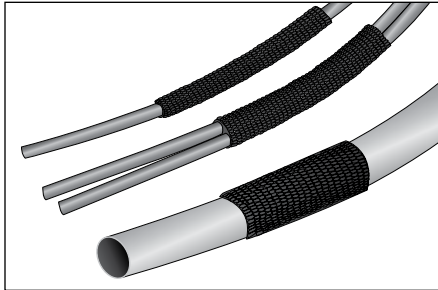

Expandable Polyester Webbed Sleeving

ZIP-GRP

ZIP-GRP expandable webbing offers superb flexibility and high tensile strength while providing added protection against flame, chemicals, and abrasion. With its hook and loop fastening, wires, cable assemblies, and wire harnesses are always accessible and can be easily opened for any number of breakouts. To prevent fraying of ends, ZIP-GRP should be cut/sealed with a hot knife.



Lacing Tape

Alpha lacing tapes offer high tensile strength and knot retention. Designed to allow a wider contact area with the insulation so that it remains in place, lacing tape is flexible and easy on the assembler's hands. Once knotted, tape resists slipping and does not increase diameter of harness. Nylon has excellent tensile strength and resists acids, abrasion, flame, and fungus. Polyester has all the characteristics of nylon, but has better resistance to acids, and no appreciable discoloration.

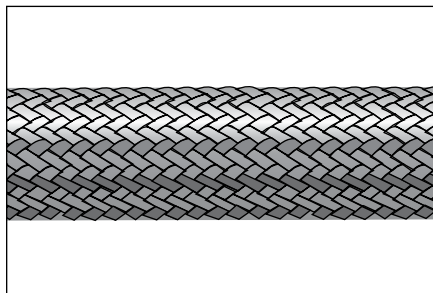

Tinned and Silver-Plated Copper Braid

A tight weave of multistrand, soft drawn copper wire, either tinned or silver plated, copper braid is an ideal shielding material for short-run cables providing easy radial termination. In retrofit applications, provides additional shielding efficiency. Tinned copper flat braid, used as a ground strap, provides an excellent, low-resistance ground path.

FIT® Wire Management

Multipurpose PVC Tubing

PVC-105

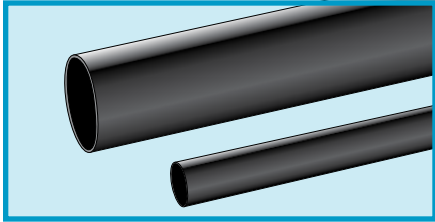

UL 224 VW-1
CSA 198
MIL-I-631D Type F, Form U,
Subform Ua, Grade C
ASTM D922

- Flexible wire protection for harnesses and ground straps
- Resistance to heat, oil, and abrasion

Operating Temperature

- -20°C to +105°C

Colors

- Size #24 to 1-1/2 inches: Black, clear
- 2 Inches to 2-1/2 inches: Black

Physical Properties

- Tensile strength: 2780 psi (19.17 N/mm²)
- Elongation: 260%
- Specific gravity: 1.32
- Flammability: UL 224 VW-1

Chemical Properties

- Corrosive effect: non-corrosive
- Fungus resistance: no growth
- UV stable
- Lead free

Electrical Properties

- Dielectric strength: 870 V/mil (343 kV/cm)
- Volume resistivity: 2 x 10¹⁴ ohm-cm
- UL voltage rating
 Sizes #24 to #1: UL rated 300 V
 5/16 to 2 inches: UL rated 600 V

Availability

- See table
- PVC-105-24 to PVC-105-1 are available air spooled on the largest put-ups only

Part No.	Inside Diameter, Min.		Inside Diameter, Max.		Wall Thickness, Nom.		Standard Put-Ups	
	Inch	mm	Inch	mm	Inch	mm	Ft	m
PVC-105-24	0.022	0.56	0.027	0.69	0.012	0.30	1000	305
PVC-105-22	0.025	0.64	0.032	0.81	0.012	0.30	100, 1000	30.5, 305
PVC-105-20	0.032	0.81	0.039	0.99	0.016	0.41	1000	305
PVC-105-19	0.036	0.91	0.044	1.12	0.016	0.41	1000	305
PVC-105-18	0.040	1.02	0.049	1.24	0.016	0.41	100, 1000	30.5, 305
PVC-105-17	0.045	1.14	0.054	1.37	0.016	0.41	100, 1000	30.5, 305
PVC-105-16	0.051	1.30	0.061	1.55	0.016	0.41	100, 1000	30.5, 305
PVC-105-15	0.057	1.45	0.067	1.70	0.016	0.41	100, 1000	30.5, 305
PVC-105-14	0.064	1.63	0.072	1.83	0.016	0.41	100, 500	30.5, 152
PVC-105-13	0.072	1.83	0.08	2.03	0.016	0.41	100, 500	30.5, 152
PVC-105-12	0.081	2.06	0.089	2.26	0.016	0.41	500	152
PVC-105-11	0.091	2.31	0.101	2.57	0.016	0.41	100, 500	30.5, 152
PVC-105-10	0.102	2.59	0.112	2.84	0.016	0.41	500	152
PVC-105-9	0.114	2.90	0.124	3.15	0.020	0.51	500	152
PVC-105-8	0.129	3.28	0.141	3.58	0.020	0.51	100, 500	30.5, 152
PVC-105-7	0.144	3.66	0.158	4.01	0.020	0.51	100, 500	30.5, 152
PVC-105-6	0.162	4.11	0.178	4.52	0.020	0.51	100, 500	30.5, 152
PVC-105-5	0.183	4.65	0.198	5.03	0.020	0.51	100, 500	30.5, 152
PVC-105-4	0.204	5.18	0.224	5.69	0.020	0.51	100, 250	30.5, 76
PVC-105-3	0.229	5.82	0.249	6.32	0.020	0.51	100, 250	30.5, 76
PVC-105-2	0.258	6.55	0.278	7.06	0.020	0.51	250	76
PVC-105-1	0.289	7.34	0.311	7.90	0.020	0.51	100, 250	30.5, 76
PVC-105-5/16	0.313	7.95	0.334	8.48	0.025	0.64	100, 250	30.5, 76
PVC105-0	0.325	8.26	0.347	8.81	0.020	0.51	100, 250	30.5, 76
PVC-105-3/8	0.375	9.53	0.399	10.13	0.025	0.64	100, 250	30.5, 76
PVC-105-7/16	0.438	11.13	0.462	11.73	0.025	0.64	100	30.5
PVC-105-1/2A	0.500	12.70	0.524	13.31	0.025	0.64	100	30.5
PVC-105-9/16	0.562	14.27	0.592	15.04	0.030	0.76	100	30.5
PVC-105-5/8	0.625	15.88	0.655	16.64	0.030	0.76	100	30.5
PVC-105-3/4	0.750	19.05	0.786	19.96	0.035	0.89	50	15.2
PVC-105-7/8	0.875	22.23	0.911	23.14	0.035	0.89	50	15.2
PVC-105-1IN	1.000	25.40	1.036	26.31	0.035	0.89	50	15.2
PVC-105-1-1/8	1.125	28.58	1.161	29.49	0.010	0.25	50	15.2
PVC-105-1-1/4	1.250	31.75	1.29	32.77	0.040	1.02	50	15.2
PVC-105-1-1/2	1.500	38.10	1.55	39.37	0.045	1.14	50	15.2
PVC-105-2IN	2.000	50.80	2.07	52.58	0.060	1.52	50	15.2
PVC-105-2-1/2	2.500	63.50	2.53	64.26	0.070	1.78	50	15.2



FIT® Wire Management

Flexible Liquid-Tight PVC Tubing

FNT Tubing

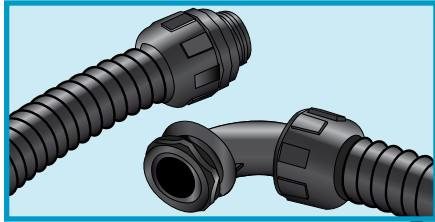

PVC Tubing

Part No.	Trade Size	Inside Diameter, Min.		Inside Diameter, Max.		Outside Diameter, Min.		Outside Diameter, Max.	
		Inch	mm	Inch	mm	Inch	mm	Inch	mm
FNT-1/4*	1/4	0.385	9.78	0.405	10.29	0.560	14.22	0.575	14.61
FNT-3/8	3/8	0.484	12.29	0.504	12.80	0.690	17.53	0.710	18.03
FNT-1/2	1/2	0.622	15.80	0.642	16.31	0.820	20.83	0.840	21.34
FNT-3/4	3/4	0.820	20.83	0.840	21.34	1.030	26.16	1.050	26.67
FNT-1	1	1.041	26.44	1.066	27.08	1.290	32.77	1.315	33.40

*Not CSA certified

UL 1696

CSA C22.2 No. 227.3-05

Operating Temperature

- -18°C to +50°C

Color

- Black

Materials

- Liquid-tight PVC tubing

Chemical Properties

- Corrosive effect: none
- Fungus resistance: no growth
- Resists oil and water
- Lead free

Availability

25 ft (7.5 m)

100 ft (30.5 m)



FIT® Wire Management

Liquid-Tight Nylon Connectors SLC or RLC

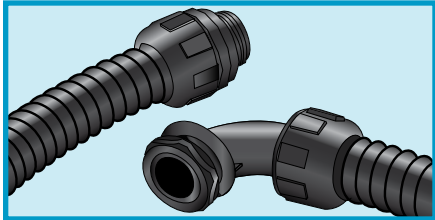

Part No.		Trade Size	Thread Size
Straight	90°		
SLC-1/4*	—	1/4	—
SLC-3/8	RLC-3/8	3/8	1/2 NPT
SLC-1/2	RLC-1/2	1/2	1/2 NPT
SLC-3/4	RLC-3/4	3/4	3/4 NPT
SLC-1	RLC-1	1	1 NPT

*Snap-on connector, not CSA certified

Operating Temperature

- +125°C

Color

- Black

Materials

- Nylon connector
- Supplied with o-ring and steel locking nut

Properties

- Resists salt water, weak acids, gasoline, alcohol, oil, grease, and common solvents
- Flammability rating: UL 94V-2

Availability

- 10-piece packages
- 100-piece packages



FIT® Wire Management

Convuluted Slit Loom Tubing

Type 492

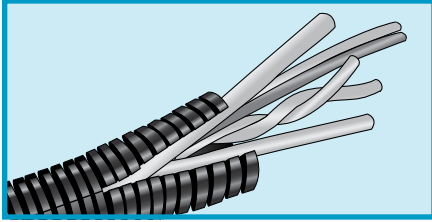

- Abrasion and fluid resistant
- Light weight
- Easy, flexible cable breakouts

Operating Temperature

- -40°C to +93°C

Color

- Black

Material

- Polyethylene

Chemical Properties

- Corrosive effect: none
- Fungus resistance: no growth
- Lead free

Electrical Properties

- Volume resistivity: 10¹⁵ ohm-cm

Availability

100 ft (30.5 m)

Part No.	Inside Diameter, Min.		Inside Diameter, Max.		Outside Diameter, Min.		Outside Diameter, Max.	
	Inch	mm	Inch	mm	Inch	mm	Inch	mm
492250	0.256	6.50	0.276	7.01	0.373	9.47	0.398	10.11
492350	0.341	8.66	0.38	9.65	0.496	12.60	0.526	13.36
492413	0.399	10.13	0.437	11.10	0.569	14.45	0.597	15.16
492500	0.473	12.01	0.516	13.11	0.664	16.87	0.70	17.78
492625	0.603	15.32	0.639	16.23	0.802	20.37	0.837	21.26
492750	0.707	17.96	0.759	19.28	0.95	24.13	0.989	25.12
492100	1.020	25.91	1.069	27.15	1.251	31.78	1.304	33.12
492150	1.566	39.78	1.647	41.83	1.867	47.42	1.947	49.45
492200	1.969	50.01	2.038	51.77	2.285	58.04	2.388	60.66

FIT® Wire Management

Loom Tee Connector Fittings

Type 493

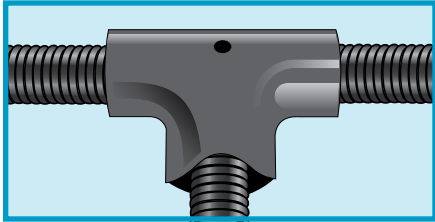

Part No.	Mating Loom Size					
	Left		Center		Right	
	Inch	mm	Inch	mm	Inch	mm
493100	0.413 or 0.500	10.49 or 12.70	0.413 or 0.500	10.49 or 12.70	0.413 or 0.500	10.49 or 12.70
493101	0.500	12.70	0.350	8.89	0.750	19.05
493102	0.500	12.70	0.413	10.49	0.750	19.05
493103	0.750	19.05	0.500	12.70	0.750	19.05
493110	0.413	10.49	0.350	8.89	0.350	8.89
493118	1.000	25.40	0.625	15.88	0.100	2.54

Operating Temperature

- -40°C to +90°C

Color

- Black

Material

- Polypropylene

Chemical Properties

- Corrosive effect: none
- Fungus resistance: no growth
- Lead free

Availability

Single pieces

FIT® Wire Management

Zipper Tubing™

ZIP-41

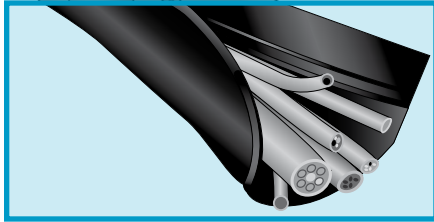

**MIL-I-631
UL 224 VW-1**

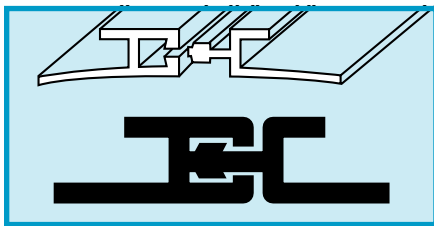

Loc-Trac® provides an effective closure that is ideal for use where the assembly will be subjected to random flexing.

Protection against flame, chemicals, and abrasion.

Operating Temperature

- -20°C to +105°C

Color

- Black

Material

- PVC

Physical Properties

- Tensile strength: 1800 psi (12.4 N/mm²)
- Elongation: 200% min.
- Flammability: UL VW-1

Chemical Properties

- Fungus resistance: no growth
- Lead free

Electrical Properties

- Dielectric strength: 700 V/mil (275.8 kV/cm)
- Volume resistivity: 10¹⁰ ohms/cm

Availability

25 ft (30.5 m)
100 ft (30.5 m)

Each spool comes with two Loc-Trac fasteners and installation instructions.

Part No.	Inside Diameter, Nom.		Wall Thickness, Nom.		Flat Width, Nom.	
	Inch	mm	Inch	mm	Inch	mm
ZIP-41-1/2	0.500	12.70	0.020	0.51	2.000	50.80
ZIP-41-5/8	0.625	15.88	0.020	0.51	2.375	60.33
ZIP-41-3/4	0.750	19.05	0.020	0.51	2.750	69.85
ZIP-41-7/8	0.875	22.23	0.020	0.51	3.125	79.38
ZIP-41-1IN	1.000	25.40	0.020	0.51	3.562	90.47
ZIP-41-1-1/4	1.250	31.75	0.020	0.51	4.125	104.78
ZIP-41-1-1/2	1.500	38.10	0.020	0.51	4.875	123.83
ZIP-41-1-3/4	1.750	44.45	0.020	0.51	5.625	142.88
ZIP-41-2IN	2.000	50.80	0.020	0.51	6.375	161.93
ZIP-41-2-1/4	2.250	57.15	0.020	0.51	7.500	190.50
ZIP-41-3IN	3.000	76.20	0.020	0.51	10.000	254.00

FIT® Wire Management

Spiral Wrap Tubing SW

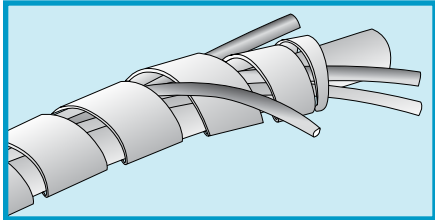

- Flexible cable bundling
- Easy breakouts

See table for specifications

	SW-1 to SW-6	SW-10 to SW-14	SW-20 to SW-25	SW-30 to SW-35	SW-40 to SW-45	SW-50 to SW-53
Material	Natural Polyethylene	Flame-Retardant Polyethylene	Nylon	PTFE	UV-Resistant Polyethylene	PVC
Colors	Natural	White	Natural	Natural, Black	Black	Black
Temperature Range (°C)	-66 to +88	-20 to +80	-40 to +121	-268 to +260	-66 to +88	-20 to +80
Abrasion Resistance (Taber)	22	27	6 - 8	7	20	Excellent
Flame Rating	Not rated	UL 1441 Self-extinguishing	Self-extinguishing	UL VW-1	Not rated	Self-extinguishing
Tensile Strength (psi (N/mm²))	1800 (12.41)	1300 (8.96)	12,000 (82.74)	3000 (20.68)	2000 (13.79)	3000 (20.68)
Water Absorption (%)	0.014	0.02	1.5	0.005	0.03	—
Dielectric Constant (Max.)	—	2.58	4.0	2.1	—	—
Effects of Alkalis and Acids	None	None	None	None	None	Satisfactory*
Weather Resistance	N/A	N/A	N/A	Excellent	N/A	N/A
Specs	UL UZKX2 MIL-I-631D, Type A, Form U MIL-P-21922B ASTM 1248-65T Type 1 Class A, Grade 3 A-A-59602, Type 1, Class 1	UL UZKX2 A-A-59602, Type 1, Class 3	UL UZKX2 ASTM-D-4066, Group 2, Class 1	UL UZKX2 ASTM-D-3295-01, Group 4 A-A-59602, Type 3, Class 1 (as noted)	UL UZKX2 MIL-I-631D, Type A, Form U MIL-P-21922B, Type 1 Class L A-A-59602, Type 1, Class 2	—

*Satisfactory except for high concentrations; not recommended for organic solvents.

FIT® Wire Management

Spiral Wrap Tubing

SW

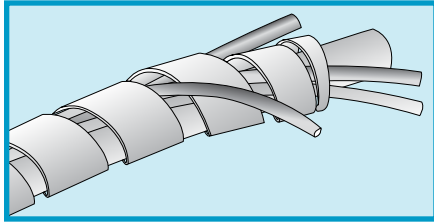

- Flexible cable bundling
- Easy breakouts

See table for specifications

Part No.	Material	Trade Size	Outside Diameter, Nom.		Wall Thickness, Nom.		Right-Hand Pitch, Nom.		Standard Put-Ups*	
			Inch	mm	Inch	mm	Inch	mm	Ft	m
SW-1	Natural PE	1/8	0.125	3.18	0.032	0.81	0.187	4.75	25, 100, 500	7.6, 30.5, 152
SW-2	Natural PE	1/4	0.250	6.35	0.045	1.14	0.375	9.53	25, 100, 500	7.6, 30.5, 152
SW-3	Natural PE	3/8	0.375	9.53	0.052	1.32	0.438	11.13	25, 100	7.6, 30.5
SW-4	Natural PE	1/2	0.500	12.70	0.062	1.57	0.563	14.30	25, 100	7.6, 30.5
SW-5	Natural PE	3/4	0.750	19.05	0.065	1.65	0.750	19.05	25, 100, 500	7.6, 30.5, 152
SW-6	Natural PE	1	1.000	25.40	0.080	2.03	1.000	25.40	25, 100, 500	7.6, 30.5, 152
SW-10	FR PE	1/8	0.125	3.18	0.032	0.81	0.187	4.75	25, 100, 500	7.6, 30.5, 152
SW-11	FR PE	1/4	0.250	6.35	0.045	1.14	0.375	9.53	25, 100, 500	7.6, 30.5, 152
SW-12	FR PE	3/8	0.375	9.53	0.052	1.32	0.438	11.13	25, 100	7.6, 30.5
SW-13	FR PE	1/2	0.500	12.70	0.062	1.57	0.563	14.30	25, 100	7.6, 30.5
SW-14	FR PE	3/4	0.750	19.05	0.065	1.65	0.750	19.05	25, 100	7.6, 30.5
SW-20	Nylon	1/8	0.125	3.18	0.015	0.38	0.187	4.75	25, 100, 500	7.6, 30.5, 152
SW-21	Nylon	1/4	0.250	6.35	0.025	0.64	0.375	9.53	25, 100, 500	7.6, 30.5, 152
SW-22	Nylon	3/8	0.375	9.53	0.035	0.89	0.438	11.13	25, 100	7.6, 30.5
SW-23	Nylon	1/2	0.500	12.70	0.035	0.89	0.500	12.70	25, 100	7.6, 30.5
SW-24	Nylon	3/4	0.750	19.05	0.032	0.81	0.750	19.05	25, 100, 500	7.6, 30.5, 152
SW-25	Nylon	1	1.000	25.40	0.032	0.81	1.000	25.40	25, 100	7.6, 30.5
SW-30	PTFE	1/8	0.125	3.18	0.030	0.76	0.187	4.75	25, 100	7.6, 30.5
SW-31	PTFE	1/4	0.250	6.35	0.030	0.76	0.375	9.53	25, 100	7.6, 30.5
SW-32**	PTFE	3/8	0.375	9.53	0.030	0.76	0.438	11.13	25, 100	7.6, 30.5
SW-33**	PTFE	1/2	0.500	12.70	0.030	0.76	0.500	12.70	25, 100	7.6, 30.5
SW-34**	PTFE	3/4	0.750	19.05	0.032	0.81	0.750	19.05	25, 100	7.6, 30.5
SW-35	PTFE	1	1.000	25.40	0.040	1.02	1.000	25.40	25, 100	7.6, 30.5
SW-40	UV-Res. PE	1/8	0.125	3.18	0.032	0.81	0.187	4.75	25, 100, 500	7.6, 30.5, 152
SW-41	UV-Res. PE	1/4	0.250	6.35	0.045	1.14	0.375	9.53	25, 100, 500	7.6, 30.5, 152
SW-42	UV-Res. PE	3/8	0.375	9.53	0.052	1.32	0.438	11.13	25, 100	7.6, 30.5
SW-43	UV-Res. PE	1/2	0.500	12.70	0.062	1.57	0.500	12.70	25, 100	7.6, 30.5
SW-44	UV-Res. PE	3/4	0.750	19.05	0.065	1.65	0.750	19.05	25, 100, 500	7.6, 30.5, 152
SW-45	UV-Res. PE	1	1.000	25.40	0.080	2.03	1.000	25.40	25, 100, 500	7.6, 30.5, 152
SW-50	PVC	1/8	0.125	3.18	0.032	0.81	0.187	4.75	25, 100	7.6, 30.5
SW-51	PVC	1/4	0.250	6.35	0.045	1.14	0.375	9.53	25, 100	7.6, 30.5
SW-52	PVC	3/8	0.375	9.53	0.052	1.32	0.438	11.13	25, 100	7.6, 30.5
SW-53	PVC	1/2	0.500	12.70	0.062	1.57	0.500	12.70	25, 100	7.6, 30.5

*May contain multiple lengths.

**Does not meet A-A-59602 Type 3 Class 1



FIT® Wire Management

Flexible PTFE Thin-Wall Tubing

TFT-200

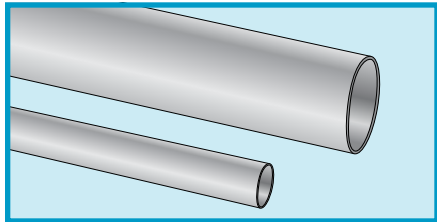

**ASTM D 3295-81a Type I
Class B
AMS 3655**

- Flexible wire protection for harnesses and ground straps
- Resistance to heat, oil, and abrasion

Operating Temperature

- -75°C to +260°C

Color

- Natural

Material

- PTFE

Physical Properties

- Tensile strength: 2000 psi (13.7 N/mm²)
- Elongation: 200% min.
- Specific gravity: 2.18
- Flammability rating: UL 94V-0

Chemical Properties

- Corrosive effect: none
- Fungus resistance: no growth
- Water absorption: 0.01%
- Lead free

Electrical Properties

- Dielectric strength: 1400 V/mil (55 kV/cm)
- Volume resistivity: 10¹⁸ ohm-cm
- Dielectric constant: 2.1

Availability

See table

Spools may contain multiple lengths

TFT-200-7 and larger supplied as coils

Part No.	Inside Diameter, Min.		Inside Diameter, Max.		Wall Thickness, Min.		Standard Put-Ups	
	Inch	mm	Inch	mm	Inch	mm	Ft	m
TFT-200-30	0.010	0.25	0.015	0.38	0.009	0.23	100, 500, 1000	30.5, 152, 305
TFT-200-28	0.013	0.33	0.018	0.46	0.009	0.23	100, 500, 1000	30.5, 152, 305
TFT-200-26	0.016	0.41	0.021	0.53	0.009	0.23	100, 500, 1000	30.5, 152, 305
TFT-200-24	0.020	0.51	0.026	0.66	0.010	0.25	100, 500, 1000	30.5, 152, 305
TFT-200-22	0.026	0.66	0.032	0.81	0.010	0.25	100, 500, 1000	30.5, 152, 305
TFT-200-20	0.032	0.81	0.04	1.02	0.012	0.30	100, 500, 1000	30.5, 152, 305
TFT-200-19	0.036	0.91	0.042	1.07	0.012	0.30	100, 1000	30.5, 305
TFT-200-18	0.040	1.02	0.046	1.17	0.012	0.30	100, 500, 1000	30.5, 152, 305
TFT-200-17	0.045	1.14	0.052	1.32	0.012	0.30	100, 500, 1000	30.5, 152, 305
TFT-200-16	0.051	1.30	0.058	1.47	0.012	0.30	100, 1000	30.5, 305
TFT-200-15	0.057	1.45	0.065	1.65	0.012	0.30	100, 1000	30.5, 305
TFT-200-14	0.064	1.63	0.072	1.83	0.012	0.30	100, 500	30.5, 152
TFT-200-13	0.072	1.83	0.081	2.06	0.012	0.30	100, 500	30.5, 152
TFT-200-12	0.081	2.06	0.091	2.31	0.012	0.30	100, 500	30.5, 152
TFT-200-11	0.091	2.31	0.101	2.57	0.012	0.30	100, 500	30.5, 152
TFT-200-10	0.102	2.59	0.112	2.84	0.012	0.30	100, 500	30.5, 152
TFT-200-9	0.114	2.90	0.124	3.15	0.012	0.30	100, 500	30.5, 152
TFT-200-8	0.129	3.28	0.139	3.53	0.015	0.38	100	30.5
TFT-200-7	0.144	3.66	0.155	3.94	0.015	0.38	100	30.5
TFT-200-6	0.162	4.11	0.174	4.42	0.015	0.38	100*	30.5*
TFT-200-5	0.182	4.62	0.195	4.95	0.015	0.38	100*	30.5*
TFT-200-4	0.204	5.18	0.218	5.54	0.015	0.38	100*	30.5*
TFT-200-3	0.229	5.82	0.244	6.20	0.015	0.38	100*	30.5*
TFT-200-2	0.258	6.55	0.273	6.93	0.015	0.38	100*	30.5*
TFT-200-1	0.289	7.34	0.305	7.75	0.015	0.38	100*	30.5*
TFT-200-0	0.325	8.26	0.342	8.69	0.015	0.38	100*	30.5*

*Supplied as coils.



FIT® Wire Management

Flexible PTFE Standard-Wall Tubing TFT-250

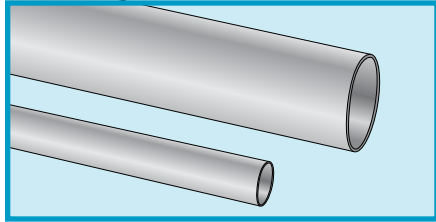

ASTM D 3295-81a Type I Class C MIL-I-22129

- Excellent heat and chemical resistance
- Flexible wire protection for harnesses and ground straps
- Resistance to heat, oil, and abrasion

Operating Temperature

- -75°C to +260°C

Color

- Natural

Material

- PTFE

Physical Properties

- Tensile strength: 2000 psi (13.7 N/mm²)
- Elongation: 200% min.
- Specific gravity: 2.18
- Flammability rating: UL 94V-0

Chemical Properties

- Corrosive effect: none
- Fungus resistance: no growth
- Water absorption: 0.01%
- Lead free

Electrical Properties

- Dielectric strength: 1400 V/mil (551 kV/cm)
- Volume resistivity: 10¹⁸ ohm-cm
- Dielectric constant: 2.1

Availability

See table

Spools may contain multiple lengths

TFT-200-7 and larger supplied as coils

Part No.	Inside Diameter, Min.		Inside Diameter, Max.		Wall Thickness, Min.		Standard Put-Ups	
	Inch	mm	Inch	mm	Inch	mm	Ft	m
TFT-250-24	0.020	0.51	0.026	0.66	0.012	0.30	100, 500, 1000	30.5, 152, 305
TFT-250-22	0.025	0.64	0.032	0.81	0.012	0.30	100, 500, 1000	30.5, 152, 305
TFT-250-20	0.032	0.81	0.040	1.02	0.016	0.41	100, 500, 1000	30.5, 152, 305
TFT-250-19	0.036	0.91	0.044	1.12	0.016	0.41	100, 500, 1000	30.5, 152, 305
TFT-250-18	0.040	1.02	0.049	1.24	0.016	0.41	100, 500, 1000	30.5, 152, 305
TFT-250-17	0.045	1.14	0.054	1.37	0.016	0.41	100, 1000	30.5, 305
TFT-250-16	0.051	1.30	0.061	1.55	0.016	0.41	100, 500, 1000	30.5, 152, 305
TFT-250-15	0.057	1.45	0.067	1.70	0.016	0.41	100, 500	30.5, 152
TFT-250-14	0.064	1.63	0.074	1.88	0.016	0.41	100, 500	30.5, 152
TFT-250-13	0.072	1.83	0.082	2.08	0.016	0.41	100	30.5
TFT-250-12	0.081	2.06	0.091	2.31	0.016	0.41	100	30.5
TFT-250-11	0.091	2.31	0.101	2.57	0.016	0.41	100, 500	30.5, 152
TFT-250-10	0.102	2.59	0.112	2.84	0.016	0.41	100, 500	30.5, 152
TFT-250-9	0.114	2.90	0.124	3.15	0.020	0.51	100, 500	30.5, 152
TFT-250-8	0.129	3.28	0.141	3.58	0.020	0.51	100	30.5
TFT-250-7	0.144	3.66	0.158	4.01	0.020	0.51	100	30.5
TFT-250-6	0.162	4.11	0.178	4.52	0.020	0.51	100*	30.5*
TFT-250-5	0.182	4.62	0.196	4.98	0.020	0.51	100*	30.5*
TFT-250-4	0.204	5.18	0.224	5.69	0.020	0.51	100*	30.5*
TFT-250-3	0.229	5.82	0.249	6.32	0.020	0.51	100*	30.5*
TFT-250-2	0.258	6.55	0.278	7.06	0.020	0.51	100*	30.5*
TFT-250-1	0.289	7.34	0.311	7.90	0.020	0.51	100*	30.5*
TFT-250-0	0.325	8.26	0.342	8.69	0.020	0.51	100*	30.5*

*Supplied as coils.



FIT® Wire Management

Acrylic-Coated Fiberglass Sleeving

AF-155

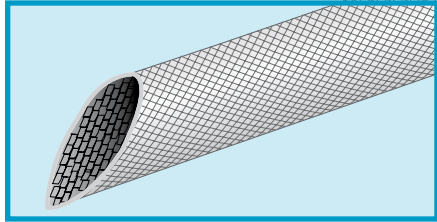

**MIL-I-3190/3 Grade C1
NEMA TF-1**

Operating Temperature

- -30°C to +155°C

Color

- Natural

Material

- Acrylic-coated fiberglass braid

Physical Properties

- Elongation: 150% min.
- Low-temperature (-10°C) flexing: no cracking

Chemical Properties

- Corrosive effect: none
- Fungus resistance: no growth
- Lead free

Electrical Properties

- Dielectric strength: 2500 V/mil (984 kV/cm)
- Dielectric constant: 2.5
- Volume resistivity: 10¹⁰ ohm-cm

Availability

See table

Spools may contain multiple lengths

Part No.	Inside Diameter, Min.		Inside Diameter, Max.		Wall Thickness, Min.		Standard Put-Ups	
	Inch	mm	Inch	mm	Inch	mm	Ft	m
AF-155-24	0.020	0.51	0.027	0.69	0.006	0.15	100, 500	30.5, 152
AF-155-22	0.025	0.64	0.032	0.81	0.006	0.15	100, 500	30.5, 152
AF-155-20	0.032	0.81	0.039	0.99	0.006	0.15	100, 500	30.5, 152
AF-155-18	0.040	1.02	0.049	1.24	0.006	0.15	100, 500	30.5, 152
AF-155-16	0.051	1.30	0.061	1.55	0.006	0.15	100, 500	30.5, 152
AF-155-15	0.057	1.45	0.067	1.70	0.006	0.15	100, 500	30.5, 152
AF-155-14	0.064	1.63	0.074	1.88	0.006	0.15	100, 500	30.5, 152
AF-155-13	0.072	1.83	0.082	2.08	0.006	0.15	100, 250	30.5, 76
AF-155-12	0.081	2.06	0.091	2.31	0.006	0.15	100, 250	30.5, 76
AF-155-11	0.091	2.31	0.101	2.57	0.008	0.20	100, 250	30.5, 76
AF-155-10	0.102	2.59	0.112	2.84	0.008	0.20	100, 250	30.5, 76
AF-155-9	0.114	2.90	0.124	3.15	0.008	0.20	100, 250	30.5, 76
AF-155-8	0.129	3.28	0.141	3.58	0.008	0.20	100, 250	30.5, 76
AF-155-7	0.144	3.66	0.158	4.01	0.008	0.20	100, 250	30.5, 76
AF-155-6	0.162	4.11	0.178	4.52	0.010	0.25	100, 250	30.5, 76
AF-155-5	0.182	4.62	0.198	5.03	0.010	0.25	100, 250	30.5, 76
AF-155-4	0.204	5.18	0.224	5.69	0.010	0.25	100, 250	30.5, 76
AF-155-3	0.229	5.82	0.249	6.32	0.010	0.25	100, 250	30.5, 76
AF-155-2	0.258	6.55	0.278	7.06	0.010	0.25	100, 250	30.5, 76
AF-155-1	0.289	7.34	0.311	7.90	0.010	0.25	100, 125	30.5, 38
AF-155-0	0.325	8.26	0.347	8.81	0.016	0.41	100, 125	30.5, 38
AF-155-3/8	0.375	9.53	0.399	10.13	0.016	0.41	125, 250	38, 76
AF-155-7/16	0.438	11.13	0.462	11.73	0.016	0.41	125	38
AF-155-1/2	0.500	12.70	0.524	13.31	0.016	0.41	100	30.5
AF-155-5/8	0.625	15.88	0.655	16.64	0.016	0.41	100	30.5
AF-155-3/4	0.750	19.05	0.786	19.96	0.016	0.41	100	30.5
AF-155-7/8	0.875	22.23	0.911	23.14	0.016	0.41	100	30.5
AF-155-1IN	1.000	25.40	1.036	26.31	0.016	0.41	100	30.5



FIT® Wire Management

PVC-Coated Fiberglass Sleeving

PIF-130

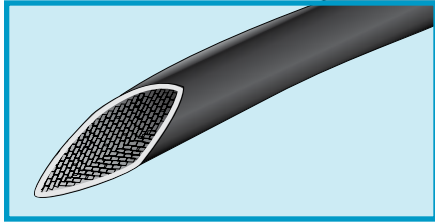

UL 1441 (600 V_{RMS})
UL VW-1
MIL-I-3190/2 Class 130
Type B Category b
NEMA TF-1 Grade A

- High temperature, abrasion, and oil resistance
- Resists fraying, bending, and knotting

Operating Temperature

- -20°C to +130°C

Color

- Black

Material

- PVC-coated fiberglass braid

Chemical Properties

- Corrosive effect: non-corrosive
- Fungus resistance: no growth
- Lead free

Electrical Properties

- Dielectric strength: 5000 V/mil (1968 kV/cm)
- Volume resistivity: 10⁹ ohm-cm

Availability

See tables

Spools may contain multiple lengths

Standard Wall Thickness

Part No.	Inside Diameter, Min.		Inside Diameter, Max.		Wall Thickness, Min.		Standard Put-Ups	
	Inch	mm	Inch	mm	Inch	mm	Ft	m
PIF-130-20	0.032	0.81	0.039	0.99	0.013	0.33	100, 500, 1000	30.5, 152, 305
PIF-130-18	0.040	1.02	0.049	1.24	0.015	0.38	100, 500, 1000	30.5, 152, 305
PIF-130-16	0.051	1.30	0.061	1.55	0.015	0.38	100, 1000	30.5, 305
PIF-130-14	0.064	1.63	0.074	1.88	0.015	0.38	100	30.5
PIF-130-12	0.081	2.06	0.091	2.31	0.015	0.38	100, 500	30.5, 152
PIF-130-10	0.102	2.59	0.112	2.84	0.018	0.46	100, 500	30.5, 152
PIF-130-8	0.129	3.28	0.141	3.58	0.018	0.46	100, 500	30.5, 152
PIF-130-6	0.162	4.11	0.178	4.52	0.020	0.51	100, 250	30.5, 76
PIF-130-4	0.204	5.18	0.224	5.69	0.020	0.51	100, 250	30.5, 76
PIF-130-2	0.258	6.55	0.278	7.06	0.020	0.51	100, 250	30.5, 76
PIF-130-0	0.325	8.26	0.347	8.81	0.025	0.64	100	30.5
PIF-130-3/8	0.375	9.53	0.399	10.13	0.025	0.64	100	30.5
PIF-130-7/16	0.438	11.13	0.462	11.73	0.025	0.64	100	30.5
PIF-130-1/2A	0.500	12.70	0.524	13.31	0.025	0.64	100	30.5
PIF-130-5/8	0.625	15.88	0.655	16.64	0.025	0.64	100	30.5
PIF-130-3/4	0.750	19.05	0.786	19.96	0.025	0.64	100	30.5
PIF-130-7/8	0.875	22.23	0.911	23.14	0.025	0.64	100	30.5
PIF-130-1IN	1.000	25.40	1.036	26.31	0.025	0.64	100	30.5



FIT® Wire Management

Silicone-Coated Fiberglass Sleeving

PIF-200, SF-200

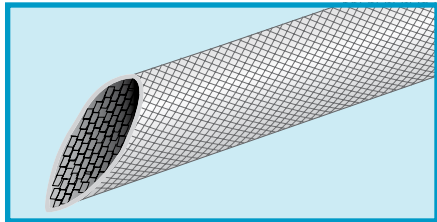

**UL 1441 (600 V_{RMS})
MIL-I-3190/6 Class 20 Type D
Category C
NEMA TF-1 Grade A**

- Highly flexible routing
- Extreme abrasion resistance
- Superior electrical properties

Operating Temperature

- -70°C to +200°C

Color

- Natural

Material

- Silicone rubber-coated fiberglass braid

Physical Properties

- Tensile strength: 1200 psi (8.2 N/mm²)
- Elongation: 420% min.

Chemical Properties

- Corrosive effect: none
- Fungus resistance: no growth
- Lead free

Electrical Properties

- Dielectric strength: 15,000 V/mil (5905 kV/cm)
- Volume resistivity: 6 x 10¹³ ohm-cm
- Dielectric constant: 2.8

Availability

See table

Spools may contain multiple lengths

Part No.	Inside Diameter, Min.		Inside Diameter, Max.		Wall Thickness, Min.		Standard Put-Ups	
	Inch	mm	Inch	mm	Inch	mm	Ft	m
PIF-200-24	0.020	0.51	0.027	0.69	0.011	0.28	100, 500, 1000	30.5, 152, 305
PIF-200-22	0.025	0.64	0.032	0.81	0.013	0.33	100, 500, 1000	30.5, 152, 305
PIF-200-20	0.032	0.81	0.039	0.99	0.013	0.33	100, 500, 1000	30.5, 152, 305
PIF-200-18	0.040	1.02	0.049	1.24	0.015	0.38	100, 500, 1000	30.5, 152, 305
PIF-200-17	0.045	1.14	0.054	1.37	0.015	0.38	500, 1000	152, 305
PIF-200-16	0.051	1.30	0.061	1.55	0.015	0.38	100, 500, 1000	30.5, 152, 305
PIF-200-15	0.057	1.45	0.067	1.70	0.015	0.38	100, 1000	30.5, 305
PIF-200-14	0.064	1.63	0.074	1.88	0.015	0.38	100, 500	30.5, 152
PIF-200-13	0.072	1.83	0.082	2.08	0.015	0.38	100, 500	30.5, 152
PIF-200-12	0.081	2.06	0.091	2.31	0.015	0.38	100, 500	30.5, 152
PIF-200-11	0.091	2.31	0.101	2.57	0.018	0.46	500	152
PIF-200-10	0.102	2.59	0.112	2.84	0.018	0.46	100, 500	30.5, 152
PIF-200-9	0.114	2.90	0.124	3.15	0.018	0.46	100, 500	30.5, 152
PIF-200-8	0.129	3.28	0.141	3.58	0.018	0.46	100, 500	30.5, 152
PIF-200-7	0.144	3.66	0.158	4.01	0.018	0.46	100, 500	30.5, 152
PIF-200-6	0.162	4.11	0.178	4.52	0.020	0.51	25, 100	7.6, 30.5
PIF-200-5	0.182	4.62	0.198	5.03	0.020	0.51	25, 100	7.6, 30.5
PIF-200-4	0.204	5.18	0.224	5.69	0.020	0.51	100	30.5
PIF-200-3	0.229	5.82	0.249	6.32	0.020	0.51	25, 100	7.6, 30.5
PIF-200-2	0.258	6.55	0.278	7.06	0.020	0.51	25, 100	7.6, 30.5
PIF-200-1	0.289	7.34	0.311	7.90	0.020	0.51	100	30.5
PIF-200-0	0.313	7.95	0.347	8.81	0.020	0.51	100	30.5
PIF-200-3/8	0.375	9.53	0.398	10.11	0.025	0.64	25, 100	7.6, 30.5
PIF-200-7/16	0.438	11.13	0.462	11.73	0.025	0.64	25, 100	7.6, 30.5
PIF-200-1/2A	0.500	12.70	0.524	13.31	0.025	0.64	25, 100	7.6, 30.5
PIF-200-5/8	0.625	15.88	0.655	16.64	0.025	0.64	25, 100	7.6, 30.5
SF-200-3/4	0.750	19.05	0.786	19.96	0.025	0.64	100	30.5
SF-200-7/8	0.875	22.23	0.911	23.14	0.025	0.64	100	30.5
SF-200-1IN	1.000	25.40	1.036	26.31	0.025	0.64	100	30.5



FIT® Wire Management

Uncoated Fiberglass Sleeving

PIF-240

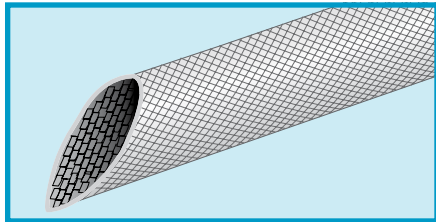

UL 1441 (500 V_{RMS})
UL VW-1
MIL-Y-1140
ASTM D 350/372 Class C

- Extreme flexibility
- Extreme heat environments

Operating Temperature

- -60°C to +648°C

Color

- Natural

Material

- Heat-annealed braided fiberglass

Chemical Properties

- Corrosive effect: none
- Fungus resistance: no growth
- Lead free

Electrical Properties

- Volume resistivity: 10¹⁵ ohm-cm

Availability

100 ft (30.5 m)

Spools may contain multiple lengths

Part No.	Inside Diameter, Min.		Inside Diameter, Max.		Wall Thickness, Min.	
	Inch	mm	Inch	mm	Inch	mm
PIF-240-20	0.032	0.81	0.039	0.99	0.009	0.23
PIF-240-18	0.040	1.02	0.049	1.24	0.011	0.28
PIF-240-16	0.051	1.30	0.061	1.55	0.011	0.28
PIF-240-15	0.057	1.45	0.067	1.70	0.011	0.28
PIF-240-14	0.064	1.63	0.074	1.88	0.011	0.28
PIF-240-12	0.081	2.06	0.091	2.31	0.011	0.28
PIF-240-11	0.091	2.31	0.101	2.57	0.011	0.28
PIF-240-10	0.102	2.59	0.112	2.84	0.011	0.28
PIF-240-9	0.114	2.90	0.124	3.15	0.011	0.28
PIF-240-8	0.129	3.28	0.141	3.58	0.011	0.28
PIF-240-7	0.144	3.66	0.158	4.01	0.013	0.33
PIF-240-6	0.162	4.11	0.178	4.52	0.013	0.33
PIF-240-5	0.182	4.62	0.198	5.03	0.013	0.33
PIF-240-4	0.204	5.18	0.224	5.69	0.016	0.41
PIF-240-3	0.229	5.82	0.249	6.32	0.016	0.41
PIF-240-2	0.258	6.55	0.278	7.06	0.016	0.41
PIF-240-1	0.289	7.34	0.311	7.90	0.016	0.41
PIF-240-0	0.325	8.26	0.347	8.81	0.016	0.41
PIF-240-3/8	0.375	9.53	0.399	10.13	0.016	0.41
PIF-240-7/16	0.438	11.13	0.462	11.73	0.018	0.46
PIF-240-1/2A	0.500	12.70	0.524	13.31	0.018	0.46
PIF-240-5/8	0.625	15.88	0.655	16.64	0.018	0.46
PIF-240-3/4	0.750	19.05	0.783	19.89	0.018	0.46
PIF-240-7/8	0.875	22.23	0.991	25.17	0.018	0.46
PIF-240-1IN	1.000	25.40	1.026	26.06	0.018	0.46



FIT® Wire Management

Copper EMI Shielding Tape CST Series

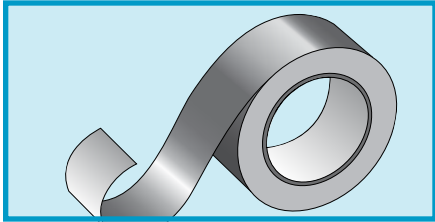

UL 510 ASTM D 1000, Method 303 MIL-STD-202C

- EMI shielding
- Highly conductive pressure-sensitive adhesive seal

Operating Temperature

- -40°C to +205°C

Color

- Copper

Material

- Copper foil on pressure-sensitive adhesive

Physical Properties

- Tensile strength: 21 lb/inch (0.145 N/mm²)
- Adhesion: 40 oz/inch
- Foil thickness: 0.0014 inch (0.04 mm)
- Adhesive thickness: 0.00015 inch (0.004 mm)
- Flammability: flame resistant per UL 510

Electrical Properties

- Electrical resistance through tape: <0.003 ohms/inch² (<0.0005 ohms/cm²)
- Shielding effectiveness: 50 dB at 153 MHz

Availability

36-yard (33 m) rolls

Part No.	Width	
	Inch	mm
CST-5	0.50	12.70
CST-10	1.00	25.40
CST-15	1.50	38.10
CST-20	2.00	50.80

FIT® Wire Management

Self-Fusing Silicone Tape

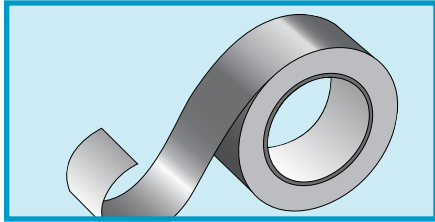

A-A-59163

- Cures within 48 hours at room temperature or 4 hours at 177°C
- No adhesive required
- Low-cost seal for electrical insulation, cables harnesses, splices, hot air ducting, and electrical wire wrap
- Conforms to irregular shapes to protect, secure, insulate, mask
- Resists outside weathering

Operating Temperature

- -90°C to +260°C (continuous)

Colors

- Red, black, blue, yellow, white, green

Material

- Silicone

Physical Properties

- Tensile strength: 700 psi (4.8 N/mm²) min.
- Elongation: 300% min.
- Water absorption: 3% max.
- Bond strength: 20 lbf (25 kgf)
- Shelf life: 1 year at 37.3°C for unopened container

Electrical Properties

- Dielectric strength: 400 V/mil (157 kV/cm)
- Volume resistivity: 1 x 10¹³ ohm-cm

Availability

- 14-ft put-ups (all colors)
- 35-ft put-ups (black, red)

Part No.	Width		Thickness	
	Inch	mm	Inch	mm
TY2001	1.000	25.40	0.020	0.51

FIT® Wire Management

Expandable Braided Sleeving

GRP-110, GRP-120

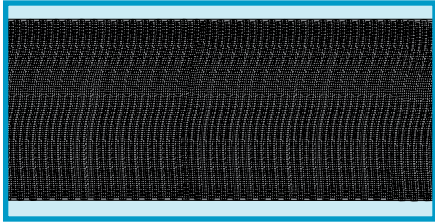

UL UZKX2
UL VW-1 (GRP-120)
MIL-I-631

- Light weight, flexible routing
- High abrasion and cut-through resistance

Operating Temperature

- -75°C to +125°C
- 250°C melt temperature

Color

- GRP-110: Black or natural
- GRP-120: Black with white tracer thread or white with black tracer thread

Material

- Braided polyester
- Should be cut with hot knife

Physical Properties

- Tensile strength:
 GRP-110: 85,000 psi (586 N/mm²)
 GRP-120: 55,000 psi (379 N/mm²)

Chemical Properties

- Corrosive effect: noncorrosive
- Fungus resistance: no growth
- GRP-120: flame retardant
- Halogen free
- Lead free

Availability

See tables

Spools may contain multiple lengths

General-Purpose Sleeving

Part No.	Inside Diameter, Min.		Expanded Inside Diameter, Max.		Wall Thickness		Construction			Standard Put-Ups	
	Inch	mm	Inch	mm	Inch	mm	Carriers	Yarns	Total	Ft	m
GRP-110-1/8	0.093	2.36	0.250	6.35	0.025	0.64	32	1	32	100, 500	30.5, 152
GRP-110-1/4	0.125	3.18	0.375	9.53	0.025	0.64	24	3	72	100, 500	30.5, 152
GRP-110-1/2	0.250	6.35	0.750	19.05	0.025	0.64	48	3	144	100, 500	30.5, 152
GRP-110-3/4	0.500	12.70	1.250	31.75	0.025	0.64	72	3	216	100, 500	30.5, 152
GRP-110-1-1/4	0.750	19.05	1.750	44.45	0.025	0.64	96	3	288	50, 250	15.2, 76
GRP-110-1-3/4	1.250	31.75	2.750	69.85	0.025	0.64	120	4	480	50, 250	15.2, 76
GRP-110-2IN	1.500	38.10	3.500	88.90	0.025	0.64	120	4	480	50, 250	15.2, 76

Flame-Retardant Sleeving

Part No.	Inside Diameter, Min.		Expanded Inside Diameter, Max.		Wall Thickness		Construction			Standard Put-Ups	
	Inch	mm	Inch	mm	Inch	mm	Carriers	Yarns	Total	Ft	m
GRP-120-1/8	0.093	2.36	0.250	6.35	0.025	0.64	32	1	32	100, 500	30.5, 152
GRP-120-1/4	0.125	3.18	0.375	9.53	0.025	0.64	24	3	72	100, 500	30.5, 152
GRP-120-1/2	0.250	6.35	0.750	19.05	0.025	0.64	48	3	144	100, 500	30.5, 152
GRP-120-3/4	0.500	12.70	1.250	31.75	0.025	0.64	72	3	216	100, 500	30.5, 152
GRP-120-1-1/4	0.750	19.05	1.750	44.45	0.025	0.64	96	3	288	50, 250	15.2, 76
GRP-120-1-3/4	1.250	31.75	2.750	69.85	0.025	0.64	120	4	480	50, 250	15.2, 76
GRP-120-2IN	1.500	38.10	3.500	88.90	0.025	0.64	120	4	480	50, 250	15.2, 76



FIT® Wire Management

Non-Fraying, Expandable Braided Sleeving GRP-110NF, GRP-120NF

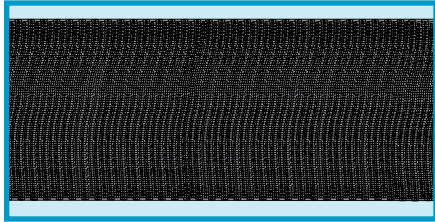

- Light weight, flexible routing
- Frayless: cuts without a hot knife
- Compatible with automatic cutting machines

Operating Temperature

- -75°C to +125°C

Color

- GRP-110NF, XS-100: Black or natural
- GRP-120NF: Black with white tracer thread
- XS-100FR: Black or white

Material

- Braided PET

Physical Properties

- Tensile strength:
GRP-110NF: 85,000 psi (586 N/mm²)
GRP-120NF: 55,000 psi (379 N/mm²)
XS-100/100FR: 100,000 psi (689 N/mm²)

Chemical Properties

- Corrosive effect: none
- Fungus resistance: no growth

Availability

See tables

Spools may contain multiple lengths

UL UZKX2
UL VW-1 (GRP-120NF,
XS-100FR)
CSA 5836 01
MIL-I-631

General-Purpose Sleeving

Part No.	Inside Diameter, Min.		Expanded Inside Diameter, Max.		Wall Thickness		Construction			Standard Put-Ups	
	Inch	mm	Inch	mm	Inch	mm	Carriers	Yarns	Total	Ft	m
GRP-110NF18	0.125	3.18	0.250	6.35	0.024	0.61	32	3	96	100, 500	30.5, 152
GRP-110NF14	0.156	3.96	0.438	11.13	0.024	0.61	40	3	120	100, 500	30.5, 152
GRP-110NF12	0.250	6.35	0.750	19.05	0.024	0.61	64	3	192	100, 500	30.5, 152
GRP-110NF34	0.625	15.88	1.000	25.40	0.024	0.61	80	3	240	100, 500	30.5, 152
GRP-110NF114	1.000	25.40	1.500	38.10	0.024	0.61	120	3	360	50, 250	15.2, 76
GRP-110NF112	1.250	31.75	2.000	50.80	0.024	0.61	120	4	480	50, 250	15.2, 76
XS-100-2-1/2	2.000	50.80	3.500	88.90	0.025	0.64	144	5	720	100	30.5

Flame-Retardant Sleeving

Part No.	Inside Diameter, Min.		Expanded Inside Diameter, Max.		Wall Thickness		Construction			Standard Put-Ups	
	Inch	mm	Inch	mm	Inch	mm	Carriers	Yarns	Total	Ft	m
GRP-120NF18	0.125	3.18	0.250	6.35	0.024	0.61	32	3	96	100, 500	30.5, 152
GRP-120NF14	0.156	3.96	0.438	11.13	0.024	0.61	40	3	120	100, 500	30.5, 152
GRP-120NF12	0.250	6.35	0.750	19.05	0.024	0.61	64	3	192	100, 500	30.5, 152
GRP-120NF34	0.625	15.88	1.000	25.40	0.024	0.61	80	3	240	100, 500	30.5, 152
GRP-120NF114	1.000	25.40	1.500	38.10	0.024	0.61	120	3	360	50, 250	15.2, 76
GRP-120NF112	1.250	31.75	2.000	50.80	0.024	0.61	120	4	480	50, 250	15.2, 76
XS-100FR-2-1/2	2.000	50.80	3.500	88.90	0.025	0.64	144	5	720	100	30.5



FIT® Wire Management

Flexible, Semirigid Wrappable Sleeving GRP-130 and GRP-130NF

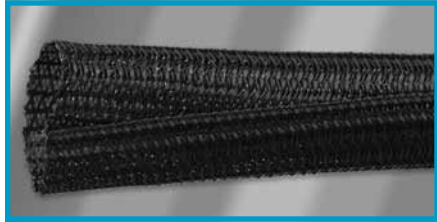

The choice for a wide variety of bundling applications without the need for additional fasteners

- UL UZKX2
- UL 94V-0 (GRP-130)
- UL VW1 (GRP-130NF)
- CSA 5836 01 FT2
- FAR 25 (GRP-130NR)

- Bends tightly without distorting or opening
- 25% edge overlap to accommodate connectors and splices
- Fast, easy wrap-around installation
- More flexible than spiral wrap or split convoluted tubing

Operating Temperature

- -70°C to +125°C
- GRP-130: 230°C melt temperature
- GRP-130NF: 250°C melt temperature

Color

- GRP-130: Black or orange
- GRP-130NF: Black with white tracer

Materials

- 10-mil PET braid
- Cuts with hot knife

Physical Properties

- Tensile strength:
GRP-130: 6 psi (0.04 N/mm²)
GRP-130NF: 4 psi (0.02 N/mm²)
- Specific gravity: 1.38 max

Chemical Properties

- Corrosive effects: noncorrosive
- Fungus resistance: no growth
- Water absorption: 0.10% max
- UV resistant
- Halogen free
- Lead free

Availability

See table
Reels may contain multiple lengths

The GRP-130 installation tool makes installing long length of GRP-130 sleeving fast and easy. Simply insert your wire bundle into the tool's shank and slide the tool along the split in the sleeving. The tool deposits the wires and allows the split to close correctly.



Part No.		Size		Wall Thickness (Min)		Ends per Carrier Alternating	Standard Put-Ups		Installation Tool Part No.
Black	Black w/ Tracer	Inch	mm	Inch	mm		Ft	m	
GRP-130-1/8	GRP-130NF-18	0.125	3.18	0.024	3.18	1/3	50, 200	15.2, 71	GRP-130T-1/4
GRP-130-1/4	GRP-130NF-14	0.250	6.35	0.025	6.35	1/3	50, 200	15.2, 71	GRP-130T-1/4
GRP-130-3/8	GRP-130NF-38	0.375	9.53	0.025	9.53	1/3	50, 100	15.2, 30.5	GRP-130T-1/2
GRP-130-1/2	GRP-130NF-12	0.500	12.70	0.025	12.70	1/3	50, 100	15.2, 30.5	GRP-130T-1/2
GRP-130-3/4	GRP-130NF-34	0.750	19.05	0.025	19.05	1/3	50, 100	15.2, 30.5	GRP-130T-3/4
GRP-130-1IN	GRP-130NF-11N	1.000	25.40	0.038	25.40	1/3	50, 100	15.2, 30.5	GRP-130T-1IN
GRP-130-1-1/4	GRP-130NF-1-14	1.250	31.75	0.038	31.75	1/3	25	7.6	GRP-130T-1-1/4
GRP-130-1-1/2	GRP-130NF-1-12	1.500	38.10	0.038	38.10	1/3	25	7.6	GRP-130T-1-1/4
GRP-130-2IN	GRP-130NF-2IN	2.000	50.80	0.038	50.80	2/3	25	7.6	GRP-130T-1-1/4*

*Designed for up to 1.22" cable diameter



FIT® Wire Management

Advanced Protection Expandable Sleeving GRP-160

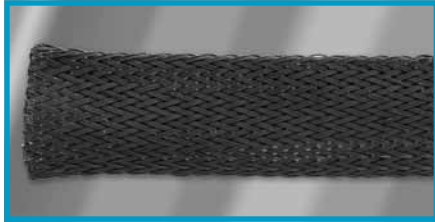

Color

- Black

Materials

- 20-mil nylon polyamide monofilament

Physical Properties

- Tensile strength: 19 psi (0.13 N/mm²)
- Specific gravity: 1.14 max

Chemical Properties

- Corrosive effects: noncorrosive
- Fungus resistance: no growth
- Water absorption: 2.50% max
- UV resistant
- Halogen free
- Lead free

Availability

See table
Reels may contain multiple lengths

An economical, easy-to-use choice for advanced abrasion and cut-through protection

- Extreme abrasion resistance without losing flexibility or durability
- Cuts cleanly with hot knife
- Resists fuels, solvents, salt water, chemicals, and UV
- Expandable to 150%

Operating Temperature

- -45°C to +150°C
- 256°C melt temperature

Part No.	Nominal Size		Expansion Range		Construction			Standard Put-Ups	
	Inch	mm	Inch	mm	Carriers	Yarns	Total	Ft	m
GRP-160-1/4	1/4	6.35	0.250 - 0.500	6.35 - 12.70	20	3	60	50, 250	15.2, 76
GRP-160-1/2	1/2	12.70	0.500 - 1.000	12.70 - 25.40	36	3	108	50, 250	15.2, 76
GRP-160-3/4	3/4	19.05	0.750 - 1.250	19.05 - 31.75	40	3	120	50, 250	15.2, 76
GRP-160-1IN	1	25.40	1.000 - 1.500	25.40 - 38.10	48	3	144	50, 250	15.2, 76
GRP-160-1-1/4	1-1/4	31.75	1.250 - 2.000	31.75 - 50.80	56	3	168	50, 250	15.2, 76
GRP-160-1-3/4	1-3/4	44.45	1.750 - 2.750	44.45 - 69.85	72	3	216	50, 250	15.2, 76
GRP-160-2-1/4	2-1/4	57.15	2.250 - 3.000	57.15 - 76.20	96	3	288	25, 100	7.6, 30.5



FIT® Wire Management

Advanced Chemical Resistance Expandable Sleeving GRP-170

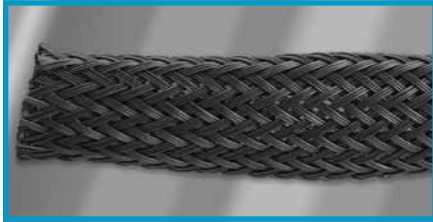

Color

- Black

Materials

- 8-mil-diameter polyphenylene sulfide (PPS) monofilaments
- Cuts with hot knife

Physical Properties

- Specific gravity: 1.37 max
- Flame resistant

Chemical Properties

- Corrosive effects: noncorrosive
- Fungus resistance: no growth
- Water absorption: 0.025% max
- Low outgassing
- UV resistant
- Halogen free
- Lead free

Availability

See table
Reels may contain multiple lengths

The extremely lightweight sleeving that is impervious to virtually all chemicals

UL 94V-0 FAR 25

- Resists acids, bases, solvents, and fuels
- Ultra-lightweight
- High abrasion resistance
- Expandable to 150%
- Flame resistant
- Cuts cleanly with hot knife

Operating Temperature

- -70°C to +200°C
- 285°C melt temperature

Part No.	Nominal Size		Expansion Range		Construction			Standard Put-Ups	
	Inch	mm	Inch	mm	Carriers	Yarns	Total	Ft	m
GRP-170-1/8	1/8	3.18	0.094 - 0.250	2.38 - 6.35	32	2	64	100, 500	30.5, 152
GRP-170-1/4	1/4	6.35	0.125 - 0.375	3.18 - 9.53	48	2	96	100, 500	30.5, 152
GRP-170-1/2	1/2	12.70	0.250 - 0.750	6.35 - 19.05	56	3	168	100, 500	30.5, 152
GRP-170-3/4	3/4	19.05	0.500 - 1.250	12.70 - 31.75	72	3	216	50, 250	15.2, 76
GRP-170-1-1/4	1-1/4	31.75	0.750 - 1.750	19.05 - 44.45	96	4	384	50, 250	15.2, 76
GRP-170-1-3/4	1-3/4	44.45	1.250 - 2.500	31.75 - 63.50	120	4	480	50, 250	15.2, 76

FIT® Wire Management

Maximum Performance Expandable Sleeving GRP-180

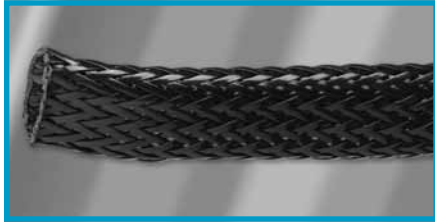

Color

- Black

Materials

- Flat 20-mil nylon filaments
- Cuts with hot knife

Physical Properties

- Tensile strength: 19 psi (0.13 N/mm²)
- Specific gravity: 1.12 max

Chemical Properties

- Corrosive effects: noncorrosive
- Fungus resistance: no growth
- Water absorption: 2.50% max
- UV resistant
- Lead free

Availability

See table
Reels may contain multiple lengths

Superior abrasion resistance, a wide operating temperature range, easy installation for industrial, solar, and high-abrasion applications

- Superior abrasion resistance
- Easy to install
- Resists fuels, solvents, chemicals, salt water, and UV
- Smooth inner wall to prevent internal abrasion damage

Operating Temperature

- -60°C to +150°C
- 265°C melt temperature

Part No.	Nominal Size		Expansion Range		Construction			Standard Put-Ups	
	Inch	mm	Inch	mm	Carriers	Yarns	Total	Ft	m
GRP-180-1/2	1/2	12.70	0.375 - 0.625	9.53 - 15.88	24	1	24	50, 250	15.2, 76
GRP-180-3/4	3/4	19.05	0.625 - 1.000	15.88 - 25.40	36	1	36	50, 250	15.2, 76
GRP-180-1IN	1	25.40	0.875 - 1.250	22.22 - 31.75	44	1	44	50, 250	15.2, 76
GRP-180-1-1/4	1-1/4	31.75	1.000 - 1.500	25.40 - 38.10	48	1	48	25, 100	7.6, 30.5
GRP-180-1-3/4	1-3/4	44.45	1.500 - 2.000	38.10 - 50.80	80	1	80	25, 100	7.6, 30.5
GRP-180-2IN	2	50.80	1.750 - 2.750	44.45 - 69.85	96	1	96	25, 100	7.6, 30.5

FIT® Wire Management

Extreme Performance Sleeving

GRP-200

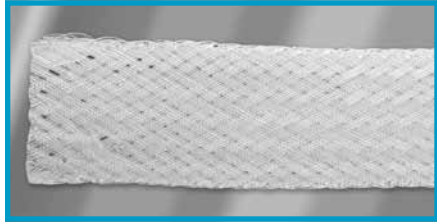

Color

- Natural

Materials

- 16-mil PTFE filaments
- Cuts with hot knife or hot wire

Physical Properties

- Specific gravity: 2.15 max

Chemical Properties

- Corrosive effects: noncorrosive
- Fungus resistance: no growth
- Water absorption: 0.01% max
- Vacuum outgassing: 95.0% max
- Lead free

Availability

See table
Spools may contain multiple lengths

The high-temperature choice for aerospace, military, and high-tech applications where thermal stability and low outgassing are critical

FAR 25

- Cut and abrasion resistant
- Flame resistant
- Resists virtually all chemicals and UV
- Thermally stable
- Low outgassing
- Suitable for plenum use

Operating Temperature

- -70°C to +280°C
- 310°C melt temperature

Part No.	Nominal Size		Expansion Range		Construction			Standard Put-Ups	
	Inch	mm	Inch	mm	Carriers	Yarns	Total	Ft	m
GRP-200-1/8	1/8	3.18	0.094 - 0.250	2.38 - 6.35	24	1	25	50, 250	15.2, 76
GRP-200-1/4	1/4	6.35	0.188 - 0.375	4.76 - 9.53	32	1	32	50, 250	15.2, 76
GRP-200-3/8	3/8	9.53	0.250 - 0.750	6.35 - 19.06	40	3	120	50, 250	15.2, 76
GRP-200-1/2	1/2	12.70	0.375 - 0.875	9.53 - 22.23	48	3	144	50, 250	15.2, 76
GRP-200-3/4	3/4	19.05	0.625 - 1.250	15.88 - 31.75	64	3	192	50, 250	15.2, 76
GRP-200-1-1/4	1-1/4	31.75	1.125 - 1.500	28.58 - 38.10	72	3	216	25, 100	7.6, 30.5
GRP-200-1-3/4	1-3/4	44.45	1.375 - 1.750	34.93 - 44.45	80	4	240	25, 100	7.6, 30.5
GRP-200-2IN	2	50.80	1.688 - 2.125	42.88 - 53.98	96	3	288	25, 100	7.6, 30.5

FIT® Wire Management

Expandable Braided Sleeving

XS-100HD

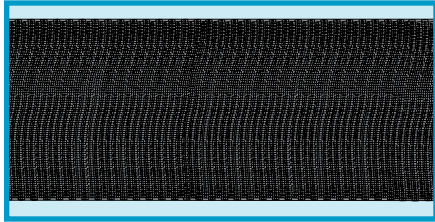

UL 224
UL UZKX2
CSA 5836 01

- Extremely flexible
- Light weight
- Easy to install

Operating Temperature

- -70°C to +125°C
- 250°C melt temperature

Color

- Black

Material

- Heavy-duty braided PET

Physical Properties

- Tensile strength: 90,000 psi (620 N/mm²)
- Elongation: 25% min.
- Specific gravity: 1.31 max.

Chemical Properties

- Corrosive effect: none
- Fungus resistance: no growth
- Halogen free
- Lead free

Availability

See table

Spools may contain multiple lengths

Part No.	Inside Diameter, Min.		Expanded Inside Diameter, Max.		Wall Thickness		Construction			Standard Put-Ups	
	Inch	mm	Inch	mm	Inch	mm	Carriers	Yarns	Total	Ft	m
XHD3/8	0.188	4.78	0.750	19.05	0.042	1.07	24	3	72	500	152
XHD5/8	0.313	7.95	1.000	25.40	0.042	1.07	32	3	96	500	152
XHD1IN	0.500	12.70	1.500	38.10	0.042	1.07	48	3	144	250	76
XHD1-1/2	1.000	25.40	2.000	50.80	0.042	1.07	72	3	216	200	61
XHD2IN	1.500	38.10	3.000	76.20	0.042	1.07	93	3	288	100	30.5

FIT® Wire Management

Braided Sleeving

XS-200N

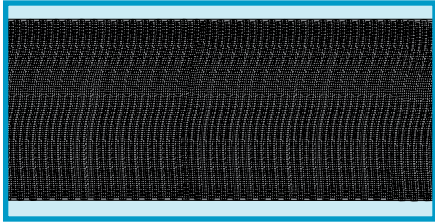

MIL-S-47053
CID A-A-59301

- Extremely durable
- Abrasion resistant
- Tight weave with excellent flexibility

Operating Temperature

- -45°C to +120°C
- 250°C melt temperature

Color

- Black

Material

- Braided nylon

Physical Properties

- Tensile strength: 80,000 psi (551 N/mm²)
- Specific gravity: 1.14

Chemical Properties

- Corrosive effect: none
- Fungus resistance: no growth
- Water absorption: 0.04%, max.
- Halogen free
- Lead free

Electrical Properties

- Dielectric strength: 4 V/mil (1.57 kV/cm)

Availability

See table

Spools may contain multiple lengths

Part No.	Inside Diameter, Min.		Wall Thickness		Construction			Standard Put-Ups	
	Inch	mm	Inch	mm	Carriers	Yarns	Total	Ft	m
XS-200N-1/8	0.125	3.18	0.020	0.51	28	3	84	100, 1000	30.5, 305
XS-200N-1/4	0.250	6.35	0.032	0.81	48	4	192	100, 500	30.5, 152
XS-200N-3/8	0.375	9.53	0.032	0.81	52	5	260	100, 500	30.5, 152
XS-200N-1/2	0.500	12.70	0.035	0.89	72	6	432	100	30.5
XS-200N-3/4	0.750	19.05	0.035	0.89	72	9	648	100, 250	30.5, 76
XS-200N-1IN	1.000	25.40	0.045	1.14	72	16	1152	100	30.5

FIT® Wire Management

Abrasion-Resistant Nylon Sleevings

XS300



Color

- Black

Materials

- 45-mil-thick nylon
- Cuts with scissors

Physical Properties

- Specific gravity: 1.14

Chemical Properties

- Corrosive effects: noncorrosive
- Fungus resistance: no growth
- Water absorption: 2.70% max
- Halogen free
- Lead free

Availability

25 ft (7.6 m)
100 ft (30.4 m) for 0.71 through 1.59 sizes only

Professional-grade protection with smooth inner wall to prevent internal abrasion damage

- Excellent abrasion resistance
- Tightly woven, nonexpandable
- Cuts cleaning with scissors
- Deflects high-pressure hose ruptures
- Resists fuels, chemicals, UV, rot, and vermin
- ISO 6945 certified
- MSHA approved “Accepted flame-resistant solid products taken into mines”

Operating Temperature

- -45°C to +120°C
- 210°C melt temperature

Part No.	Size		Wall Thickness (Min)	
	Inch	mm	Inch	Mm
XS300071	0.71	18.03	0.045	1.14
XS300083	0.83	21.08	0.045	1.14
XS300092	0.92	23.37	0.045	1.14
XS300100	1.00	25.40	0.045	1.14
XS300113	1.13	28.70	0.045	1.14
XS300125	1.25	31.75	0.045	1.14
XS300134	1.34	34.04	0.045	1.14
XS300159	1.59	40.39	0.045	1.14
XS300175	1.75	44.45	0.045	1.14
XS300207	2.07	52.58	0.045	1.14
XS300238	2.38	60.45	0.045	1.14
XS300254	2.54	64.52	0.045	1.14
XS300286	2.86	72.64	0.045	1.14
XS300334	3.34	84.84	0.045	1.14
XS300366	3.66	92.96	0.045	1.14

FIT® Wire Management

Expandable Braided Sleeving

ZIP-GRP

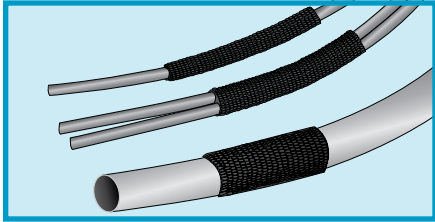

UL UZKYZ
UL 94V-0
CSA 5836 01

- Unlimited breakouts
- Abrasion and cut-through resistance
- Oil and solvent resistance

Operating Temperature

- -70°C to +125°C
- 230°C melt temperature

Color

- Black

Material

- Braided PET with hook and loop closure
- Cuts with hot knife

Physical Properties

- Tensile strength: 85,000 psi (586 N/mm²)
- Specific gravity: 1.38

Chemical Properties

- Corrosive effect: None
- Fungus resistance: no growth
- Water absorption: 0.15% max.
- Halogen free
- Lead free
- Chemically inert
- UV resistant

Availability

25 ft (7.6 m)
 50 ft (15.2 m)

Spools may contain multiple lengths

Part No.	Inside Diameter, Min.		Expanded Inside Diameter, Max.		Wall Thickness		Construction		
	Inch	mm	Inch	mm	Inch	mm	Carriers	Yarns	Total
ZIP-GRP-7/8	0.500	12.70	2.375	60.33	0.025	0.64	88	4	220
ZIP-GRP-1-1/2	1.500	38.10	3.500	88.90	0.025	0.64	105	4	420
ZIP-GRP-2	2.000	50.80	4.500	114.30	0.025	0.64	137	4	548



FIT® Wire Management

Lacing Tape



A-A-52080 Type 1

- High tensile strength
- Good chemical resistance
- Excellent abrasion resistance
- Excellent knot retention

See table for specifications.

A-A-52080 (MIL-T-43435B Type I)

- Flat braid made from high-tenacity continuous nylon yarn

Operating temperature:

- -55° C to +121° C

Elongation:

- 40% max

Finish weight (impregnated % of material by weight)

- Finish A (natural)
- Finish B (wax): 15% - 32%
- Finish C (synthetic rubber/elastomer): 7% - 17%
- Finish E (synthetic resin/vinyl): 15% - 30%

Finishes

A. Natural, No finish

B. Wax: A microcrystalline wax with a melting point above 54°C compounded with a fungicide that does not contain either copper or mercuric materials. Excellent knot retention, yet the finish does not have too great a “waxy” feel to the user. Microcrystalline wax is soft, pliable, and easy to tie.

C. Synthetic Rubber or Elastomer:

A special continuous coating of fungistatic synthetic rubber containing no corrosive compounding ingredients. Knots tied with this finish will not slip. This finish will not flake or dust.

D: Glass/TFE:

The glass/TFE combination has excellent tensile strength and abrasion resistance. Also resists fungus, acids and flames.

E. Synthetic Resin or Vinyl:

A thermoplastic synthetic resin with a melting point above 177°C for use where a “wax free” type is specified. It is a non-dusting or flaking, dry finish with good knot tying qualities.

Part No.	Finish	Color	Width, Nom		Thickness, Nom.		Break Strength, Min.		Availability*	
			Inch	mm	Inch	mm	lb	kg	Yd	m
801530W	A	Natural	0.050	1.27	0.010	0.25	15	6.8	500	457
801536B	B	Black	0.050	1.27	0.010	0.25	15	6.8	500	457
801536W	B	Natural	0.050	1.27	0.010	0.25	15	6.8	500	457
802534B	B	Black	0.060	1.52	0.012	0.30	25	11.3	500	457
802534W	B	Natural	0.060	1.52	0.012	0.30	25	11.3	500	457
LC-134	B	Black, White	0.060	1.52	0.012	0.30	25	11.3	500	457
805032B	E	Black	0.085	2.16	0.014	0.36	50	22.7	500	457
805032W	E	Natural	0.085	2.16	0.014	0.36	50	22.7	500	457
805036B	B	Black	0.085	2.16	0.014	0.36	50	22.7	500	457
805036W	B	Natural	0.085	2.16	0.014	0.36	50	22.7	500	457
805040B	C	Black	0.085	2.16	0.014	0.36	50	22.7	500	457
805040W	C	Natural	0.085	2.16	0.014	0.36	50	22.7	500	457
LC-143	E	Black, White	0.085	2.16	0.014	0.36	50	22.7	500	457
808036B	B	Black	0.110	2.79	0.015	0.38	80	36.3	250	228
808036W	B	White	0.110	2.79	0.015	0.38	80	36.3	250	228

*Bobbins/tubes may contain multiple lengths.



FIT® Wire Management

Lacing Tape



A-A-52081 (formerly MIL-T-43435B Type II)

- Flat braid made from high-tenacity continuous polyester yarn

Operating temperature:

- -73°C to +177°C

Elongation:

- 40% max

Finish weight (impregnated % of material by weight)

- Finish A (natural)
- Finish B (wax): 15% - 32%
- Finish C (synthetic rubber/elastomer): 7% - 17%
- Finish E (synthetic resin/vinyl): 15% - 30%

A-A-52083 (formerly MIL-T-43435B Type IV)

- Flat braid made from continuous filament glass yarn coated with PTFE before braiding

Operating temperature:

- Glass maintain strength and stability to 427°C

Elongation:

- 5% max

Finish weight (impregnated % of material by weight)

- Finish D (glass/TFE): 10% - 20%

Part No.	Finish	Color	Width, Nom.		Thickness, Nom.		Break Strength, Min.		Availability*	
			Inch	mm	Inch	mm	lb	kg	Yd	m
801566B	C	Black	0.050	1.27	0.010	0.25	15	6.8	500	457
802566B	C	Black	0.060	1.52	0.012	0.30	25	11.3	500	457
C164	B	Black, White	0.062	1.57	0.010	0.25	25	11.3	500	457
805058B	E	Black	0.085	2.16	0.014	0.36	50	22.7	500	457
805058W	E	Natural	0.085	2.16	0.014	0.36	50	22.7	500	457
805060B	A	Black	0.085	2.16	0.014	0.36	50	22.7	500	457
805062B	B	Black	0.085	2.16	0.014	0.36	50	22.7	500	457
805062W	B	Natural	0.085	2.16	0.014	0.36	50	22.7	500	457
805066W	C	Natural	0.085	2.16	0.014	0.36	50	22.7	500	457
C162	B	Black, White	0.085	2.16	0.014	0.36	50	22.7	500	457
808060W	A	Natural	0.110	2.79	0.015	0.38	80	36.3	500	457
808058B	E	Black	0.110	2.79	0.015	0.38	80	36.3	250	228
C160	B	Black, White	0.200	5.08	0.016	0.41	135	61.2	250	228

*Bobbins/tubes may contain multiple lengths.

Part No.	Finish	Color	Width, Nom.		Thickness, Nom.		Break Strength, Min.		Availability*	
			Inch	mm	Inch	mm	lb	kg	Yd	m
807510W	D	Natural	0.085	2.16	0.016	0.41	75	34.0	500	457
810010W	D	Natural	0.110	2.79	0.016	0.41	100	45.3	250	228

*Bobbins/tubes may contain multiple lengths.



FIT® Wire Management

Lacing Tape



A-A-52084 (formerly MIL-T-43435B Type V)

- Flat braid made from continuous filament aramid yarn

Operating temperature:

- -55°C to +260°C

Elongation:

- 40% max

Finish weight (impregnated % of material by weight)

- Finish C (synthetic rubber/elastomer): 7% - 17%

MIL-DTL-713 Type P

- Twisted nylon cord made from high-tenacity continuous filament yarn

Operating temperature:

- -55° C to +121°C

Elongation:

- 20% min.

Finish weight (impregnated % of material by weight)

- Finish B (wax): 20% - 32%

Telecommunications-Grade Polyester Yarn

- Round, twisted polyester cord made from high-tenacity industrial polyester fiber

Melt temperature (approx.):

- 121°C

Elongation:

- 17% - 27%

Finish weight (impregnated % of material by weight)

- 9 ply: 7% - 17%
- 12 ply: 35%

Part No.	Finish	Color	Width, Nom.		Thickness, Nom.		Break Strength, Min.		Availability*	
			Inch	mm	Inch	mm	lb	kg	Yd	m
803554	C	Natural	0.075	1.91	0.012	0.30	35	15.9	500	457

*Bobbins/tubes may contain multiple lengths.

Part No.	Finish	Color	Diameter, Nom.		Break Strength, Min.		Availability*	
			Inch	mm	lb	kg	lb	kg
803215B	B	Black	0.023	0.58	32	14.5	1	0.45
803215W	B	Natural	0.023	0.58	32	14.5	1	0.45
804812W	A	Natural	0.025	0.64	48	21.8	1	0.45
804814B	B	Black	0.025	0.64	48	21.8	1	0.45
804814W	B	Natural	0.025	0.64	48	21.8	1	0.45
807013B	B	Black	0.040	1.02	70	31.7	1	0.45
807013W	B	Natural	0.040	1.02	70	31.7	1	0.45

*Weight per spool; bobbins/tubes may contain multiple lengths.

Part No.	Finish	Color	Diameter, Nom.		Break Strength, Min.		Plies	Availability*	
			Inch	mm	lb	kg		lb	kg
812030W	Wax	Natural	0.030	0.76	32	14.5	9	0.5	0.22
815040W	Wax	Natural	0.030	0.76	32	14.5	12	0.5	0.22

*Weight per tube; bobbins/tubes may contain multiple lengths.



FIT® Wire Management

Tinned Copper Braid

Flat, Oval

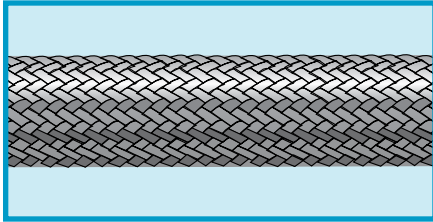

AA-59569A (as indicated)

Color

- Silver

Material

- Tinned copper braid

Availability

See table

Spools may contain multiple lengths

Part No.	Flat Width, Nom.		Thickness, Nom.		Braid Construction			AWG Equivalent, Approx.	CMA, Nom.	Current-Carrying Capacity	Standard Put-Ups	
	Inch	mm	Inch	mm	AWG of Individ. Ends	Carriers	No. of Individ. Ends				Amps	Ft
1221*	0.025	0.64	0.015	0.38	36	8	8	27	200	4	100, 500, 1000	30.5, 152, 305
1222*	0.032	0.81	0.020	0.50	36	16	16	24	400	6	100, 500, 1000	30.5, 152, 305
1223	0.047	1.19	0.020	0.50	36	24	24	22	600	7	100, 500, 1000	30.5, 152, 305
1224*	0.094	2.39	0.020	0.50	36	16	48	19	1200	11	100, 500, 1000	30.5, 152, 305
1229	0.125	3.18	0.020	0.50	36	24	72	18	1800	16	100, 500, 1000	30.5, 152, 305
1230	0.187	4.75	0.020	0.50	36	24	120	15	3000	25	100, 500, 1000	30.5, 152, 305
1231	0.250	6.35	0.030	0.76	36	24	168	14	4200	32	100, 500, 1000	30.5, 152, 305
1232*	0.385	9.78	0.030	0.76	36	48	288	12	7200	46	100, 500, 1000	30.5, 152, 305
1233/2*	0.500	12.70	0.030	0.76	36	48	384	10	9600	53	100, 500, 1000	30.5, 152, 305
1233	0.625	15.88	0.030	0.76	36	48	384	10	9600	53	100, 500, 1000	30.5, 152, 305
1234	0.750	19.05	0.040	1.02	36	48	864	7	20,800	85	100, 500, 1000	30.5, 152, 305
1235*	1.000	25.40	0.045	1.14	36	48	864	7	20,800	85	100, 500, 1000	30.5, 152, 305
1239	1.375	34.93	0.050	1.27	30	48	336	5	33,700	100	100, 500, 1000	30.5, 152, 305
1240	1.500	38.10	0.060	1.52	30	48	528	3	53,064	150	100	30.5
1241*	1.750	44.45	0.080	2.03	30	48	1248	2/0	125,424	280	100	30.5
1242*	2.000	50.80	0.120	3.05	30	48	1436	3/0	154,368	310	100	30.5
1242/4*	3.000	76.20	0.200	5.08	30	48	2256	4/0	225,000	390	100	30.5

*Not A-A-59569A.



FIT® Wire Wire Management

Tinned Copper Braid Flat, Oval

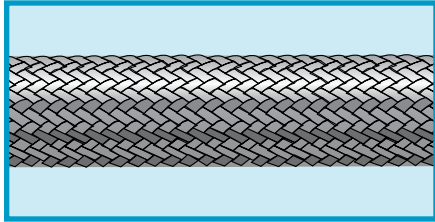

A-A-59551 (as indicated)

Color

- Silver

Material

- Tinned copper braid

Availability

See table

Spools may contain multiple lengths

Part No.	Inside Diameter, Nom.		Braid Construction			AWG Equivalent, Approx.	CMA, Nom.	Current-Carrying Capacity	Standard Put-Ups	
	Inch	mm	AWG of Individ. Ends	Carriers	No. of Individ. Ends				Amps	Ft
2132	1/16	1.59	34	16	32	19	1192	11	100, 500, 1000	30.5, 152, 305
2138	11/64	4.37	34	24	120	14	4770	32	100, 500, 1000	30.5, 152, 305
2140*	3/16	4.76	34	24	144	13	5724	38	100, 500	30.5, 152
2142*	1/4	6.35	34	24	168	12	6678	41	100, 500	30.5, 152
2144*	3/8	9.53	34	24	192	11	7632	46	100, 500,	30.5, 152
2146	1/2	12.70	34	48	336	9	13,356	62	100	30.5
2148*	5/8	15.88	34	48	384	8	14,264	64	100	30.5
2150*	11/16	17.46	34	48	480	7	19,080	81	100	30.5
2152	25/32	19.84	34	48	528	7	20,988	85	100	30.5

*Not A-A-59551.

Bare Copper Braid Flat

Material

- Bare copper braid

Availability

See table

Spools may contain multiple lengths

Part No.	Dimensions, Nom.		Braid Construction			CMA, Nom.	Current-Carrying Capacity	Standard Put-Ups	
	Inch	mm	AWG of Individ. Ends	Carriers	No. of Individ. Ends			Amps	Ft
95106	0.062 x 0.016	1.57 x 0.41	20	16	96	949	10.2	100, 500, 1000	30.5, 152, 305
95079	0.250 x 0.030	6.35 x 0.76	14	27	168	4200	27.9	100, 500, 1000	30.5, 152, 305



FIT® Wire Wire Management

Tinned Copper Braid

Tubular

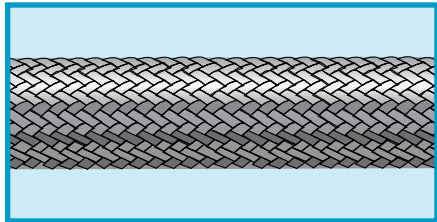

A-A-59569

Color

- Silver

Material

- Tinned copper braid

Availability

See tables

Spools may contain multiple lengths

Tinned Copper

Part No.	Inside Diameter, Nom.		Braid Construction			AWG Equivalent, Approx.	CMA, Nom.	Current-Carrying Capacity	Standard Put-Ups	
	Inch	mm	AWG of Indiv. Ends	Carriers	No. of Indiv. Ends				Amps	Ft
2160	0.031	0.79	36	24	24	22	600	7	100, 250	30.6, 76
2162	0.062	1.57	36	24	48	19	1200	11	100, 250	30.6, 76
2163	0.078	1.98	36	24	72	18	1800	16	100, 250	30.6, 76
2164	0.109	2.77	36	24	96	16	2400	19	100, 250	30.6, 76
2166	0.125	3.18	36	24	120	15	3000	25	100, 250	30.6, 76
2167	0.156	3.96	36	24	240	12	6000	40	100, 250	30.6, 76
2168	0.171	4.34	36	24	168	14	4200	32	100, 250	30.6, 76
2170	0.203	5.16	34	24	192	11	7630	46	100	30.5
2171	0.250	6.35	36	24	384	10	9600	53	100	30.5
2171/1	0.281	7.14	30	24	120	9	12,060	60	100	30.5
2172	0.375	9.53	36	48	384	10	9600	53	100	30.5
2173	0.437	11.10	30	24	240	6	24,120	90	100	30.5
2174	0.500	12.70	36	48	528	9	13,200	62	100	30.5
2175	0.462	11.73	30	48	480	3	48,240	145	100	30.5
2175/1	0.656	16.66	30	48	768	1	77,180	190	100	30.5
2176	0.781	19.84	36	48	864	7	21,600	88	100	30.5

Extra-Large Tinned Copper

Part No.	Inside Diameter, Nom.		Braid Construction			AWG Equivalent, Approx.	CMA, Nom.	Current-Carrying Capacity	Standard Put-Ups	
	Inch	mm	AWG of Indiv. Ends	Carriers	No. of Indiv. Ends				Amps	Ft
2177	0.875	22.23	30	48	336	5	33,700	100	100	30.5
2178	1.000	25.40	30	48	384	4	38,600	120	100	30.5
2179	1.125	28.58	30	48	432	4	43,330	130	100	30.5
2180*	1.250	31.75	30	48	480	3	48,150	145	100	30.5
2181	1.375	34.93	30	48	528	3	53,000	150	100	30.5
2182	1.500	38.10	30	48	576	2	57,775	165	100	30.5

*Not A-A-59569.



FIT® Wire Wire Management

Silver-Plated Copper Braid

Tubular

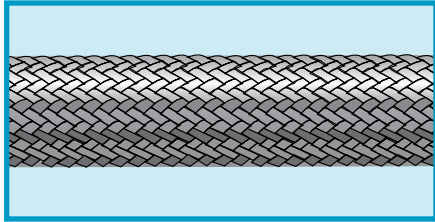

A-A-59569

Color

- Silver

Material

- Silver-plated copper braid

Availability

See table

Spools may contain multiple lengths

Silver-Plated

Part No.	Inside Diameter, Nom.		Braid Construction			AWG Equivalent, Approx.	CMA, Nom.	Current-Carrying Capacity	Standard Put-Ups	
	Inch	mm	AWG of Indiv. Ends	Carriers	No. of Indiv. Ends				Amps	Ft
2191	1/16	1.59	36	24	48	19	1200	11	100	30.5
2193	7/64	2.78	36	24	96	16	2400	19	100	30.5
2194	1/8	3.18	36	24	120	15	3000	25	100	30.5
2195	5/32	3.97	36	24	240	12	6000	40	100	30.5
2196	11/64	4.37	36	24	168	14	4200	32	100	30.5
2197	13/64	5.16	34	24	192	11	7640	46	100	30.5
2198	1/4	6.35	36	24	384	10	9600	53	100	30.5

Technical Information



AWG/Metric Conductor Table

AWG	Stranding	Approx OD		Area		Weight		DC Resistance (Bare)*		DC Resistance (Tinned)*	
		Inch	mm	CMA	mm ²	Lb/1000 ft	kg/km	Ohms/1000 ft	Ohms/km	Ohms/1000 ft	Ohms/km
38	Solid	0.0040	0.102	16.0	0.008	0.048	0.071	648	2126	696	2283
38	7/46	0.0047	0.119	17.2	0.009	0.053	0.079	614	2014	659	2162
36	Solid	0.0050	0.127	25.0	0.013	0.076	0.113	415	1362	445	1460
36	7/44	0.0060	0.152	28.0	0.014	0.086	0.128	378	1240	406	1332
34	Solid	0.0063	0.160	39.7	0.020	0.120	0.179	261	856	280	919
34	7/42	0.0075	0.191	43.8	0.022	0.135	0.201	242	794	260	853
32	Solid	0.0080	0.203	64.0	0.032	0.194	0.289	162	531	174	571
32	7/40	0.0093	0.236	67.3	0.034	0.208	0.310	157	515	169	554
32	19/44	0.0100	0.254	76.0	0.039	0.235	0.350	139	456	149	489
30	Solid	0.0100	0.254	100	0.051	0.303	0.451	104	341	111	364
30	7/38	0.0120	0.305	112	0.057	0.346	0.515	94.5	310	101	331
30	19/42	0.0125	0.318	119	0.060	0.367	0.546	89.1	292	95.6	314
28	Solid	0.0126	0.320	159	0.081	0.481	0.716	65.2	214	69.3	227
28	7/36	0.0150	0.381	175	0.089	0.540	0.804	60.4	198	64.9	213
28	19/40	0.0155	0.394	183	0.093	0.564	0.839	57.9	190	62.2	204
27	7/35	0.017	0.432	220	0.111	0.679	1.01	48.1	158	51.7	170
26	Solid	0.0159	0.404	253	0.128	0.766	1.14	41.0	135	43.5	143
26	7/34	0.019	0.483	278	0.141	0.858	1.28	38.1	125	40.9	134
26	10/36	0.019	0.483	250	0.127	0.772	1.15	42.3	139	45.4	149
26	19/38	0.020	0.508	304	0.154	0.939	1.40	34.8	114	37.4	123
25	7/0067	0.020	0.508	314	0.159	0.970	1.44	33.7	111	36.1	118
25	7/33	0.021	0.533	353	0.179	1.09	1.62	30.0	98.4	32.2	106
25	40/40	0.023	0.584	384	0.195	1.19	1.77	27.5	90.2	29.5	96.8
24	Solid	0.0201	0.511	404	0.205	1.22	1.82	25.7	84.3	26.7	87.6
24	7/32	0.024	0.610	448	0.227	1.38	2.05	23.6	77.4	25.3	83.0
24	10/34	0.023	0.584	397	0.201	1.23	1.83	26.6	87.3	28.6	93.8
24	19/36	0.025	0.635	475	0.241	1.47	2.19	22.3	73.2	23.9	78.4
22	Solid	0.0253	0.643	640	0.324	1.94	2.89	16.2	53.1	16.9	55.4
22	7/0096	0.029	0.737	645	0.327	1.99	2.96	16.4	53.8	17.6	57.7
22	7/30	0.030	0.762	700	0.355	2.16	3.21	15.1	49.5	16.2	53.1
22	16/34	0.030	0.762	635	0.322	1.96	2.92	16.7	54.8	17.9	58.7
22	19/34	0.0315	0.800	754	0.382	2.33	3.47	14.0	45.9	15.1	49.5
20	Solid	0.032	0.813	1024	0.519	3.10	4.61	10.1	33.1	10.5	34.4
20	7/0121	0.036	0.914	1022	0.518	3.16	4.70	10.4	34.1	11.0	36.1
20	7/28	0.038	0.965	1113	0.564	3.44	5.12	9.5	31.2	10.1	33.1
20	10/30	0.037	0.940	1000	0.507	3.09	4.60	10.6	34.8	11.4	37.4
20	19/32	0.040	1.016	1216	0.616	3.75	5.58	8.7	28.5	9.3	30.6
20	26/34	0.038	0.965	1032	0.523	3.19	4.75	10.2	33.5	11.0	36.1
20	41/36	0.037	0.940	1025	0.519	3.16	4.70	10.3	33.8	11.1	36.4
20	63(7x9)/38	0.040	1.016	1008	0.511	3.17	4.72	10.7	35.1	11.5	37.7

*Nominal resistance at 20°C.

AWG/Metric Conductor Table

AWG	Stranding	Approx OD		Area		Weight		DC Resistance (Bare)*		DC Resistance (Tinned)*	
		Inch	mm	CMA	mm ²	Lb/1000 ft	kg/km	Ohms/1000 ft	Ohms/km	Ohms/1000 ft	Ohms/km
18	Solid	0.040	1.016	1624	0.823	4.92	7.32	6.39	21.0	6.64	21.8
18	7/.0152	0.046	1.168	1617	0.819	4.99	7.43	6.54	21.5	6.95	22.8
18	7/26	0.048	1.219	1771	0.897	5.47	8.14	5.97	19.6	6.34	20.8
18	16/30	0.047	1.194	1600	0.811	4.94	7.35	6.61	21.7	7.10	23.3
18	19/30	0.050	1.270	1900	0.963	5.87	8.74	5.57	18.3	5.98	19.6
18	41/34	0.047	1.194	1628	0.825	5.03	7.49	6.50	21.3	6.98	22.9
18	65/36	0.047	1.194	1625	0.823	5.02	7.47	6.51	21.4	6.99	22.9
18	105(7x15)/38	0.052	1.321	1680	0.851	5.29	7.87	6.42	21.1	6.89	22.6
16	Solid	0.051	1.295	2581	1.31	7.81	11.62	4.02	13.2	4.18	13.7
16	7/.0192	0.058	1.473	2583	1.31	7.98	11.88	4.10	13.5	4.35	14.3
16	7/24	0.060	1.524	2828	1.43	8.73	12.99	3.74	12.3	3.89	12.8
16	19/.0117	0.059	1.499	2603	1.32	8.04	11.96	4.06	13.3	4.32	14.2
16	19/29	0.057	1.448	2432	1.23	7.51	11.18	4.35	14.3	4.62	15.2
16	26/30	0.060	1.524	2600	1.32	8.03	11.95	4.07	13.4	4.37	14.3
16	65/34	0.059	1.499	2580	1.31	7.97	11.86	4.10	13.5	4.40	14.4
16	168(7x24)/38	0.067	1.702	2688	1.36	8.46	12.59	4.01	13.2	4.31	14.1
14	Solid	0.064	1.626	4109	2.08	12.4	18.45	2.52	8.27	2.62	8.60
14	7/22	0.076	1.930	4480	2.27	13.8	20.53	2.36	7.74	2.46	8.07
14	7/.0242	0.073	1.854	4102	2.08	12.7	18.90	2.58	8.46	2.68	8.79
14	19/.0147	0.074	1.880	4104	2.08	12.7	18.90	2.58	8.46	2.74	8.99
14	19/27	0.071	1.803	3838	1.94	11.8	17.56	2.76	9.06	2.93	9.61
14	41/30	0.074	1.880	4100	2.08	12.7	18.90	2.58	8.46	2.77	9.09
14	105/34	0.075	1.905	4168	2.11	12.9	19.20	2.54	8.33	2.72	8.92
14	266(7x38)/38	0.080	2.032	4256	2.16	13.4	19.94	2.53	8.30	2.72	8.92
12	Solid	0.081	2.057	6529	3.31	19.8	29.47	1.59	5.22	1.65	5.41
12	7/20	0.096	2.438	7168	3.63	22.1	32.88	1.48	4.85	1.53	5.02
12	7/.0305	0.092	2.337	6510	3.30	20.1	29.91	1.62	5.31	1.69	5.54
12	19/.0185	0.093	2.362	6498	3.29	20.1	29.91	1.63	5.35	1.73	5.68
12	19/25	0.090	2.286	6080	3.08	18.8	27.98	1.74	5.71	1.85	6.07
12	65/30	0.093	2.362	6500	3.29	20.1	29.91	1.63	5.35	1.75	5.74
12	168(7x24)/34	0.106	2.692	6670	3.38	21.0	31.25	1.62	5.31	1.74	5.71
12	413(7x59)/38	0.106	2.692	6608	3.35	20.8	30.95	1.63	5.35	1.75	5.74
10	Solid	0.102	2.591	10384	5.26	31.4	46.73	0.999	3.28	1.04	3.41
10	7/.0385	0.116	2.946	10374	5.26	32.0	47.62	1.02	3.35	1.06	3.48
10	19/.0234	0.117	2.972	10412	5.28	32.1	47.77	1.02	3.35	1.06	3.48
10	19/23	0.113	2.870	9709	4.92	30.0	44.64	1.09	3.58	1.13	3.71
10	37/.0167	0.117	2.972	10323	5.23	31.9	47.47	1.02	3.35	1.09	3.58
10	37/26	0.111	2.819	9361	4.74	28.9	43.01	1.13	3.71	1.20	3.94
10	105/30	0.118	2.997	10500	5.32	32.4	48.22	1.01	3.31	1.08	3.54
10	658(7x94)/38	0.132	3.353	10528	5.33	33.1	49.26	1.02	3.35	1.10	3.61

*Nominal resistance at 20°C.

AWG/Metric Conductor Table

AWG	Stranding	Approx OD		Area		Weight		DC Resistance (Bare)*		DC Resistance (Tinned)*	
		Inch	mm	CMA	mm ²	Lb/1000 ft	kg/km	Ohms/1000 ft	Ohms/km	Ohms/1000 ft	Ohms/km
8	Solid	0.129	3.277	16512	8.37	50.0	74.41	0.628	2.06	0.646	2.12
8	19/.0295	0.148	3.759	16530	8.38	51.0	75.90	0.640	2.10	0.665	2.18
8	19/21	0.143	3.632	15428	7.82	47.6	70.84	0.686	2.25	0.713	2.34
8	49(7x7)/.0184	0.166	4.216	16611	8.42	52.3	77.83	0.649	2.13	0.690	2.26
8	65/26	0.148	3.759	16445	8.33	50.8	75.60	0.643	2.11	0.683	2.24
8	133(7x19)/29	0.169	4.293	17024	8.63	53.6	79.77	0.634	2.08	0.673	2.21
8	168(7x24)/30	0.167	4.242	16800	8.51	52.9	78.72	0.642	2.11	0.689	2.26
8	266(7x38)/32	0.166	4.216	17024	8.63	53.6	79.77	0.634	2.08	0.680	2.23
6	19/.0372	0.186	4.724	26296	13.3	81.2	120.84	0.402	1.32	0.418	1.37
6	19/19	0.180	4.572	24491	12.4	75.6	112.51	0.432	1.42	0.449	1.47
6	37/23	0.158	4.013	18907	9.58	58.4	86.91	0.559	1.83	0.582	1.91
6	49(7x7)/.0231	0.208	5.283	26166	13.3	81.6	121.43	0.408	1.34	0.425	1.39
6	105/26	0.188	4.775	26565	13.5	82.0	122.03	0.398	1.31	0.423	1.39
6	133(7x19)/27	0.213	5.410	26866	13.6	84.6	125.90	0.401	1.32	0.426	1.40
6	266(7x38)/30	0.210	5.334	26600	13.5	83.7	124.56	0.405	1.33	0.435	1.43
6	413(7x59)/32	0.212	5.385	26432	13.4	83.2	123.82	0.408	1.34	0.438	1.44
4	19/.0469	0.235	5.969	41800	21.2	129	191.97	0.253	0.830	0.263	0.863
4	49(7x7)/.0292	0.263	6.680	41797	21.2	130	193.46	0.256	0.840	0.266	0.873
4	133(7x19)/25	0.269	6.833	42560	21.6	134	199.41	0.253	0.830	0.269	0.883
4	168(7x24)/26	0.266	6.756	42504	21.5	134	199.41	0.254	0.833	0.270	0.886
4	413(7x59)//30	0.265	6.731	41300	20.9	130	193.46	0.261	0.856	0.280	0.919
4	420(7x60)/30	0.268	6.807	42000	21.3	132	196.44	0.257	0.843	0.276	0.906
4	665(19x35)/32	0.270	6.858	42560	21.6	134	199.41	0.253	0.830	0.272	0.892
2	19/.0591	0.296	7.518	66367	33.6	205	305.07	0.159	0.522	0.166	0.545
2	133(7x19)/23	0.339	8.611	67963	34.4	214	318.47	0.159	0.522	0.165	0.541
2	259(7x37)/26	0.334	8.484	65527	33.2	207	308.05	0.165	0.541	0.176	0.577
2	266(7x38)/26	0.334	8.484	67298	34.1	212	315.49	0.160	0.525	0.170	0.558
2	665 (7x95)/30	0.336	8.534	66500	33.7	209	311.03	0.162	0.531	0.174	0.571
2	665(19x35)/30	0.338	8.585	66500	33.7	209	311.03	0.162	0.531	0.174	0.571
2	1045(19x55)/32	0.342	8.687	66880	33.9	213	316.98	0.163	0.535	0.175	0.574
1	19/.0664	0.332	8.433	83771	42.4	259	385.43	0.126	0.413	0.131	0.430
1	133(7x19)/22	0.380	9.652	85120	43.1	268	398.83	0.127	0.417	0.132	0.433
1	259(7x37)/25	0.376	9.550	82880	42.0	262	389.90	0.131	0.430	0.139	0.456
1	836(19x44)/30	0.383	9.728	83600	42.4	266	395.85	0.130	0.427	0.140	0.459
1/0	19/.0745	0.373	9.474	105450	53.4	326	485.14	0.100	0.328	0.104	0.341
1/0	133(7x19)/21	0.428	10.871	107996	54.7	340	505.98	0.100	0.328	0.104	0.341
1/0	259(7x37)/24	0.422	10.719	104636	53.0	331	492.58	0.104	0.341	0.108	0.354
1/0	1045(19x55)/30	0.428	10.871	104500	53.0	332	494.07	0.104	0.341	0.112	0.367
1/0	1064(19x56)/30	0.430	10.922	106400	53.9	338	503.00	0.102	0.335	0.110	0.361
2/0	19/.0837	0.419	10.643	133114	67.4	411	611.64	0.079	0.259	0.083	0.272
2/0	133(7x19)/20	0.480	12.192	136192	69.0	429	638.42	0.079	0.259	0.082	0.269
2/0	259(7x37)/23	0.474	12.040	132349	67.1	419	623.54	0.082	0.269	0.085	0.279
2/0	1323(7x7x27)/30	0.539	13.691	132300	67.0	424	630.98	0.083	0.272	0.089	0.292
2/0	1330(19x70)/30	0.483	12.268	133000	67.4	427	635.45	0.083	0.272	0.089	0.292

*Nominal resistance at 20°C.

AWG/Metric Conductor Table

AWG	Stranding	Approx OD		Area		Weight		DC Resistance (Bare)*		DC Resistance (Tinned)*	
		Inch	mm	CMA	mm ²	Lb/1000 ft	kg/km	Ohms/1000 ft	Ohms/km	Ohms/1000 ft	Ohms/km
3/0	19/.0940	0.470	11.938	167884	85.1	518	770.87	0.063	0.207	0.066	0.217
3/0	133(7x19)/19	0.538	13.665	171437	86.9	540	803.61	0.063	0.207	0.065	0.213
3/0	259(7x37)/22	0.530	13.462	165760	84.0	524	779.80	0.065	0.213	0.068	0.223
3/0	1666(7x7x34)/30	0.604	15.342	166600	84.4	535	796.17	0.066	0.217	0.071	0.233
3/0	1672(19x88)/30	0.540	13.716	167200	84.7	536	797.66	0.066	0.217	0.071	0.233
4/0	19/.1055	0.528	13.411	211470	107	653	971.77	0.050	0.164	0.051	0.167
4/0	133(7x19)/18	0.604	15.342	215992	109	680	1011.95	0.050	0.164	0.052	0.171
4/0	259(7x37)/21	0.598	15.189	210308	107	665	989.63	0.052	0.171	0.054	0.177
4/0	2107(7x7x43)/30	0.681	17.297	210700	107	676	1006.00	0.052	0.171	0.056	0.184
4/0	2109 (37x57)/30	0.590	14.986	210900	107	677	1007.49	0.052	0.171	0.056	0.184

*Nominal resistance at 20°C.

AWG/Metric Comparison

Stranded Conductors

Cond. Diameter (mm ²)	Stranding x Strand Dia. (mm)	Corresponding AWG	Cond. Diameter (mm ²)	Stranding x Strand Dia. (mm)	Corresponding AWG	Cond. Diameter (mm ²)	Stranding x Strand Dia. (mm)	Corresponding AWG
0.014	7 x 0.05	-	0.283	1 x 0.60	-	1.276	26 x 0.25	16
0.035	7 x 0.08	32	0.291	37 x 0.10	-	1.327	1 x 1.30	16
0.047	24 x 0.05	-	0.314	40 x 0.10	-	1.343	19 x 0.30	16
0.049	1 x 0.25	30	0.322	1 x 0.64	22	1.374	7 x 0.50	16
0.055	7 x 0.10	30	0.336	19 x 0.15	22	1.473	30 x 0.25	-
0.079	10 x 0.10	-	0.344	7 x 0.25	22	1.508	12 x 0.40	-
0.079	7 x 0.12	-	0.377	12 x 0.20	-	1.828	19 x 0.35	14
0.080	1 x 0.32	28	0.377	48 x 0.10	-	1.885	60 x 0.20	-
0.093	7 x 0.13	28	0.389	22 x 0.15	-	1.909	27 x 0.030	-
0.094	12 x 0.10	-	0.442	1 x 0.75	-	1.979	7 x 0.60	-
0.094	48 x 0.05	-	0.459	26 x 0.15	20	2.011	16 x 0.40	-
0.096	19 x 0.08	28	0.491	10 x 0.25	20	2.013	41 x 0.25	14
0.113	10 x 0.12	-	0.495	7 x 0.30	-	2.087	1 x 1.63	14
0.118	60 x 0.05	-	0.503	16 x 0.20	-	2.454	50 x 0.25	14
0.118	15 x 0.10	-	0.515	1 x 0.81	20	3.022	19 x 0.45	12
0.124	7 x 0.15	26	0.563	7 x 0.32	20	3.142	16 x 0.50	-
0.126	1 x 0.40	26	0.597	19 x 0.20	20	3.181	45 x 0.30	-
0.149	19 x 0.10	26	0.636	36 x 0.15	-	3.191	65 x 0.25	12
0.177	10 x 0.15	24	0.754	24 x 0.20	-	3.393	48 x 0.30	-
0.188	24 x 0.10	-	0.785	16 x 0.25	18	3.958	56 x 0.30	-
0.196	1 x 0.50	24	0.817	1 x 1.02	18	4.650	37 x 0.40	-
0.212	27 x 0.10	-	0.848	12 x 0.30	-	4.714	7 x 7 x 0.35	-
0.212	12 x 0.15	-	0.880	7 x 0.40	18	5.154	105 x 0.25	-
0.220	7 x 0.20	24	0.933	19 x 0.25	18	5.160	73 x 0.30	10
0.251	32 x 0.10	-	0.990	56 x 0.15	-	5.300	75 x 0.30	10
0.252	19 x 0.13	24	1.005	32 x 0.20	-			

Conductor Color Coding

Multipair Cables

Chart A

Pair No.	Color Combination	Pair No.	Color Combination	Pair No.	Color Combination	Pair No.	Color Combination
1	Black +Red	14	Green + Blue	27	Brown + Yellow	40	Slate + Blue
2	Black + White	15	Green + White	28	Violet + Red	41	Slate + Brown
3	Black + Green	16	Green + Brown	29	Violet + White	42	Slate + Yellow
4	Black + Blue	17	Green + Orange	30	Violet + Green	43	Slate + Orange
5	Black + Brown	18	Green + Yellow	31	Violet + Blue	44	Slate + Black
6	Black + Yellow	19	White + Blue	32	Violet + Brown	45	White/Black + Red
7	Black + Orange	20	White + Brown	33	Violet + Yellow	46	White/Black + Green
8	Red + Green	21	White + Orange	34	Violet + Orange	47	White/Black + Blue
9	Red + White	22	White + Yellow	35	Violet + Slate	48	White/Black + Brown
10	Red + Blue	23	Blue + Brown	36	Violet + Black	49	White/Black + Yellow
11	Red + Yellow	24	Blue + Orange	37	Slate + Red	50	White/Black + Orange
12	Red + Brown	25	Blue + Yellow	38	Slate + White	51	White/Black + Violet
13	Red + Orange	26	Brown + Orange	39	Slate + Green		

Chart A1

Pair No.	Color Combination	Pair No.	Color Combination	Pair No.	Color Combination	Pair No.	Color Combination
1	Black +Red	14	Green + White	27	Brown + Orange	40	Slate + Blue
2	Black + White	15	Green + Blue	28	Violet + Red	41	Slate + Brown
3	Black + Green	16	Green + Yellow	29	Violet + White	42	Slate + Yellow
4	Black + Blue	17	Green + Brown	30	Violet + Green	43	Slate + Orange
5	Black + Yellow	18	Green + Orange	31	Violet + Blue	44	Slate + Black
6	Black + Brown	19	White + Blue	32	Violet + Brown	45	White/Black + Red
7	Black + Orange	20	White + Yellow	33	Violet + Yellow	46	White/Black + Green
8	Red + White	21	White + Brown	34	Violet + Orange	47	White/Black + Blue
9	Red + Green	22	White + Orange	35	Violet + Slate	48	White/Black + Brown
10	Red + Blue	23	Blue + Yellow	36	Violet + Black	49	White/Black + Yellow
11	Red + Yellow	24	Blue + Brown	37	Slate + Red	50	White/Black + Orange
12	Red + Brown	25	Blue + Orange	38	Slate + White	51	White/Black + Violet
13	Red + Orange	26	Brown + Yellow	39	Slate + Green		

Chart B

Pair No.	Color Combination	Pair No.	Color Combination	Pair No.	Color Combination
1	White +Black	35	Orange +Slate	69	White/Red +Green
2	White +Brown	36	Yellow +Green	70	White/Red +Blue
3	White +Red	37	Yellow +Blue	71	White/Red +Violet
4	White +Orange	38	Yellow +Violet	72	White/Red +Slate
5	White +Yellow	39	Yellow +Slate	73	White/Orange +Black
6	White +Green	40	Green +Blue	74	White/Orange +Brown
7	White +Blue	41	Green +Violet	75	White/Orange +Red
8	White +Violet	42	Green +Slate	76	White/Orange +Orange
9	White +Slate	43	Blue +Violet	77	White/Orange +Yellow
10	Black +Brown	44	Blue +Slate	78	White/Orange +Green
11	Black +Red	45	Violet +Slate	79	White/Orange +Blue
12	Black +Orange	46	White/Black +Black	80	White/Orange +Violet
13	Black +Yellow	47	White/Black +Brown	81	White/Orange +Slate
14	Black +Green	48	White/Black +Red	82	White/Yellow +Black
15	Black +Blue	49	White/Black +Orange	83	White/Yellow +Brown
16	Black +Violet	50	White/Black +Yellow	84	White/Yellow +Red
17	Black +Slate	51	White/Black +Green	85	White/Yellow +Orange
18	Brown +Red	52	White/Black +Blue	86	White/Yellow +Yellow
19	Brown +Orange	53	White/Black +Violet	87	White/Yellow +Green
20	Brown +Yellow	54	White/Black +Slate	88	White/Yellow +Blue
21	Brown +Green	55	White/Brown +Black	89	White/Yellow +Violet
22	Brown +Blue	56	White/Brown +Brown	90	White/Yellow +Slate
23	Brown +Violet	57	White/Brown +Red	91	White/Green +Black
24	Brown +Slate	58	White/Brown +Orange	92	White/Green +Brown
25	Red +Orange	59	White/Brown +Yellow	93	White/Green +Red
26	Red +Yellow	60	White/Brown +Green	94	White/Green +Orange
27	Red +Green	61	White/Brown +Blue	95	White/Green +Yellow
28	Red +Blue	62	White/Brown +Violet	96	White/Green +Green
29	Red +Violet	63	White/Brown +Slate	97	White/Green +Blue
30	Red +Slate	64	White/Red +Black	98	White/Green +Violet
31	Orange +Yellow	65	White/Red +Brown	99	White/Green +Slate
32	Orange +Green	66	White/Red +Red	100	White/Blue +Black
33	Orange +Blue	67	White/Red +Orange	101	White/Blue +Brown
34	Orange +Violet	68	White/Red +Yellow	102	White/Blue +Red

Conductor Color Coding

Multipair Cables

Chart BR							
Pair No.	Color Combination	Pair No.	Color Combination	Pair No.	Color Combination	Pair No.	Color Combination
1	Black #1 + Red #1	14	Black #14 + Red #14	27	Black #27 + Red #27	40	Black #40 + Red #40
2	Black #2 + Red #2	15	Black #15 + Red #15	28	Black #28 + Red #28	41	Black #41 + Red #41
3	Black #3 + Red #3	16	Black #16 + Red #16	29	Black #29 + Red #29	42	Black #42 + Red #42
4	Black #4 + Red #4	17	Black #17 + Red #17	30	Black #30 + Red #30	43	Black #43 + Red #43
5	Black #5 + Red #5	18	Black #18 + Red #18	31	Black #31 + Red #31	44	Black #44 + Red #44
6	Black #6 + Red #6	19	Black #19 + Red #19	32	Black #32 + Red #32	45	Black #45 + Red #45
7	Black #7 + Red #7	20	Black #20 + Red #20	33	Black #33 + Red #33	46	Black #46 + Red #46
8	Black #8 + Red #8	21	Black #21 + Red #21	34	Black #34 + Red #34	47	Black #47 + Red #47
9	Black #9 + Red #9	22	Black #22 + Red #22	35	Black #35 + Red #35	48	Black #48 + Red #48
10	Black #10 + Red #10	23	Black #23 + Red #23	36	Black #36 + Red #36	49	Black #49 + Red #49
11	Black #11 + Red #11	24	Black #24 + Red #24	37	Black #37 + Red #37	50	Black #50 + Red #50
12	Black #12 + Red #12	25	Black #25 + Red #25	38	Black #38 + Red #38	51	Black #51 + Red #51
13	Black #13 + Red #13	26	Black #26 + Red #26	39	Black #39 + Red #39		

Chart BW							
Pair No.	Color Combination	Pair No.	Color Combination	Pair No.	Color Combination	Pair No.	Color Combination
1	Black + White #1	14	Black + White #14	27	Black + White #27	40	Black + White #40
2	Black + White #2	15	Black + White #15	28	Black + White #28	41	Black + White #41
3	Black + White #3	16	Black + White #16	29	Black + White #29	42	Black + White #42
4	Black + White #4	17	Black + White #17	30	Black + White #30	43	Black + White #43
5	Black + White #5	18	Black + White #18	31	Black + White #31	44	Black + White #44
6	Black + White #6	19	Black + White #19	32	Black + White #32	45	Black + White #45
7	Black + White #7	20	Black + White #20	33	Black + White #33	46	Black + White #46
8	Black + White #8	21	Black + White #21	34	Black + White #34	47	Black + White #47
9	Black + White #9	22	Black + White #22	35	Black + White #35	48	Black + White #48
10	Black + White #10	23	Black + White #23	36	Black + White #36	49	Black + White #49
11	Black + White #11	24	Black + White #24	37	Black + White #37	50	Black + White #50
12	Black + White #12	25	Black + White #25	38	Black + White #38		
13	Black + White #13	26	Black + White #26	39	Black + White #39		

Chart C							
Pair No.	Color Combination	Pair No.	Color Combination	Pair No.	Color Combination	Pair No.	Color Combination
1	Blue + White	14	Orange/Slate + White	27	Blue/Orange + Red	40	Slate/White + Red
2	Orange + White	15	Green/White + White	28	Blue/Green + Red	41	Blue + Black
3	Green + White	16	Green/Brown + White	29	Blue/Brown + Red	42	Orange + Black
4	Brown + White	17	Green/Slate + White	30	Blue/Slate + Red	43	Green + Black
5	Slate + White	18	Brown/White + White	31	Orange/White + Red	44	Brown + Black
6	Blue/White + White	19	Brown/Slate + White	32	Orange/Green + Red	45	Slate + Black
7	Blue/Orange + White	20	Slate/White + White	33	Orange/Brown + Red	46	Blue/White + Black
8	Blue/Green + White	21	Blue + Red	34	Orange/Slate + Red	47	Blue/Orange + Black
9	Blue/Brown + White	22	Orange + Red	35	Green/White + Red	48	Blue/Green + Black
10	Blue/Slate + White	23	Green + Red	36	Green/Brown + Red	49	Blue/Brown + Black
11	Orange/White + White	24	Brown + Red	37	Green/Slate + Red	50	Blue/Slate + Black
12	Orange/Green + White	25	Slate + Red	38	Brown/White + Red	51	Orange/White + Black
13	Orange/Brown + White	26	Blue/White + Red	39	Brown/Slate + Red		

Chart K					
Pair No.	Color Combination	Pair No.	Color Combination	Pair No.	Color Combination
1	Black + Red	14	Green + White	27	Brown + Orange
2	Black + White	15	Green + Blue	28	Orange + Yellow
3	Black + Green	16	Green + Yellow	29	Violet + Orange
4	Black + Blue	17	Green + Brown	30	Violet + Red
5	Black + Yellow	18	Green + Orange	31	Violet + White
6	Black + Brown	19	White + Blue	32	Violet + Green
7	Black + Orange	20	White + Yellow	33	Violet + Blue
8	Red + White	21	White + Brown	34	Violet + Yellow
9	Red + Green	22	White + Orange	35	Violet + Brown
10	Red + Blue	23	Blue + Yellow	36	Violet + Black
11	Red + Yellow	24	Blue + Brown	37	Slate + White
12	Red + Brown	25	Blue + Orange		
13	Red + Orange	26	Brown + Yellow		

Conductor Color Coding

Multipair Cables

Chart L

Pair No.	Color Combination	Pair No.	Color Combination
1	White + Blue	10	Red + Slate
2	White + Orange	11	Black + Blue
3	White + Green	12	Black + Orange
4	White + Brown	13	Black + Green
5	White + Slate	14	Black + Brown
6	Red + Blue	15	Black + Slate
7	Red + Orange	16	Yellow + Blue
8	Red + Green	17	Yellow + Orange
9	Red + Brown	18	Yellow + Green
		19	Yellow + Brown
		20	Yellow + Slate
		21	Violet + Blue
		22	Violet + Orange
		23	Violet + Green
		24	Violet + Brown
		25	Violet + Slate

Chart M

Pair No.	Color Combination	Pair No.	Color Combination	Pair No.	Color Combination
1	Blue/White + White/Blue	10	Slate/Red + Red/Slate	19	Brown/Yellow + Yellow/Brown
2	Orange/White + White/Orange	11	Blue/Black + Black/Blue	20	Slate/Yellow + Yellow/Slate
3	Green/White + White/Green	12	Orange/Black + Black/Orange	21	Blue/Violet + Violet/Blue
4	Brown/White + White/Brown	13	Green/Black + Black/Green	22	Orange/Violet + Violet/Orange
5	Slate/White + White/Slate	14	Brown/Black + Black/Brown	23	Green/Violet + Violet/Green
6	Blue/Red + Red/Blue	15	Slate/Black + Black/Slate	24	Brown/Violet + Violet/Brown
7	Orange/Red + Red/Orange	16	Blue/Yellow + Yellow/Blue	25	Slate/Violet + Violet/Slate
8	Green/Red + Red/Green	17	Orange/Yellow + Yellow/Orange		
9	Brown/Red + Red/Brown	18	Green/Yellow + Yellow/Green		

Chart N

Pair No.	Color Combination
1	Black + Yellow
2	Red + Violet
3	Blue + Brown
4	Orange + Green
5	Black/White + White/Black
6	Brown/White + White/Brown
7	Red/White + White/Red
8	Orange/White + White/Orange
9	Yellow/White + White/Yellow
10	Green/White + White/Green
11	Blue/White + White/Blue
12	Violet/White + White/Violet

Chart Q

Pair No.	Color Combination
1	Black + White
2	Red + Green
3	Brown + Blue
4	Orange + Yellow
5	Violet + Slate
6	Tan + Pink
7	White/Blue + Blue/White
8	White/Brown + Brown/White
9	White/Orange + Orange/White
10	White/Green + Green/White
11	White/Red + Red/White
12	White/Black + Black/White
13	Yellow/Blue + Blue/Yellow
14	Yellow/Brown + Brown/Yellow
15	Yellow/Orange + Orange/Yellow
16	Yellow/Red + Red/Yellow
17	Yellow/Black + Black/Yellow
18	Yellow/Violet + Violet/Yellow

Conductor Color Coding

Multiconductor Cables

Chart D													
No.	Base Color	1st Stripe	2nd Stripe	3rd Stripe					No.	Base Color	1st Stripe	2nd Stripe	3rd Stripe
1	Black				35	White	Red	Red	69	White	Black	Green	Blue
2	Red				36	White	Red	Green	70	White	Black	Green	Brown
3	White				37	White	Red	Blue	71	White	Black	Green	Orange
4	Green				38	White	Red	Brown	72	White	Black	Green	Slate
5	Orange				39	White	Red	Violet	73	White	Black	Green	Violet
6	Blue				40	White	Green	Black	74	White	Black	Yellow	Blue
7	Brown				41	White	Green	Red	75	White	Black	Yellow	Brown
8	Yellow				42	White	Green	Green	76	White	Black	Yellow	Orange
9	Violet				43	White	Green	Blue	77	White	Black	Yellow	Slate
10	Slate				44	White	Green	Brown	78	White	Black	Yellow	Violet
11	Pink				45	White	Green	Violet	79	White	Black	Blue	Brown
12	Tan				46	White	Blue	Black	80	White	Black	Blue	Orange
13	Red	Green			47	White	Blue	Red	81	White	Black	Blue	Slate
14	Red	Yellow			48	White	Blue	Green	82	White	Black	Blue	Violet
15	Red	Black			49	White	Blue	Blue	83	White	Black	Brown	Orange
16	White	Black			50	White	Blue	Brown	84	White	Black	Brown	Slate
17	White	Red			51	White	Blue	Violet	85	White	Black	Brown	Violet
18	White	Green			52	White	Brown	Black	86	White	Black	Orange	Slate
19	White	Yellow			53	White	Brown	Red	87	White	Black	Orange	Violet
20	White	Blue			54	White	Brown	Green	88	White	Black	Slate	Violet
21	White	Brown			55	White	Brown	Blue	89	White	Red	Black	Green
22	White	Orange			56	White	Brown	Brown	90	White	Red	Black	Yellow
23	White	Slate			57	White	Brown	Violet	91	White	Red	Black	Blue
24	White	Violet			58	White	Violet	Red	92	White	Red	Black	Brown
25	White	Black	Red		59	White	Violet	Green	93	White	Red	Black	Orange
26	White	Black	Green		60	White	Violet	Blue	94	White	Red	Black	Slate
27	White	Black	Yellow		61	White	Black	Red	95	White	Red	Black	Violet
28	White	Black	Blue		62	White	Black	Red	96	White	Red	Green	Yellow
29	White	Black	Brown		63	White	Black	Red	97	White	Red	Green	Blue
30	White	Black	Orange		64	White	Black	Red	98	White	Red	Green	Brown
31	White	Black	Slate		65	White	Black	Red	99	White	Red	Green	Orange
32	White	Black	Violet		66	White	Black	Red	100	White	Red	Green	Slate
33	White	Black	Black		67	White	Black	Red					
34	White	Red	Black		68	White	Black	Green					

Chart D1	
No.	Color
1	Black
2	Red
3	White
4	Green
5	Yellow
6	Blue

Chart CE	
No.	Color
1	Green/Yellow
2	Lt. Blue
3	Black
4	Brown

Chart D2		
No.	Base Color	Stripe
1	Black	
2	White	
3	Red	
4	Green	
5	Brown	
6	Blue	
7	Orange	
8	Yellow	
9	Violet	
10	Slate	
11	Pink	
12	Tan	
13	White	Blue

No.	Base Color	Stripe
14	White	Orange
15	White	Green
16	White	Brown
17	White	Slate
18	Red	Blue
19	Red	Orange
20	Red	Green
21	Red	Brown
22	Red	Slate
23	Green	Blue
24	Green	Orange
25	Green	Brown

Conductor Color Coding

Multiconductor Cables

Chart E														
No.	Base Color	1st Stripe	2nd Stripe	3rd Stripe	No.	Base Color	1st Stripe	2nd Stripe	3rd Stripe	No.	Base Color	1st Stripe	2nd Stripe	3rd Stripe
1	Black				35	White	Red	Orange		69	White	Black	Orange	Green
2	Brown				36	White	Red	Yellow		70	White	Black	Orange	Blue
3	Red				37	White	Red	Green		71	White	Black	Orange	Violet
4	Orange				38	White	Red	Blue		72	White	Black	Orange	Slate
5	Yellow				39	White	Red	Violet		73	White	Black	Yellow	Green
6	Green				40	White	Red	Slate		74	White	Black	Yellow	Blue
7	Blue				41	White	Orange	Yellow		75	White	Black	Yellow	Violet
8	Violet				42	White	Orange	Green		76	White	Black	Yellow	Slate
9	Slate				43	White	Orange	Blue		77	White	Black	Green	Blue
10	White				44	White	Orange	Violet		78	White	Black	Green	Violet
11	White	Black			45	White	Orange	Slate		79	White	Black	Green	Slate
12	White	Brown			46	White	Yellow	Green		80	White	Black	Blue	Violet
13	White	Red			47	White	Yellow	Blue		81	White	Black	Blue	Slate
14	White	Orange			48	White	Yellow	Violet		82	White	Black	Violet	Slate
15	White	Yellow			49	White	Yellow	Slate		83	White	Brown	Red	Orange
16	White	Green			50	White	Green	Blue		84	White	Brown	Red	Yellow
17	White	Blue			51	White	Green	Violet		85	White	Brown	Red	Green
18	White	Violet			52	White	Green	Slate		86	White	Brown	Red	Blue
19	White	Slate			53	White	Blue	Violet		87	White	Brown	Red	Violet
20	White	Black	Brown		54	White	Blue	Slate		88	White	Brown	Red	Slate
21	White	Black	Red		55	White	Violet	Slate		89	White	Brown	Orange	Yellow
22	White	Black	Orange		56	White	Black	Brown	Red	90	White	Brown	Orange	Green
23	White	Black	Yellow		57	White	Black	Brown	Orange	91	White	Brown	Orange	Blue
24	White	Black	Green		58	White	Black	Brown	Yellow	92	White	Brown	Orange	Violet
25	White	Black	Blue		59	White	Black	Brown	Green	93	White	Brown	Orange	Slate
26	White	Black	Violet		60	White	Black	Brown	Blue	94	White	Brown	Yellow	Green
27	White	Black	Slate		61	White	Black	Brown	Violet	95	White	Brown	Yellow	Blue
28	White	Brown	Red		62	White	Black	Brown	Slate	96	White	Brown	Yellow	Violet
29	White	Brown	Orange		63	White	Black	Red	Yellow	97	White	Brown	Yellow	Slate
30	White	Brown	Yellow		64	White	Black	Red	Green	98	White	Brown	Green	Blue
31	White	Brown	Green		65	White	Black	Red	Blue	99	White	Brown	Green	Violet
32	White	Brown	Blue		66	White	Black	Red	Violet	100	White	Brown	Green	Slate
33	White	Brown	Violet		67	White	Black	Red	Slate					
34	White	Brown	Slate		68	White	Black	Orange	Yellow					

Chart F											
No.	Base Color	1st Stripe	2nd Stripe	No.	Base Color	1st Stripe	2nd Stripe	No.	Base Color	1st Stripe	2nd Stripe
1	Black			21	Orange	Green		41	Green	White	Blue
2	White			22	Black	White	Red	42	Orange	Red	Green
3	Red			23	White	Black	Red	43	Blue	Red	Green
4	Green			24	Red	Black	White	44	Black	White	Blue
5	Orange			25	Green	Black	White	45	White	Black	Blue
6	Blue			26	Orange	Black	White	46	Red	White	Blue
7	White	Black		27	Blue	Black	White	47	Green	Orange	Red
8	Red	Black		28	Black	Red	Green	48	Orange	Red	Blue
9	Green	Black		29	White	Red	Green	49	Blue	Red	Orange
10	Orange	Black		30	Red	Black	Green	50	Black	Orange	Red
11	Blue	Black		31	Green	Black	Orange	51	White	Black	Orange
12	Black	White		32	Orange	Black	Green	52	Red	Orange	Black
13	Red	White		33	Blue	White	Orange	53	Green	Red	Blue
14	Green	White		34	Black	White	Orange	54	Orange	Black	Blue
15	Blue	White		35	White	Red	Orange	55	Blue	Black	Orange
16	Black	Red		36	Orange	White	Blue	56	Black	Orange	Green
17	White	Red		37	White	Red	Blue	57	White	Orange	Green
18	Orange	Red		38	Black	White	Green	58	Red	Orange	Green
19	Blue	Red		39	White	Black	Green	59	Green	Black	Blue
20	Red	Green		40	Red	White	Green	60	Orange	Green	Blue

Chart G								
No.	Base Color	Stripe	No.	Base Color	Stripe	No.	Base Color	Stripe
1	White		6	Blue		11	White	Black
2	Black		7	Brown		12	White	Brown
3	Red		8	Orange		13	White	Red
4	Green		9	Slate		14	White	Orange
5	Yellow		10	Violet		15	White	Yellow

Conductor Color Coding

Multiconductor Cables

Chart H								
No.	Base Color	Stripe	No.	Base Color	Stripe	No.	Base Color	Stripe
1	Black		8	Orange		15	White	Blue
2	White		9	Slate		16	White	Brown
3	Red		10	Violet		17	White	Violet
4	Green		11	White	Black	18	White	Slate
5	Yellow		12	White	Red	19	Black	Red
6	Blue		13	White	Green	20	Black	Yellow
7	Brown		14	White	Yellow			

Chart I		
No.	Color	
1	Green	
2	White	
3	Brown	
4	Blue	
5	Orange	
6	Yellow	

Chart J					
No.	Base Color	Stripe	No.	Base Color	Stripe
1	Black		20	Yellow	Blue
2	Red		21	Brown	Blue
3	Blue		22	Black	Orange
4	Orange		23	Red	Orange
5	Yellow		24	Blue	Orange
6	Brown		25	Yellow	Orange
7	Red	Black	26	Brown	Orange
8	Blue	Black	27	Black	Yellow
9	Orange	Black	28	Red	Yellow
10	Yellow	Black	29	Blue	Yellow
11	Brown	Black	30	Orange	Yellow
12	Black	Red	31	Brown	Yellow
13	Blue	Red	32	Black	Brown
14	Orange	Red	33	Red	Brown
15	Yellow	Red	34	Blue	Brown
16	Brown	Red	35	Orange	Brown
17	Black	Blue	36	Yellow	Brown
18	Red	Blue	37	Black	
19	Orange	Blue			

Chart I2		
No.	Color	Stripe
1	Brown	
2	Blue	
3	Green	Yellow

Chart J1		
No.	Base Color	Stripe
1	Black #1	
2	Red #2	
3	Blue #3	
4	Orange #4	
5	Yellow #5	
6	Brown #6	
7	Red	Black #7
8	Blue	Black #8
9	Orange	Black #9
10	Yellow	Black #10
11	Brown	Black #11
12	Black	Red #12

Chart KW			
No.	Color	No.	Color
1	Green/Yellow	34	Black #33
2	Black #1	35	Black #34
3	White/Black*	36	Black #35
4	Black #3	37	Black #36
5	Black #4	38	Black #37
6	Black #5	39	Black #38
7	Black #6	40	Black #39
8	Black #7	41	Black #40
9	Black #8	42	Black #41
10	Black #9	43	Black #42
11	Black #10	44	Black #43
12	Black #11	45	Black #44
13	Black #12	46	Black #45
14	Black #13	47	Black #46
15	Black #14	48	Black #47
16	Black #15	49	Black #48
17	Black #16	50	Black #49
18	Black #17	51	Black #50
19	Black #18	52	Black #51
20	Black #19	53	Black #52
21	Black #20	54	Black #53
22	Black #21	55	Black #54
23	Black #22	56	Black #55
24	Black #23	57	Black #56
25	Black #24	58	Black #57
26	Black #25	59	Black #58
27	Black #26	60	Black #59
28	Black #27	61	Black #60
29	Black #28	62	Black #61
30	Black #29	63	Black #62
31	Black #30	64	Black #63
32	Black #31	65	Black #64
33	Black #32		

*The white/black neutral conductor is used only on 18 and 16 AWG cables with conductor counts of 12 or greater.

Conductor Color Coding

Multiconductor Cables

Chart KX					
No.	Color			No.	Color
1	Green/Yellow	23	Black #22	45	Black #44
2	Black #1	24	Black #23	46	Black #45
3	Black #2	25	Black #24	47	Black #46
4	Black #3	26	Black #25	48	Black #47
5	Black #4	27	Black #26	49	Black #48
6	Black #5	28	Black #27	50	Black #49
7	Black #6	29	Black #28	51	Black #50
8	Black #7	30	Black #29	52	Black #51
9	Black #8	31	Black #30	53	Black #52
10	Black #9	32	Black #31	54	Black #53
11	Black #10	33	Black #32	55	Black #54
12	Black #11	34	Black #33	56	Black #55
13	Black #12	35	Black #34	57	Black #56
14	Black #13	36	Black #35	58	Black #57
15	Black #14	37	Black #36	59	Black #58
16	Black #15	38	Black #37	60	Black #59
17	Black #16	39	Black #38	61	Black #60
18	Black #17	40	Black #39	62	Black #61
19	Black #18	41	Black #40	63	Black #62
20	Black #19	42	Black #41	64	Black #63
21	Black #20	43	Black #42	65	Black #64
22	Black #21	44	Black #43		

Chart LW					
No.	Color	No.	Color	No.	Color
1	Green/Yellow	23	Dk. Blue #22	45	Dk. Blue #44
2	Dk. Blue #1	24	Dk. Blue #23	46	Dk. Blue #45
3	White/Blue*	25	Dk. Blue #24	47	Dk. Blue #46
4	Dk. Blue #3	26	Dk. Blue #25	48	Dk. Blue #47
5	Dk. Blue #4	27	Dk. Blue #26	49	Dk. Blue #48
6	Dk. Blue #5	28	Dk. Blue #27	50	Dk. Blue #49
7	Dk. Blue #6	29	Dk. Blue #28	51	Dk. Blue #50
8	Dk. Blue #7	30	Dk. Blue #29	52	Dk. Blue #51
9	Dk. Blue #8	31	Dk. Blue #30	53	Dk. Blue #52
10	Dk. Blue #9	32	Dk. Blue #31	54	Dk. Blue #53
11	Dk. Blue #10	33	Dk. Blue #32	55	Dk. Blue #54
12	Dk. Blue #11	34	Dk. Blue #33	56	Dk. Blue #55
13	Dk. Blue #12	35	Dk. Blue #34	57	Dk. Blue #56
14	Dk. Blue #13	36	Dk. Blue #35	58	Dk. Blue #57
15	Dk. Blue #14	37	Dk. Blue #36	59	Dk. Blue #58
16	Dk. Blue #15	38	Dk. Blue #37	60	Dk. Blue #59
17	Dk. Blue #16	39	Dk. Blue #38	61	Dk. Blue #60
18	Dk. Blue #17	40	Dk. Blue #39	62	Dk. Blue #61
19	Dk. Blue #18	41	Dk. Blue #40	63	Dk. Blue #62
20	Dk. Blue #19	42	Dk. Blue #41	64	Dk. Blue #63
21	Dk. Blue #20	43	Dk. Blue #42	65	Dk. Blue #64
22	Dk. Blue #21	44	Dk. Blue #43		

*The white/blue neutral conductor is used only on 18 and 16 AWG cables with conductor counts of 12 or greater.

Chart LX	
No.	Color
1	Green/Yellow
2	Dk. Blue #1
3	Dk. Blue #2
4	Dk. Blue #3
5	Dk. Blue #4
6	Dk. Blue #5
7	Dk. Blue #6
8	Dk. Blue #7
9	Dk. Blue #8
10	Dk. Blue #9
11	Dk. Blue #10

Chart O			
No.	Color	No.	Color
1	Black	9	Violet
2	White	10	Slate
3	Red	11	Pink
4	Green	12	Tan
5	Brown	13	Black/White
6	Blue	14	Red/White
7	Orange	15	Green/White
8	Yellow		

Conductor Color Coding

Chart P	
No.	Color
1	White
2	Black
3	Red
4	Green
5	Blue
6	Brown
7	Yellow
8	Orange

Chart R						
No.	Base Color	1st Stripe	2nd Stripe			
1	Black			16	White	Black
2	Red			17	White	Red
3	Green			18	White	Green
4	White			19	White	Yellow
5	Brown			20	White	Blue
6	Blue			21	White	Brown
7	Orange			22	White	Orange
8	Yellow			23	White	Slate
9	Violet			24	White	Violet
10	Slate			25	White	Black
11	Pink			26	White	Black
12	Tan			27	White	Black
13	Red	Green		28	White	Black
14	Red	Yellow		29	White	Black
15	Red	Black		30	White	Black
						Red
						Green
						Yellow
						Blue
						Brown
						Orange

Chart RW					
No.	Color	No.	Color	No.	Color
1	Green/Yellow	23	Red #22	45	Red #44
2	Red #1	24	Red #23	46	Red #45
3	White/Red*	25	Red #24	47	Red #46
4	Red #3	26	Red #25	48	Red #47
5	Red #4	27	Red #26	49	Red #48
6	Red #5	28	Red #27	50	Red #49
7	Red #6	29	Red #28	51	Red #50
8	Red #7	30	Red #29	52	Red #51
9	Red #8	31	Red #30	53	Red #52
10	Red #9	32	Red #31	54	Red #53
11	Red #10	33	Red #32	55	Red #54
12	Red #11	34	Red #33	56	Red #55
13	Red #12	35	Red #34	57	Red #56
14	Red #13	36	Red #35	58	Red #57
15	Red #14	37	Red #36	59	Red #58
16	Red #15	38	Red #37	60	Red #59
17	Red #16	39	Red #38	61	Red #60
18	Red #17	40	Red #39	62	Red #61
19	Red #18	41	Red #40	63	Red #62
20	Red #19	42	Red #41	64	Red #63
21	Red #20	43	Red #42	65	Red #64
22	Red #21	44	Red #43		

*The white/red neutral conductor is used only on 18 and 16 AWG cables with conductor counts of 12 or greater.

Chart RX	
1	Green/Yellow
2	Red #1
3	Red #2
4	Red #3
5	Red #4
6	Red #5
7	Red #6
8	Red #7
9	Red #8
10	Red #9
11	Red #10
12	Red #11

Conductor Color Coding

Hook-Up Wire

Chart Z1	
No.	Color
1	White
2	Black
3	Red
4	Green
5	Yellow
6	Blue
7	Brown
8	Orange
9	Slate
10	Violet
11	White/Black
12	White/Red
13	White/Green
14	White/Yellow
15	White/Blue
16	White/Brown
17	White/Orange
18	White/Slate
19	White/Violet
28	Green/Yellow
29	Yellow/Green
30	Pink

Chart Z2	
No.	Colors
0	Black
1	Brown
2	Red
3	Orange
4	Yellow
5	Green
6	Blue
7	Violet
8	Slate
9	White
45	Yellow/Green
54	Green/Yellow
90	White/Black
91	White/Brown
92	White/Red
93	White/Orange
94	White/Yellow
95	White/Green
96	White/Blue
97	White/Violet
98	White/Slate
P	Pink
T	Tan
X	Clear

Properties of Common Insulation and Jacket Materials

Plastics									
Property	Low-Density PE	High-Density PE	Cellular PE	Nylon	PP	Cellular PP	PVC	Plenum PVC	PUR
Abrasion Resistance	G	E	F	E	F-G	F-G	F-G	F-G	O
Acid Resistance	G-E	E	G-E	P-F	E	E	G-E	G	F
Alcohol Resistance	E	E	E	P	E	E	P-F	G	P-G
Aliphatic Hydrocarbons Resistance (Gasoline, Kerosene, etc.)	G-E	G-E	G	G	P-F	P	P	P	P-G
Alkali Resistance	G-E	E	G-E	E	E	E	G-E	G	F
Aromatic Hydrocarbons Resistance (Benzol, Toluol, etc.)	P	P	P	G	P-F	P	P-F	P-F	P-G
Electrical Properties	E	E	E	P	E	E	F-G	G	P
Flame Resistance	P	P	P	P	P	P	E	E	P
Halogenated Hydrocarbons Resistance (Degreaser Solvents)	G	G	G	G	P	P	P-F	P-F	P-G
Heat Resistance	G	E	G	E	E	E	G-E	G-E	G
Low-Temperature Flexibility	E	E	E	G	P	P	P-G	P-G	G
Nuclear Radiation Resistance	G-E	G-E	G	F-G	F	F	F	F	G
Oil Resistance	G-E	G-E	G	E	F	F	F	F	E
Oxidation Resistance	E	E	E	E	E	E	E	E	E
Ozone Resistance	E	E	E	E	E	E	E	E	E
Underground Burial	G	E	N/A	P	N/A	N/A	P-G	P	G
Water Resistance	E	E	E	P-F	E	E	F-G	F	P-G
Weather, Sun Resistance	E	E	E	E	E	E	G-E	G	G

Ratings based on average performance of general-purpose compounds. Specific properties can usually be improved by selective compounding.

P Poor
F Fair
G Good
E Excellent
O Outstanding

Fluoropolymers							
Property	FEP	PTFE	ETFE	ECTFE	PVDF	TPE	
Abrasion Resistance	E	O	E	E	E	F-G	
Acid Resistance	E	E	E	E	G-E	G	
Alcohol Resistance	E	E	E	E	E	G	
Aliphatic Hydrocarbons Resistance (Gasoline, Kerosene, etc.)	E	E	E	E	E	P	
Alkali Resistance	E	E	E	E	E	G-E	
Aromatic Hydrocarbons Resistance (Benzol, Toluol, etc.)	E	E	E	E	G-E	P	
Electrical Properties	E	E	E	E	G-E	E	
Flame Resistance	O	E	G	E-O	E	F-G	
Halogenated Hydrocarbons Resistance (Degreaser Solvents)	E	E	E	E	G		
Heat Resistance	O	O	E	O	O	E	
Low-Temperature Flexibility	O	O	E	O	F	E	
Nuclear Radiation Resistance	P-G	P	E	E	E	G	
Oil Resistance	O	E-O	E	O	E	G	
Oxidation Resistance	O	O	E	O	O	E	
Ozone Resistance	E	O	E	E	E	E	
Underground Burial	E	E	E	E	E	P	
Water Resistance	E	E	E	E	E	G-E	
Weather, Sun Resistance	O	O	E	O	E-O	E	

Ratings based on average performance of general-purpose compounds. Specific properties can usually be improved by selective compounding.

P Poor
F Fair
G Good
E Excellent
O Outstanding

Properties of Common Insulation and Jacket Materials

Property	Rubber			
	Rubber	Neoprene	EPDM	Silicone
Abrasion Resistance	E	G-E	G	P
Acid Resistance	F-G	G	G-E	F-G
Alcohol Resistance	G	F	P	G
Aliphatic Hydrocarbons Resistance (Gasoline, Kerosene, etc.)	P	G	P	P-F
Alkali Resistance	F-G	G	G-E	F-G
Aromatic Hydrocarbons Resistance (Benzol, Toluol, etc.)	P	P-F	F	P
Electrical Properties	G	P	E	G
Flame Resistance	P	G	P	F-G
Halogenated Hydrocarbons Resistance (Degreaser Solvents)	P	P	P	P-G
Heat Resistance	F	G	E	O
Low-Temperature Flexibility	G	F-G	G-E	O
Nuclear Radiation Resistance	F	F-G	G	E
Oil Resistance	P	G	P	F-G
Oxidation Resistance	F	G	E	E
Ozone Resistance	P	G	E	O
Water Resistance	G	E	G-E	G-E
Weather, Sun Resistance	F	G	E	O

Ratings based on average performance of general-purpose compounds. Specific properties can usually be improved by selective compounding.

- P** Poor
- F** Fair
- G** Good
- E** Excellent
- O** Outstanding

Temperature Ranges of Insulation and Jacket Materials				
Material	Normal Low	Normal High	Special Low	Special High
ECTFE	-70°C	150°C	—	—
EPDM	-55°C	105°C	—	150°C
ETFE	-65°C	150°C	—	—
FEP	-70°C	200°C	—	—
Neoprene	-20°C	60°C	-55°C	90°C
PE	-60°C	80°C	—	—
Plenum PVC	-20°C	75°C	—	—
PP	-40°C	105°C	—	—
PTFE	-70°C	260°C	—	—
PVC	-20°C	80°C	-55°C	105°C
PVDF	-20°C	125°C	-40°C	150°/150°C
Rubber	-30°C	60°C	-55°C	75°C
Silicone	-80°C	150°C	—	200°C
TPE	-40°C	105°C	-50°C	125°C

Current Ratings for Alpha Cables

The maximum continuous current rating for a cable is limited by conductor size, number of conductors contained within the cable, maximum temperature rating of the cable, and environmental conditions such as ambient temperature and air flow. To use the current capacity chart, first determine conductor size, temperature rating, and number of conductors from the applicable product description for the cable of interest.

Next, find the current value on the chart for the proper temperature rating and conductor size. To calculate the maximum current rating/conductor, multiply the chart value by the appropriate conductor factor.

The chart assumes cable is surrounded by still air at an ambient temperature of 25°C. Current values are in RMS amperes and are valid for copper conductors only. For conditions other than specified, contact Alpha Technical Support at 1-800-52-ALPHA.

Note: Current ratings are intended as general guidelines for low-power electronic communications and control applications. Current ratings for power applications generally are set by regulatory agencies such as UL, CSA, NEC, and others.

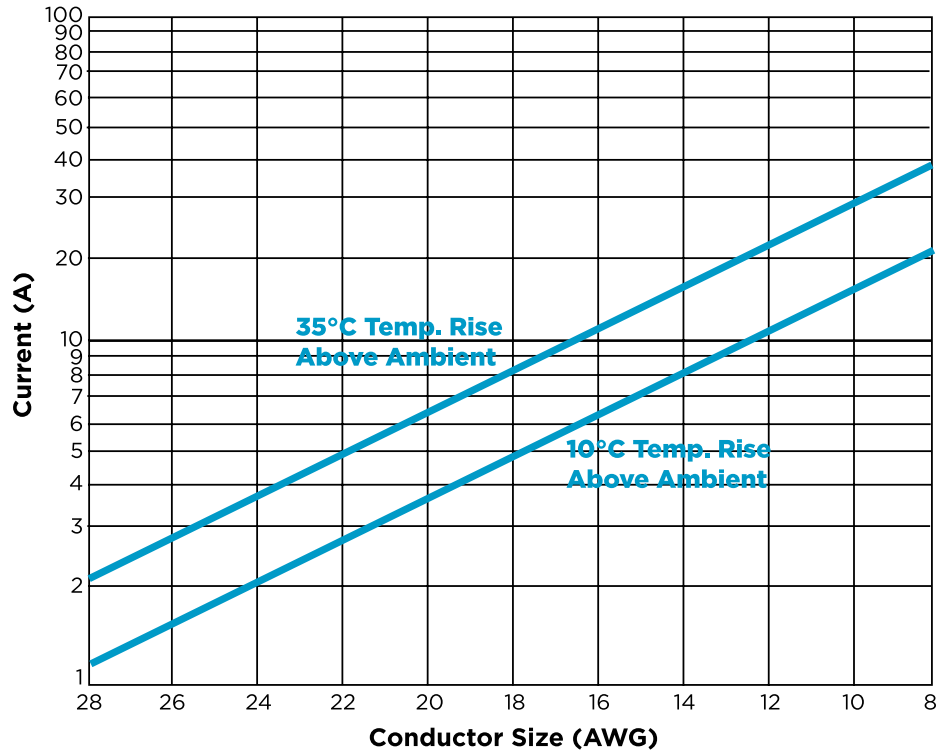

Current Ratings	
No. of Conductors*	Factor
1	1.6
2 to 3	1.0
4 to 5	0.8
6 to 15	0.7
16 to 30	0.5

*Do not count shields unless used as conductor.

Signal Interference

When a particular installation is prone to EMI/RFI/ESI interference from either internal or external sources, some form of cable shielding will be required. The types of interference—or noise—cables are exposed to can determine the type of cable shielding required. There are basically four types of noise which will affect the wiring or cabling of an instrument or control circuit: static, magnetic, common mode, and crosstalk noise.

Static Noise

This refers to signal distortion due to the electrical field radiated by a voltage source, which has coupled into the signal-bearing circuit. Simple shielding of the full circuit is a typical means of mitigating this electrostatic type of interference. Foil shields, which offer 100% shielding efficiency, have proven most effective against this type of interference. It is critical that the shield be continued to, and completely encompass, the transmitting and receiving ends of the circuit if high levels of noise reduction are required. Effective grounding of the shield is also required; “floating” or non-grounded shields only partially reduce the effects of noise.

Magnetic Noise

Magnetic fields, radiated by power wiring found in large AC motors, transformers and knife switches, can set up current flows in opposition to the instrument circuit field. The result is the superimposing of a noise current on the signal current. The simplest and best means of mitigating the effects of such magnetic interference is by simple twisting of the cable elements.

Common Mode Noise

Common mode interference is the result of currents flowing between different potential grounds located at various points within a system. Receivers with very high common mode rejection ratios minimize this type of interference.

Crosstalk

This refers to the superimposing of either pulsed DC or standard AC signals carried on one wire pair to another wire pair in close proximity. Although pair twist tends to reduce crosstalk levels, the most effective means of mitigation is individual cable pair shielding coupled to pair twist.

Noise Levels

Once it has been determined that noise currents are going to pose a system problem, it becomes necessary to determine if the noise is of a low, medium or high level. The table below gives general guidelines as to the areas which are subject to these generalized noise levels:

Noise Level Chart

Noise Level Sources	Noise Sources	Typical Locations
High	Electrolytic processes Large motors, generators, transformers Induction heating Relay controls Power Lines	Heavy processing plants such as steel mills and foundries
Medium	Medium-size motors, generators, transformers Relay controls	Average manufacturing plants
Low	Small motors, generators, transformers	Storage areas, labs, offices and light assembly operations

Shielding

Shielding Performance

The shielding of electronic interconnect cables can play a critical role in overall system performance. System configuration, type of signals transmitted and proximity to noise generating sources all must be considered. These factors plus the type of interference, whether electromagnetic, electrostatic discharge (ESD) or radio frequency, will determine the necessity and type of shielding required. Alpha's Xtra-Guard cables are available in two shielded constructions providing protection for the majority of installation needs.

Shield Coverage: Braided Shield

The effectiveness of a braided shield depends upon the percent coverage afforded by the shield. Leakage in a braided shield is due to air spaces which exist between the weave. The following equation can be used to determine the percent coverage of a braided shield.

$$\tan a = \frac{2\pi (D + 2d)P}{C}$$

where

- C = Number of carriers
- D = Diameter under shield, inches
- d = Diameter of one strand, inches
- P = Picks per inch
- a = Shield angle, degrees
- K = Percent coverage, where

$$K = (2F - F^2) \times 100$$

and

$$F = \frac{NdP}{\sin a}$$

N = Number of strands per carrier

Shield Resistance

The D.C. resistance for braided shields can be calculated using the following equation:

$$R = \frac{dR}{\cos a (NC)}$$

where

R = D.C. resistance, ohms/unit length

dR = D.C. resistance of 1 strand end, ohms/unit length

N = Number of strand ends in one carrier

C = Number of carriers

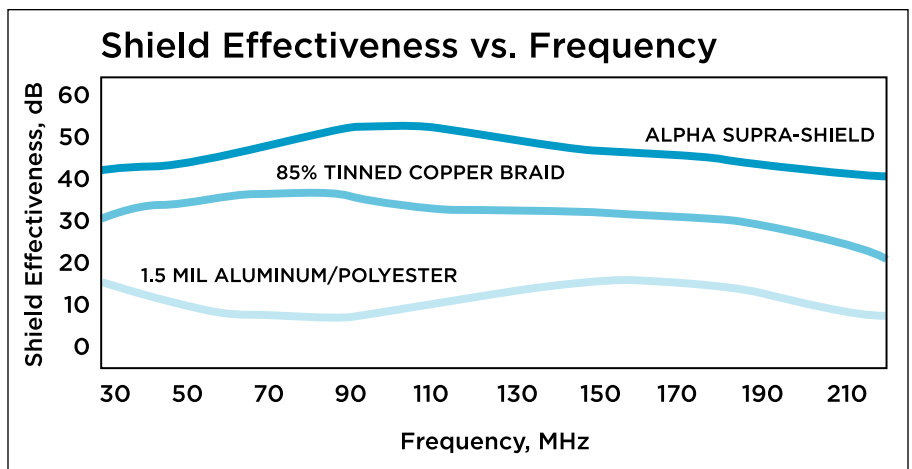
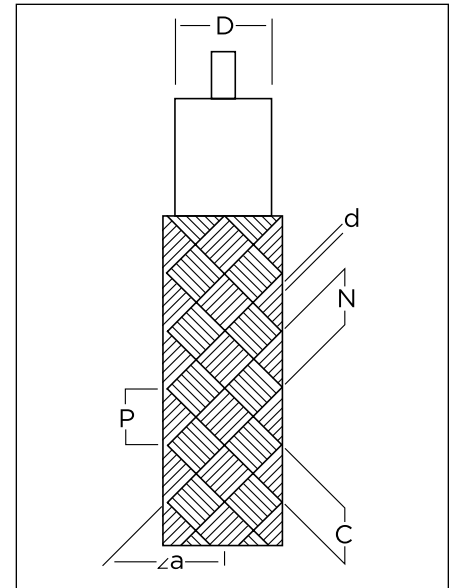

Xtra-Guard Shielding Options

Alpha Aluminum/Polyester Foil Shielding

- Lightweight shielding
- Low cost
- Ease of termination with use of stranded tinned copper drain wire
- High-frequency interference
- 100% coverage over the core of cable conductors

Alpha aluminum/polyester foil shielding consists of an aluminum polyester tape, foil side facing inward, with a 25% overlap and in contact with a stranded, tinned copper drain wire equal in size to insulated cable conductors.

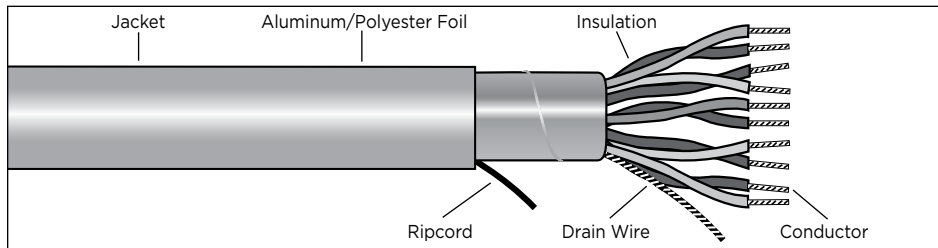

Alpha Supra-Shield® (Foil/Braid) Shielding

- Ease of termination with use of stranded tinned copper drain wire
- High-frequency interference
- High physical strength

Alpha Supra-Shield® (foil/braid) shielding system consists of a unique triple-laminate tape. An aluminum/polyester/aluminum tape is bonded in one layer with a 25% overlap and in contact with a stranded tinned copper drain wire equal in size to the insulated cable conductors. A 70% coverage tinned copper braid shield is applied overall.

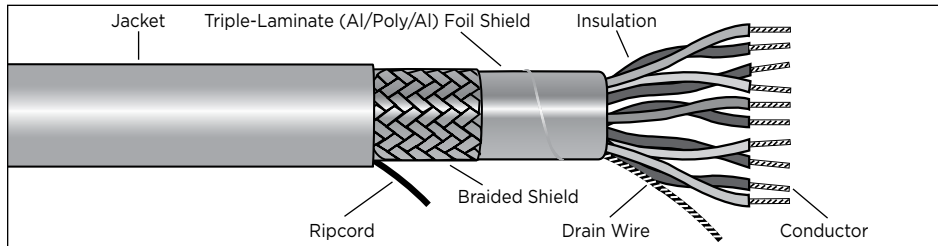

Xtra-Guard Flexible Cable Braid Shielding

- EMI/RFI resistance in power, control and data applications
- Continuous shield continuity in flexing applications
- High physical strength

Xtra-Guard flexible cables have specific shielding requirements resulting from the stresses of motion and flexing. Where foil shields will tear and lose continuity, Xtra-Guard flexible cables use a flexible, 85% coverage, tinned copper braid with a double jacket isolating the shield from the cable's inner core.

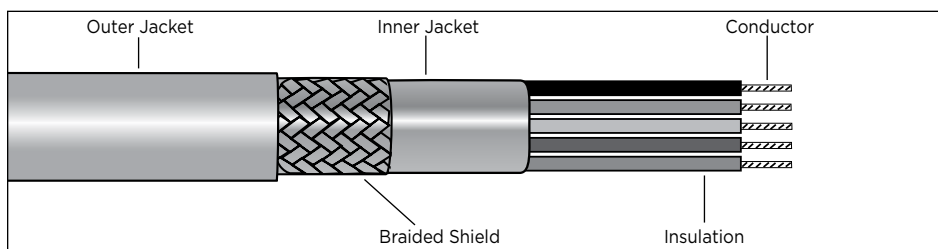

Common Flexing Applications

In applying a cable to a flexing application, you must consider the four types of flexing that may be encountered: Rolling Flex, Bending or Tic-Toc Flex, Torsional Flex, and Variable/Random Flex.

Rolling Flex

Rolling flex applications include linear motion associated with cable track systems or single axis slide apparatus. The most common type of rolling flex includes cable track systems where the cables are “managed” within an enclosed rolling motion carrier.

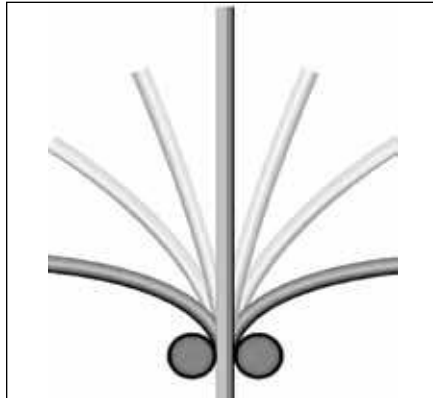
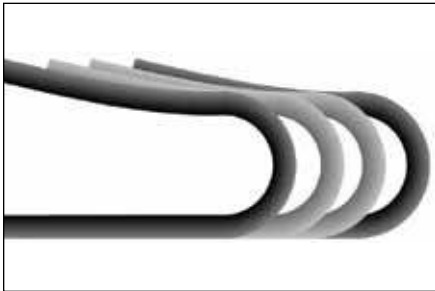

bending moment of the cable is subjected to stress and fatigue from lateral motion in these applications.

Torsional Flex

Torsional flexing applications occur when the cable is subjected to twisting forces, usually in a circular motion around the central axis of the cable. Robotic and pick/place apparatus are the most common applications subjecting cables to torsional stress.

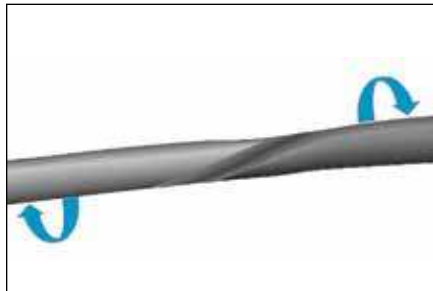

Variable Flex

Variable flexing applications are random applications, which may occur in any number of flexing environments. Examples include articulation found in robotics, automated equipment, and hand-held devices.

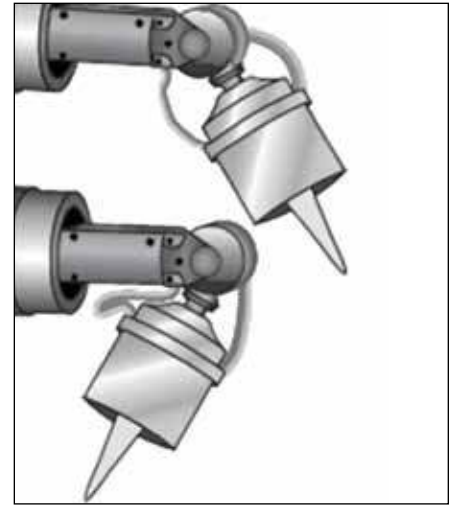

Alpha Wire offers flexible cables products designed specifically for each of these types of flexure. In addition, Alpha’s engineering staff can assist the user in the design of application specific cables to suit specific needs, or in the specification of an existing Alpha Wire product. A close examination of the flex requirements is an important first step in selecting product.

Bending Flex

Bending or tick toc flex occurs when a cable is subjected to repetitive motion at a fixed point in the axis of the cable. The

Technical Data

Cable Flex Test Capabilities Matrix							
Flex Test Type	Applicable Standard	Travel Speed Or Cyclic Rate	Length Of Travel	Test Specimen	Bend Radius Or Mandrel Diameter	Sample Population	Acceptance Criteria
Rolling	Cable Track Alpha Rolling Flex	12.5 ft/s; 17 Cycles Per Minute	14 ft	28 ft	4.5" to 6.69"	1 Test Specimen Per Construction	Cycles to Failure
Bending/ Tic-Toc	MIL-C-13777G Section 3.7.2 and Section 4.5.4.1	30 Cycles Per Minute	42"@ ±90 degrees	42"	3/8" to 5/8"	3 Test Specimens Per Construction	Pass/Fail @ 1000 Cycles
Torsional	MIL-C-13777G Section 3.7.2 and Section 4.5.4.1	30 Cycles Per Minute	22"@ ±90 degrees	66"	3", 4.5", 6", 9"	3 Test Specimens Per Construction	Pass/Fail @ 3000 Cycles

Common Flexing Applications

Cable Family	Part No./Cable Description	Shield	Bend Radius	Cable Diameter	Bend Ratio: Radius/Diameter	Failure	Cycle Count	Test Status
Xtra-Guard Continuous Flex Control	85025 20 AWG x 25 Conductors	No	6.69	0.77	8.69:1	No	13,800,000	Complete
Xtra-Guard Continuous Flex Control	85807CY 18AWG x 7 Conductors	Yes	6.69	0.61	10.97:1	No	13,800,000	Test Complete
Xtra-Guard Continuous Flex Control	85618 16AWG x 18 Conductors	No	6.69	0.78	8.58:1	No	13,800,000	Test Complete
Xtra-Guard Continuous Flex Control	85404CY 14AWG x 4 Conductors	Yes	6.69	0.64	10.45:1	No	13,800,000	Test Complete
Xtra-Guard Continuous Flex Data	86714CY 22 AWG x 7 Pairs	Yes	4.5	0.51	8.82:1	No	14,500,000	Complete
Xtra-Guard Continuous Flex Data	86325CY 22 AWG x 25 Conductors	Yes	4.5	0.41	10.98:1	No	6,700,000	Complete
Series F	F16017RW 16 AWG x 17 Conductors	No	6.69	0.67	9.99:1	No	5,698,000	Complete
Series F	F16025RW 16 AWG x 25 Conductors	No	6.69	0.79	8.47:1	No	5,698,000	Complete
Series F	F16022RW 16 AWG x 22 Conductors	No	6.69	0.73	9.16:1	No	5,698,000	Complete
Series F	F16012RW 16 AWG x 12 Conductors	No	4.5	0.58	7.76:1	No	7,000,000	Complete
Series F	F16033RW 16 AWG x 33 Conductors	No	6.69	0.89	7.52:1	No	7,000,000	Complete
Series F	F16017RW 16 AWG x 17 Conductors	No	6.69	0.67	9.99:1	No	3,000,000	Complete
Series F	F16033RW 16 AWG x 33 Conductors	No	6.69	0.89	7.52:1	No	3,000,000	Complete
Series F	F16022RW 16 AWG x 22 Conductors	No	6.69	0.73	9.16:1	No	3,000,000	3,000,000
Series F	F08004KW 8 AWG x 4 Conductors	No	6.69	0.74	9.04:1	No	7,500,000	Track Failed
Series M	M16122RW 16 AWG x 22 Conductors	No	4.5	0.58	7.76:1	No	1,594,000	Complete
Series M	M16133RW 16 AWG x 33 Conductors	No	4.5	0.89	5.06:1	Yes	1,594,000	Complete

Agency Approvals

UL/NEC • cUL/CEC • CSA/CEC Classification

UL Standard 444/CSA C22.2: Multi-National Harmonized Communication Cable Standards CSA C22.2 No. 214-94 and UL 444.

UL (Underwriters Laboratories Inc.): Develops standards and test procedures for products, materials, components, assemblies, tool, and equipment. It mainly deals with product safety in the United States.

NEC (National Electrical Code): A United States standard for the safe installation of electrical wiring equipment.

AWM (Appliance Wiring Material): Intended for the internal wiring of factory-assembled products.

CSA (Canadian Standards Association International): Tests products for compliant to national and international standards and issues certification marks for qualified products

CEC (Canadian Electrical Code): A standard published by the CSA that pertains to the installation and maintenance of electrical equipment in Canada.

cUL: A notation indicating the UL has listed the product under the applicable CSA standard.

cRU: A notation indicating the UL has recognized the product under the applicable CSA standard.

CE (Conformité Européenne): A European Economic Community approval indicating that the product complies with LVD/73/23.

NEC Article 725 Types CL2, CL3, PLTC/CL3, (Class 2 & 3 cables)

Plenum	Riser	Commercial	Residential
CL2P	CL2R	CL2	CL2X*
CL3P	CL3R	CL3	CL3X*
(none)	(none)	PLTC*	(none)

NEC Article 760 Type FPL (Power-Limited, Fire Protective Signaling Circuit Cable)

Plenum	Riser	Commercial	Residential
FPLP	FPLR	FPL	(none)

NEC Article 800 Type CM (Communications)

Plenum	Riser	Commercial	Residential
CMP	CMR	CMG, CM	CMX*

NEC Article 336 Type TC (Tray Cable)

NEC Article 690 Type PV (Photovoltaic Wire)

NEC Article 820 Type CATV (Community Antenna Television and Radio Distribution System)

Plenum	Riser	Commercial	Residential
CATVP	CATVR	CATV	CATVX**

*Cable diameter must be less than 0.250" (6.35 mm)

**Cable diameter must be less than 0.375" (9.53 mm)

CSA International

CSA is a nonprofit, independent organization which operates a nationally recognized testing laboratory (NRTL) for electrical and electronic materials and equipment. Alpha Wire Company offers the following types of Canadian CSA certifications on a wide variety of both wire and cable products.

AWM (Appliance Wiring Material) is manufactured in accordance with CSA Standard C22.2 No. 210. These products are intended for the internal wiring of electrical and electronic equipment and interconnecting wiring between equipment. All of these wires and cables must pass one of the following flame tests in order to comply with CSA Certification requirements.

FT1 Vertical Flame Test per CSA C22.2 No. 3 specifies that finished cable shall not propagate a flame or continue to burn for more than one minute after five 15-second applications of the test flame. There is an interval of 15 seconds between flame applications.

FT4 Vertical Flame Test per CSA C22.2 No. 3 for cables in cable trays. This test is similar to, but more severe than, the UL Standard 1581 Vertical Tray flame test. The UL 1581 has its burner at 0° from the horizontal while the FT4 has its burner mounted at 20° from the horizontal with its burner parts facing up. The allowable char length is only 1.5 m (58"), while UL 1581 allows damage up to a maximum of 8 ft (2.4 m).

Agency Approvals

NEC Article 800 (Communications) UL/NEC – CSA/CEC Comparable Flame Test Designations

CMP CSA FT6/UL910 Horizontal Flame and Smoke Test 300,000 BTU

Horizontal flame and smoke test in accordance with ANSI/NFPA Standard 262-1985 (UL 910). The maximum flame spread shall be 1.50 m (58"). The smoke density shall be 0.5 at peak optical density and 0.15 at maximum average optical density. This test does not investigate toxicity, combustion, or decomposition.

CMR UL 1666 Vertical Flame Test 527,500 BTU

A large scale fire test for determining values of flame propagation height for electrical and optical-fiber cables that are intended for installation vertically in shafts. The flame propagation height is not to equal or exceed 12 ft (3.6 m). The temperature of any thermocouple at the 12 ft (3.5 m) height is not to exceed 850°F (454°C). The purpose of the test is to determine whether the flame propagation characteristics of these "riser" cables are in accordance with the NEC. This test does not investigate toxicity, combustion or decomposition.

CMG CSA FT4 Vertical Flame Test 70,000 BTU

This test is more stringent than the UL 1685/UL 1581 (Vertical Tray) in so much as the cable samples must be greater than 13 mm in diameter, if not the cables are grouped in bundles of at least three to obtain an overall group diameter of 13 mm. In addition, the burner is set at a 20° angle from the horizon with the burner ports facing up. This test has a maximum char height of 1.5 m (59") measured from the lower edge of the burner.

CM UL 1581 Section 1160 (Vertical Tray) Flame Test 2500 BTU

This test consist of an essentially flat metal plate burner mounted 0 degrees from the horizon. This test does not distinguish any specific cable size or diameter. This test has a maximum flame and char height of 78" measured from the burner.

CMX CSA FT-1/UL 1581 Section 1080 (VW-1) Vertical Flame Test 1700 BTU

A vertical finished cable shall not flame longer than 60 seconds following any of five 15 second applications of the specified nominal 125-mm premixed 500-W test flame (1700 BTU/hr.), the period between applications being (1) 15 seconds if the cable flaming ceases within 15 seconds or less time or (2) the duration of the cable flaming if the cable flame persists longer than 15 seconds. The cable shall not ignite combustible materials in the vicinity or damage more than 25% of the indicator flag during, between, or after the five applications of the test flame. The CSA FT-1 test is similar; however, it refers to CSA C22.2 No. 3, Paragraph 4.11.1 for flame test procedures.

The descriptions for the above flame tests are paraphrased from the applicable documents. For specific information, please consult the appropriate agency documentation.

Military Specifications

Military Specifications	
MIL-DTL-17	RG cables-polyethylene and PTFE cores.
MIL-W-76	General purpose hook-up wire for internal wiring of electronic equipment. Temperature range -40°C to +80°C vinyl, Types LW, MH, HW for service up to 2500 volts, polyethylene Type HF to 1000 volts.
MIL-W-3861	Copper conductors (uninsulated). Solid, bunches, concentric and rope constructions. Replaced by QQ-W-343 then superseded by A-A-59551.
MIL-DTL-16878	Military specification, covering unshielded wire for hook-up and lead wiring of electronic and electrical components and equipment. Formerly MIL-DTL-16878.
MIL-DTL-22759	PTFE insulated hook-up wire MIL-DTL-22759.
MIL-DTL-27500	600 volt aircraft wire with PTFE insulation. Formerly MIL-DTL-27500.
QQ-W-343	Copper conductors (uninsulated). Solid, bunches, concentric and rope constructions. Superseded by A-A-59551.
AMS-DTL-23053	General specification for heat shrinkable insulation sleeving. Formerly MIL-DTL-23053.
MIL-L-631	Non-rigid synthetic resin composition electrical insulation. May be in the form of film, sheets, tapes, or tubing.
MIL-I-3190	General specification for coated, flexible insulation sleeving.
A-A 59551	Wire, electrical, copper (uninsulated).
A-A 59569	Braid, wire (copper, tin-coated, silver-plated, or nickel coated, tubular or flat).
A-A 52080	Tape, lacing and tying, nylon.
A-A 52081	Tape, lacing and tying, polyester.
A-A-52083	Tape, lacing and tying, glass.
A-A-52084	Tape, lacing and tying, aramid.
A-A-59602	Tube, spiral wrap, polyethylene, PTFE and polyamide.
A-A-59301	Sleeving, textile, braided, synthetic polymer, -55°C to +105°C.
MIL-DTL-713	Twine, fibrous: impregnated, lacing and tying.
FED-STD-191	Textile test methods.
MIL-Y-1140	Yarn, cord, sleeving, cloth and tape-glass.
NEMA HP-3	PTFE insulated hook-up wire.

Military Cross Reference Index to Alpha Tubing and Sleeving Products

Heat-Shrink Tubing	
MIL-SPEC	Alpha Tubing Family
AMS-DTL-23053/1, CL 1,2	FIT- 600, ST-700
AMS-DTL-23053/2, CL 2, CL2 Except Longitudinal Shrinkage	Special Order
AMS-DTL-23053/4, CL 1, 2 & 3	FIT-300, FIT-750, FIT-321, ST-300, ST-302, ST-303
AMS-DTL-23053/5, CL , 2 & 3, CL1 Overexpanded	FIT-221, FIT-221B, FIT-221V, FIT-421, FIT-321V (except dimensions), FIT-421, ST-421
AMS-DTL-23053/6, CL 1 & 2	FIT-295
AMS-DTL-23053/8	FIT-350
AMS-DTL-23053/11, CL 1	FIT-400
AMS-DTL-23053/12, CL 3	FIT-500
AMS-DTL-23053/12, CL 5	Special Order
AMS-DTL-23053/13	FIT-650, ST-650
AMS-DTL-23053/18, CL	FIT-CLEAR
AMS-DTL-23053/15, CL1 & 2	SPC, SPCM

Extruded Tubing	
MIL-SPEC	Alpha Tubing Family
MIL-I-631D	PVC-105

Coated-Fiberglass Sleeving	
MIL-SPEC	Alpha Sleeving Family
MIL-I-3190/3 Type C	AF-155
MIL-I-3190/2 Type B	PIF-130
MIL-I-3190/2 Type B	MPF-130
MIL-I-3190/6 Type D	PIF-200
MIL-Y-1140	PIF-240

Spirally Cut Tubing	
MIL-SPEC	Part No.
A-A-59602, Type 1	SW-1 to SW-6
A-A-59602, Type 2	SW-20 to SW-25
A-A-59602, Type 3	SW-30 to SW-35
A-A-59602, Type 1	SW-40 to SW-45

Military Specifications

Military Cross Reference Index to Alpha Tubing and Sleeving Products

Expandable Self-Fitting Sleeving	
MIL-SPEC	Alpha Sleeving Family
A-A-59301	XS-200N

Lacing Cords and Tapes	
MIL-SPEC	Part No.
A-A-52080 Type 3, Finish C, FED STD 191	LC-132
A-A-52080 Type 4, Finish B, FED STD 191	LC-134
A-A-52080 Type 3, Finish B, FED STD 191	LC-136
A-A-52080 Type 3, Finish C, FED STD 191	LC-140
A-A-52080 Type 3, Finish E, FED STD 191	LC-143
A-A-52080 Type 5, Finish A, FED STD 191	801530
A-A-52080 Type 5, Finish B, FED STD 191	801536
A-A-52080 Type 4, Finish B, FED STD 191	802534
A-A-52080 Type 2, Finish C, FED STD 191	805032
A-A-52080 Type 3, Finish B, FED STD 191	805036
A-A-52080 Type 3, Finish C, FED STD 191	805040
A-A-52081 Type 3, Finish B, FED STD 191	LC-162
A-A-52081 Type 5, Finish C, FED STD 191	801566
A-A-52081 Type 4, Finish C, FED STD 191	802566
A-A-52081 Type 3, Finish C, FED STD 191	805058
A-A-52081 Type 3, Finish A, FED STD 191	805060
A-A-52081 Type 3, Finish B, FED STD 191	805062
A-A-52081 Type 3, Finish C, FED STD 191	805066
A-A-52083 Type 3, Finish G, FED STD 191	807510

FIT Heat-Shrink Tubing

Competitive Cross Reference

Competitive Cross Reference						
FIT Series	Sumitomo Electric	Tyco Electronics/ Raychem	3M	DSG-Canusa	Panduit	Insultab
105	F2	—	—	—	HSTTP	HS-105
221	A2, B2	RNF-100	FP-301	CPX 100	HSTT, HSTTM	HS-101
221B	A2, B2	RNF-100	FP-301	CPX 100	HSTT	HS-101
221V	B2	VERSAFIT 2:1	FP-301VW	CPX 876	HSTTV	HS-101
260	B2(Y/G)	DCPT	SFTW-202 GYS	CPX 201	—	—
295	BB	CRN	SR-350	CHM 140	—	HS-101SR
300	W5DL	SCL	MW	—	—	HS-101MV
321	W3B2	DWP-125	EPS-300	CPA 100	HSTTA	HS-101MV3:1
321V	B2(3X)	RNF-3000, VERSAFIT 3X	SFTW-303	CPX 300	—	HS-101-3X
350	K	RW-125	Kynar	DERAY KY 175	—	HSK-600
400	—	—	—	—	—	—
421	W3B2(4X)	RP-4800	EPS-400	—	SH277	HS-101MV4:1
500	—	—	—	—	—	—
600	R10	NT	NST	—	—	HSN-100
621	BCH(6X)	HRNF	—	—	—	—
650	FE3	VITON	VTN200	—	—	HS-VTN
700	—	SST	ITCS, HDT	CFW-D	—	—
750	O2B2	TAT-125	EPS-200	CPA 100	—	HS-101MV2:1
CLEAR	K2	RW-175	Kynar	DERAY KYF 190	—	—
CAP	—	101 A0xx	—	—	—	—
CRIMP	—	D406	MH18, MH14, MH10	—	—	—
FABRIC	—	HFT5000	—	—	—	—
FLEX	—	SRFR	—	—	—	—
SLV	—	SO1xx-R/ SO2-xx-R	—	—	—	—

Xtra-Guard Flex Cables

Competitive Cross Reference

Lapp to Alpha							
Lapp	Alpha	Lapp	Alpha	Lapp	Alpha	Lapp	Alpha
28110	87007	601604CY	65604CY	602204TP	86704CY	602625	86125
28160	87304	601605	65605	602205	86305	602625S	86125CY
28171	87403	601605CY	65605CY	602205TP	86705CY	602802	86002
28172	87404	601607	65607	602206TP	86706CY	602802S	86002CY
28174	87407	601607CY	65607CY	602207	86307	602803	86003
28181	87503	601609	65609	602208TP	86708CY	602803S	86003CY
28182	87504	601612	65612	602210TP	86710CY	602804	86004
28184	87603	601612CY	65612CY	602214TP	86714CY	602804S	86004CY
600204	65304	601618	65618	602225	86325	602805	86005
600204CY	65304CY	601618CY	65618CY	602401TP	86601CY	602805S	86005CY
600205	65305	601625	65625	602402	86202	602807	86007
600404	65504	601625CY	65625CY	602402S	86202CY	602807S	86007CY
600405	65505	601641	65641	602402TP	86602CY	602812S	86012CY
600604	65704	601650	65650	602403	86203	602818S	86018CY
600604CY	65704CY	601802	65802	602403S	86203CY	602825	86025
600605	65705	601803	65803	602403TP	86603CY	602825S	86025CY
600804	65904	601803CY	65803CY	602404	86204	811442	87003
600804CY	65904CY	601804	65804	602404S	86204CY	811443	87004
600805	65905	601804CY	65804CY	602404TP	86604CY	890204	85304
601003	65103	601805	65805	602405	86205	890204CY	85304CY
601003CY	65103CY	601805CY	65805CY	602405S	86205CY	890404	85504
601004	65104	601807	65807	602405TP	86605CY	890404CY	85504CY
601004CY	65104CY	601807CY	65807CY	602406TP	86606CY	890604	85704
601005	65105	601809	65809	602407	86207	890604CY	85704CY
601005CY	65105CY	601812	65812	602407S	86207CY	890804	85904
601007CY	65107CY	601812CY	65812CY	602408TP	86608CY	890804CY	85904CY
601203	65203	601818	65818	602410TP	86610CY	891004	85104
601203CY	65203CY	601818CY	65818CY	602412S	86212CY	891004CY	85104CY
601204	65204	601825	65825	602414TP	86614CY	891007	85107
601204CY	65204CY	601825CY	65825CY	602418S	86218CY	891007CY	85107CY
601205	65205	601834	65834	602425	86225	891204	85204
601205CY	65205CY	601841	65841	602425S	86225CY	891204CY	85204CY
601207	65207	601850	65850	602601TP	86501CY	891207	85207
601402	65402	602002	65002	602602	86102	891207CY	85207CY
601403	65403	602003	65003	602602S	86102CY	891404	85404
601403CY	65403CY	602003CY	65003CY	602602TP	86502CY	891404CY	85404CY
601404	65404	602004	65004	602603	86103	891407	85407
601404CY	65404CY	602005	65005	602603S	86103CY	891407CY	85407CY
601405	65405	602007	65007	602603TP	86503CY	891603	85603
601405CY	65405CY	602007CY	65007CY	602604	86104	891603CY	85603CY
601407	65407	602009	65009	602604S	86104CY	891604	85604
601407CY	65407CY	602012	65012	602604TP	86504CY	891604CY	85604CY
601409	65409	602012CY	65012CY	602605	86105	891605	85605
601412	65412	602018	65018	602605S	86105CY	891605CY	85605CY
601412CY	65412CY	602025	65025	602605TP	86505CY	891607	85607
601418	65418	602025CY	65025CY	602606TP	86506CY	891607CY	85607CY
601418CY	65418CY	602201TP	86701CY	602607	86107	891612	85612
601425	65425	602202	86302	602607S	86107CY	891612CY	85612CY
601602	65602	602202TP	86702CY	602608TP	86508CY	891618	85618
601603	65603	602203	86303	602610TP	86510CY	891618CY	85618CY
601603CY	65603CY	602203TP	86703CY	602612S	86112CY	891625	85625
601604	65604	602204	86304	602618S	86118CY	891625CY	85625CY

Xtra-Guard Flex Cables

Competitive Cross Reference

Lapp to Alpha							
Lapp	Alpha	Lapp	Alpha	Lapp	Alpha	Lapp	Alpha
891634	85634	891807	85807	891834	85834	892010CY	85010CY
891634CY	85634CY	891807CY	85807CY	892003	85003	892012	85012
891650	85650	891812	85812	892003CY	85003CY	892012CY	85012CY
891803	85803	891812CY	85812CY	892004	85004	892018	85018
891803CY	85803CY	891815	85815	892004CY	85004CY	892018CY	85018CY
891804	85804	891818	85818	892005	85005	892025	85025
891804CY	85804CY	891818CY	85818CY	892005CY	85005CY	892025CY	85025CY
891805	85805	891825	85825	892007	85007	892034	85034
891805CY	85805CY	891825CY	85825CY	892007CY	85007CY		

HELUKABEL	Alpha	HELUKABEL	Alpha	HELUKABEL	Alpha	HELUKABEL	Alpha
10001	65002	10142	65204	15077	85407	18031	86204
10002	65003	10143	65205	15143	85204	18032	86205
10004	65004	10144	65207	15145	85104	18034	86207
10006	65005	10147	65103	15147	85904	18037	86212
10009	65007	10148	65104	15149	85704	18040	86218
10013	65012	10149	65105	15151	85634CY	18057	86302
10016	65018	10152	65904	15160	85904CY	18058	86303
10019	65025	10153	65905	15162	85704CY	18059	86304
10030	65802	10155	65704	15926	85404CY	18060	86305
10031	65803	10156	65705	15928	85407CY	18062	86307
10033	65804	10158	65504	15931	85003CY	18065	86312
10035	65805	10159	65505	15932	85004CY	18068	86318
10038	65807	10161	65304	15933	85005CY	18096	86325
10041	65809	10162	65305	15934	85007CY	18117	86125
10043	65812	15002	85003	15935	85012CY	18118	86225
10047	65818	15003	85004	15936	85018CY	20001	86102CY
10050	65825	15004	85005	15938	85025CY	20002	86103CY
10052	65834	15005	85007	15946	85803CY	20003	86104CY
10054	65841	15007	85012	15947	85804CY	20004	86105CY
10056	65850	15010	85018	15948	85805CY	20006	86107CY
10090	65602	15012	85025	15949	85807CY	20009	86112CY
10091	65603	15014	85034	15950	85812CY	20012	86118CY
10093	65604	15020	85803	15951	85818CY	20029	86202CY
10095	65605	15021	85804	15952	85825CY	20030	86203CY
10098	65607	15022	85805	15977	85603CY	20031	86204CY
10101	65609	15023	85807	15978	85604CY	20032	86205CY
10103	65612	15025	85812	15979	85605CY	20033	86207CY
10107	65618	15028	85818	15980	85607CY	20036	86212CY
10110	65625	15030	85825	15981	85612CY	20039	86218CY
10113	65641	15032	85834	15982	85618CY	20091	86125CY
10115	65650	15056	85603	15983	85625CY	20092	86225CY
10120	65402	15057	85604	18001	86102	83774	86501CY
10121	65403	15058	85605	18002	86103	83775	86502CY
10123	65404	15059	85607	18003	86104	83776	86503CY
10125	65405	15061	85612	18004	86105	83777	86504CY
10127	65407	15064	85618	18006	86107	83778	86505CY
10130	65412	15066	85625	18009	86112	83779	86506CY
10132	65418	15068	85634	18012	86118	83781	86508CY
10134	65425	15071	85650	18029	86202	83782	86510CY
10141	65203	15075	85404	18030	86203	83784	86514CY

Xtra-Guard Flex Cables

Competitive Cross Reference

HELUKABEL to Alpha

HELUKABEL	Alpha	HELUKABEL	Alpha	HELUKABEL	Alpha	HELUKABEL	Alpha
83792	86601CY	83797	86606CY	83811	86702CY	83817	86708CY
83793	86602CY	83799	86608CY	83812	86703CY	83818	86710CY
83794	86603CY	83800	86610CY	83813	86704CY	83820	86714CY
83795	86604CY	83802	86614CY	83814	86705CY		
83796	86605CY	83810	86701CY	83815	86706CY		

Igus to Alpha

Igus	Alpha	Igus	Alpha	Igus	Alpha	Igus	Alpha
CF130-05-02	65002	CF140-07-05	65805CY	CF240-01-04	86104CY	CF5-15-07	85607
CF130-05-03	65003	CF140-07-07	65807CY	CF240-01-05	86105CY	CF5-15-12	85612
CF130-05-04	65004	CF140-07-12	65812CY	CF240-01-07	86107CY	CF5-15-18	85618
CF130-05-05	65005	CF140-07-18	65818CY	CF240-01-18	86118CY	CF5-15-25	85625
CF130-05-07	65007	CF140-07-25	65825CY	CF240-02-03	86203CY	CF5-25-04	85404
CF130-07-04	65804	CF140-15-03	65603CY	CF240-02-04	86204CY	CF5-25-07	85407
CF130-07-05	65805	CF140-15-04	65604CY	CF240-02-05	86205CY	CF6-05-05	85005CY
CF130-07-07	65807	CF140-15-05	65605CY	CF240-02-07	86207CY	CF6-05-12	85012CY
CF130-07-12	65812	CF140-15-07	65607CY	CF240-02-18	86218CY	CF6-05-18	85018CY
CF130-07-18	65818	CF140-15-12	65612CY	CF5-05-03	85003	CF6-07-03	85803CY
CF130-07-25	65825	CF140-15-18	65618CY	CF5-05-07	85007	CF6-07-04	85804CY
CF130-15-03	65603	CF140-15-25	65625CY	CF5-05-12	85012	CF6-07-05	85805CY
CF130-15-04	65604	CF140-25-04	65404CY	CF5-05-18	85018	CF6-07-07	85807CY
CF130-15-05	65605	CF211-02-01-02	86601CY	CF5-05-25	85025	CF6-07-12	85812CY
CF130-15-07	65607	CF211-02-02-02	86602CY	CF5-07-04	85804	CF6-07-18	85818CY
CF130-15-12	65612	CF211-02-03-02	86603CY	CF5-07-05	85805	CF6-15-03	85603CY
CF130-15-18	65618	CF211-02-04-02	86604CY	CF5-07-07	85807	CF6-15-04	85604CY
CF130-15-25	65625	CF211-02-05-02	86605CY	CF5-07-12	85812	CF6-15-05	85605CY
CF130-25-04	65404	CF211-02-06-02	86606CY	CF5-07-18	85818	CF6-15-07	85607CY
CF130-25-07	65407	CF211-02-08-02	86608CY	CF5-07-25	85825	CF6-15-12	85612CY
CF130-25-12	65412	CF211-02-10-02	86610CY	CF5-15-03	85603	CF6-15-18	85618CY
CF140-07-03	65803CY	CF211-02-14-02	86614CY	CF5-15-04	85604	CF6-15-25	85625CY
CF140-07-04	65804CY	CF240-01-03	86103CY	CF5-15-05	85605	CF6-25-04	85404CY

Lutze to Alpha

Lutze	Alpha	Lutze	Alpha	Lutze	Alpha	Lutze	Alpha
100154	85207	100431	65604	100467	65103	100794	85618
100215	65007	100432	65605	100468	65104	100795	85625
100354	65705	100433	65607	100471	65904	100796	85603
100358	65025	100437	65612	100473	65704	100797	85407
100363	65002	100440	65618	100475	65905	100808	85605
100364	65003	100443	65625	100480	65504	100998	85812
100365	65004	100447	65650	100481	65304	101049	85003
100366	65005	100453	65403	100707	85404	101050	85104
100370	65012	100454	65404	100766	85803	101351	85010CY
100373	65018	100455	65405	100767	85805	108003	85404CY
100385	65803	100456	65407	100768	85807	108019	85107
100386	65804	100458	65412	100771	85834	108049	85204
100392	65812	100460	65418	100780	85650	108055	85018CY
100398	65825	100461	65425	100782	85818	110016	86102CY
100400	65834	100464	65204	100784	85825	110017	86103CY
100421	65850	100465	65105	100787	85604	110018	86104CY
100429	65602	100465	65205	100792	85607	110019	86105CY
100430	65603	100466	65207	100793	85612	110021	86107CY

Xtra-Guard Flex Cables

Lutze to Alpha							
Lutze	Alpha	Lutze	Alpha	Lutze	Alpha	Lutze	Alpha
110023	86112CY	110601	86503CY	111245	85805CY	116135	65407CY
110026	86118CY	110602	86504CY	111303	85607CY	116150	65204CY
110090	86203CY	110604	86506CY	111304	85612CY	116153	65104CY
110091	86204CY	110606	86510CY	111305	85618CY	118039	85005CY
110092	86205CY	110618	86602CY	111306	85625CY	118111	85204CY
110096	86212CY	110619	86603CY	116100	65803CY	118112	85104CY
110099	86218CY	110620	86604CY	116102	65804CY	118194	85605CY
110387	65805	110622	86606CY	116103	65805CY	118195	86605CY
110389	65807	110633	86702CY	116104	65807CY	118251	86608CY
110395	65818	110634	86703CY	116105	65812CY	118383	85004
110411	86207CY	110635	86704CY	116106	65818CY	118384	85007
110423	85004CY	110637	86706CY	116107	65825CY	118389	65402
110441	85803CY	110665	86710CY	116121	65603CY	119132	85818CY
110447	85012	110774	85003CY	116123	65604CY	A1032202	86302
110447	85012CY	110775	85007CY	116124	65605CY	A1032203	86303
110486	85825CY	110776	85025	116125	65607CY	A1032204	86304
110490	85807CY	110776	85025CY	116126	65612CY	A1032225	86325
110491	85812CY	110908	86202CY	116127	65618CY	A1032402	86202
110499	85604CY	110954	85603CY	116128	65625CY	A1032403	86203
110566	85804CY	111045	85804	116132	65403CY	A1032404	86204
110591	85018	111047	86125CY	116133	65404CY	A1032425	86225
110600	86502CY	111049	86225CY	116134	65405CY		

SAB	Alpha	SAB	Alpha	SAB	Alpha	SAB	Alpha
02040204	65304	02041612	65612	02591003	65103CY	02592007	65007CY
02040404	65504	02041618	65618	02591004	65104CY	02592012	65012CY
02040604	65704	02041625	65625	02591005	65105CY	02592025	65025CY
02040804	65904	02041641	65641	02591203	65203CY	07750204	85304
02040805	65905	02041802	65802	02591204	65204CY	07750404	85504
02041003	65103	02041803	65803	02591205	65205CY	07750604	85704
02041004	65104	02041804	65804	02591403	65403CY	07750804	85904
02041005	65105	02041805	65805	02591404	65404CY	07751004	85104
02041203	65203	02041807	65807	02591405	65405CY	07751007	85107
02041204	65204	02041809	65809	02591407	65407CY	07751204	85204
02041205	65205	02041812	65812	02591412	65412CY	07751207	85207
02041207	65207	02041818	65818	02591418	65418CY	07751404	85404
02041402	65402	02041825	65825	02591603	65603CY	07751407	85407
02041403	65403	02041834	65834	02591604	65604CY	07751603	85603
02041404	65404	02041841	65841	02591605	65605CY	07751604	85604
02041405	65405	02042002	65002	02591607	65607CY	07751605	85605
02041407	65407	02042003	65003	02591612	65612CY	07751607	85607
02041409	65409	02042004	65004	02591618	65618CY	07751612	85612
02041412	65412	02042005	65005	02591625	65625CY	07751618	85618
02041418	65418	02042007	65007	02591803	65803CY	07751625	85625
02041425	65425	02042009	65009	02591804	65804CY	07751634	85634
02041602	65602	02042012	65012	02591805	65805CY	07751650	85650
02041603	65603	02042018	65018	02591807	65807CY	07751803	85803
02041604	65604	02042025	65025	02591812	65812CY	07751804	85804
02041605	65605	02590204	65304CY	02591818	65818CY	07751805	85805
02041607	65607	02590604	65704CY	02591825	65825CY	07751807	85807
02041609	65609	02590804	65904CY	02592003	65003CY	07751812	85812

Xtra-Guard Flex Cables

Competitive Cross Reference

SAB to Alpha

SAB	Alpha	SAB	Alpha	SAB	Alpha	SAB	Alpha
07751815	85815	07850404	85504CY	07851612	85612CY	07852007	85007CY
07751818	85818	07850604	85704CY	07851618	85618CY	07852010	85010CY
07751825	85825	07850804	85904CY	07851625	85625CY	07852012	85012CY
07751834	85834	07851004	85104CY	07851803	85803CY	07852018	85018CY
07752003	85003	07851007	85107CY	07851804	85804CY	07852025	85025CY
07752004	85004	07851204	85204CY	07851805	85805CY	07951203	87603
07752005	85005	07851207	85207CY	07851807	85807CY	07951403	87503
07752007	85007	07851404	85404CY	07851812	85812CY	07951404	87504
07752012	85012	07851407	85407CY	07851818	85818CY	07951603	87403
07752018	85018	07851603	85603CY	07851825	85825CY	07951604	87404
07752025	85025	07851604	85604CY	07852003	85003CY	07951607	87407
07752034	85034	07851605	85605CY	07852004	85004CY	07951804	87304
07850204	85304CY	07851607	85607CY	07852005	85005CY	07952407	87007

Belden to Alpha

Belden	Alpha	Belden	Alpha	Belden	Alpha	Belden	Alpha
7101A	85003	7122A	85603	7408A	65025	7427AS	65612CY
7101AS	85003CY	7122AS	85603CY	7408AS	65025CY	7428A	65618
7102A	85004	7123A	85604	7409A	65802	7428AS	65618CY
7102AS	85004CY	7123AS	85604CY	7410A	65803	7429A	65625
7103A	85005	7123AS	85825CY	7410AS	65803CY	7429AS	65625CY
7103AS	85005CY	7124A	85605	7411A	65804	7431A	65641
7104A	85007	7124AS	85605CY	7411AS	65804CY	7434A	65402
7104AS	85007CY	7125A	85607	7412A	65805	7435A	65403
7106A	85012	7125AS	85607CY	7412AS	65805CY	7435AS	65403CY
7106AS	85012CY	7127AS	85812CY	7413A	65807	7436A	65404
7107A	85018	7128AS	85818CY	7413AS	65807CY	7436AS	65404CY
7107AS	85018CY	7136A	85404	7414A	65809	7437A	65405
7108A	85025	7136AS	85404CY	7415A	65812	7437AS	65405CY
7108AS	85025CY	7137A	85407	7415AS	65812CY	7438A	65407
7110A	85803	7137AS	85407CY	7416A	65818	7438AS	65407CY
7110AS	85803CY	7145A	85204	7416AS	65818CY	7439A	65409
7111A	85804	7145AS	85204CY	7417A	65825	7440A	65412
7111AS	85804CY	7146A	85207	7417AS	65825CY	7441A	65418
7112A	85805	7146AS	85207CY	7418A	65834	7442A	65425
7112AS	85805CY	7147A	85104	7419A	65841	7444A	65203
7113A	85807	7174AS	85104CY	7420A	65850	7444AS	65203CY
7113AS	85807CY	7400A	65002	7421A	65602	7445A	65204
7115A	85612	7401A	65003	7422A	65603	7445AS	65204CY
7115AS	85812	7401AS	65003CY	7422AS	65603CY	7446A	65103
7115AS	85612CY	7402A	65004	7423A	65604	7446AS	65103CY
7116A	85618	7403A	65005	7423AS	65604CY	7447A	65104
7116AS	85818	7404A	65007	7424A	65605	7447AS	65104CY
7116AS	85618CY	7404AS	65007CY	7424AS	65605CY	7448A	65105
7117A	85625	7405A	65009	7425A	65607	7448AS	65105CY
7117AS	85825	7406A	65012	7425AS	65607CY	7461A	65205
7117AS	85625CY	7406AS	65012CY	7426A	65609	7461AS	65205CY
7118A	85634	7407A	65018	7427A	65612		

Lapp to Alpha Wire Series XM

Cross Reference

Lapp			Alpha Wire Series XM			Lapp			Alpha Wire Series XM			Lapp			Alpha Wire Series XM		
Part No.	Part No.	Page No.	Part No.	Part No.	Page No.	Part No.	Part No.	Page No.	Part No.	Part No.	Page No.	Part No.	Part No.	Page No.	Part No.	Part No.	Page No.
891803	XM1803R	136	891604CY	XM1604RCY	138	891404	XM1404L	136									
891804	XM1804R	136	891605CY	XM1605RCY	138	891405	XM1405L	136									
891805	XM1805R	136	891607CY	XM1607RCY	138	891407	XM1407L	136									
891807	XM1807R	136	891612CY	XM1612RCY	138	891412	XM1412L	136									
891812	XM1812R	136	891617CY	XM1617RCY	138	891203	XM1203L	137									
891817	XM1817R	136	891619CY	XM1619RCY	138	891204	XM1204L	137									
891822	XM1822R	136	891622CY	XM1622RCY	138	891205	XM1205L	137									
891825	XM1825R	136	891625CY	XM1625RCY	138	891207	XM1207L	137									
891834	XM1834R	136	891633CY	XM1633RCY	138	891003	XM1003L	137									
891842	XM1842R	136	891642CY	XM1642RCY	138	891004	XM1004L	137									
891849	XM1849R	136	891649CY	XM1649RCY	138	891005	XM1005L	137									
891865	XM1865R	136	891403CY	XM1403RCY	138	891007	XM1007L	137									
891603	XM1603R	136	891404CY	XM1404RCY	138	890803	XM0803L	137									
891604	XM1604R	136	891405CY	XM1405RCY	138	890804	XM0804L	137									
891605	XM1605R	136	891407CY	XM1407RCY	138	891803CY	XM1803LCY	138									
891607	XM1607R	136	891412CY	XM1412RCY	138	891804CY	XM1804LCY	138									
891612	XM1612R	136	891203CY	XM1203RCY	139	891805CY	XM1805LCY	138									
891617	XM1617R	136	891204CY	XM1204RCY	139	891807CY	XM1807LCY	138									
891619	XM1619R	136	891205CY	XM1205RCY	139	891812CY	XM1812LCY	138									
891622	XM1622R	136	891207CY	XM1207RCY	139	891817CY	XM1817LCY	138									
891625	XM1625R	136	891003CY	XM1003RCY	139	891822CY	XM1822LCY	138									
891633	XM1633R	136	891004CY	XM1004RCY	139	891825CY	XM1825LCY	138									
891642	XM1642R	136	891005CY	XM1005RCY	139	891834CY	XM1834LCY	138									
891649	XM1649R	136	891007CY	XM1007RCY	139	891842CY	XM1842LCY	138									
891665	XM1665R	136	890803CY	XM0803RCY	139	891849CY	XM1849LCY	138									
891403	XM1403R	136	890804CY	XM0804RCY	139	891603CY	XM1603LCY	138									
891404	XM1404R	136	891803	XM1803L	136	891604CY	XM1604LCY	138									
891405	XM1405R	136	891804	XM1804L	136	891605CY	XM1605LCY	138									
891407	XM1407R	136	891805	XM1805L	136	891607CY	XM1607LCY	138									
891412	XM1412R	136	891807	XM1807L	136	891612CY	XM1612LCY	138									
891203	XM1203R	137	891812	XM1812L	136	891617CY	XM1617LCY	138									
891204	XM1204R	137	891817	XM1817L	136	891619CY	XM1619LCY	138									
891205	XM1205R	137	891822	XM1822L	136	891622CY	XM1622LCY	138									
891207	XM1207R	137	891825	XM1825L	136	891625CY	XM1625LCY	138									
891003	XM1003R	137	891834	XM1834L	136	891633CY	XM1633LCY	138									
891004	XM1004R	137	891842	XM1842L	136	891642CY	XM1642LCY	138									
891005	XM1005R	137	891849	XM1849L	136	891649CY	XM1649LCY	138									
891007	XM1007R	137	891865	XM1865L	136	891403CY	XM1403LCY	138									
890803	XM0803R	137	891603	XM1603L	136	891404CY	XM1404LCY	138									
890804	XM0804R	137	891604	XM1604L	136	891405CY	XM1405LCY	138									
891803CY	XM1803RCY	138	891605	XM1605L	136	891407CY	XM1407LCY	138									
891804CY	XM1804RCY	138	891607	XM1607L	136	891412CY	XM1412LCY	138									
891805CY	XM1805RCY	138	891612	XM1612L	136	891203CY	XM1203LCY	139									
891807CY	XM1807RCY	138	891617	XM1617L	136	891204CY	XM1204LCY	139									
891812CY	XM1812RCY	138	891619	XM1619L	136	891205CY	XM1205LCY	139									
891817CY	XM1817RCY	138	891622	XM1622L	136	891207CY	XM1207LCY	139									
891822CY	XM1822RCY	138	891625	XM1625L	136	891003CY	XM1003LCY	139									
891825CY	XM1825RCY	138	891633	XM1633L	136	891004CY	XM1004LCY	139									
891834CY	XM1834RCY	138	891642	XM1642L	136	891005CY	XM1005LCY	139									
891842CY	XM1842RCY	138	891649	XM1649L	136	891007CY	XM1007LCY	139									
891849CY	XM1849RCY	138	891665	XM1665L	136	890803CY	XM0803LCY	139									
891603CY	XM1603RCY	138	891403	XM1403L	136	890804CY	XM0804LCY	139									

Lapp to Alpha Wire Series XM

Cross Reference

Lapp			Alpha Wire Series XM			Lapp			Alpha Wire Series XM		
Part No.	Part No.	Page No.	Part No.	Part No.	Page No.	Part No.	Part No.	Page No.	Part No.	Part No.	Page No.
891803	XM1803K	136	891604CY	XM1604KCY	138						
891804	XM1804K	136	891605CY	XM1605KCY	138						
891805	XM1805K	136	891607CY	XM1607KCY	138						
891807	XM1807K	136	891612CY	XM1612KCY	138						
891812	XM1812K	136	891617CY	XM1617KCY	138						
891817	XM1817K	136	891619CY	XM1619KCY	138						
891822	XM1822K	136	891622CY	XM1622KCY	138						
891825	XM1825K	136	891625CY	XM1625KCY	138						
891834	XM1834K	136	891633CY	XM1633KCY	138						
891842	XM1842K	136	891642CY	XM1642KCY	138						
891849	XM1849K	136	891649CY	XM1649KCY	138						
891865	XM1865K	136	891403CY	XM1403KCY	138						
891603	XM1603K	136	891404CY	XM1404KCY	138						
891604	XM1604K	136	891405CY	XM1405KCY	138						
891605	XM1605K	136	891407CY	XM1407KCY	138						
891607	XM1607K	136	891412CY	XM1412KCY	138						
891612	XM1612K	136	891203CY	XM1203KCY	139						
891617	XM1617K	136	891204CY	XM1204KCY	139						
891619	XM1619K	136	891205CY	XM1205KCY	139						
891622	XM1622K	136	891207CY	XM1207KCY	139						
891625	XM1625K	136	891003CY	XM1003KCY	139						
891633	XM1633K	136	891004CY	XM1004KCY	139						
891642	XM1642K	136	891005CY	XM1005KCY	139						
891649	XM1649K	136	891007CY	XM1007KCY	139						
891665	XM1665K	136	890803CY	XM0803KCY	139						
891403	XM1403K	136	890804CY	XM0804KCY	139						
891404	XM1404K	136									
891405	XM1405K	136									
891407	XM1407K	136									
891412	XM1412K	136									
891203	XM1203K	137									
891204	XM1204K	137									
891205	XM1205K	137									
891207	XM1207K	137									
891003	XM1003K	137									
891004	XM1004K	137									
891005	XM1005K	137									
891007	XM1007K	137									
890803	XM0803K	137									
890804	XM0804K	137									
891803CY	XM1803KCY	138									
891804CY	XM1804KCY	138									
891805CY	XM1805KCY	138									
891807CY	XM1807KCY	138									
891812CY	XM1812KCY	138									
891817CY	XM1817KCY	138									
891822CY	XM1822KCY	138									
891825CY	XM1825KCY	138									
891834CY	XM1834KCY	138									
891842CY	XM1842KCY	138									
891849CY	XM1849KCY	138									
891603CY	XM1603KCY	138									

Belden to Alpha Wire

Cross Reference

Belden			Alpha Wire			Belden			Alpha Wire			Belden			Alpha Wire		
Part No.	Part No.	Page No.	Part No.	Part No.	Page No.	Part No.	Part No.	Page No.	Part No.	Part No.	Page No.	Part No.	Part No.	Page No.	Part No.	Part No.	Page No.
1001A	5711/2008	290	8105	6225C	355	8336	6366	351	8336	6366	351	8336	6366	351	8336	6366	351
1002A	5711/2012	290	8106	6226C	355	8337	6367	351	8337	6367	351	8337	6367	351	8337	6367	351
1021A	5712/2024	290	8107	6227C	355	8340	6368	351	8340	6368	351	8340	6368	351	8340	6368	351
1022A	5712/2036	290	8108	6228C	355	8342	6369	351	8342	6369	351	8342	6369	351	8342	6369	351
1083A	5650B2004	211	8110	6230C	355	8345	6370	351	8345	6370	351	8345	6370	351	8345	6370	351
1084A	5650B2008	211	8112	6230/12C	355	8348	6371	351	8348	6371	351	8348	6371	351	8348	6371	351
1091A	5620B2020	215	8115	6230/15C	355	8355	6372	351	8355	6372	351	8355	6372	351	8355	6372	351
1102A	5711/2004	290	8118	6230/18C	355	8403	1713	329	8403	1713	329	8403	1713	329	8403	1713	329
1103A	5712/2008	290	8125	6230/25C	355	8404	1715	329	8404	1715	329	8404	1715	329	8404	1715	329
1104A	5713/2004	290	8132	3492C	354	8405	1716	329	8405	1716	329	8405	1716	329	8405	1716	329
1106A	5713/2012	290	8133	3493C	354	8407	1451/16	330	8407	1451/16	330	8407	1451/16	330	8407	1451/16	330
1107A	5713/2024	290	8134	3494C	354	8408	1450/16	330	8408	1450/16	330	8408	1450/16	330	8408	1450/16	330
1192A	1772	328	8135	3495C	354	8411	1703	327	8411	1703	327	8411	1703	327	8411	1703	327
1419A	6202C	347	8138	3498C	354	8422	1710	327	8422	1710	327	8422	1710	327	8422	1710	327
1420A	6203C	347	8142	3500/12C	354	8430	1115	368	8430	1115	368	8430	1115	368	8430	1115	368
1421A	6204C	347	8148	3500/18C	354	8434	2468	349	8434	2468	349	8434	2468	349	8434	2468	349
1422A	6205C	347	8153	3500/25C	354	8437	1775C	323	8437	1775C	323	8437	1775C	323	8437	1775C	323
1423A	6206C	347	8155	3500/25C	354	8441	1736C	323	8441	1736C	323	8441	1736C	323	8441	1736C	323
1424A	6210/12C	347	8162	6316	362	8442	1172C	308	8442	1172C	308	8442	1172C	308	8442	1172C	308
1425A	6210/15C	347	8163	6317	362	8443	1173C	308	8443	1173C	308	8443	1173C	308	8443	1173C	308
7307A	87303	119	8164	6318	362	8444	1174C	308	8444	1174C	308	8444	1174C	308	8444	1174C	308
7308A	87304	119	8165	6319	362	8445	1175C	308	8445	1175C	308	8445	1175C	308	8445	1175C	308
7310A	87307	119	8166	6320	362	8446	1826C	313	8446	1826C	313	8446	1826C	313	8446	1826C	313
7320A	87203	119	8167	6321	362	8448	1828C	313	8448	1828C	313	8448	1828C	313	8448	1828C	313
7321A	87204	119	8168	6322	362	8450	2460C	316	8450	2460C	316	8450	2460C	316	8450	2460C	316
7322A	87207	119	8170	6323	362	8451	2461C	316	8451	2461C	316	8451	2461C	316	8451	2461C	316
7328A	87403	120	8175	6324	362	8453	1951/3	273	8453	1951/3	273	8453	1951/3	273	8453	1951/3	273
7329A	87404	120	8178	6325	362	8456	1180C	308	8456	1180C	308	8456	1180C	308	8456	1180C	308
7330A	87407	120	8185	6326	362	8457	1181C	308	8457	1181C	308	8457	1181C	308	8457	1181C	308
7332A	87503	120	8205	1895C	309	8458	1181/15C	308	8458	1181/15C	308	8458	1181/15C	308	8458	1181/15C	308
7333A	87504	120	8227	9817	246	8459	1181/25C	308	8459	1181/25C	308	8459	1181/25C	308	8459	1181/25C	308
7334A	87507	120	8241	9059C	250	8465	1898/5C	309	8465	1898/5C	309	8465	1898/5C	309	8465	1898/5C	309
7336A	87603	120	8259	9058AC	238	8466	1898/12C	309	8466	1898/12C	309	8466	1898/12C	309	8466	1898/12C	309
7337A	87604	120	8262	9058C	238	8467	1898/7C	309	8467	1898/7C	309	8467	1898/7C	309	8467	1898/7C	309
7338A	87607	120	8263	9059B	250	8468	1898/15C	309	8468	1898/15C	309	8468	1898/15C	309	8468	1898/15C	309
7339A	87703	120	8302	6373	351	8469	1898/9C	306	8469	1898/9C	306	8469	1898/9C	306	8469	1898/9C	306
7340A	87704	120	8303	6374	351	8471	1899C	309	8471	1899C	309	8471	1899C	309	8471	1899C	309
7341A	87705	120	8304	6375	351	8484	1896/4C	309	8484	1896/4C	309	8484	1896/4C	309	8484	1896/4C	309
8011	289	422	8305	6376	351	8489	1898/4C	309	8489	1898/4C	309	8489	1898/4C	309	8489	1898/4C	309
8012	286	422	8306	6377	351	8500	1858/19	309	8500	1858/19	309	8500	1858/19	309	8500	1858/19	309
8013	295	422	8307	6378	351	8501	1857	309	8501	1857	309	8501	1857	309	8501	1857	309
8019	296	422	8308	6379	351	8502	1856	384	8502	1856	384	8502	1856	384	8502	1856	384
8020	297	422	8310	6380	351	8503	1855	384	8503	1855	384	8503	1855	384	8503	1855	384
8021	298	422	8312	6381	351	8504	1854	384	8504	1854	384	8504	1854	384	8504	1854	384
8022	299	422	8315	6382	351	8505	1853	384	8505	1853	384	8505	1853	384	8505	1853	384
8023	299/1	422	8318	6383	351	8520	1559	390	8520	1559	390	8520	1559	390	8520	1559	390
8024	299/2	422	8325	6384	351	8521	1557	390	8521	1557	390	8521	1557	390	8521	1557	390
8025	299/3	422	8332	6362	351	8522	1555	390	8522	1555	390	8522	1555	390	8522	1555	390
8102	6222C	355	8333	6363	351	8523	1553	390	8523	1553	390	8523	1553	390	8523	1553	390
8103	6223C	355	8334	6364	351	8524	1551	390	8524	1551	390	8524	1551	390	8524	1551	390
8104	6224C	355	8335	6365	351	8525	1550	390	8525	1550	390	8525	1550	390	8525	1550	390

Belden to Alpha Wire

Cross Reference

Belden			Alpha Wire			Belden			Alpha Wire			Belden			Alpha Wire		
Part No.	Part No.	Page No.	Part No.	Part No.	Page No.	Part No.	Part No.	Page No.	Part No.	Part No.	Page No.	Part No.	Part No.	Page No.	Part No.	Part No.	Page No.
8527	1560	390	8763	1243/3C	316	9388	6444	358	8529	1563	390	8766	6008C	357	9389	6445	358
8530	1561	390	8767	6000C	357	9390	6446	358	8538	1561/24	390	8769	6020C	357	9391	6447	358
8597	1852	384	8770	2423C	314	9392	6448	358	8601	725	278	8771	2403C	314	9402	6416	341
8619	1898/19C	309	8772	2413C	314	9406	6052C	356	8620	1064	311	8772	2413C	314	9421	1178C	308
8621	1067	311	8773	6022C	357	9423	1179C	308	8622	1072	311	8774	6014C	357	9430	1177C	308
8623	1075	311	8775	6016C	357	9431	1181/20C	308	8624	1079	311	8776	6018C	357	9432	1181/30C	308
8627	1274	311	8777	6010C	357	9433	1181/40C	308	8628	1277	311	8778	6012C	357	9434	1181/50C	308
8629	1282	311	8780	2260	319	9439	1896/7C	309	8629	1282	311	8790	2258	319	9445	1896/5C	309
8641	2400C	314	8791	2258/3	319	9455	1896/9C	309	8641	2400C	314	8879	650	292	9457	1896/12C	309
8661	2170	521	8879	650	292	9478	760/2	278	8661	2170	521	8916	3079	383	9479	760/4	278
8662	2173	521	8899	1636	406	9486	5606B1801	208	8662	2173	521	8917	3077	383	9487	5606B1601	208
8663	2142	521	8916	3079	383	9501	5471C	341	8663	2142	521	8918	3075	383	9502	5472C	341
8668	2168	521	8917	3077	383	9503	5473C	341	8668	2168	521	8919	3073	383	9504	5474C	341
8669	2174	521	8918	3075	383	9505	5475C	341	8669	2174	521	9182	9823	246	9506	5476C	341
8670	2175	521	8919	3073	383	9507	5477C	341	8670	2175	521	9184	6072C	370	9507	5477C	341
8690	1133C	340	8920	3071	383	9508	5478C	341	8690	1133C	340	9209	9810	250	9508	5478C	341
8691	1136C	340	9156	1132C	340	9509	5479C	341	8691	1136C	340	9244	9830	250	9509	5479C	341
8692	1139C	340	9157	1134C	340	9510	5480C	341	8692	1139C	340	9251	9008	250	9510	5480C	341
8718	2473	348	9158	1306C	340	9512	6417	344	8718	2473	348	9269	9062AC	250	9512	6417	344
8719	2471	348	9159	1135C	340	9513	6418	344	8719	2471	348	9302	5902C	342	9513	6418	344
8720	2472	348	9161	1138C	340	9514	6419	344	8720	2472	348	9305	5905C	342	9514	6419	344
8722	2465C	316	9182	9823	246	9515	5480/15C	341	8722	2465C	316	9306	5906C	342	9515	5480/15C	341
8723	2466C	361	9184	6072C	370	9516	6420	344	8723	2466C	361	9309	5909C	342	9516	6420	344
8724	2464C	316	9209	9810	250	9519	5480/19C	341	8724	2464C	316	9315	5909/15C	342	9519	5480/19C	341
8725	2467C	361	9244	9830	250	9520	6421	344	8725	2467C	361	9319	5909/19C	342	9520	6421	344
8732	1243/4	313	9251	9008	250	9521	6422	344	8732	1243/4	313	9322	5610B2201	204	9521	6422	344
8734	1243	313	9269	9062AC	250	9524	6423	344	8734	1243	313	9328	6434	358	9524	6423	344
8735	1737C	323	9302	5902C	342	9525	5480/25C	341	8735	1737C	323	9329	6435	358	9525	5480/25C	341
8737	2254	319	9305	5905C	342	9526	6424	344	8737	2254	319	9330	6436	358	9526	6424	344
8740	1793C	308	9306	5906C	342	9527	6425	344	8740	1793C	308	9331	6437	358	9527	6425	344
8741	1302C	340	9309	5909C	342	9533	6300/3	318	8741	1302C	340	9332	6438	358	9533	6300/3	318
8742	1304C	340	9315	5909/15C	342	9534	6300/4	318	8742	1304C	340	9333	6439	358	9534	6300/4	318
8743	1307C	340	9319	5909/19C	342	9535	6305	318	8743	1307C	340	9335	6440	358	9535	6305	318
8746	1313C	340	9322	5610B2201	204	9536	6306	318	8746	1313C	340	9337	6441	358	9536	6306	318
8747	1322C	340	9328	6434	358	9538	6300/8	318	8747	1322C	340	9344	5616B1201	206	9538	6300/8	318
8748	1323C	340	9329	6435	358	9540	6300/10	318	8748	1323C	340	9363	5640B2201	210	9540	6300/10	318
8749	1327C	340	9330	6436	358	9542	6308	318	8749	1327C	340	9369	6443	358	9542	6308	318
8753	1308/11C	340	9331	6437	358				8753	1308/11C	340						
8754	1309C	340	9332	6438	358				8754	1309C	340						
8755	1313C	340	9333	6439	358				8755	1313C	340						
8757	1305C	340	9335	6440	358				8757	1305C	340						
8759	2256	319	9337	6441	358				8759	2256	319						
8760	2421C	314	9344	5616B1201	206				8760	2421C	314						
8761	2401C	314	9363	5640B2201	210				8761	2401C	314						
8762	2411C	314	9369	6443	358				8762	2411C	314						

Belden to Alpha Wire

Cross Reference

Belden			Alpha Wire			Belden			Alpha Wire			Belden			Alpha Wire		
Part No.	Part No.	Page No.	Part No.	Part No.	Page No.	Part No.	Part No.	Page No.	Part No.	Part No.	Page No.	Part No.	Part No.	Page No.	Part No.	Part No.	Page No.
9543	6309	318	9774	6024C	357	9931	6354	338									
9544	6310	318	9775	6025C	357	9932	6355	338									
9545	6311	318	9776	6018C	357	9933	6356	338									
9546	6312	318	9784	6076C	370	9934	6357	338									
9550	5480/50C	344	9804	6390	352	9935	6358	338									
9551	6426	344	9805	6391	352	9936	6359	338									
9552	6427	344	9806	6392	352	9937	6360	338									
9553	6428	344	9807	6393	352	9938	6361	338									
9554	6429	344	9808	6394	352	9939	6339	338									
9556	6430	344	9809	6395	352	9940	6340	338									
9559	6431	344	9812	6396	352	9941	6341	338									
9563	6432	344	9813	6397	352	9942	6342	338									
9565	6433	344	9814	6400	352	9943	6343	338									
9608	6327	338	9819	6398	352	9944	6344	338									
9609	6328	338	9825	6399	352	9945	6345	338									
9610	6329	338	9829	6401	353	9946	6346	338									
9611	6330	338	9830	6402	353	9947	6347	338									
9612	6331	338	9831	6403	353	9948	6348	338									
9613	6332	338	9832	6404	353	9949	6349	338									
9614	6333	338	9833	6406	353	9950	6350	338									
9615	6334	338	9834	6407	353	9951	3245	322									
9616	6335	338	9835	6408	353	9952	3246	322									
9617	6336	338	9836	6409	353	9953	3247	322									
9618	6337	338	9837	6410	353	9954	3248	322									
9619	6338	338	9838	6411	353	9961	3230	322									
9620	1065	311	9839	6405	353	9962	3231	322									
9621	1069	311	9841	6412	353	9963	3232	322									
9622	1085	311	9842	6413	353	9964	3233	322									
9623	1275	311	9843	6414	353	9965	3220	321									
9626	1898/25C	309	9844	6415	353	9966	3221	321									
9637	3470/25C	336	9873	6033C	357	9967	3222	321									
9680	6083C	345	9874	6036C	357	9968	3223	321									
9681	6084C	345	9875	6039C	357	9980	3254	381									
9682	6301	346	9877	6042C	357	9981	3253	381									
9683	6089C	345	9883	6314	359	9982	3252	381									
9684	6304	346	9886	6315	359	9983	3251	381									
9730	6073C	370	9891	9852C	254	9984	3250	381									
9731	6076C	370	9892	9853C	254	9990	6385	360									
9733	6079/11C	370	9903	9854C	254	9991	6386	360									
9734	6079/12C	370	9910	3081	383	9992	6387	360									
9735	6079/15C	370	9912	3080	383	9993	6388	360									
9738	6079/27C	370	9916	3057	380	9995	6389	360									
9740	1897C	309	9918	3055	380	9999	9888C	246									
9743	1149C	340	9919	3053	380	19201	1937	272									
9744	1317C	340	9921	3051	380	19202	1936	272									
9745	1318C	340	9923	3050	380	19203	1935	272									
9746	1319C	340	9924	3070	383	19204	1934	272									
9747	1325C	340	9925	6351	339	19205	1938/3	272									
9748	1327/19C	340	9926	3049	380	19206	1937/3	272									
9768	6017C	357	9927	6352	380	19207	1936/3	272									
9769	6019C	357	9928	3048	380	19208	1935/3	272									
9773	6023C	357	9929	6353	338	19209	1934/3	272									

Belden to Alpha Wire

Cross Reference

Belden			Alpha Wire			Belden			Alpha Wire			Belden			Alpha Wire		
Part No.	Part No.	Page No.	Part No.	Part No.	Page No.	Part No.	Part No.	Page No.	Part No.	Part No.	Page No.	Part No.	Part No.	Page No.	Part No.	Part No.	Page No.
19216	1937/4	272	83321	2829/2	335	9L28060	3580/60	371									
19217	1936/4	272	83322	2826/2	335	9L28064	3580/64	371									
19227	1932	272	83333	2821/3	334	9L28309	3590/9	373									
19228	1933	272	83334	2824/3	334	9L28310	3590/10	373									
19229	1932/3	272	83335	2827/3	334	9L28315	3590/15	373									
19230	1933/3	272	83336	2829/3	335	9L28320	3590/20	373									
19348	1952/3T	273	83337	2826/3	335	9L28325	3590/25	373									
19349	1953/3T	273	83348	2821/4	334	9L28326	3590/26	373									
19350	1951/3T	273	83349	2824/4	334	9L28334	3590/34	373									
19352	1941/3	273	83350	2827/4	334	9L28337	3590/37	373									
19354	1943/3	273	83351	2829/4	335	9L28340	3590/40	373									
19363	1942/3F	273	83352	2826/4	335	9L28350	3590/50	373									
19364	1943/3F	273	87108	9102	335	9L28360	3590/60	373									
82503	58803	366	87120	9104	338	9L30026	3582/26	375									
82504	58804	366	87241	9159	335	9L30050	3582/50	375									
82506	58806	366	87292	9105	335	9R28010	3583/10	368									
82512	58812	366	87723	58612	367	9R28014	3583/14	371									
82777	58613	367	87777	58613	367	9R28016	3583/16	371									
82778	58616	367	87778	58616	367	9R28020	3583/20	371									
83000	5851	401	88102	58902	366	9R28024	3583/24	371									
83001	5852	401	88103	58903	366	9R28025	3583/25	371									
83002	5853	401	88104	58904	366	9R28026	3583/26	371									
83003	5854	401	88106	58906	366	9R28034	3583/34	371									
83004	5854/7	401	88109	58909	366	9R28037	3583/37	371									
83005	5855/7	401	88112	58912	366	9R28040	3583/40	371									
83006	5855	401	88240	9158S	238	9R28050	3583/50	371									
83007	5856	401	88241	9159	250	9R28060	3583/60	371									
83008	5856/7	401	88641	58401	363	9R28064	3583/64	371									
83009	5857	401	88723	58612	367												
83010	5858	401	88761	58411	365												
83023	5874	402	88777	58613	367												
83025	5875	402	88778	58616	367												
83026	5875	402	89108	9102	250												
83027	5876	402	89120	9104	252												
83028	5876	402	89207	9109	246												
83029	5877	402	89272	9108	246												
83030	5878	402	89292	9105	252												
83041	2840/7	399	89503	58803	366												
83043	2841/7	399	89504	58804	366												
83045	2842/7	399	9L28009	3580/9	371												
83046	2843/7	399	9L28010	3580/10	371												
83047	2844/7	399	9L28014	3580/14	371												
83048	2844/19	399	9L28015	3580/15	371												
83049	2845/7	399	9L28016	3580/16	371												
83050	2845/19	399	9L28020	3580/20	371												
83304	2821	334	9L28024	3580/24	371												
83305	2824	334	9L28025	3580/25	371												
83306	2827	334	9L28026	3580/26	371												
83308	2826	335	9L28034	3580/34	371												
83318	2821/2	334	9L28037	3580/37	371												
83319	2824/2	334	9L28040	3580/40	371												
83320	2827/2	334	9L28050	3580/50	371												

General Cable to Alpha Wire

Cross Reference

General			Alpha Wire			General			Alpha Wire			General			Alpha Wire		
Part No.	Part No.	Page No.	Part No.	Part No.	Page No.	Part No.	Part No.	Page No.	Part No.	Part No.	Page No.	Part No.	Part No.	Page No.	Part No.	Part No.	Page No.
395031	9810	250	C0611A	5480/19C	341	C0835A	6408	353	C0911A	6073C	370	C0924A	6316	362	C0951A	6327	338
86013	1941/3	273	C0612A	5480/25C	341	C0836A	6409	353	C0913A	6076C	370	C0925A	6317	362	C0952A	6328	338
C0450A	5610B2201	204	C0620A	6362	351	C0839A	6405	353	C0915A	6079/11C	370	C0926A	6318	362	C0953A	6329	338
C0451A	5640B2201	208	C0621A	6363	351	C0841A	6412	353	C0916A	6079/12C	370	C0948A	3470/25C	336	C0954A	6330	338
C0515A	6222C	355	C0622A	6364	351	C0842A	6413	353	C0917A	6079/15C	370	C0955A	6331	338	C0955A	6331	338
C0516A	6223C	355	C0623A	6365	351	C0843A	6414	353	C0924A	6316	362	C0956A	6332	338	C0956A	6332	338
C0517A	6224C	355	C0624A	6366	351	C0911A	6073C	370	C0925A	6317	362	C0957A	6333	338	C0957A	6333	338
C0518A	6225C	355	C0625A	6367	351	C0913A	6076C	370	C0926A	6318	362	C0958A	6334	338	C0958A	6334	338
C0519A	6226C	355	C0628A	6368	351	C0915A	6079/11C	370	C0948A	3470/25C	336	C0959A	6335	338	C0959A	6335	338
C0520A	6227C	355	C0630A	6369	351	C0916A	6079/12C	370	C0951A	6327	338	C0961A	6336	338	C0961A	6336	338
C0521A	6228C	355	C0650A	6373	351	C0917A	6079/15C	370	C0952A	6328	338	C0971A	6339	338	C0971A	6339	338
C0522A	6230C	355	C0651A	6374	351	C0924A	6316	362	C0953A	6329	338	C0972A	6340	338	C0972A	6340	338
C0523A	6230/12C	355	C0652A	6375	351	C0925A	6317	362	C0954A	6330	338	C0973A	6341	338	C0973A	6341	338
C0524A	6230/15C	355	C0653A	6376	351	C0926A	6318	362	C0955A	6331	338	C0974A	6342	338	C0974A	6342	338
C0525A	6230/18C	355	C0654A	6377	351	C0948A	3470/25C	336	C0956A	6332	338	C0975A	6343	338	C0975A	6343	338
C0526A	6230/25C	355	C0655A	6378	351	C0951A	6327	338	C0957A	6333	338	C0976A	6344	338	C0976A	6344	338
C0550A	6417	344	C0656A	6379	351	C0952A	6328	338	C0958A	6334	338	C0977A	6345	338	C0977A	6345	338
C0551A	6418	344	C0658A	6380	351	C0953A	6329	338	C0959A	6335	338	C0978A	6346	338	C0978A	6346	338
C0552A	6419	344	C0660A	6381	351	C0954A	6330	338	C0961A	6336	338	C0979A	6347	338	C0979A	6347	338
C0553A	6420	344	C0663A	6384	351	C0955A	6331	338	C1106	9059B	250	C0981A	6348	338	C0981A	6348	338
C0554A	6421	344	C0680A	6351	339	C0956A	6332	338	C1155	9058C	250	C106	9059B	250	C106	9059B	250
C0555A	6422	344	C0681A	6352	339	C0957A	6333	338	C1164	9062AC	244	C1155	9058C	250	C1155	9058C	250
C0556A	6423	344	C0682A	6353	338	C0958A	6334	338	C1178	9058AC	238	C1321	1636	406	C1321	1636	406
C0560A	6427	344	C0683A	6354	338	C0959A	6335	338	C1322A	1710	327	C1322A	1710	327	C1322A	1710	327
C0561A	6428	344	C0684A	6355	338	C0961A	6336	338	C1331A	2465C	316	C1331A	2465C	316	C1331A	2465C	316
C0562A	6429	344	C0685A	6356	338	C0971A	6339	338	C1333A	1243/3C	316	C1333A	1243/3C	316	C1333A	1243/3C	316
C0563A	6430	344	C0686A	6357	338	C0972A	6340	338	C1338A	1243/4	313	C1338A	1243/4	313	C1338A	1243/4	313
C0564A	6431	344	C0687A	6358	338	C0973A	6341	338	C1340A	2464C	316	C1340A	2464C	316	C1340A	2464C	316
C0566A	6433	344	C0688A	6359	338	C0974A	6342	338	C1350A	6052C	356	C1350A	6052C	356	C1350A	6052C	356
C0570A	6434	358	C0741A	6300/3	318	C0975A	6343	338	C1352A	2466C	361	C1352A	2466C	361	C1352A	2466C	361
C0571A	6435	358	C0742A	6300/4	318	C0976A	6344	338	C1368A	2467C	361	C1368A	2467C	361	C1368A	2467C	361
C0572A	6436	358	C0743A	6306	318	C0977A	6345	338	C1670A	5902C	342	C1670A	5902C	342	C1670A	5902C	342
C0573A	6437	358	C0744A	6300/8	318	C0978A	6346	338	C1671A	5906C	342	C1671A	5906C	342	C1671A	5906C	342
C0574A	6438	358	C0745A	6300/10	318	C0979A	6347	338	C1672A	5909C	342	C1672A	5909C	342	C1672A	5909C	342
C0575A	6439	358	C0747A	6308	318	C0981A	6348	338	C1673A	5909/15C	342	C1673A	5909/15C	342	C1673A	5909/15C	342
C0585A	6443	358	C0748A	6309	318	C1106	9059B	250									
C0586A	6444	358	C0749A	6310	318	C1155	9058C	250									
C0587A	6445	358	C0750A	6311	318	C1164	9062AC	244									
C0588A	6446	358	C0751A	6312	318	C1178	9058AC	238									
C0589A	6447	358	C0753A	6305	318	C1321	1636	406									
C0590A	6448	358	C0804A	6390	352	C1322A	1710	327									
C0600A	5471C	341	C0805A	6391	352	C1331A	2465C	316									
C0601A	5472C	341	C0806A	6392	352	C1333A	1243/3C	316									
C0602A	5473C	341	C0807A	6393	352	C1338A	1243/4	313									
C0603A	5474C	341	C0808A	6394	352	C1340A	2464C	316									
C0604A	5475C	341	C0809A	6395	352	C1350A	6052C	356									
C0605A	5476C	341	C0812A	6396	352	C1352A	2466C	361									
C0606A	5477C	341	C0829A	6401	353	C1368A	2467C	361									
C0607A	5478C	341	C0830A	6402	353	C1670A	5902C	342									
C0608A	5479C	341	C0831A	6403	353	C1671A	5906C	342									
C0609A	5480C	341	C0832A	6404	353	C1672A	5909C	342									
C0610A	5480/15C	341	C0833A	6406	353	C1673A	5909/15C	342									

General Cable to Alpha Wire

Cross Reference

General			Alpha Wire			General			Alpha Wire			General			Alpha Wire		
Part No.	Part No.	Page No.	Part No.	Part No.	Page No.	Part No.	Part No.	Page No.	Part No.	Part No.	Page No.	Part No.	Part No.	Page No.	Part No.	Part No.	Page No.
C1676A	5905C	342	C2888A	2256	319	C6065A	6385	360	C6065A	6385	360	C6065A	6385	360	C6065A	6385	360
C2015A	3050	380	C2892A	2258	319	C6066A	6386	360	C6066A	6386	360	C6066A	6386	360	C6066A	6386	360
C2016A	3051	380	C2895A	2260	319	C6067A	6387	360	C6067A	6387	360	C6067A	6387	360	C6067A	6387	360
C2040A	3053	380	C4008A	1793C	308	C6101A	1897C	309	C6101A	1897C	309	C6101A	1897C	309	C6101A	1897C	309
C2064A	3055	380	C4010A	1302C	340	C6103A	1133C	340	C6103A	1133C	340	C6103A	1133C	340	C6103A	1133C	340
C2065A	3057	380	C4014A	1304C	340	C6106A	1136C	340	C6106A	1136C	340	C6106A	1136C	340	C6106A	1136C	340
C2100A	3070	383	C4015A	1305C	340	C6109A	1139C	340	C6109A	1139C	340	C6109A	1139C	340	C6109A	1139C	340
C2101A	3071	383	C4017A	1307C	340	C6118A	1132C	360	C6118A	1132C	360	C6118A	1132C	360	C6118A	1132C	360
C2102A	3073	383	C4062A	1173C	308	C6119A	1134C	360	C6119A	1134C	360	C6119A	1134C	360	C6119A	1134C	360
C2103A	3075	383	C4063A	1174C	308	C6120A	1135C	360	C6120A	1135C	360	C6120A	1135C	360	C6120A	1135C	360
C2104A	3077	383	C4064A	1175C	308	C6121A	1138C	360	C6121A	1138C	360	C6121A	1138C	360	C6121A	1138C	360
C2105A	3079	383	C4065A	1178C	308	C6348A	1172C	308	C6348A	1172C	308	C6348A	1172C	308	C6348A	1172C	308
C2106A	3080	383	C4067A	1181C	308	C6351A	1895C	309	C6351A	1895C	309	C6351A	1895C	309	C6351A	1895C	309
C2107A	3081	383	C4070A	1179C	308	C6355A	1896/5C	309	C6355A	1896/5C	309	C6355A	1896/5C	309	C6355A	1896/5C	309
C2404A	1898/4C	309	C4071A	1180C	308	C6356A	1896/7C	309	C6356A	1896/7C	309	C6356A	1896/7C	309	C6356A	1896/7C	309
C2405A	1899C	309	C4073A	1181/15C	308	C6357A	1896/9C	309	C6357A	1896/9C	309	C6357A	1896/9C	309	C6357A	1896/9C	309
C2412A	1898/12C	309	C4075A	1181/20C	308	C6358A	1896/15C	309	C6358A	1896/15C	309	C6358A	1896/15C	309	C6358A	1896/15C	309
C2420A	1898/5C	309	C4076A	1181/25C	308	C6360A	1896/12C	309	C6360A	1896/12C	309	C6360A	1896/12C	309	C6360A	1896/12C	309
C2421A	1898/7C	309	C4077A	1181/30C	308	C7106A	6416	341	C7106A	6416	341	C7106A	6416	341	C7106A	6416	341
C2422A	1898/9C	309	C4078A	1181/40C	308	C7600A	1550	390	C7600A	1550	390	C7600A	1550	390	C7600A	1550	390
C2423A	1898/15C	309	C4079A	1181/50C	308	C7602A	1551	390	C7602A	1551	390	C7602A	1551	390	C7602A	1551	390
C2424A	1898/19C	309	C4081A	1826C	313	C7604A	1553	390	C7604A	1553	390	C7604A	1553	390	C7604A	1553	390
C2425A	1064	311	C4083A	1828C	313	C7606A	1555	390	C7606A	1555	390	C7606A	1555	390	C7606A	1555	390
C2426A	1067	311	C4088A	1177C	308	C7608A	1557	390	C7608A	1557	390	C7608A	1557	390	C7608A	1557	390
C2426A	2170	521	C4844A	6415	353	C7610A	1559	390	C7610A	1559	390	C7610A	1559	390	C7610A	1559	390
C2427A	1072	311	C6010A	1317C	340	C7611A	1560	390	C7611A	1560	390	C7611A	1560	390	C7611A	1560	390
C2428A	1075	311	C6014A	1318C	340	C8014	9823	246	C8014	9823	246	C8014	9823	246	C8014	9823	246
C2429A	1079	311	C6015A	1319C	340	C8109	58411	365	C8109	58411	365	C8109	58411	365	C8109	58411	365
C2430A	1274	311	C6017A	1322C	340	C8112	58612	367	C8112	58612	367	C8112	58612	367	C8112	58612	367
C2431A	1277	311	C6019A	1323C	340	C8113	58803	366	C8113	58803	366	C8113	58803	366	C8113	58803	366
C2433A	1898/25C	309	C6023A	1325C	340	C8131	58613	367	C8131	58613	367	C8131	58613	367	C8131	58613	367
C2434A	1065	311	C6026A	1327C	340	C8132	58616	367	C8132	58616	367	C8132	58616	367	C8132	58616	367
C2435A	1069	311	C6035A	6000C	357	C8133	58616	367	C8133	58616	367	C8133	58616	367	C8133	58616	367
C2436A	1085	311	C6040A	6010C	357												
C2437A	1275	311	C6041A	6012C	357												
C2513A	2400C	314	C6042A	6014C	357												
C2514A	2401C	314	C6043A	6016C	357												
C2515A	2460C	316	C6044A	6018C	357												
C2516A	2461C	316	C6045A	6020C	357												
C2524A	2411C	314	C6046A	6022C	357												
C2525A	2413C	314	C6047A	6023C	357												
C2526A	2403C	314	C6048A	6024C	357												
C2534A	2421C	314	C6049A	6025C	357												
C2535A	2423C	314	C6050A	6018C	357												
C2536A	2471	348	C6052A	6033C	357												
C2538A	2472	348	C6053A	6036C	357												
C2539A	2473	348	C6054A	6039C	357												
C2676A	1775C	323	C6056A	6042C	357												
C2677A	1736C	323	C6059A	6017C	357												
C2678A	1737C	323	C6060A	6019C	357												
C2768A	2258/3	319	C6061A	6314	359												
C2882A	2254	319	C6062A	6315	359												

Fahrenheit-to-Celsius Conversion

Temperature Conversion Formula: °F = $\frac{9}{5}$ (°C + 32)

°F	°C	°F	°C	°F	°C	°F	°C	°F	°C
-40	-40.00	36	2.22	92	33.33	148	64.44	220	104.44
-38	-38.89	37	2.78	93	33.89	149	65.00	225	107.22
-36	-37.78	38	3.33	94	34.44	150	65.56	230	110.00
-34	-36.67	39	3.89	95	35.00	151	66.11	235	112.78
-32	-35.56	40	4.44	96	35.56	152	66.66	240	115.56
-30	-34.44	41	5.00	97	36.11	153	67.22	245	118.33
-28	-33.33	42	5.56	98	36.67	154	67.77	250	121.11
-26	-32.22	43	6.11	99	37.22	155	68.33	255	123.89
-24	-31.11	44	6.67	100	37.78	156	68.88	260	126.67
-22	-30.00	45	7.22	101	38.33	157	69.44	265	129.44
-20	-28.89	46	7.78	102	38.88	156	70.00	270	132.22
-18	-27.78	47	8.33	103	39.44	159	70.55	275	135.00
-16	-26.67	48	8.89	104	40.00	160	71.11	280	137.78
-14	-25.56	49	9.44	105	40.55	161	71.66	285	140.55
-12	-24.44	50	10.00	106	41.11	162	72.22	290	143.33
-10	-23.33	51	10.56	107	41.66	163	72.77	295	146.11
-8	-22.22	52	11.11	108	42.22	164	73.33	300	148.89
-6	-21.11	53	11.67	109	42.77	165	73.89	305	151.67
-4	-20.00	54	12.22	110	43.33	166	74.44	310	154.44
-2	-18.89	55	12.78	111	43.88	167	75.00	315	157.22
0	-17.78	56	13.33	112	44.44	168	75.55	320	160.00
1	-17.22	57	13.89	113	45.00	169	76.11	325	162.78
2	-16.67	58	14.44	114	45.55	170	76.67	330	165.56
3	-16.11	59	15.00	115	46.11	171	77.22	335	168.33
4	-15.56	60	15.56	116	46.66	172	77.77	340	171.11
5	-15.00	61	16.11	117	47.22	173	78.33	345	173.89
6	-14.44	62	16.67	118	47.77	174	78.88	350	176.67
7	-13.89	63	17.22	119	48.33	175	79.44	355	179.44
8	-13.33	64	17.78	120	48.89	176	80.00	360	182.22
9	-12.78	65	18.33	121	49.44	177	80.55	365	185.00
10	-12.22	66	18.89	122	50.00	178	81.11	370	187.78
11	-11.67	67	19.44	123	50.55	179	81.66	375	190.55
12	-11.11	68	20.00	124	51.11	180	82.22	380	193.33
13	-10.56	69	20.56	125	51.67	181	82.77	385	196.11
14	-10.00	70	21.11	126	52.22	182	83.33	390	198.89
15	-9.44	71	21.67	127	52.77	183	83.88	395	201.67
16	-8.89	72	22.22	128	53.33	184	84.44	400	204.44
17	-8.33	73	22.78	129	53.88	185	85.00	405	207.22
18	-7.78	74	23.33	130	54.44	186	85.55	410	210.00
19	-7.22	75	23.89	131	55.00	187	86.11	415	212.78
20	-6.67	76	24.44	132	55.55	188	86.66	420	215.56
21	-6.11	77	25.00	133	56.11	189	87.22	425	218.33
22	-5.56	78	25.56	134	56.66	190	87.78	430	221.11
23	-5.00	79	26.11	135	57.22	191	88.33	435	223.89
24	-4.44	80	26.67	136	57.77	192	88.88	440	226.67
25	-3.89	81	27.22	137	58.33	193	89.44	445	229.44
26	-3.33	82	27.78	138	58.88	194	90.00	450	232.22
27	-2.78	83	28.33	139	59.44	195	90.55	455	235.00
28	-2.22	84	28.89	140	60.00	196	91.11	460	237.78
29	-1.67	85	29.44	141	60.55	197	91.66	465	240.55
30	-1.11	86	30.00	142	61.11	198	92.22	470	243.33
31	-0.56	87	30.56	143	61.66	199	92.77	475	246.11
32	0	88	31.11	144	62.22	200	93.33	480	248.89
33	0.56	89	31.67	145	62.78	205	96.11	485	251.67
34	1.11	90	32.22	146	63.33	210	98.89	490	254.44
35	1.67	91	32.78	147	63.88	215	101.67	495	257.22
								500	260.00

Celsius-to-Fahrenheit Conversion

Temperature Conversion Formula: °C = $\frac{5}{9}$ (°F - 32)

°C	°F	°C	°F	°C	°F	°C	°F	°C	°F
-40	-40.00	36	96.80	92	197.60	148	298.40	220	428.00
-38	-36.40	37	98.60	93	199.40	149	300.20	225	437.00
-36	-32.80	38	100.40	94	201.20	150	302.00	230	446.00
-34	-29.20	39	102.20	95	203.00	151	303.80	235	455.00
-32	-25.60	40	104.00	96	204.80	152	305.60	240	464.00
-30	-22.00	41	105.80	97	206.60	153	307.40	245	473.00
-28	-18.40	42	107.60	98	208.40	154	309.20	250	482.00
-26	-14.80	43	109.40	99	210.20	155	311.00	255	491.00
-24	-11.20	44	111.20	100	212.00	156	312.80	260	500.00
-22	-7.60	45	113.00	101	213.80	157	314.60	265	509.00
-20	-4.00	46	114.80	102	215.60	156	312.80	270	518.00
-18	-0.40	47	116.60	103	217.40	159	318.20	275	527.00
-16	3.20	48	118.40	104	219.20	160	320.00	280	536.00
-14	6.80	49	120.20	105	221.00	161	321.80	285	545.00
-12	10.40	50	122.00	106	222.80	162	323.60	290	554.00
-10	14.00	51	123.80	107	224.60	163	325.40	295	563.00
-8	17.60	52	125.60	108	226.40	164	327.20	300	572.00
-6	21.20	53	127.40	109	228.20	165	329.00	305	581.00
-4	24.80	54	129.20	110	230.00	166	330.80	310	590.00
-2	28.40	55	131.00	111	231.80	167	332.60	315	599.00
0	32.00	56	132.80	112	233.60	168	334.40	320	608.00
1	33.80	57	134.60	113	235.40	169	336.20	325	617.00
2	35.60	58	136.40	114	237.20	170	338.00	330	626.00
3	37.40	59	138.20	115	239.00	171	339.80	335	635.00
4	39.20	60	140.00	116	240.80	172	341.60	340	644.00
5	41.00	61	141.80	117	242.60	173	343.40	345	653.00
6	42.80	62	143.60	118	244.40	174	345.20	350	662.00
7	44.60	63	145.40	119	246.20	175	347.00	355	671.00
8	46.40	64	147.20	120	248.00	176	348.80	360	680.00
9	48.20	65	149.00	121	249.80	177	350.60	365	689.00
10	50.00	66	150.80	122	251.60	178	352.40	370	698.00
11	51.80	67	152.60	123	253.40	179	354.20	375	707.00
12	53.60	68	154.40	124	255.20	180	356.00	380	716.00
13	55.40	69	156.20	125	257.00	181	357.80	385	725.00
14	57.20	70	158.00	126	258.80	182	359.60	390	734.00
15	59.00	71	159.80	127	260.60	183	361.40	395	743.00
16	60.80	72	161.60	128	262.40	184	363.20	400	752.00
17	62.60	73	163.40	129	264.20	185	365.00	405	761.00
18	64.40	74	165.20	130	266.00	186	366.80	410	770.00
19	66.20	75	167.00	131	267.80	187	368.60	415	779.00
20	68.00	76	168.80	132	269.60	188	370.40	420	788.00
21	69.80	77	170.60	133	271.40	189	372.20	425	797.00
22	71.60	78	172.40	134	273.20	190	374.00	430	806.00
23	73.40	79	174.20	135	275.00	191	375.80	435	815.00
24	75.20	80	176.00	136	276.80	192	377.60	440	824.00
25	77.00	81	177.80	137	278.60	193	379.40	445	833.00
26	78.80	82	179.60	138	280.40	194	381.20	450	842.00
27	80.60	83	181.40	139	282.20	195	383.00	455	851.00
28	82.40	84	183.20	140	284.00	196	384.80	460	860.00
29	84.20	85	185.00	141	285.80	197	386.60	465	869.00
30	86.00	86	186.80	142	287.60	198	388.40	470	878.00
31	87.80	87	188.60	143	289.40	199	390.20	475	887.00
32	89.60	88	190.40	144	291.20	200	392.00	480	896.00
33	91.40	89	192.20	145	293.00	205	401.00	485	905.00
34	93.20	90	194.00	146	294.80	210	410.00	490	914.00
35	95.00	91	195.80	147	296.60	215	419.00	495	923.00
								500	932.00

Glossary

abrasion resistance Ability of a wire or cable material to resist surface wear.

accelerated aging A test in which voltage, temperature, etc., are increased above normal operating values to obtain observable deterioration in a relatively short period of time. The plotted results give expected service life under normal conditions.

accelerator A chemical additive which hastens a chemical reaction under specific conditions.

adhesive lined For heat-shrink tubing, an inner lining that, when heated, adheres to the substrate, providing additional strength and environmental sealing.

admittance The measure of the ease with which an alternating current flows in a circuit. The reciprocal of impedance.

aging The change in properties of a material with time under specific conditions.

air-spaced coaxial cable One in which air is the essential dielectric material. A spirally wound synthetic filament or spacer may be used to center the conductor.

alloy A metal formed by combining two or more different metals to obtain desirable properties.

ALS A type of cable consisting of insulated conductors enclosed in a continuous, closely fitting aluminum tube.

alternating current (AC) Electric current that continually reverses its direction. It is expressed in cycles per second (hertz or Hz).

ambient temperature The temperature of a medium surrounding an object.

ampacity See current-carrying capacity.

ampere The unit of current. One ampere is the current flowing through one ohm of resistance at one volt potential.

analog circuit Output of electrical signals as a continuous function of input, as contrasted with digital circuit.

anneal Relief of mechanical stress through heat and gradual cooling. Annealing copper renders it less brittle.

annealed wire Wire, which after final drawdown, has been heated and slowly cooled to remove the effects of cold working.

ANSI American National Standards Institute.

anti-oxidant A substance which prevents or slows down oxidation of material exposed to air.

arc resistance The time required for an arc to establish a conductive path in a material.

armor A braid or wrapping of metal, usually steel, used for mechanical protection. Generally placed over the outer jacket.

ASA American Standards Association. Former name of ANSI.

ASCII American Standard Code for Information Interchange.

ASME American Society of Mechanical Engineers.

ASTM American Society for Testing and Materials, a nonprofit industry-wide organization which publishes standards, methods of test, recommended practices, definitions and other related material.

attenuation Power loss in an electrical system. In cables, generally expressed in dB per unit length, usually 1000 ft.

audio frequency The range of frequencies audible to the human ear. Usually 30 Hz to 20,000 Hz.

AWG American Wire Gauge. A standard system for designating wire diameter.

AWM Appliance Wiring Material.

backbone wiring The physical/electrical interconnections between telecommunications closets and equipment rooms. Cross-connect hardware and cabling in the main and intermediate cross-connects are considered part of the backbone wiring.

balanced circuit A circuit so arranged that the impressed voltages on each conductor of the pair are equal in magnitude but opposite in polarity with respect to ground.

band marking A continuous circumferential band applied to a conductor at regular intervals for identification.

bandwidth The difference between the upper and lower limits of a given band of frequencies. Expressed in hertz (Hz).

baud Unit of data transmission speed representing bits per second. 9600 baud = 9600 bits per second.

bend radius The radius of curvature that a wire or cable can bend without causing any damaging effects.

Glossary

binder A spirally served tape or thread used for holding assembled cable components in place awaiting subsequent manufacturing operations.

bit error rate (BER) Discrepancy between outgoing and incoming bits transmitted between data equipment.

bit One binary digit.

bond strength Amount of adhesion between surfaces, e.g. in cemented ribbon cable.

braid A fibrous or metallic group filaments interwoven in cylindrical form to form a covering over one (1) or more wires.

braid angle The smaller of the two angles formed by the shielding strand and the axis of the cable being shielded.

braid carrier A spool or bobbin on a braider which holds one group of strands or filaments consisting of a specific number of ends. The carrier revolves during braiding operations.

braid ends The number of strands used to make up one carrier. The strands are wound side by side on the carrier bobbin and lie parallel in the finished braid.

breakdown voltage The voltage at which the insulation between two conductors is destroyed.

breakout The point at which a conductor or group of conductors is separated from a multiconductor cable to complete circuits at various points along the main cable.

building wire Wire used for light and power, 600 volts or less, usually not exposed to outdoor environment.

bunch stranding A group of wires of the same diameter twisted together without a predetermined pattern.

buried cable A cable installed directly into the earth without the use of underground conduit. Also called “direct burial cable.”

byte A group of eight binary digits.

CSA Canadian Standards Association a nonprofit, independent organization which operates a listing service for electrical and electronic materials and equipment. The Canadian counterpart of the Underwriters Laboratories.

cable An insulated conductor or group of individually insulated conductors in twisted or parallel configuration with a protective jacket.

cable assembly A length of cable with connectors on one or both ends.

cable track, C track Flexible plastic or metallic tray, used to guide and protect cables in high speed motion applications.

cabling The twisting together of two or more insulated conductors to form a cable.

cablings factor Used in the formula for calculating the diameter of an unshielded, unjacketed cable. $D=Kd$, where the D is the cable diameter, K is the factor, and d is the diameter of one insulated conductor.

CAD/CAM Computer aided design/ computer aided manufacturing.

campus backbone Wiring between buildings that share telecommunications facilities.

capacitance The ratio of the electrostatic charge on a conductor to the potential difference between the conductors required to maintain that charge.

capacitance, direct The capacitance measured directly from conductor to conductor through a single insulating layer.

capacitance, mutual The capacitance between two conductors with all other conductors, including shield, short circuited to ground.

capacitive coupling Electrical interaction between two conductors caused by the capacitance between them.

carrier frequency The electromagnetic wave frequency selected to transmit information. Optical carrier frequency is from the infrared, visible range or ultraviolet spectrum areas (10¹² Hz and above).

CE (Conformité Européenne) European Economic Community approval indicating that a product complies with a European Directive.

cellular (foamed) polyethylene Expanded or “foam” polyethylene consisting of individual closed cells suspended in a polyethylene medium.

CENELEC European Economic Community Committee for Standardization of technical requirements.

center-to-center distance See pitch.

certificate of compliance (C of C) A certificate which is normally generated by a quality control department, which shows that the product being shipped meets customer’s specifications.

Glossary

certified test report (CTR) A report providing actual test data on a cable. Tests are normally run by a quality control department, which shows that the product being shipped conforms to test specifications.

characteristic impedance The impedance that, when connected to the output terminals of a transmission line of any length, makes the line appear infinitely long. The ratio of voltage to current at every point along a transmission line on which there are no standing waves.

CIP Common Industrial Protocol. A media-independent application-layer protocol used by DeviceNet, ControlNet, and EtherNet/IP. Trademark of ODVA.

circuit The entire route of an electric current.

circular mil The area of a circle one mil (0.001") in diameter; 7.845×10^{-7} sq. in. Used in expressing wire cross sectional area.

cladding A method of applying a layer of metal over another metal whereby the junction of the two metals is continuously welded.

coaxial cable A cable consisting of two cylindrical conductors with a common axis, separated by a dielectric.

cold flow Permanent deformation of the insulation due to mechanical force or pressure (not due to heat softening).

color code A system for circuit identification through use of solid colors and contrasting tracers.

common axis cabling In multiple cable constructions, a twisting of all conductors about a "common axis" with two conductor groups then selected as pairs. This practice yields smaller diameter constructions than does a separate axis construction, but tends to yield greater susceptance to EMI and ESI.

common mode noise Noise, caused by a difference in "group potential." By grounding at either end rather than both ends (usually grounded at source) one can reduce this interference.

composite cable A cable containing more than one gauge size or a variety of circuit types, e.g., pairs, triples, quads, coaxials, etc.

compound An insulating or jacketing material made by mixing two or more ingredients.

concentric stranding A central wire surrounded by one or more layers of helically wound strands in a fixed round geometric arrangement.

concentricity In a wire or cable, the measurement of the location of the center of the conductor with respect to the geometric center of the surrounding insulation.

conductance The ability of a conductor to carry an electrical charge. The ratio of the current flow to the potential difference causing the flow. The reciprocal of resistance.

conductivity The capability of a material to carry electrical current—usually expressed as a percentage of copper conductivity (copper being 100%).

conductor An uninsulated wire suitable for carrying electrical current.

conductor spacing Distance between the closest edges of two adjacent conductors.

conduit A tube or trough in which insulated wires and cables are passed.

connector A device used to physically and electrically connect two or more conductors.

connector adapter A special type of connector that allows mating of otherwise incompatible connectors. Examples include a female adapter that mates two male connectors; or a connector that mates a 9-position connector to a 25-position connector.

contact The parts of a connector which actually carry the electrical current and are touched together or separated to control the flow.

continuity check A test to determine whether electrical current flows continuously throughout the length of a single wire or individual wires in a cable.

continuous vulcanization Simultaneous extrusion and vulcanization of rubber-like wire coating materials.

control cable A multiconductor cable made for operation in control or signal circuits.

ControlNet An industrial automation protocol that is highly scheduled and deterministic, operates at 5 Mb/s, and uses the same CIP application layer protocol as DeviceNet and EtherNET/IP. Trademark of ODVA.

copolymer A compound resulting from the polymerization of two different monomers.

Glossary

copper A reddish metal that is an excellent conductor of electricity.

copper-clad Steel with a coating of copper welded to it.

Copperweld Copperweld Steel's trademark for copper-covered steel conductor.

cord A small, flexible insulated cable.

core In cables, a component or assembly of components over which additional components (shield, sheath, etc.) are applied.

corona A discharge due to ionization of air around a conductor due to potential gradient exceeding a certain critical value.

corona resistance The time that the insulation will withstand a specified level of field-intensified ionization that does not result in the immediate complete breakdown of the insulation.

corrosion The deterioration of a material by chemical reaction or galvanic action.

coverage The percent of completeness with which a metal braid covers the underlying surface.

CRCS Continuous rigid cable support. Synonymous with tray.

creep The dimensional change with time of a material under load.

cross-linked Inter-molecular bonds between long chain thermoplastic polymers by chemical or electron bombardment means. The properties of the resulting thermosetting material are usually improved.

cross-linked polyethylene A form of polyethylene whose molecules are more closely linked to produce a greater balance of physical and electrical properties.

crosstalk A type of interference caused by signals from one circuit being coupled into adjacent circuits.

C-track A cable guide mechanism manufactured of either plastic or metal used in continuous flexing applications.

current Flow of electricity, measured in amps.

current-carrying capacity The maximum current an insulated conductor can safely carry without exceeding its insulation and jacket temperature limitations.

cut-through resistance The ability of a material to withstand mechanical pressure, (usually a sharp edge or small radius) without separation.

CV Continuous vulcanization.

cycle life The number of repetitive flex motions that a wire or cable can withstand prior to breakdown.

decibel (dB) A unit to express differences of power level. A term that expresses two power levels used to indicate gains or losses in a system.

delay line A cable made to provide a very low velocity of propagation with long electrical delay for transmitted signals.

derating factor A factor used to reduce the current carrying capacity of a wire when used in environments other than that for which the value was established.

DeviceNet An industrial automation protocol operating in either a master/slave or distributed fashion to connect controllers to sensors. Trademark of ODVA.

dielectric Any insulating (nonconducting) material between two conductors.

dielectric constant (k) The ratio of the capacitance using the material in question as the dielectric, to the capacitance resulting when the material is replaced by air.

dielectric strength The voltage which an insulation can withstand before breakdown occurs. Usually expressed as a voltage gradient (such as volts per mil).

dielectric test A test in which a voltage higher than the rated voltage is applied for a specified time to determine the adequacy of the insulation under normal conditions.

digital Representation of data by discrete characters.

direct burial cable A cable installed directly in the earth, without a conduit.

direct current (DC) An electric current which flows in one direction.

direct current resistance (DCR) The resistance offered by any circuit to the flow of direct current.

direction of lay The lateral direction in which the strands of a conductor run over the top of the cable conductor as they recede from an observer looking along the axis of the conductor or cable. Also applies to twisted cable.

Glossary

dissipation factor The tangent of the loss angle of the insulating material. (Also referred to as loss tangent, $\tan \delta$, and approximate power factor.)

drain wire In a cable, the uninsulated wire in intimate contact with a shield to provide for easier termination of such a shield to ground.

drawing In wire manufacture, pulling the metal through a die or series of dies to reduce diameter to a specified size.

dual wall With heat shrink tubing, a construction having a double-layer construction, with the inner wall typically having an adhesive or meltable structure to bond and seal the tubing to the substrate.

duct An underground or overhead tube for carrying electrical cables.

duplex insulated In the thermocouple industry, a combination of dissimilar metal conductors of a thermocouple or thermocouple extension wire.

eccentricity Like concentricity, a measure of the center of a conductor's location with respect to the circular cross section of the insulation. Expressed as a percentage of displacement of the circle within the other.

ECTFE Ethylene chlorotrifluoroethylene.

EIA Electronic Industries Alliance.

elastomer A class of long-chain polymers capable of being crosslinked to produce elastic compounds, e.g. polychloroprene and ethylene propylene rubber.

electromagnetic Pertaining to the combined electric and magnetic fields associated with movements of electrons through conductors.

electromotive force (EMF) Pressure or voltage. The force which causes current to flow in a circuit.

electrostatic Pertaining to static electricity or electricity at rest. A constant intensity electric charge.

elongation The fractional increase in length of a material stressed in tension.

EMC Electromagnetic compatibility. No emission of interference exceeding FCC limits.

EMF See electromotive force.

EMI Electromagnetic interference.

EMP Electromagnetic pulse.

ends In braiding, the number of essentially parallel wires or threads on a carrier.

EPOS Abbreviation for electronic point-of-sale.

EPR Ethylene-propylene rubber, having similar physical properties to butyl rubber. The polymer is chemically cross-linked.

epoxy An adhesive used in the connector termination process.

EtherNet/IP An industrial automation protocol using CIP for upper layers and Ethernet for the lower layers. Trademark of ODVA.

ETFE Ethylene tetrafluoroethylene.

ETPC Abbreviation for electrolytic tough pitch copper. It has a minimum conductivity of 99.9%.

expanded diameter Diameter of shrink tubing as supplied. When heated, the tubing will shrink to its extruded diameter.

external interference The effects of electrical waves or fields which cause spurious signals other than the desired intelligence, e.g. noise.

extrusion A process of continuously applying an insulation over a conductor or jacket (rubber or plastic compounds).

FAA Federal Aeronautics Administration.

farad (F) Unit of capacitance whereby a charge of one coulomb produces a one volt potential difference.

fatigue resistance Resistance to metal crystallization which leads to conductors breaking from flexing.

feedback Transfer of some output energy of an amplifier to its input, so as to modify its characteristic.

FEP Fluorinated ethylene propylene.

FHDPE Foamed high-density polyethylene.

Fieldbus (1) A generic term for communication protocols used in industrial networks for instrumentation and control. (2) A specific set of protocols that includes Foundation Fieldbus and HSE (High-Speed Ethernet).

figure 8 cable An aerial cable configuration in which the conductors and the steel strand which supports the cable are integrally jacketed. A cross section of the finished cable approximates the figure "eight."

Glossary

filled cable A telephone cable construction in which the cable core is filled with a material that will prevent moisture from entering or passing through the cable.

filler (1) A material used in multiconductor cables to occupy large interstices formed by the assembled conductors. (2) An inert substance added to a compound to improve properties or decrease cost.

film A thin plastic sheet.

FIT® Alpha Wire registered trademark for shrinkable tubing and wire management products.

flame resistance The ability of a material not to propagate flame once the flame source is removed.

flammability The measure of the material's ability to support combustion.

flat cable Multiconductor cable arranged in a parallel type configuration manufactured with controlled tolerance spacing.

flat conductor A wire having a rectangular cross section as opposed to round or square conductors.

flat conductor cable A cable with several flat conductors.

FLC Fluorocopolymer insulating and/or jacketing compounds.

flex life The measurement of the ability of a conductor or cable to withstand repeated bending.

flexibility That quality of a cable or cable component which allows for bending under the influence of outside force, as opposed to limpness which is bending due to the cable's own weight.

foam polyethylene See cellular polyethylene.

foamed plastics Insulations having a cellular structure.

FPE Foam polyethylene.

FPP Foam polypropylene.

frequency Number of times an alternating current reverses itself in one second. Express in Hertz (hz), which is one cycle per second.

gang strip Simultaneous stripping all conductors in a flat or ribbon cable.

Gauge A term used to denote the physical size of a wire.

Giga- A numerical prefix denoting one billion (10^9).

gigahertz (GHz) A unit of frequency equal to one billion hertz.

ground A conducting connection between an electrical circuit and the earth or other large conducting body to serve as an earth thus making a complete electrical circuit.

ground fault A failure of transmission involving insulation-to-shield or insulation-to-ground wire.

halogen Elements such as fluorine, chlorine, bromine, and iodine that are highly reactive and can be harmful to people and animals.

hard-drawn copper wire Copper wire that has not been annealed after drawing.

harmonized Products meeting requirements of CENELEC for use in European Economic Community.

harness An arrangement of wires and cables, usually with many breakouts, which have been tied together or pulled into a rubber or plastic sheath, used to interconnect electric circuits.

hash mark stripe A non-continuous helical stripe applied to a conductor for identification.

heat distortion Distortion or flow of a material or configuration due to application of heat.

heat endurance The time of heat aging that a material can withstand before failing a specific physical test.

heat shock A test to determine stability of a material by sudden exposure to a high temperature for a short period of time.

helical stripe A continuous, colored, spiral stripe applied to a conductor for circuit identification.

henry (H) The unit of inductance.

hertz (Hz) The unit of frequency, expressing cycles per second.

high voltage Generally, a wire or cable with an operating voltage of over 600 volts.

hi-pot A test designed to determine the highest voltage that can be applied to a conductor without electrically breaking down the insulation.

hook-up wire A single insulated conductor used for low current, low voltage (usually under 1000 volts) applications within enclosed electronic equipment.

hygroscopic Readily absorbing and retaining moisture.

ICEA Insulated Cable Engineers Association.

Glossary

IDC Insulation displacement connector.

IEC International Electrotechnical Commission.

IEEE Institute of Electrical and Electronic Engineers.

IEEE-488 A standard for connecting test equipment. Also known as General-Purpose Interface Bus (GPIB).

impact strength A test for determining the mechanical punishment a cable can withstand without physical or electrical breakdown by impacting with a given weight, dropped a given distance, in a controlled environment.

impedance The total opposition that a circuit offers to the flow of alternating current or any other varying current at a particular frequency. It is a combination of resistance R and reactance X , measured in ohms.

IMSA International Municipal Signal Association.

index edge See reference edge.

inductance The property of a circuit or circuit element that opposes a change in current flow, thus causing current changes to lag behind voltage changes. It is measured in henrys.

inductive coupling Crosstalk resulting from the action of the electromagnetic field of one conductor on the other.

insulation A material having high resistance to the flow of electric current. Often called a dielectric in radio frequency (coaxial) cable.

insulation resistance The ratio of the applied voltage to the current between two electrodes in contact with a specific insulation.

Insulation A material having high resistance to the flow of electric current.

interconnecting cable The wiring between modules, between units, or the larger portions of a system.

interference Electrical or electromagnetic disturbances which introduce undesirable responses into other electronic equipment.

interstices Voids or valleys between individual strands in a conductor or between insulated conductors in a multiconductor cable during extreme flexing.

IPCEA Insulated Power Cable Engineers Association.

irradiated Exposure to high-energy radiation resulting in cross-linking of molecules.

irradiation In insulations, the exposure of the material to high energy emissions for the purpose of favorably altering the molecular structure.

ISA Originally, Instrument Society of America, now called International Society of Automation.

ISO International Standards Organization.

jacket An outer covering, usually non-metallic, mainly used for protection against the environment.

jumper cable A short flat cable interconnecting two wiring boards or devices.

kilo- (k) A numerical prefix denoting 1000 (10^3).

kilometer (km) 1000 meters or 3281 feet (0.621 miles).

kpsi Tensile strength in thousands of pounds per square inch.

kV kilovolt, 1000 volts

laminated tape A tape consisting of two or more layers of different materials bonded together.

lay The length measured along the axis of a wire or cable required for a single strand (in stranded wire) or conductor (in cable) to make one complete turn about the axis of the conductor or cable.

leakage current The undesirable flow of current through or over the surface of an insulation.

life cycle A test to determine the length of time before failure in a controlled, usually accelerated, environment.

limits of error The maximum deviation (in degrees or percent) of a thermocouple or thermocouple extension wire from standard EMF-temperature to be measured.

link The complete point-to-point communications path between transmitter and receiver.

litz A type of specialty cable designed to reduce AC losses in conductors from skin and proximity effects at high frequencies to make transformers and motors more efficient. Litz wire consists of individually insulated strands woven or twisted in a specific pattern so that each tends to occupy all possible positions in the cross section, thereby equalizing flux linkages and reactances.

Glossary

Loc-Trac® Alpha Wire's registered trademark for a zipper tubing closure track which does not require any sealants to keep it closed.

local area network (LAN)

A baseband or broadband interactive bidirectional communication system for voice, video or data use on a common cable medium.

longitudinal shield A tape shield, flat or corrugated, applied parallel to the axis of the core being shielded.

longitudinal shrinkage A term generally applied to shrink products denoting the discrete axial length lost through heating in order to obtain the recovered diameter.

loop resistance The total resistance of two conductors measured round trip from one end.

loss Energy dissipated without accomplishing useful work.

loss factor The product of the dissipation and dielectric constant of an insulating material.

low loss A cable that has relatively small power loss over long lengths.

low-loss dielectric An insulating material that has a relatively low dielectric loss, such as polyethylene or PTFE.

LSZH Low-smoke, zero halogen. An insulating material that contains no halogens or other potentially toxic materials and that generates very low levels of smoke when burned.

magnetic field The region within which a body or current experiences magnetic forces.

magnetic flux The rate of flow of magnetic energy across or through a surface (real or imaginary).

magnetic noise Caused by change in current level, e.g. AC powerline (creates magnetic field around that cable) this magnetic field causes the magnetic noise.

mastic A meltable coating used on the inside of some shrink products which, when heated, flows to encapsulate the interstitial air voids.

MCM Thousand circular mils.

mega- (M) A numerical prefix denoting 1,000,000 (10^6).

meter Unit of measurement, one meter equals 3.28 feet.

mho The unit of conductivity. The reciprocal of an ohm.

MHz Megahertz (one million cycles per second).

micro- A numerical prefix denoting one-millionth (10^{-6}).

microwave A short (usually less than 30 cm) electrical wave.

mil A unit used in measuring diameter of a wire or thickness of insulation over a conductor. One-one thousandth of an inch (.001").

milli- (m) Prefix meaning 1/1000 (10^{-3}).

millimeter One millimeter equals 0.03937 inches.

MIL-SPEC Military Specification. A document of the U.S. Government, issued to define a product that will be used in military end-use applications.

mismatch A termination having a different impedance than that for which a circuit or cable is designed.

modulation The coding of information onto the carrier frequency. Modulation means include (among others) amplitude, frequency, or phase pulse many forms of on-off digital coding.

modulus of elasticity The ratio of stress to strain in an elastic material.

moisture absorption The amount of moisture, in percentage, that a material will absorb under specified conditions.

moisture resistance The ability of a material to resist absorbing moisture from the air or when immersed in water.

monomer The basic chemical unit used in building a polymer.

MSHA Mine Safety and Health Administration.

MTW Machine tool wire.

multiconductor More than one conductor within a single cable complex.

mutual capacitance Capacitance between two conductors when all other conductors including ground are connected together and then regarded as an ignored ground.

nano- A numerical prefix denoting one-billionth (10^{-9}).

nanosecond One billionth of a second (10^{-9} second).

NBFU National Board of Fire Underwriters.

NBS National Bureau of Standards.

Glossary

NEC National Electrical Code. A consensus standard published by the National Fire Protection Association (NFPA) and incorporated in OSHA regulations.

NEMA National Electrical Manufacturers Association.

neoprene Thermosetting material, chemically known as polychloroprene, with excellent flame retarding and abrasion resisting qualities used as a jacketing material.

NFPA National Fire Protection Association, group that publishes the NEC.

noncontaminating PVC A polyvinylchloride formulation, which does not produce electrical contamination.

nylon A group of polyamide polymers which are used for wire and cable jacketing.

ODVA Formerly Open DeviceNet Vendors Association.

OFHC oxygen-free, high conductivity copper. It has no residual deoxidant, 99.95% minimum copper content and an average annealed conductivity of 101%.

ohm Unit of resistance such that a constant current of one ampere produces a force of one Volt.

Ohm's law 1) volts = current x resistance; 2) current = volts/ resistance; 3) resistance = volts/ current.

operating temperature range Indicates the range of temperature at which the cable or tubing can be used without loss of its physical properties.

OSHA Occupational Safety and Health Act.

outgassing Percentage of a gas released during the combustion of insulation or jacketing material.

overlap The amount the trailing edge laps over the leading edge of a tape wrap.

oxygen index Percentage of oxygen necessary to support combustion in gas mixture.

ozone Form of oxygen, produced by discharge of electricity into air and harmful to certain insulation.

pairing The union of two insulated single conductors through twisting.

PE Polyethylene.

percent conductivity Conductivity of a material expressed as a percentage of that of copper.

permittivity See dielectric constant.

phase 360 degrees represents one cycle. A fraction of one cycle is called a phase.

pick Distance between two adjacent crossover points of braid filaments. The measurement in picks per inch indicates the degree of coverage.

pico- (p) A numerical prefix denoting one-millionth of one-millionth (10^{-12}).

picofarad (pF) One trillionth of a farad (10^{-12}).

pitch In flat cable, the nominal distance between the index edges of two adjacent conductors.

pitch diameter Diameter of a circle passing through the center of the conductors in any layer of a multiconductor cable.

plastic deformation Change in dimensions under load that is not recovered when the load is removed.

plasticizer A chemical agent added to plastics to make them softer and more pliable.

plenum The air return path of a central air handling system, either ductwork or open space over a dropped ceiling.

plenum cable Cable approved by Underwriters Laboratories for installation in plenums without the need for conduit.

PLTC Power-limited tray cable.

point-to-point wiring Continuous conductors terminated at each end to circuit destinations.

polychloroprene Chemical name of neoprene.

polyester Polyethylene terephthalate, which is used extensively in the production of a high-strength moisture-resistant film used as a cable core wrap.

polyethylene A family of insulations derived from the polymerization of ethylene gas and characterized by outstanding electrical properties, including high IR, low dielectric constant, and low dielectric loss across the frequency spectrum. Mechanically rugged, it resists abrasion and cold flow.

polyhalocarbon A general name for polymers containing halogen atoms. The halogens are fluorine, chlorine and bromine.

polymer A material of high molecular weight formed by the chemical union of monomers.

Glossary

polyolefin A family of thermoplastics based upon the unsaturated hydrocarbons known as olefins. When combined with butylene or styrene polymers, they form compounds such as polyethylene and polypropylene.

polyurethane A family of flexible, abrasion resistant jackets used for Xtra-Guard® 2 harsh environment cables.

polyvinylchloride A general purpose family of insulations whose basic constituent is polyvinylchloride or its copolymer with vinyl acetate. Plasticizers, stabilizers, pigments and fillers are added in lesser quantity to improve mechanical and/or electrical properties of this material.

porosity Multiple air voids in an insulation or jacket wall.

potting The sealing of a cable termination or other component with a liquid which thermosets into an elastomer.

power Rate at which work is done in moving current, measured in watts. Power = Pressure x Current.

power factor The ratio of resistance to impedance. The ratio of the actual power of an alternating current to apparent power. Mathematically, the cosine of the angle between the voltage applied and the current resulting.

primary insulation The first layer of nonconductive material applied over a conductor, whose prime function is to act as electrical barrier (insulation).

PROFIBUS An industrial automation fieldbus.

propagation delay Time required for an electrical wave to travel between two points on a transmission line.

propagation time Time required for a wave to travel between two points on a transmission line.

propagation velocity See Velocity of Propagation.

psi Pound per square inch.

PTFE Polytetrafluoroethylene.

pulling eye A device fastened to a cable to which a hook may be attached in order to pull the cable into or from a duct.

pulse cable A type of coaxial cable constructed to transmit repeated high voltage pulses without degradation.

put-up and packaging The method of packaging product. May be expressed in units or footage. May show 4 foot lengths, spools, coils or long lengths of wire, cable and tubing products.

PV Photovoltaic.

PVC Polyvinylchloride.

PVDF Polyvinylidene fluoride.

QPL Qualified parts list.

quad A four-conductor cable.

rad The unit of radian dose which is absorbed, equal to .01 joule/kilogram.

radio frequency One suitable for radio transmission, above 104 Hz and below 3 GHz.

rated temperature The maximum temperature at which an electric component can operate for extended periods without loss of its basic properties.

rated voltage The maximum voltage at which an electric component can operate for extended periods without undue degradation or safety hazard.

REACH Registration, Evaluation and Authorization of Chemical Substances. An EU framework for regulating the production and use of chemical substances.

reactance The opposition offered to the flow of alternation current by inductance or capacitance of a component or circuit.

recovered diameter Diameter of shrinkable products after heating has caused it to return to its extruded diameter.

reference edge Edge of cable or conductor from which measurements are made. Sometimes indicated by a thread, stripe, printing or other identifying mark. Conductors are usually identified by their sequential position from the reference edge, with number one conductor closest to the edge.

reference junction The junction of a thermocouple which is at a known reference temperature. Also known as the "cold" junction, it is usually located at the emf measuring device.

reflection loss The part of a signal which is lost due to reflection of power at a line discontinuity.

reflow soldering The process of connecting two solder-coated conductive surfaces by remelting of the solder to cause fusion.

repeater A transmitter and receiver combination used to regenerate a signal along the communications path.

Glossary

resin A synthetic organic material formed by the union (polymerization) of one or more monomers with one or more acids.

resistance A measure of the difficulty in moving electrical current through a medium when voltage is applied. It is measured in ohms.

retractile cord A cable that returns by its own stored energy from an extended condition to its original contracted form.

RF Radio frequency.

RFI Radio frequency interference.

RG/U Radio Government, Universal. RG is the military designation for coaxial cable in MIL-DTL-17 and U stands for "general utility."

ribbon cable A flat cable of individually insulated conductors lying parallel and held together by means of adhesive film laminate.

ridge marker One or more ridges running laterally along the outer surface of an insulated wire for purposes of identification.

ringing out The process of locating or identifying specific conductive paths by means of passing current through selected conductors.

RJ-11 A 6-position modular plug and jack connector system.

RJ-45 An 8-position modular plug and jack connector system, widely used in local- and wide-area networks.

Rockwell hardness A test for determining hardness in which a hardened steel ball or diamond point is pressed into the material under test.

RoHS Restriction of Hazardous Substances. A regulatory framework for restricting the amounts of hazardous substances, including lead, mercury, cadmium, hexavalent chromium, PBB, and PBDE, in materials.

root mean square (RMS) The effective value of an alternating current or voltage.

rope lay Cable composed of central core surrounded by one or more layers of helically laid groups of wires. Usually extremely flexible.

routing The path followed by a cable or conductor.

RS-232 A serial communications protocol using single-ended signaling for connecting data equipment at speeds up to 230.4 kb/s.

RS-422 A serial communications protocol using differential signaling for connecting equipment, at speeds to 10 Mb/s.

RS-423 A serial communications protocol using single-ended signaling for connecting data terminal equipment to data circuit-terminating equipment.

RS-485 A serial communications protocol using balanced signaling for connecting data terminal equipment to data circuit-terminating equipment, at speeds to 10 Mb/s over long distances and in noisy environments.

SAE Society of Automotive Engineers.

self-extinguishing The characteristic of a material whose flame is extinguished after the igniting flame is removed.

semiconductor A material that has a resistance characteristic between that of insulators and conductors.

semirigid PVC A hard semi-flexible polyvinylchloride compound with low plasticizer content.

separator A layer of insulating material such as textile, paper, polyester, etc. Used to improve stripping qualities, flexibility, mechanical or electrical protection to the components.

serve A filament or group of filaments such as fibers or wires, wound around a central core.

sheath The outer covering or jacket of a multiconductor cable.

shelf life Length of time under specified conditions that a material retains its usability.

shield A metallic layer, commonly aluminum or copper, of tape, braid or spiral wrapped wire construction. Its primary purpose is to prevent electrostatic or electromagnetic interference between adjacent wires and external sources.

shield coverage The physical area of a cable that is actually covered by the shielding material and is expressed in percent.

shield effectiveness The relative ability of a shield to screen out undesirable signals.

shrink ratio The ratio of shrinkage of tubing inside diameter from the expanded size to the fully recovered dimension.

shrink temperature That temperature which effects complete recovery of a shrinkable product from the expanded state.

Glossary

shrink tubing Tubing which has been extruded, cross-linked and non cross-linked, and mechanically expanded which when reheated will return to its original diameter.

signal A current used to convey information, either digital, analog, audio or video.

signal cable A cable designed to carry current of usually less than one ampere per conductor.

simplex Mode of data transmission in one direction only. Usually on a two-wire facility.

sintering A method of heat sealing. Fusion of a spirally applied tape wrap jacket by the use of high heat to a homogenous continuum. Usually employed for fluorocarbon, non-extrudable materials.

SIS XLP switchboard wire.

skin effect The phenomenon in which the depth of penetration of electric currents into a conductor decreases as the frequency increases.

sleeving A braided, extruded or woven tube.

SNR Signal-to-noise ratio.

soldering sleeves Shrinkable tubing with a solder preform used for highest reliability soldering connections or shield grounding.

solid conductor A conductor consisting of a single wire.

span In flat cables, the distance from the reference edge of the first conductor to the reference edge of the last conductor (in cables having flat conductors), or the distance between the centers of the first and last conductors (in cables having round conductors), expressed in inches or centimeters.

spark test A test designed to locate imperfections (usually pin-holes) in the insulation of a wire or cable by application of a voltage for a very short period of time while the wire is being drawn through the electrode field.

specific gravity The ratio of the density (mass per unit volume) of a material to that of water.

specific inductive capacity (SIC) See dielectric constant.

spiral wrap The helical wrap of a material over a core.

splice A mechanical device or fusion process that permanently bonds two fibers together without a connector producing extremely low loss.

spool Circular container on which wire is wound for storage or transit normally refers to sizes smaller than 18" in diameter.

stability factor The difference between the percentage power factor at 80 volts/mil and at 40 volts/mil measured on wire immersed in water at 75°C for a specified time.

static condition Used to denote the environmental conditions of an installed cable rather than the conditions existing during cable installation.

STP Shielded twisted pair cable.

strand A single uninsulated wire.

stranded conductor A conductor composed of single solid wires twisted together, either singly or in groups.

strip force The force required to remove a small section of insulating material from the conductor it covers.

structural return loss (SRL) Expresses the amount of signal lost in negative terms, and occurs when signals reflect back to points of transmission.

suggested working voltage AC voltage that can be applied between adjacent conductors.

Supra-Shield® Alpha Wire's trade name for foil/braid combination used for maximum shielding effectiveness.

surface resistivity The resistance of a material between two opposite sides of a unit square of its surface. It is usually expressed in ohms.

surge A temporary, large increase in the voltage or current in an electric circuit or cable.

sweep test A method to determine the frequency response of a cable, by generating an RF voltage whose frequency is varied at a rapid constant rate over a given range.

switchboard cable The cable used within and between the central office main frames and the switchboard.

tank test A voltage dielectric test in which the test sample is submerged in water and voltage is applied between the conductor and water as ground.

Glossary

tape wrap A spirally applied tape over an insulated or uninsulated wire.

TC Tray cable.

TC-ER Tray cable, extended run.

tear strength The force required to initiate or continue a tear in a material under specified conditions.

temperature coefficient of resistance The amount of resistance change of material per degree of temperature rise.

temperature rating The maximum and minimum temperature at which an insulating material may be used in continuous operation without loss of its basic properties.

Tempest Classified procedure which details the complex measurement of the combined reduction of all electromagnetic emissions from specified equipment.

tensile strength The pull stress required to break a given specimen.

TFE Polytetrafluoroethylene.

thermal shock A test to determine the ability of a material to withstand heat and cold by subjecting it to rapid and wide changes in temperature.

thermocouple A device for measuring temperature, at the point where two dissimilar metals are joined, and EMF output is generated when heated.

thermocouple element A thermocouple designed to be used as part of an assembly, but without associated parts such as the terminal block, connecting head, or protecting tube.

thermocouple extension cable A cable comprised of one or more twisted thermocouple extension wires under a common sheath.

thermocouple extension wire A pair of wires of dissimilar alloys having such EMF-temperature characteristics complimenting the thermocouple which is intended to be used, such that when properly connected allows the EMF to be faithfully transmitted to the reference junction.

thermocouple wire (grade) A pair of wires of dissimilar alloys having EMF-temperature characteristics calibrated to higher temperature levels than the extension type of thermocouple wire. Unlike the thermocouple extension wire, this wire may be employed as the thermocouple hot junction in addition to serving as the entire wire connection between hot and cold reference junctions.

thermoplastic A material which softens when heated or reheated and becomes firm on cooling.

thermoset A material which hardens or sets by heat, chemical or radiation cross-linking techniques and which, once set, cannot be resoftened by heating.

THHN 90°C, 600 volt, nylon jacketing building wire for dry locations.

THWN 75°C, 600 volt, nylon jacketed building wire for wet and dry locations.

tinned copper Tin coating added to copper to aid in soldering and inhibit corrosion.

topcoat conductor A conductor construction in which bare copper wires are first stranded and then coated with tin.

transformer A device for converting AC current from one voltage to another either “stepped up” or “stepped down.”

transmission cable Two or more transmission lines. If the structure is flat, it is sometimes called flat transmission cable to differentiate it from a round structure such as a jacketed group of coaxial cables. See transmission line.

transmission line A signal-carrying circuit with controlled electrical characteristics used to transmit high-frequency or narrow-pulse signals.

transmission loss The decrease or loss in power during transmission of energy from one point to another. Usually expressed in decibels.

tray A cable tray system is a unit or assembly of units or sections, and associated fittings, made of metal or other noncombustible materials forming a rigid structural system used to support cables. Cable tray systems (previously termed continuous rigid cable supports) include ladders, troughs, channels, solid bottom trays, and similar structures.

tray cable A factory-assembled multiconductor control, signal and power cable specifically approved under the National Electrical Code for installation of trays.

triad A group of 3 insulated conductors twisted together without (or with) a sheath overall. Usually color coded for identification. Also called triplex.

triaxial cable A cable construction having three coincident axes, such as conductor, first shield and second shield all insulated from one another.

Glossary

tubing A tube of extruded non-supported plastic or metallic material.

twinning Synonymous with pairing.

UF Thermoplastic underground feeder and branch circuit cable.

UHF Ultra high frequency, 300 to 3000 MHz.

UL Underwriters Laboratories, a nonprofit, independent organization, which operates a listing service for electrical and electronic materials and equipment.

UN Ungrounded neutral (refers to a type of power system).

unbalanced circuit A transmission line in which voltages on the two conductors are unequal with respect to ground; e.g. a coaxial cable.

unilay A conductor constructed with a central core surrounded by more than one layer of helically-laid strands, with all layers having a common length and direction of lay.

UTP Unshielded twisted pair cable.

UV Ultraviolet.

VDE German Society of Engineers that establishes standards and testing requirements.

velocity of propagation The speed of an electrical signal down a length of cable compared to speed in free space expressed as a percent. It is the reciprocal of the square root of the dielectric constant of the cable insulation.

VFD Variable-frequency drive.

VHF Very high frequency, 30 to 300 MHz.

volt A unit of electrical pressure. One volt is the electrical pressure that will cause one ampere of current to flow through one ohm of resistance.

voltage The term most often used in place of electromotive force, potential, potential difference, or voltage drop to designate the electric pressure that exists between two points and is capable of producing a current when a closed circuit is connected between two points.

voltage drop The amount of voltage loss from original input to point of electrical device.

voltage rating The highest voltage that may be continuously applied to a wire in conformance with standards or specifications.

voltage standing wave ratio (VSWR) The ratio of the maximum effective voltage to the minimum effective voltage measured along the length of a mismatched radio frequency transmission line.

volume resistivity (specific insulation resistance) The electrical resistance between opposite faces of a 1 cm cube.

VSWR Voltage standing wave ratio.

vulcanize To fuse under heat and pressure.

wall thickness The thickness of the applied insulation or jacket material.

water absorption Water by percent weight absorbed by a material after a given immersion period.

Watt (W) A unit of electric power. The watt is the power required to do work at the rate of one joule per second.

waveguide Hollow pipe (round or rectangular) used as transmission line for the propagation of microwaves.

wavelength The distance, measured in the direction of propagation, of a repetitive electrical pulse or waveform between two successive points.

wicking The longitudinal flow of a liquid in a wire or cable due to capillary action.

wire A slender rod or filament of drawn metal.

WTTC Wind turbine tray cable.

XLPE Cross-linked polyethylene.

Xtra-Guard® The Alpha Wire trade name for cable constructions designed for use in virtually any type of environment.

yield strength The minimum stress at which a material will start to physically deform without further increase in load.

Zipper Tubing™ Alpha Wire's trade name for a harnessing/jacketing material containing a zippertrack type closure. The zipper arrangement allows installation with no need to disconnect previously wired schemes for its installation. (See Loc-Trac®).

Part Number Index

Part No.	Page	Part No.	Page	Part No.	Page	Part No.	Page
1012405	222	1231	519	1651	385	1895C	309
1012407	222	1232	519	1653	385	1895L	306
1012409	222	1233	519	1655	385	1896C	309
1064	311	1233/2	519	1702	327	1896L	306
1065	311	1234	519	1703	327	1896/*C	309
1067	311	1235	519	1705	327	1896/*L	306
1069	311	1239	519	1706	327	1897C	309
1072	311	1240	519	1709	327	1898C	309
1075	311	1241	519	1710	327	1898/**	309
1079	311	1242	519	1712	327	1899C	309
1085	311	1242/4	519	1712	329	1899/*C	309
1101	368	1243	313	1713	329	1931	272
1102	368	1243/2C	361	1715	329	1932	272
1115	368	1243/3C	316	1716	329	1932/3	272
1116	368	1243/4	313	1717	329	1933	272
1120	368	1243/5	313	1719	329	1933/3	272
1121	368	1274	311	1721	329	1934	272
1122	368	1275	311	1723	329	1934/**	272
1131C	340	1277	311	1726	329	1935	272
1132C	340	1279	311	172619	384	1935/**	272
1133C	340	12819	399	1728	329	1936	272
1134C	340	12819UL	399	1735	323	1936/**	272
1135C	340	1282	311	1736C	323	1937	272
1136C	340	1292C	317	1737C	323	1937/**	272
1138C	340	1293C	317	1738C	323	1938/3	272
1139C	340	1294C	317	1741C	323	1941/**	273
1149C	340	1295C	317	1742C	323	1942/**	273
1172C	308	1296C	317	1743C	323	1943/**	273
1172L	306	1297C	317	1745	323	1951/3	273
1173C	308	1298C	317	1746C	323	1951/3T	273
1173L	306	1299C	317	1747C	323	1952/3	273
1174C	308	1299/**	317	1747/4C	323	1952/3T	273
1174L	306	13001	399	1748C	323	1953/3	273
1175C	308	1300C	340	1749C	323	1953/3T	273
1175L	306	1302C	340	1750	324	275001801	257
1176C	308	1304C	340	1751	324	275001802	257
1176L	306	1305C	340	1760	324	275002001	257
1177C	308	1306C	340	1761	324	275002002	257
1177L	306	1307C	340	1771	328	275002003	257
1178C	308	1308/11C	340	1772	328	275002004	257
1178L	306	1309C	340	1775C	323	275002201	257
1179C	308	1310C	340	1793C	311	275002202	257
1179L	306	1313C	340	1805	404	275002203	257
11807	399	1317C	340	1806	404	275002204	257
1180C	308	1318C	340	1807	404	275002402	257
1180L	306	1319C	340	1808	404	201219	386
1181C	308	13207	399	181419	388	201419	386
1181/15C	308	1320C	340	181619	388	201619	386
1181/20C	308	1322C	340	181807	388	201807	386
1181/25C	308	1323C	340	181819	388	201819	386
1181/30C	308	1324C	340	182019	388	202007	386
1181/40C	308	1325C	340	182219	388	202207	386
1181/50C	308	1327C	340	182407	388	20RC2S06	256
1181/60C	308	1327/19C	340	182419	388	20RC3S06	256
1212C	317	1450	330	182607	388	20RC4S06	256
1213C	317	1450/16	330	1826C	313	2132	520
1214C	317	1451/16	330	1827C	313	2138	520
1215C	317	1454	330	1828C	313	2140	520
1216C	317	1550	390	1850	384	2142	520
1217C	317	1551	390	1851	384	2144	520
1218C	317	1553	390	1852	384	2146	520
1219C	317	1555	390	1853	384	2148	520
1219/10C	317	1557	390	1854	384	2150	520
1219/12C	317	1559	390	1854/19	384	2152	520
1219/15C	317	1560	390	1855	384	2160	521
1219/20C	317	1561	390	1855/19	384	2162	521
1219/25C	317	1561/24	390	1856	384	2163	521
1219/37C	317	1563	390	1856/19	384	2164	521
1219/40C	317	1565	390	1857	384	2166	521
1219/50C	317	1579	385	1857/19	384	2167	521
1221	519	1604	369	1858/19	384	2168	521
1222	519	1606	369	1859/19	384	2170	521
1223	519	1608	369	1891/3C	310	2171	521
1224	519	1632	405	1891C	310	2171/1	521
1229	519	1635	405	1892/3C	310	2172	521
1230	519	1636	405	1892C	310	2173	521

Part Number Index

Part No.	Page	Part No.	Page	Part No.	Page	Part No.	Page
2174	521	2473	348	25139/12	70	25434	60
2175	521	24RC2S06	256	25152	64	25435	60
2175/1	521	24RC3S06	256	25153	64	25440/**	63
2176	521	24RC4S06	256	25154	64	25439	60
2177	521	25002	58	25156	64	25439/**	60
2178	521	25003	58	25158	64	25440/**	63
2179	521	25004	58	25160	64	25442	60
2180	521	25006	58	25160/**	64	25443	60
2181	521	25008	58	25162	65	25444	60
2182	521	25010	58	25162/1	65	25445	60
2191	522	25010/**	58	25163	65	25449	60
2193	522	25012	58	25163/1	65	25449/12	60
2194	522	25013	58	25164	65	25450/**	63
2195	522	25014	58	25166	65	25450/3	63
2196	522	25016	58	25168	65	25452	68
2197	522	25018	58	25170	65	25453	68
2198	522	25020	58	25170/**	65	25456	68
22007	402	25020/**	58	25172	65	25459	68
2211C	343	25052	58	25172/1	65	25459/**	68
2212C	343	25053	58	25173	65	25462	61
2213C	343	25054	58	25173/1	65	25463	61
2214C	343	25056	58	25174	65	25464	61
2215C	343	25058	58	25176	65	25466	61
2216C	343	25060	58	25178	65	25468	61
2219C	343	25060/**	58	25180	65	25470	61
2219/**	343	25062	59	25180/**	65	25470/**	61
22207	402	25062/1	59	25192	61	25481	67
22407	402	25063	59	25193	61	25482	67
2241C	343	25063/1	59	25194	61	25483	67
2242C	343	25064	59	25196	61	25484	67
2243C	343	25066	59	25198	61	25485	67
2244C	343	25068	59	25199/**	61	25486	67
2245C	343	25070	59	25271	69	25489	67
2246C	343	25070/**	59	25272	69	25489/**	67
2249C	343	25072	59	25273	69	25491	67
2249/12C	343	25072/1	59	25274	69	25492	67
2249/19C	343	25073	59	25275	69	25493	67
2254	319	25073/1	59	25276	69	25494	67
2254/**	319	25074	59	25279	69	25495	67
2256	319	25076	59	25279/**	69	25496	67
2256/**	319	25078	59	25292	70	25499	67
2258	319	25080	59	25293	70	25499/**	67
2258/**	319	25080/**	59	25296	70	25522	66
2260	319	25092	61	25299	70	25523	66
2260/3	319	25093	61	25362	62	25524	66
22807	402	25094	61	25362/1	62	25525	66
22RC2S06	256	25096	61	25363	62	25527	66
22RC3S06	256	25098	61	25363/1	62	25529	66
22RC4S06	256	25100	61	25364	62	25532	66
2400C	314	25100/**	61	25366	62	25533	66
2401C	314	25102	64	25368	62	25534	66
2402C	314	25103	64	25370	62	25535	66
2403C	314	25104	64	25370/**	62	25537	66
2404C	314	25106	64	25372	68	25539	66
2411C	314	25108	64	25373	68	25539/**	66
2412C	314	25110	64	25376	68	25542	66
2413C	314	25110/**	64	25379	68	25543	66
2414C	314	25112	64	25379/12	68	25544	66
2421C	314	25113	64	25382	62	25545	66
2422C	314	25114	64	25382/1	62	25547	66
2423C	314	25116	64	25383	62	25549	66
2424C	314	25118	64	25383/1	62	25549/12	66
2432C	314	25120	64	25384	62	2803/2	333
2433C	314	25120/**	64	25386	62	2804/**	333
2442C	315	25121	69	25388	62	2811	332
2444C	315	25122	69	25390	62	2811/**	332
2460C	316	25123	69	25390/**	62	2814/**	332
2463C	361	25124	69	25422	60	2817/**	332
2463L	307	25125	69	25423	60	2819	333
2465C	316	25126	69	25424	60	2819/**	333
2466C	361	25129	69	25427	60	2820	333
2466L	307	25129/**	69	25429	60	2820/**	333
2467C	364	25132	70	25429/12	60	2821	334
2468	349	25133	70	25430/**	63	2821/**	334
2471	348	25136	70	25432	60	2824	334
2472	348	25139	70	25433	60	2824/**	334

Part Number Index

Part No.	Page	Part No.	Page	Part No.	Page	Part No.	Page
2826	335	32007	398	3492C	354	35180/15	76
2826/**	335	3201	321	3493C	354	35192	73
2827	334	32019	398	3494C	354	35193	73
2827/**	334	3202	324	3495C	354	35194	73
2829/**	335	3203	324	3496C	354	35196	73
2831	331	3210	324	3498C	354	35198	73
2831/**	331	3211	324	3500/**	354	35199/**	73
2834	331	3212	324	35002	72	3520	420
2834/**	331	3213	324	35003	72	35272	78
2837/**	331	3220	324	35004	72	3530	419
2840/7	398	3221	324	35006	72	3530/7	419
2841/**	398	3222	324	35008	72	3531	419
2842/**	398	3223	324	35010	72	3531/7	419
2843/**	398	3230	322	35010/15	72	3532	419
2844/**	398	3231	322	3505	420	3532/7	419
2845/**	398	3232	322	35052	72	3533	419
2853/1	400	3233	322	35053	72	3533/7	419
2854/1	400	3240	322	35054	72	35362	74
2855/1	400	3241	322	35056	72	35363	74
2856/1	400	3242	322	35058	72	35364	74
2857/1	400	3243	322	35060	72	35366	74
286	421	3245	322	35060/15	72	35368	74
289	421	3246	322	35062	72	35370	74
295	421	3247	322	35063	72	35370/**	74
296	421	3248	322	35064	72	35372	77
297	421	3250	381	35066	72	35373	77
298	421	3251	381	35068	72	35376	77
299	421	3252	381	35070	72	35382	74
299/**	421	3253	381	35070/15	72	35383	74
301441	389	3254	381	35072	72	35384	74
301619	389	3302	320	35073	72	35386	74
301626	389	3303	320	35074	72	35388	74
301816	389	3304	320	35076	72	35390	74
302010	389	3306	320	35078	72	35390/**	74
302201	389	3308	320	35080	72	3540	419
302207	389	3310	320	35080/15	72	3540/7	419
302407	389	3312	320	3510	420	3541	419
3047	380	3315	320	35102	76	3541/7	419
3048	380	3320	320	35103	76	3542	419
3049	380	33201	398	35104	76	3542/7	419
3050	380	33219	398	35106	76	3543	419
3050/1	380	3335	321	35108	76	35430/**	75
3051	380	3336	321	35110	76	35440/**	75
3051/1	380	3337	321	35110/15	76	35450/**	75
3053	380	3405	326	35121	78	35452	77
3053/1	380	3408	326	35122	78	35453	77
3055	380	3410	326	35123	78	35462	73
3055/1	380	3412	326	35124	78	35463	73
3057	380	3415	326	35125	78	35464	73
3057/1	380	3420	326	35126	78	35466	73
3070	383	3430	326	35129	78	35468	73
3071	383	3444	326	3515	420	35470	73
3073	383	3446	326	35152	76	35470/**	73
3075	383	3450	326	35153	76	35481	77
3077	383	3452	326	35154	76	35482	77
3079	383	3463	336	35156	76	35483	77
3080	383	3464C	336	35158	76	35484	77
3081	383	3465C	336	35160	76	35485	77
3111000	412	3466C	336	35160/15	76	35491	77
3111265	412	3467C	336	35162	76	35492	77
3111441	412	3468C	336	35162/1	76	35493	77
3111626	412	3469C	336	35163	76	35494	77
3111816	412	3470C	336	35163/1	76	3550	419
3112010	412	3470/**	336	35164	76	3550/14	419
3112133	412	3472C	350	35166	76	3551	419
3114133	412	3474C	350	35168	76	3551/16	419
3116133	412	3475C	350	35170	76	3553	419
3118133	412	3476C	350	35170/15	76	3580/**	371
3131000	413	3477C	350	35172	76	3582/**	374
3131265	413	3480C	350	35172/1	76	3583/**	371
3131441	413	3480/**	350	35173	76	3585/**	372
3131626	413	3483	337	35173/1	76	3590/**	373
3131816	413	3484C	337	35174	76	390001	406
3136133	413	3488C	337	35176	76	390002	406
3138133	413	3489C	337	35178	76	390004	406
3200	324	3490/25C	337	35180	76	390262	410

Part Number Index

Part No.	Page	Part No.	Page	Part No.	Page	Part No.	Page
390462	410	422601	381	45133	93	45388	84
390645	410	422607	381	45134	93	45390	84
390662	410	422801	381	45135	93	45390/**	84
390845	410	422807	381	45136	93	45422	82
390862	410	45002	80	45139	93	45423	82
390897	410	45003	80	45139/**	93	45424	82
391000	406	45004	80	45152	86	45425	82
391040	410	45006	80	45153	86	45427	82
391045	410	45008	80	45154	86	45429	82
391097	410	45010	80	45156	86	45430/**	85
391099	410	45010/**	80	45158	86	45432	82
391245	410	45012	80	45160	86	45433	82
391250	410	45013	80	45160/**	86	45434	82
391259	406	45014	80	45162	87	45435	82
391262	410	45016	80	45162/1	87	45437	82
391265	406	45018	80	45163	87	45439	82
391275	410	45020	80	45163/1	87	45440/**	85
391297	410	45020/**	80	45164	87	45442	82
391440	409	45031	89	45166	87	45443	82
391441	406	45032	89	45168	87	45444	82
391445	409	45052	80	45170	87	45445	82
391450	409	45053	80	45170/**	87	45447	82
391462	409	45054	80	45172	87	45450/**	85
391475	409	45056	80	45172/1	87	45451	91
391497	409	45058	80	45173	87	45452	91
391499	409	45060	80	45173/1	87	45453	91
391626	406	45060/**	80	45174	87	45454	91
391640	409	45062	81	45176	87	45455	91
391645	409	45062/1	81	45178	87	45456	91
391650	409	45063	81	45180	87	45459	91
391662	409	45063/1	81	45180/**	87	45459/**	91
391675	409	45064	81	45192	83	45462	83
391697	409	45066	81	45193	83	45463	83
391699	409	45068	81	45194	83	45464	83
391816	406	45070	81	45196	83	45466	83
391840	409	45070/**	81	45198	83	45468	83
391845	410	45072	81	45199/**	83	45470	83
391850	409	45072/1	81	45271	92	45470/**	83
391862	409	45073	81	45272	92	45481	90
391875	409	45073/1	81	45273	92	45482	90
391897	409	45074	81	45274	92	45483	90
392010	406	45076	81	45275	92	45484	90
392040	409	45078	81	45276	92	45485	90
392045	409	45080	81	45279	92	45486	90
392050	409	45080/**	81	45279/**	92	45489	90
392062	409	45092	83	45291	93	45489/**	90
392075	409	45093	83	45292	93	45491	90
392097	409	45094	83	45293	93	45492	90
392207	406	45096	83	45294	93	45493	90
392240	409	45098	83	45295	93	45494	90
392245	409	45100	83	45296	93	45495	90
392250	409	45100/**	83	45299	93	45496	90
392259	406	45102	86	45299/**	93	45499	90
392262	409	45103	86	45362	84	45499/**	90
392275	409	45104	86	45362/1	84	45522	88
392297	409	45106	86	45363	84	45523	88
394133	406	45108	86	45363/1	84	45524	88
396133	406	45110	86	45364	84	45525	88
398133	406	45110/**	86	45366	84	45527	88
39X1260	411	45112	86	45368	84	45529	88
39X1460	411	45113	86	45370	84	45529/12	88
39X1620	411	45114	86	45370/**	84	45532	88
39X1635	411	45116	86	45371	91	45533	88
39X1645	411	45118	86	45372	91	45534	88
39X1660	411	45120	86	45373	91	45535	88
39X1825	411	45120/**	86	45374	91	45537	88
39X2015	411	45121	92	45375	91	45539	88
39X2020	411	45122	92	45376	91	45539/12	88
39X2025	411	45123	92	45379	91	45542	88
39X2205	411	45124	92	45379/**	91	45543	88
39X2215	411	45125	92	45382	84	45544	88
39X2220	411	45126	92	45382/1	84	45545	88
421626	381	45129	92	45383	84	45547	88
421816	381	45129/**	92	45383/1	84	45549	88
422001	381	45131	93	45384	84	460001	382
422010	381	45132	93	45386	84	460219	382

Part Number Index

Part No.	Page	Part No.	Page	Part No.	Page	Part No.	Page
460419	382	5066C	34	5176C	46	5318C	47
460619	382	5068C	34	5178C	46	531B	267
460819	382	5070C	34	5180C	46	531F	267
461019	382	5070/**	34	5180/**	46	532	267
461219	382	5072C	34	5192C	39	5320C	47
461265	382	5072/1C	34	5193C	39	5320/4C	47
461419	382	5073C	34	5194C	39	5321C	47
461626	382	5073/1C	34	5196C	39	5322C	47
461626	382	5074C	34	5198C	39	5323C	47
461816	382	5076C	34	5199/**	39	5324C	47
461816	382	5078C	34	5201C	35	5325C	47
468	261	507F	262	5202C	35	5326C	47
470	261	507F	262	5203C	35	532B	267
472	261	5080C	34	5204C	35	532F	267
474	261	5080/**	34	5206C	35	533	267
492100	492	508F	262	5210/2C	35	5330C	56
492150	492	508F	262	5211C	35	5331C	56
492200	492	5092C	38	5212C	35	5332C	56
492250	492	5093C	38	5213C	35	5333C	56
492350	492	5094C	38	5214C	35	5334C	56
492413	492	5096C	38	5214/25C	35	5335C	56
492500	492	5098C	38	5215C	35	5336C	56
492625	492	5100C	38	5216C	35	534	267
492750	492	5100/**	38	521F	264	5340C	56
493100	493	5102C	45	521F	264	5340/2C	56
493101	493	5103C	45	5220/2C	35	5341C	56
493102	493	5104C	45	5220C	35	5342C	56
493103	493	5106C	45	5221C	35	5344C	56
493110	493	5108C	45	5222C	35	5345C	56
493118	493	511	264	5223C	35	5346C	56
5002C	33	5110C	45	5224C	35	534B	267
5003C	33	5110/**	45	5224/25C	35	535	267
5004C	33	5112C	44	5225C	35	5350/4C	56
5006C	33	5113C	44	5226C	35	5350C	56
5008C	33	5114C	44	523	264	5351C	56
501	262	5116C	44	5261C	50	5351/9C	56
5010C	33	5118C	44	5262C	50	5353C	56
5010/**	33	512	264	5263C	50	5354C	56
5012C	32	5120C	44	5264C	50	5355C	56
5013C	32	5120/**	44	5265C	50	535B	267
5014C	32	5121C	55	5266C	50	5362C	40
5016C	32	5122C	55	5269C	50	5362/1C	40
5018C	32	5123C	55	5269/**	50	5363C	40
501B	262	5124C	55	5271C	54	5363/1C	40
502	262	5125C	55	5272C	54	5364C	40
5020C	32	5126C	55	5273C	54	5366C	40
5020/**	32	5129C	55	5274C	54	5368C	40
5021C	50	5129/**	55	5275C	54	536F	267
5022C	50	513	264	5276C	54	537	268
5023C	50	5132C	55	5279C	54	5370C	40
5024C	50	5133C	55	5279/**	54	5370/**	40
5025C	50	5136C	55	5282C	51	5373C	53
5026C	50	5139C	55	5283C	51	5376C	53
5029/15C	50	5139/27C	55	5286C	51	537B	268
502B	262	514	264	5289C	51	537B	268
503	262	5152C	45	5289/12C	51	538	268
5032C	51	5153C	45	5292C	55	5382C	40
5033C	51	5154C	45	5293C	55	5382/1C	40
5036C	51	5156C	45	5296C	55	5383C	40
5039C	51	5158C	45	5299C	55	5383/1C	40
5039/12C	51	5160C	45	5299/19C	55	5384C	40
505	262	5160/**	45	5300C	47	5386C	40
5052C	33	5162C	46	5301C	47	5388C	40
5053C	33	5162/1C	46	5302C	47	5390C	40
5054C	33	5163C	46	5303C	47	5390/**	40
5056C	33	5163/1C	46	5304C	47	540	268
5058C	33	5164C	46	5305C	47	5402	36
505B	262	5166C	46	5306C	47	540219	387
506	262	5168C	46	5307C	47	5404	36
5060C	33	5170C	46	531	267	540419	387
5060/**	33	5172C	46	5310C	47	5405	36
5062C	34	5170/**	46	5311C	47	540619	387
5062/1C	34	5172/1C	46	5312C	47	540819	387
5063C	34	5173/1C	46	5313C	47	5409	36
5063/1C	34	5173C	46	5314C	47	5409/19	36
5064C	34	5174C	46	5316C	47	5410/**	42

Part Number Index

Part No.	Page	Part No.	Page	Part No.	Page	Part No.	Page
541001	387	5482C	53	55120/12	99	55382	98
541019	387	5483C	53	55121	103	55383	98
541201	387	5484C	53	55122	103	55384	98
541219	387	5485C	53	55123	103	55386	98
5413	36	5486C	53	55126	103	55389	98
5414	36	5489C	53	55129	103	5539	49
541401	387	5489/**	53	55129/12	103	5539/**	49
541419	387	548F	267	55131	103	5542	49
541626	387	548F	267	55132	103	5543	49
541801	387	5491C	52	55133	103	5544	49
541816	387	5492C	52	55136	103	55451	102
5419	36	5493C	52	55139	103	55452	102
5419/**	36	5494C	52	5514	48	55453	102
5420/**	42	5495C	52	55152	99	55455	102
5422	36	5496C	52	55153	99	55456	102
5423	36	5499C	52	55154	99	55459	102
5424	36	5499/**	52	55156	99	55459/12	102
5425	36	55002	95	55159	99	55462	97
5427	36	55003	95	55160/12	99	55463	97
5429	36	55004	95	55162	100	55464	97
5429/**	36	55006	95	55163	100	55466	97
543	268	55009	95	55164	100	55469	97
5430/**	42	55010/12	95	55166	100	5547	49
5434	37	55012	95	55169	100	55470/12	97
5435	37	55013	95	5517	48	55481	102
5437	37	55014	95	55170/12	100	55482	102
5439	37	55016	95	55172	100	55483	102
5439/**	37	55019	95	55173	100	55486	102
5440/**	43	55020/12	95	55174	100	55489	102
5442	37	55021	101	55176	100	55489/12	102
5443	37	55022	101	55179	100	5549	49
5444	37	55023	101	55180/12	100	5549/**	49
5445	37	55026	101	5519	48	55491	102
5447	37	55029	101	5519/12	48	55492	102
5449	37	55029/12	101	5519/19	48	55493	102
5449/**	37	5504	48	55192	97	55496	102
545	267	55052	95	55193	97	55499	102
5450/**	43	55053	95	55194	97	55499/11	102
5452C	53	55054	95	55196	97	5560/2C	41
5453C	53	55056	95	55199	97	5560C	41
5456C	53	55059	95	55199/12	97	5561C	41
5459/**	53	55060/12	95	5522	48	5562C	41
5459C	53	55062	96	5523	48	5563C	41
545B	267	55063	96	5524	48	5564C	41
546	267	55064	96	5525	48	5580/2C	41
5462C	39	55066	96	5527	48	5580C	41
5463C	39	55069	96	55271	103	5581C	41
5464C	39	5507	48	55272	103	5582C	41
5466C	39	55070/12	96	55273	103	5583C	41
5468C	39	55072	96	55276	103	5584C	41
5470C	39	55073	96	55279	103	5586C	41
5470/**	39	55074	96	55279/12	103	5599/**	41
5471C	341	55076	96	5529	48	5606B1601	208
5471L	307	55079	96	5529/**	48	5606B1801	208
5472C	341	55080/12	96	55291	103	560F	265
5472L	307	5509/12	48	55292	103	5610B1201	204
5473C	341	55092	97	55293	103	5610B2020	214
5473L	307	55093	97	55296	103	5610B2201	204
5474C	341	55094	97	55299	103	5616B1201	206
5474L	307	55096	97	55299/12	103	5616B2001	205
5475C	341	55099	97	5532	49	5620B1820	215
5475L	307	550F	268	5533	49	5620B2020	215
5476C	341	550F	268	5534	49	5640B2004	210
5476L	307	551	265	5535	49	5640B2012	210
5477C	341	55100/12	97	55362	98	5640B2201	210
5477L	307	55102	99	55363	98	5650B2004	111
5478C	341	55103	99	55364	98	5650B2008	111
5478L	307	55104	99	55366	98	5650B2012	111
5479C	341	55106	99	55369	98	5660	304
5479L	307	55109	99	5537	49	5661	304
547F	249	55110/12	99	55370/12	98	5662	304
547F	249	55112	99	55371	102	5663	304
5480C	341	55113	99	55372	102	5664	304
5480/**	341	55114	99	55373	102	5665	304
5480L	307	55116	99	55376	102	5666	32
5481C	53	55119	99	55379	102	5667	32

Part Number Index

Part No.	Page	Part No.	Page	Part No.	Page	Part No.	Page
5668	32	58136	364	5934	44	6204C	347
5669	32	58142	364	5935	44	6205C	347
5670	32	58144	364	5936	44	6206C	347
5671	32	58401	363	5937	44	6207C	347
5672	32	58411	363	5938	52	6208C	347
5673	32	58412	365	5939	52	6209C	347
5674	38	58413	365	5940	52	6210C	347
5675	38	58414	365	5941	52	6210/**	347
5676	38	58415	365	5942	52	6212C	347
5677	38	58416	365	5943	54	6213C	347
5678	38	58419	365	5944	54	6216C	347
5679	38	58420/19	365	5945	54	6217C	347
5680	38	58421	363	5946	54	6218C	347
5681	38	58431	364	5947	54	6220C	347
5682	44	5851	400	5951	404	6220/**	347
5683	44	5852	400	5952	404	6222C	355
5684	44	5853	400	5953	404	6223C	355
5685	44	5853/19	400	5954	404	6224C	355
5686	44	5854	400	6000C	354	6225C	355
5687	44	5854/7	400	6008C	354	6226C	355
5688	44	5855	400	6010C	354	6227C	355
5689	44	5855/7	400	6010L	307	6228C	355
5690	52	5856	400	6012C	354	6230C	355
5691	52	5856/7	400	6012L	307	6230/**	355
5692	52	5857	400	6014C	354	6300/**	318
5693	52	5858	400	6014L	307	6301	346
5694	52	5859	400	6016C	354	6304	346
5695	54	5859/**	400	6017C	354	6305	318
5696	54	58602	366	6017L	307	6306	318
5697	54	58603	366	6018C	354	6307	318
5698	54	58604	366	6019C	354	6308	318
5699	54	58612	367	601B	265	6309	318
57003	363	58613	367	6020C	354	6310	318
57004	363	58616	367	6022C	354	6311	318
57006	363	58632	367	6023C	354	6312	318
57008	363	58633	367	6024C	354	6314	359
57010	363	58642	367	6025C	354	631419	397
57015	363	58643	367	6032C	354	6315	359
5710	284	5874	401	6033C	354	6316	362
5711/**	289	5875	401	6036C	354	631619	397
5712/**	289	5876	401	6039C	354	6317	362
5712/**	289	5877	401	6042C	354	6318	362
5713/**	289	5878	401	6052C	357	631816	397
5714	288	5879	401	6053C	357	6319	362
5714/1601	290	5879/**	401	6054C	357	6320	362
5715	288	58802	366	6056C	357	6321	362
5716	288	58803	366	6059C	357	6322	362
5717/**	290	58804	366	6059/**	357	6323	362
5718/**	290	58806	366	6062C	357	6324	362
5721	288	58809	366	6063C	357	6325	362
5724	288	58812	366	6064C	357	6326	362
5724S	288	58902	366	6066C	357	6327	338
5740	288	58903	366	6069/15C	357	6328	338
5741H	288	58904	366	6069C	357	6329	338
57602	365	58906	366	6072C	370	633	266
57603	365	58909	366	6073C	370	6330	338
57604	365	58912	366	6076C	370	6331	338
57605	365	5902C	342	6079C	370	6332	338
57606	365	5905C	342	6079/**	370	6333	338
57628	365	5906C	342	6083C	345	6334	338
57632	365	5909C	342	6084C	345	6335	338
57634	365	5909/**	342	6087C	345	6336	338
57636	365	5920	32	6089C	345	6337	338
58110/25	363	5921	32	6089/18C	345	6338	338
58113	363	5922	32	6112	415	6339	338
58114	363	5923	32	6113	415	6340	338
58116	363	5924	32	6115	415	6341	338
58117	363	5925	32	6116	415	6342	338
58118	363	5926	38	6117	415	6343	338
58119	363	5927	38	6118	415	6344	338
58120	363	5928	38	6119	415	6345	338
58120/**	363	5929	38	6120	415	6346	338
58124	363	5930	38	615	263	6347	338
58126	363	5931	38	616	263	6348	338
58133	364	5932	44	6202C	347	6349	338
58134	364	5933	44	6203C	347	6350	338

Part Number Index

Part No.	Page	Part No.	Page	Part No.	Page	Part No.	Page
6351	339	6427	344	65405CY	109	6715S	418
6352	339	6428	344	65407	107	6716	418
6353	339	6429	344	65407CY	109	6717	418
6354	339	6430	344	65409	107	6717S	418
6355	339	6431	344	65412	107	6718	418
6356	339	6432	344	65412CY	109	6719	418
6357	339	6433	344	65418	107	674/**	279
6358	339	6434	358	65418CY	109	680/**	277
6359	339	6435	358	65425	107	681/**	277
6360	339	6436	358	65504	108	682/**	277
6361	339	6437	358	65504CY	110	683/**	277
6362	351	6438	358	65505	108	684/**	277
6363	351	6439	358	656	280	685/**	277
6364	351	6440	358	65602	106	7012	394
6365	351	6441	358	65603	106	7013	394
6366	351	6442	358	65603CY	109	7014	394
6367	351	6443	358	65604	106	702/2R	275
6368	351	6444	358	65604CY	109	7024	393
6369	351	6445	358	65605	106	7025	393
6370	351	6446	358	65605CY	109	7026	393
6371	351	6447	358	65607	106	702R	275
6372	351	6448	358	65607CY	109	703/**	275
6373	351	6450	303	65609	106	7035	393
6374	351	6451	298	65612	106	7036	393
6375	351	6452	298	65612CY	109	703R	275
6376	351	6453	302	65618	106	704/**	275
6377	351	6454	302	65618CY	109	7044	393
6378	351	6455	302	65625	106	7045	393
6379	351	6456	302	65625CY	109	7046	393
6380	351	6457	302	65641	106	7047	393
6381	351	6458	297	65650	106	7048	393
6382	351	6459	299	65704	108	704R	275
6383	351	6460	299	65704CY	110	705/**	275
6384	351	6461	296	65705	108	7053	391
6385	360	6462	301	65802	106	7054	391
6386	360	6463	301	65803	106	7054/19	391
6387	360	650	282	65803CY	109	7055	391
6388	360	65002	106	65804	106	7055/19	391
6389	360	65003	106	65804CY	109	7056	391
6390	352	65003CY	109	65805	106	7056/19	391
6391	352	65004	106	65805CY	109	7057	391
6392	352	65005	106	65807	106	7057/19	391
6393	352	65007	106	65807CY	109	7058/19	391
6394	352	65007CY	109	65809	106	705R	275
6395	352	65009	106	65812	106	706/**	275
6396	352	65012	106	65812CY	109	706R	275
6397	352	65012CY	109	65818	106	707/**	275
6398	352	65018	106	65818CY	109	707R	275
6399	352	65025	106	65825	106	708/4R	276
640	266	65025CY	109	65825CY	109	710/4R	276
6400	352	651	281	65834	106	712/4R	276
6401	353	65103	107	65841	106	7130	392
6402	353	65103CY	110	65850	106	7131	392
6403	353	65104	107	659	280	7132	392
6404	353	65104CY	110	65904	107	7133	392
6405	353	65105	107	65904CY	110	7134	392
6406	353	65105CY	110	65905	107	715/4R	276
6407	353	65107CY	110	6622	312	71602	260
6408	353	652	281	6623	312	71801	260
6409	353	65203	107	6624	312	71802	260
6410	353	65203CY	110	6632	312	72001	260
6411	353	65204	107	6633	312	722/2R	276
6412	353	65204CY	110	6634	312	72203	260
6413	353	65205	107	6642	312	723/2R	276
6414	353	65205CY	110	6643	312	72402	260
6415	353	65207	107	6644	312	725	278
6417	344	65304	108	665/4	279	727	278
6418	344	65304CY	110	6652	312	7431	283
6419	344	65305	108	6653	312	7432	283
6420	344	654	280	6654	312	7434	283
6421	344	65402	107	6710	418	7436	283
6422	344	65403	107	6711	418	7437	283
6423	344	65403CY	109	6712	418	7439	283
6424	344	65404	107	6713	418	751000	396
6425	344	65404CY	109	6714	418	751265	396
6426	344	65405	107	6715	418	751441	396

Part Number Index

Part No.	Page	Part No.	Page	Part No.	Page	Part No.	Page
751626	396	788133	383	85504CY	114	86204CY	116
751816	396	789	263	85603	111	86205	115
752010	396	801	269	85603CY	113	86205CY	116
758133	396	801530W	516	85604	111	86207	115
760/2	278	801536B	516	85604CY	113	86207CY	116
760/4	278	801536W	516	85605	111	86212	115
7614/6	198	801566B	517	85605CY	113	86212CY	116
7616/6	198	802	269	85607	111	86218	115
7622	325	802534B	516	85607CY	113	86218CY	116
7623	325	802534W	516	85612	111	86225	115
7624	325	802566B	517	85612CY	113	86225CY	116
7631	325	803215B	518	85615CY	113	86302	115
7632	325	803215W	518	85618	111	86302CY	116
7633	325	803554	518	85618CY	113	86303	115
7634	325	804812W	518	85625	111	86303CY	116
7661	325	804814B	518	85625CY	113	86304	115
7662	325	804814W	518	85634	111	86304CY	116
7663	325	805032B	516	85634CY	113	86305	115
7664	325	805032W	516	85650	111	86305CY	116
7671	325	805036B	516	85704	112	86307	115
7672	325	805036W	516	85704CY	114	86307CY	116
7673	325	805040B	516	85803	111	86312	115
7674	325	805040W	516	85803CY	113	86312CY	116
7680	283	805178B	517	85804	111	86318	115
7681	283	805178W	517	85804CY	113	86318CY	116
7682	283	805060B	517	85805	111	86325	115
7684	283	805062B	517	85805CY	113	86325CY	116
7700	283	805062W	517	85807	111	86401CY	117
7701	283	805066W	517	85807CY	113	86402CY	117
7702	283	807013B	518	85812	111	86403CY	117
775	263	807013W	518	85812CY	113	86404CY	117
776	263	807510W	517	85815	111	86405CY	117
7760	284	808036B	516	85818	111	86406CY	117
7761	284	808036W	516	85818CY	113	86408CY	117
7762	284	808058B	517	85825	111	86410CY	117
7764	284	808060W	517	85825CY	113	86414CY	117
7765	284	810010W	517	85834	111	86501CY	117
7766	284	812030W	518	85904	112	86502CY	117
777	262	815040W	518	85904CY	114	86503CY	117
777B	262	820	269	86002	115	86504CY	117
778	263	821	269	86002CY	116	86517CY	117
779	262	822	269	86003	115	86506CY	117
779B	262	830	269	86003CY	116	86508CY	117
780	262	831	269	86004	115	86510CY	117
7800	284	832	269	86004CY	116	86514CY	117
780001	383	85003	111	86005	115	86601CY	118
780002	383	85003CY	113	86005CY	116	86602CY	118
780003	383	85004	111	86007	115	86603CY	118
780004	383	85004CY	113	86007CY	116	86604CY	118
7801	284	85005	111	86012	115	86605CY	118
780B	262	85005CY	113	86012CY	116	86606CY	118
781	263	85007	111	86018	115	86608CY	118
781001	383	85007CY	113	86018CY	116	86610CY	118
781201	383	85010CY	113	86025	115	86614CY	118
781259	383	85012	111	86025CY	116	86701CY	118
781401	383	85012CY	113	86102	115	86702CY	118
781601	383	85018	111	86102CY	116	86703CY	118
781801	383	85018CY	113	86103	115	86704CY	118
781816T	383	85025	111	86103CY	116	86705CY	118
781836	383	85025CY	113	86104	115	86706CY	118
782	263	85034	111	86104CY	116	86708CY	118
782001	383	85104	112	86105	115	86710CY	118
782010T	383	85104CY	114	86105CY	116	86714CY	118
782133	383	85107	112	86107	115	87003	119
782201	383	85107CY	114	86107CY	116	87003CY	121
782207T	383	85204	112	86112	115	87004	119
782401	383	85204CY	114	86112CY	116	87004CY	121
782607	383	85207	112	86118	115	87005	119
782665	383	85207CY	114	86118CY	116	87005CY	121
783	263	85304	112	86125	115	87007	119
784	263	85304CY	114	86125CY	116	87007CY	121
784133	383	85404	111	86202	115	87103	119
786133	383	85404CY	113	86202CY	116	87103CY	121
787	262	85407	111	86203	115	87104	119
787B	262	85407CY	113	86203CY	116	87104CY	121
788	263	85504	112	86204	115	87105	119

Part Number Index

Part No.	Page	Part No.	Page	Part No.	Page	Part No.	Page
87105CY	121	882003	216	920	270	F18004*W	127
87107	119	882004	216	9213	242	F18005*W	127
87107CY	121	882005	216	9214	242	F18007*W	127
87203	119	882006	216	9217	242	F18012*W	127
87203CY	121	882007	216	9223	242	F18017*W	127
87204	119	882008	216	9316	242	F18022*W	127
87204CY	121	882010	216	932	421	F18025*W	127
87205	119	882012	216	934	421	F18034*W	127
87205CY	121	882015	216	936	421	F18042*W	127
87207	119	882020	216	938	421	F18049*W	127
87207CY	121	882025	216	95079	520	F18065*W	127
87303	119	882202	218	95106	520	FIT-105-**	450
87303CY	121	882203	218	952	270	FIT-221-**	451
87304	119	882204	218	953	270	FIT-221B-**	452
87304CY	121	882205	218	9810	250	FIT-221-MS-*	452
87305	119	882206	218	9817	246	FIT-221V-**	454
87305CY	121	882207	218	9823	246	FIT-260-**	455
87307	119	882208	218	9830	250	FIT-295-**	456
87307CY	121	882209	218	9848	238	FIT-300-**	457
87403	120	882210	218	9852C	254	FIT-321-**	458
87403CY	122	882212	218	9853C	254	FIT-321V-**	459
87404	120	882215	218	9854C	254	FIT-350-**	460
87404CY	122	882220	218	9888C	246	FIT-400-**	461
87405	120	882225	218	AF-155-**	499	FIT-421-**	462
87405CY	122	882230	218	AT103726	403	FIT-500-**	463
87407	120	882240	218	AT121925	403	FIT-600-**	464
87407CY	122	882250	218	AT141927	403	FIT-621-**	465
87503	120	882260	218	AT161929	403	FIT-650-**	466
87503CY	122	882402	218	AT181930	403	FIT-700-**	467
87504	120	882403	218	AT201932	403	FIT-750-**	468
87504CY	122	882404	218	AT221934	403	FIT-CLEAR-**	471
87517	120	882406	218	AT241936	403	FIT-CRIMP	478
87517CY	122	891000	380	AT261938	403	FIT-FAB-**	469
87507	120	891265	380	AT261938	403	FIT-FLEX-**	470
87507CY	122	891441	380	AT813329	403	FIT-GUN*	480
87603	120	891816T	380	AZ103726	403	FIT-KIT-1	476
87603CY	122	891819	380	AZ123728	403	FIT-KIT-2	476
87604	120	892007	380	AZ141927	403	FIT-KIT-7	476
87604CY	122	892010T	380	AZ161929	403	FIT-KIT-221BK	452
87605	120	892019	380	AZ181930	403	FIT-KIT-221-R	477
87605CY	122	892207T	380	AZ201932	403	FIT-KIT-221C	452
87607	120	892219	380	AZ221934	403	FIT-MG1	480
87607CY	122	892407T	380	AZ241936	403	FIT-MGKIT-1	477
87703	120	892419	380	AZ413325	403	FIT-PRINT-**	475
87703CY	122	9008	240	AZ813329	403	FIT-SLV-**	483
87704	120	9011A	252	C160	517	FNT-**	490
87704CY	122	9055B	240	C162	517	GRP-110-**	505
87705	120	9058	238	C164	517	GRP-110NF**	506
87705CY	122	9058A	238	CAP-**	472	GRP-120-**	505
87707	120	9058AC	238	CST-**	503	GRP-120NF**	506
87707CY	122	9058C	238	F08004*W	128	GRP-130-**	507
881202	217	9058X	238	F10004*W	128	GRP-130NF-**	507
881203	217	9059	250	F10005*W	128	GRP-160-**	508
881403	217	9059B	250	F10007*W	128	GRP-170-**	509
881404	217	9059C	250	F12004*W	128	GRP-180-**	510
881405	217	906	421	F12005*W	128	GRP-200-**	511
881602	217	9062A	244	F12007*W	128		
881603	217	9062AC	244	F14004*W	128		
881604	217	908	417	F14005*W	128	HU-KIT-**	422
881605	217	910 (cord)	271	F14007*W	128	LC-**	516
881606	217	910 (bus bar)	421	F14012*W	128	M08104*W	130
881607	217	9102	250	F16003*W	127	M08105*W	130
881610	217	9104	252	F16004*W	127	M10104*W	130
881802	216	9105	252	F16005*W	127	M10105*W	130
881803	216	9108	246	F16007*W	127	M10107*W	130
881804	216	9109	246	F16012*W	127	M1102	146
881805	216	911	271	F16017*W	127	M1103	146
881806	216	9158S	238	F16019*W	127	M1104	146
881807	216	9159	250	F16022*W	127	M1105	146
881808	216	9174	242	F16025*W	127	M1106	146
881809	216	9178B	242	F16033*W	127	M1112	146
881812	216	9179B	254	F16042*W	127	M1113	146
881815	216	9180B	244	F16049*W	127	M1114	146
881820	216	9187A	254	F16065*W	127	M1115	146
881825	216	9188A	242	F18003*W	127	M1116	146
882002	216	9196A	242	F18003*W	127	M1118	146

Part Number Index

Part No.	Page	Part No.	Page	Part No.	Page	Part No.	Page
M1122	146	M13082	151	M13315	143	M16117*W	129
M1123	146	M13083	151	M13320	143	M16119*W	129
M1124	146	M13084	151	M13325	143	M1612	188
M1125	146	M13085	151	M13330	143	M16122*W	129
M1126	146	M13086	151	M13340	143	M16125*W	129
M1128	146	M13088	151	M13350	143	M16133*W	129
M1130	146	M13089	151	M13402	143	M16142*W	129
M1132	146	M13092	151	M13404	143	M16149*W	129
M113226	175	M13095	151	M13405	143	M16165*W	129
M113227	175	M13099	151	M13407	143	M1644	189
M113232	175	M13103	154	M13409	143	M1645	189
M113233	175	M13106	154	M13412	143	M1646	189
M113242	175	M13109	154	M13415	143	M1648	189
M113243	175	M13111	154	M13502	144	M1650	189
M113244	175	M13112	154	M13503	144	M1704	190
M113247	175	M13115	154	M13504	144	M1705	190
M113248	175	M13117	154	M13517	144	M1706	190
M1135	164	M13119	154	M13507	144	M1708	190
M1140	146	M13127	154	M13509	144	M1710	190
M1142	147	M13130	154	M13512	144	M1712	190
M1143	147	M13142	154	M13515	144	M1714	190
M1144	147	M13143	155	M13519	144	M1716	190
M1146	147	M13146	155	M13525	144	M1764	190
M1162	147	M13149	155	M13572	144	M1765	190
M1163	147	M13151	155	M13574	144	M1766	190
M1164	147	M13152	155	M13582	144	M1768	190
M1201	258	M13155	155	M13584	144	M1772	190
M1202	258	M13173	155	M13590	144	M1776	190
M1203	258	M13176	155	M14104*W	130	M1779	190
M1204	258	M13179	155	M14105*W	130	M1787	190
M12104*W	130	M13182	155	M14107*W	130	M18103*W	129
M1211	258	M13185	155	M1411	188	M18104*W	129
M1212	258	M13190	231	M14112*W	130	M18105*W	129
M1213	258	M13191	231	M1412	188	M18107*W	129
M1214	258	M13192	231	M14125*W	130	M18112*W	129
M1221	258	M13193	231	M1421	188	M18117*W	129
M1222	258	M13194	231	M1422	188	M18122*W	129
M1223	258	M13195	231	M1423	188	M18125*W	129
M1224	258	M13196	231	M1431	188	M18134*W	129
M1231	258	M13197	231	M1432	188	M18142*W	129
M1232	258	M13198	231	M14327	170	M18149*W	129
M1233	258	M13199	231	M14328	170	M18165*W	129
M1234	258	M13200	231	M1433	188	M213102	177
M1241	259	M13201	231	M1441	189	M213103	177
M1242	259	M13202	231	M1442	189	M213104	177
M1243	259	M13203	164	M14429	169	M213106	177
M1244	259	M13209	164	M1443	189	M213142	177
M1251	259	M13210	164	M1444	189	M213143	177
M1252	259	M13222	166	M14461	158	M213144	177
M1253	259	M13226	166	M14462	158	M213146	177
M1254	259	M13227	166	M14474	171	M213172	177
M13001	150	M13229	167	M14475	172	M213173	177
M13002	150	M13232	167	M14476	171	M213174	177
M13003	150	M13233	167	M14477	172	M213176	177
M13004	150	M13242	167	M14478	172	M213182	178
M13005	150	M13243	167	M1451	189	M213183	178
M13006	150	M13244	167	M1452	189	M213184	178
M13008	150	M13247	168	M1453	189	M213191	178
M13009	150	M13248	168	M1454	189	M213192	178
M13013	150	M13249	168	M1461	189	M213193	178
M13019	150	M13250	168	M1462	189	M213202	178
M13027	150	M13272	162	M1463	189	M213203	178
M13032	150	M13282	163	M1471	189	M213204	178
M13033	150	M13283	163	M1472	189	M213206	178
M13034	150	M13287	163	M1473	189	M213222	178
M13036	150	M13291	173	M1474	189	M213223	178
M13039	150	M13302	143	M1604	188	M213224	178
M13042	150	M13303	143	M1605	188	M213302	174
M13045	150	M13304	143	M1606	188	M213303	174
M13049	150	M13305	143	M1608	188	M213304	174
M13057	150	M13306	143	M1610	188	M213305	174
M13063	151	M13307	143	M16103*W	129	M213308	174
M13066	151	M13308	143	M16104*W	129	M213402	174
M13069	151	M13309	143	M16105*W	129	M213403	174
M13072	151	M13310	143	M16107*W	129	M213404	174
M13081	151	M13312	143	M16112*W	129	M213502	174

Part Number Index

Part No.	Page	Part No.	Page	Part No.	Page	Part No.	Page
M213503	174	M2465	228	M33220	165	M33868	196
M213504	174	M2467	228	M33221	165	M33869	196
M213572	174	M2470	228	M33302	161	M33870	196
M213573	174	M2473	226	M33303	161	M33871	196
M213574	174	M2474	226	M33304	161	M33873	196
M2210	176	M2475	226	M33305	161	M33876	196
M2211	176	M2476	226	M33306	161	M33877	196
M2212	176	M2477	226	M33308	161	M33879	196
M2215	176	M2478	226	M33310	161	M33902	196
M2216	176	M2479	226	M33312	161	M33903	196
M2217	176	M2480	226	M33315	161	M33904	196
M2222	176	M2481	226	M33320	161	M33905	196
M2223	176	M2482	226	M33325	161	M33906	196
M2224	176	M2483	226	M33330	161	M33907	196
M2226	176	M2485	226	M33340	161	M33910	196
M239023	175	M2487	234	M33350	161	M33912	196
M239024	175	M2488	234	M33360	161	M3420	234
M239025	175	M2489	234	M33402	159	M3421	234
M2403	224	M2490	234	M33403	159	M3422	234
M2404	224	M2492	234	M33404	159	M3423	234
M2405	224	M2493	234	M33406	159	M3424	234
M2406	224	M2494	234	M33408	159	M3425	234
M2407	224	M2495	234	M33410	159	M3426	234
M2408	224	M2496	234	M33412	159	M3427	234
M2409	224	M2497	234	M33415	159	M3428	234
M2410	224	M2498	234	M33419	159	M3429	234
M2412	224	M3189	231	M33502	159	M3430	234
M2414	224	M3190	231	M33503	159	M3431	234
M2416	224	M3191	230	M33504	159	M3433	237
M2420	224	M3192	230	M33517	159	M3434	237
M243103	184	M3202	164	M33506	159	M3435	237
M243106	184	M3204	164	M33507	159	M3436	237
M243142	184	M3206	164	M33508	159	M3437	237
M243143	184	M3207	164	M33510	159	M3438	237
M243144	184	M3208	164	M33512	159	M3439	237
M243172	184	M3212	164	M33515	159	M3440	237
M243173	184	M3213	164	M33519	159	M3441	237
M243473	184	M3214	164	M33525	159	M3442	237
M2438	225	M3216	164	M33572	160	M3443	237
M2439	225	M3217	164	M33573	160	M3444	237
M2440	225	M3222	152	M33574	160	M3446	237
M2441	225	M3223	152	M33576	160	M3447	237
M2442	225	M3224	152	M33578	160	M3448	237
M2443	225	M3226	152	M33582	160	M3449	237
M2444	225	M3227	152	M33583	160	M3450	237
M2445	225	M3228	152	M33590	160	M3451	237
M2447	225	M3232	152	M33591	160	M3452	237
M244800	179	M3233	152	M33800	195	M3453	237
M244801	179	M3234	152	M33801	195	M3454	237
M244802	179	M3242	152	M33802	195	M3455	237
M244804	179	M3243	152	M33803	195	M3475	235
M244806	179	M3244	152	M33805	195	M3476	235
M244808	179	M3247	153	M33807	195	M3477	235
M244816	179	M3248	153	M33810	195	M3478	235
M244817	179	M3249	153	M33815	195	M3479	235
M244818	179	M3250	153	M33819	195	M3480	235
M244825	180	M3261	162	M33826	195	M3481	235
M244826	180	M3262	162	M33828	195	M3482	235
M244827	180	M3263	162	M33829	195	M3483	235
M244834	180	M3264	162	M33830	195	M3484	235
M244835	180	M3266	162	M33832	195	M3485	235
M244836	180	M3271	162	M33834	195	M3601	139
M244837	179	M3272	162	M33837	195	M3605	139
M244838	179	M3273	162	M33838	195	M3611	139
M244839	179	M3274	162	M33839	195	M3633	139
M2449	225	M3276	162	M33845	195	M3635	139
M2452	225	M3281	162	M33847	195	M3704	145
M2455	225	M3282	162	M33848	195	M3705	145
M2456	228	M3283	162	M33849	195	M3707	145
M2457	228	M3284	162	M33851	195	M3709	145
M2458	228	M3287	163	M33853	195	M3712	145
M2459	228	M3288	163	M33856	195	M3715	145
M2460	228	M3289	163	M33857	195	M3719	145
M2461	228	M3290	163	M33858	195	M3725	145
M2462	228	M33218	165	M33865	196	M3800	191
M2463	228	M33219	165	M33867	196	M3801	191

Part Number Index

Part No.	Page	Part No.	Page	Part No.	Page	Part No.	Page
M3802	191	M39024	166	M39143	201	M4101	407
M3803	191	M39025	166	M39144	201	M4102	407
M3804	191	M39026	166	M39145	201	M4103	407
M3805	191	M39027	166	M39146	201	M4104	407
M3806	191	M39028	166	M39147	200	M4105	407
M3807	191	M39029	166	M39148	200	M4110	407
M3808	191	M3903	193	M39149	200	M4111	407
M3810	191	M39030	166	M3915	193	M4112	407
M3815	191	M39031	166	M39150	200	M4113	407
M3819	191	M39032	166	M39151	200	M4114	408
M3821	191	M39033	166	M39152	200	M4115	408
M3822	191	M39034	166	M39153	200	M4116	408
M3823	191	M39035	166	M39154	200	M4117	408
M3825	191	M39036	166	M39155	200	M4118	408
M3826	191	M39037	166	M39156	200	M4120	408
M3828	191	M39039	154	M39157	200	M4121	408
M3829	191	M3904	193	M39158	200	M4122	408
M3830	191	M39040	154	M39159	200	M4123	408
M3831	191	M39041	154	M3916	193	M413226	181
M3832	191	M39042	154	M39160	200	M413242	181
M3833	191	M39047	148	M39161	200	M4154	246
M3834	191	M39048	148	M39162	200	M4158	246
M3835	191	M39049	148	M39163	200	M4182	252
M3837	191	M3905	193	M39249	233	M4201	240
M3838	191	M39050	148	M39250	233	M4203	244
M3839	191	M39051	149	M39251	233	M4204	252
M3840	191	M39052	149	M39252	233	M4206	240
M3841	191	M39056	194	M39254	233	M4207	252
M3842	191	M39057	194	M39256	233	M4208	252
M3843	191	M39058	194	M39275	233	M4210	238
M3845	192	M39059	194	M39259	233	M4212	240
M3847	192	M3906	193	M39260	233	M4213	238
M3848	192	M3907	193	M39262	233	M4219	238
M3849	192	M39071	199	M39268	233	M4220	246
M3850	192	M39072	199	M3931	236	M4223	250
M3851	192	M39073	199	M3932	236	M4237	250
M3852	192	M39074	199	M3940	236	M4242	248
M3853	192	M39075	199	M3970	236	M4243	248
M3854	192	M39076	199	M3971	236	M4244	248
M3856	192	M39077	199	M3972	236	M4251	242
M3857	192	M39078	199	M3973	236	M4271	246
M3858	192	M39079	199	M3974	236	M4276	244
M3859	192	M3908	193	M3975	236	M42891	187
M3860	192	M39080	199	M3977	236	M42892	187
M3861	192	M39081	199	M3978	236	M42893	187
M3862	192	M3910	193	M3979	236	M42894	187
M3865	192	M39109	197	M3980	236	M42895	187
M3867	192	M3911	193	M3981	236	M42896	187
M3868	192	M39110	197	M3982	236	M42897	187
M3869	192	M39111	197	M3983	236	M42898	187
M3870	192	M39112	197	M3984	236	M42899	187
M3871	192	M39113	202	M3985	236	M43103	184
M3872	192	M39114	202	M3986	236	M43106	184
M3873	192	M39115	202	M3987	236	M4325	170
M3874	192	M39116	202	M3988	236	M4326	170
M3876	192	M39117	202	M3989	236	M4406	173
M3877	192	M39118	202	M399	236	M44209	238
M3878	192	M39119	202	M3990	236	M44212F	250
M3879	192	M39120	202	M3992	236	M44276	242
M3880	192	M39121	202	M3993	236	M44276F	242
M3881	192	M39122	202	M4001	395	M44473	184
M3882	192	M39123	202	M4002	395	M4451	171
M3883	192	M3913	193	M4003	395	M4452	171
M38902	161	M39130	201	M4004	395	M4473	154
M38903	161	M39131	201	M4005	395	M4475	171
M38904	161	M39132	201	M4010	395	M4501	219
M38906	161	M39133	201	M4011	395	M4502	219
M38908	161	M39134	201	M4012	395	M4503	219
M38910	161	M39135	201	M4013	395	M4504	219
M38915	161	M39136	201	M4014	395	M4506	219
M38920	161	M39137	201	M4015	395	M4508	219
M38925	161	M39138	201	M4016	395	M4510	219
M38930	161	M39139	201	M4030	395	M4511	219
M38940	161	M39140	201	M4035	395	M4512	219
M38950	161	M39141	201	M4036	395	M4513	219
M3902	193	M39142	201	M4037	395	M4514	219

Part Number Index

Part No.	Page	Part No.	Page	Part No.	Page	Part No.	Page
M4515	219	M4776	231	M5436	229	M64836	183
M4517	219	M4777	231	M5500	227	M64837	182
M4518	219	M4778	231	M5501	227	M64838	182
M4519	219	M4779	231	M5502	227	M64839	182
M4520	219	M4785	230	M5503	227	M64840	182
M4522	219	M4786	230	M5504	227	M64841	182
M4523	219	M4789	230	M5517	227	M64842	182
M4524	219	M4791	230	M5506	227	M64843	182
M4602	223	M4793	230	M5507	227	M64844	182
M4603	223	M4794	230	M5508	227	M64845	182
M4604	223	M4799	230	M5509	227	M64846	182
M4606	223	M52893	185	M5510	227	M64847	182
M4607	223	M52894	185	M5511	227	M70562	414
M4608	223	M52895	185	M5512	227	M70563	414
M4610	223	M52896	185	M5513	227	M70564	414
M4612	223	M52897	185	M5514	227	M70565	414
M4614	223	M52898	185	M5515	227	M70566	414
M4616	223	M52900	185	M5516	227	M70567	414
M4618	223	M52902	185	M5517	227	M8524010	206
M4620	223	M5302	224	M5518	227	M8526010	205
M4633	223	M5303	224	M5519	227	M8528010	207
M4634	223	M5304	224	M5520	227	M8624010	212
M4635	223	M5306	224	M5521	227	M8626010	212
M4636	223	M5307	224	M5522	227	M8628010	212
M4638	223	M5308	224	M5523	227	M8704020	206
M4640	223	M5310	224	M5524	227	M8704040	206
M4642	223	M5312	224	M5525	227	M8704060	206
M4644	223	M5314	224	M5526	227	M8704080	206
M4646	223	M5316	224	M5650	232	M8704120	206
M4648	223	M5318	224	M5651	232	M8704160	206
M4650	223	M5320	224	M5652	232	M8704240	206
M4652	223	M5333	225	M5653	232	M8704360	206
M4660	220	M5334	225	M5654	232	M8704500	206
M4661	220	M5335	225	M5655	232	M8706020	205
M4662	220	M5336	225	M5656	232	M8706040	205
M4664	220	M5338	225	M5660	232	M8706060	205
M4665	220	M5340	225	M5661	232	M8706080	205
M4666	220	M5342	225	M5662	232	M8706120	205
M4668	220	M5344	225	M5665	232	M8706160	205
M4670	220	M5346	225	M5666	232	M8706240	205
M4672	220	M5348	225	M5670	232	M8706360	205
M4673	220	M5350	225	M5671	232	M8706500	205
M4675	220	M5352	225	M5673	232	M8708020	205
M4677	220	M5360	229	M5674	232	M8708040	205
M4690	220	M5361	229	M5675	232	M8708060	205
M4691	220	M5362	229	M613190	186	M8708080	205
M4692	220	M5364	229	M613191	186	M8708120	205
M4693	220	M5365	229	M613192	186	M8708160	205
M4694	220	M5366	229	M613193	186	M8708240	205
M4696	220	M5368	229	M613194	186	M8708360	205
M4697	220	M5370	229	M613226	183	M8708500	205
M4698	220	M5372	229	M613242	183	M8744020	207
M4700	220	M5375	229	M64800	182	M8744040	207
M4702	220	M5377	229	M64801	182	M8744060	207
M4704	220	M5390	229	M64802	182	M8744080	207
M4706	220	M5391	229	M64803	182	M8744120	207
M4708	220	M5392	229	M64804	182	M8744160	207
M4720	221	M5393	229	M64805	182	M8744200	207
M4721	221	M5394	229	M64806	182	M8744240	207
M4722	221	M5396	229	M64807	182	M8744360	207
M4723	221	M5397	229	M64808	182	M8744500	207
M4724	221	M5398	229	M64809	182	M8746020	207
M4726	221	M5400	229	M64812	182	M8746040	207
M4728	221	M5402	229	M64816	183	M8746060	207
M4730	221	M5404	229	M64817	183	M8746080	207
M4732	221	M5406	229	M64818	183	M8746120	207
M4734	221	M5420	229	M64820	183	M8746160	207
M4736	221	M5421	229	M64822	183	M8746200	207
M4758	231	M5422	229	M64824	183	M8746240	207
M4761	231	M5423	229	M64825	183	M8746360	207
M4770	231	M5424	229	M64826	183	M8746500	207
M4771	231	M5426	229	M64827	183	M8748020	207
M4772	231	M5428	229	M64829	183	M8748040	207
M4773	231	M5430	229	M64831	183	M8748060	207
M4774	231	M5432	229	M64834	183	M8748080	207
M4775	231	M5434	229	M64835	183	M8748120	207

Part Number Index

Part No.	Page	Part No.	Page	Part No.	Page	Part No.	Page
M8748160	207	M9600010	209	MP16105*W	131	PRM0604	435
M8748200	207	M9606010	209	MP16107*W	131	PRM0803	435
M8748240	207	M9608010	209	MP16112*W	131	PRM0804	435
M8748360	207	M9620010	210	MP16117*W	131	PRM1002	435
M8748500	207	M9624010	210	MP16122*W	131	PRM1003	435
M8804020	212	M9626010	210	MP16125*W	131	PRM1004	435
M8804040	212	M9628010	210	MP16133*W	131	PRM1202	435
M8804080	212	M9700020	214	MP16142*W	131	PRM1203	435
M8804120	212	M9700040	214	MP16149*W	131	PRM1204	435
M8804240	212	M9700060	214	MP16165*W	131	PRM1402	435
M8806020	212	M9700080	214	MP18103*W	131	PRM1403	435
M8806040	212	M9700120	214	MP18104*W	131	PRM1404	435
M8806080	212	M9700160	214	MP18105*W	131	PRM1602	435
M8806120	212	M9700240	214	MP18107*W	131	PRM1603	435
M8806240	212	M9700360	214	MP18112*W	131	PRM1604	435
M8808020	212	M9700500	214	MP18117*W	131	PSD1002	438
M8808040	212	M9706020	214	MP18122*W	131	PSD1602	438
M8808080	212	M9706040	214	MP18125*W	131	PTB1603	440
M8808120	212	M9706060	214	MP18134*W	131	PTB1604	440
M8808240	212	M9706080	214	MP18142*W	131	PTM1404	441
M8844020	213	M9706120	214	MP18149*W	131	PTM1604	441
M8844040	213	M9706160	214	MP18165*W	131	PV0230	416
M8844080	213	M9706240	214	PAM1402	437	PV0430	416
M8844120	213	M9706360	214	PAM1602	437	PV0630	416
M8844240	213	M9706500	214	PBM0001	429	PV0830	416
M8846020	213	M9708020	214	PBM0002	429	PV1030	416
M8846040	213	M9708040	214	PBM0003	429	PV1230	416
M8846080	213	M9708060	214	PBM0004	429	PV1430	416
M8846120	213	M9708080	214	PBM0130	429	PVC-105-**	489
M8846240	213	M9708120	214	PBM0230	429	PVT0226	417
M8848020	213	M9708160	214	PBM0430	429	PVT0426	417
M8848040	213	M9708240	214	PBM0630	429	PVT0626	417
M8848080	213	M9708360	214	PBM0830	429	PVT0826	417
M8848120	213	M9708500	214	PCM0802	436	PVT1028	417
M8848240	213	M9740020	215	PCM1002	436	PVT1228	417
M9000011	289	M9740040	215	PCM1202	436	PVT1430	417
M9000012	289	M9740060	215	PCM1203R	436	PWM0819	428
M9000013	289	M9740080	215	PCM1402	436	PWM1019	428
M9000014	289	M9740120	215	PCM1403R	436	PWM1202B	439
M9006011	289	M9740160	215	PCM1602	436	PWM1219	428
M9006012	289	M9740240	215	PCM1603R	436	PWM1402B	439
M9006013	289	M9740360	215	PCM1802	436	PWM1419	428
M9006014	289	M9740500	215	PDM0602	432	PWM1602B	439
M9020011	289	M9746020	215	PDM0802	432	PWM1619	428
M9020012	289	M9746040	215	PDM1002	432	PWM1802B	439
M9020013	289	M9746060	215	PDM1202	432	PWM1816	428
M9020014	289	M9746080	215	PDM1402	432	RLC-**	491
M9026011	289	M9746120	215	PDM1602	432	SF-200-**	501
M9026012	289	M9746160	215	PDM1802	432	SF61108CY	133
M9026013	289	M9746240	215	PDM2002	432	SF61110CY	133
M9026014	289	M9746360	215	PDS0602	433	SF61112CY	133
M9240041	289	M9746500	215	PDS0802	433	SF61114CY	133
M9240042	289	M9748020	215	PDS1002	433	SF61116CY	133
M9240043	289	M9748040	215	PDS1202	433	SF61118CY	133
M9240044	289	M9748060	215	PDS1402	433	SF61220CY	133
M9240081	289	M9748080	215	PDS1602	433	SF61221CY	133
M9240082	289	M9748120	215	PDS1802	433	SF61222CY	133
M9240083	289	M9748160	215	PDM0603	434	SF61223CY	133
M9240084	289	M9748240	215	PFM0803	434	SF61224CY	133
M9240121	289	M9748360	215	PFM1003	434	SLC-**	491
M9240122	289	M9748500	215	PFM1203	434	SPC-**	473
M9240123	289	MP08104*W	132	PFM1403	434	SPCM110	474
M9240124	289	MP08105*W	132	PFM1603	434	SPCM130	474
M9240162	289	MP10104*W	132	PGM0449	431	SPCM150	474
M9240241	289	MP10105*W	132	PGM0649	431	SPCM170	474
M9240242	289	MP10107*W	132	PGM0849	431	SPCM200	474
M9240243	289	MP12104*W	132	PIF-130-**	500	SPCM300	474
M9240244	289	MP12105*W	132	PIF-200-**	501	SPCM400	474
M9240362	289	MP12107*W	132	PIF-240-**	502	SPCM800	474
M9500010	203	MP14104*W	132	PPM0830	430	SPM1203	295
M9506010	203	MP14105*W	132	PPM1030	430	SPM1203CY	294
M9508010	203	MP14107*W	132	PPM1230	430	SPM1204	295
M9520010	204	MP14112*W	132	PPM1430	430	SPM1204CY	294
M9524010	204	MP14125*W	132	PPM1630	430	SPM1205	295
M9526010	204	MP16103*W	131	PPM1830	430	SPM1205CY	294
M9528010	204	MP16104*W	131	PRM0603	435	SPM1207	295

Part Number Index

Part No.	Page	Part No.	Page	Part No.	Page
SPM1207CY	294	XM1005*CY	139	XS300100	514
SPM1209	295	XM1007*	137	XS300113	514
SPM1209CY	294	XM1007*CY	139	XS300125	514
SPM1403	295	XM1203*	137	XS300134	514
SPM1403CY	294	XM1203*CY	139	XS300159	514
SPM1404	295	XM1204*	137	XS300175	514
SPM1404CY	294	XM1204*CY	139	XS300207	514
SPM1405	295	XM1205*	137	XS300238	514
SPM1405CY	294	XM1205*CY	139	XS300254	514
SPM1407	295	XM1207*	137	XS300286	514
SPM1407CY	294	XM1207*CY	139	XS300334	514
SPM1409	295	XM1403*	136	XS300366	514
SPM1409CY	294	XM1403*CY	138	ZIP-41-**	494
SPM1603	295	XM1404*	136	ZIP-GRP-**	515
SPM1603CY	294	XM1404*CY	138		
SPM1604	295	XM1405*	136		
SPM1604CY	294	XM1405*CY	138		
SPM1605	295	XM1407*	136		
SPM1605CY	294	XM1407*CY	138		
SPM1607	295	XM1412*	136		
SPM1607CY	294	XM1412*CY	138		
SPM1609	295	XM1603*	136		
SPM1609CY	294	XM1603*CY	138		
SPM1803	295	XM1604*	136		
SPM1803CY	294	XM1604*CY	138		
SPM1804	295	XM1605*	136		
SPM1804CY	294	XM1605*CY	138		
SPM1805	295	XM1607*	136		
SPM1805CY	294	XM1607*CY	138		
SPM1807	295	XM1612*	136		
SPM1807CY	294	XM1612*CY	138		
SPM1809	295	XM1617*	136		
SPM1809CY	294	XM1617*CY	138		
ST-3001-IN	457	XM1619*	136		
ST-302-**	468	XM1619*CY	138		
ST-303-**	458	XM1622*	136		
ST-650-1-1/2	466	XM1622*CY	138		
SW-**	495	XM1625*	136		
TFT-200-**	497	XM1625*CY	138		
TFT-250-**	498	XM1633*	136		
TY2001	504	XM1633*CY	138		
V16000	134	XM1642*	136		
V16001	134	XM1642*CY	138		
V16002	135	XM1649*	136		
V16004	135	XM1649*CY	138		
V16006	135	XM1665*	136		
V16008	135	XM1803*	136		
V16010	135	XM1803*CY	138		
V16012	135	XM1804*	136		
V16014	135	XM1804*CY	138		
V16016	135	XM1805*	136		
V16020	134	XM1805*CY	138		
V16030	134	XM1807*	136		
V16040	134	XM1807*CY	138		
V16108	135	XM1812*	136		
V16110	135	XM1812*CY	138		
V16112	135	XM1817*	136		
V16114	135	XM1817*CY	138		
V16116	135	XM1822*	136		
V16302	134	XM1822*CY	138		
V16304	134	XM1825*	136		
V16306	134	XM1825*CY	138		
V16308	134	XM1834*	136		
V16310	134	XM1834*CY	138		
V16312	134	XM1842*	136		
V16314	134	XM1842*CY	138		
V16316	134	XM1849*	136		
XM0803*	137	XM1849*CY	138		
XM0803*CY	139	XM1865*	136		
XM0804*	137	XS-100-2-1/2	506		
XM0804*CY	139	XS-100F*-2-1/2	506		
XM1003*	137	XS-100HD-**	512		
XM1003*CY	139	XS-200N-**	513		
XM1004*	137	XS300071	514		
XM1004*CY	139	XS300083	514		
XM1005*	137	XS300092	514		

General Index

Subject	Page	Subject	Page	Subject	Page
Audio/video cable	143 - 173	Low-smoke, zero-halogen (LSZH)	306 - 307, 417	SRML motor leads	409
Braid sleeving	505 - 515	M.A.P. power cords	261	Stationary control cable	129 - 132
Bus bar wire	422	Marine cable	528 - 441	Stereo cable	368
Coaxial cable	238 - 255	Microphone cable	157 - 258, 327 - 328	Tape	503 - 504
Communication and control cable	306 - 375	Miniature audio cable	170	Telephone cable	369
Computer cable	216 - 237	Miniature coax	248 - 249	Test lead wire	271, 405
Control cable	188 - 202	Photovoltaic wire	416 - 417	Thermocouple cable	285 - 290
ControlNet cable	297	Plenum cable	179 - 187, 363 - 365	Thermocouple extension wire	288 - 290
Copper braid	519 - 522	Portable power cable, 2000 V	282 - 2283	Thermocouple grade wire	287
Cordage, 3-conductor	272 - 2274	Power cords, 125 V	262 - 263	Tubing and fittings	489 - 498
Cordsets	261 - 284	Power supply cords	267 - 268	Tubing fittings	491, 493
Crimp splices	478	Power supply cords, international	270 - 271	Twinax cable	244 - 247
Dearborn marine cable	528 - 441	Power supply cords, medical grade	269	Variable-frequency drive (VFD) cable	134 - 136
DeviceNet cable	298	PROFIBUS-DP cable	301	Video coax	250 - 255
EcoWire	419	Resistance wire	445	Welding wire	416
EMI shielding tape	503	Retractable communication cords	275 - 281	Wire management	489 - 522
End caps	472	Retractable power cords	280	Wire wrap	405
Ethernet transceiver cable	254 - 255	Retractable test leads	282	Xtra-Guard 1 cable	31 - 56
Fieldbus cable	299	RG-6 cable	252 - 253	Xtra-Guard 2 cable	57 - 70
Fieldbus cable, high speed	300	RG-8 cable	240 - 241	Xtra-Guard 3 cable	71 - 78
FIT heat-shrink tubing	449 - 474	RG-11 cable	252 - 253	Xtra-Guard 4 cable	79 - 93
FIT-CRIMP splices	478	RG-22 cable	244 - 245	Xtra-Guard 5 cable	94 - 103
FIT-Fabric	469	RG-55 coax	238 - 239	Xtra-Guard continuous flex cable	111 - 118
FIT-PRINT	475	RG-55B	240 - 241	Xtra-Guard Flex cable	105 - 122
FIT-SLV	479	RG-58 coax	238 - 239	Xtra-Guard standard flex cable	106 - 110
Flat cable	371 - 374	RG-59 cable	250 - 251	Xtra-Guard torsional flex cable	119 - 122
Flex cable, continuous	111 - 118, 125 - 126	RG-62 cable	244 - 245	Zipper Tubing	494
	136 - 139	RG-142 cable	242 - 243		
Flex cable, light to medium duty	106 - 110	RG-174	242 - 243		
Flex cable, torsional	119 - 122	RG-179 cable	254 - 255		
Flexible motor supply cable	304	RG-180 cable	244 - 245		
Heat guns	480	RG-187 cable	254 - 255		
Heat-shrink tubing, adhesive lined	458, 465, 467 - 468, 473 - 474	RG-188 cable	242 - 243		
Heat-shrink ID	475	RG-196 cable	242 - 245		
Heat-shrink tubing kits	452, 459, 476 - 477	RG-213 cable	242 - 243		
Heat-shrink tubing	449 - 474	RG-214 cable	242 - 243		
Heat-shrink woven fabric	469	RG-217 cable	242 - 243		
Heat-shrinkable crimp splices	478	RG-223 cable	242 - 243		
Hi-Fi cable	368	RG-316 cable	242 - 243		
High-speed field bus cable	300	Ribbon cable	420 - 421		
High-temp. appliance wire	407	RS-485 cable	302		
High-temp. wire	412 - 413	Security and data cable	174 - 178		
High-temp. cable	256 - 260	Self-fusing silicone tape	504		
High-temp. motor lead wire	408	Series F cable	127 - 128		
High-voltage wire	409 - 411	Series M cable	129 - 130		
Hook-up wire kits	422	Series P control cable	131 - 132		
Hook-up wire	380 - 423	Series SF flexible servo cable	133		
Industrial automation cable	297 - 303	Series V cable	134 - 136		
Industrial twinax	303	Series XM control cable	137 - 140		
Instrumentation cable	185 - 197	Servo cable	133		
Jumper cords	265 - 266	Silver satin cable	369		
Lacing tape	516 - 518	Sleeving	499 - 502, 503 - 515		
Lamp cord	266	Slit loom tubing	492		
Line cords, electronic	264	Solar cable	293 - 295		
Litz wire	444 - 445	Soldering-iron resistant wire	391 - 392		
Low-capacitance cable	228, 233, 235 - 236, 337, 339, 345 - 347, 352 - 355, 362	Soldering sleeves	479		
		Spiral wrap tubing	496 - 497		

The Right Cable . . . Just the Way You Want It



Custom Cable as Custom as Your Application!

Alpha Wire has a long heritage of supplying a wide range of wire, cable, tubing, and accessories for varying applications. We understand that despite the breadth and depth of our product portfolio, sometimes you require a cable as unique as the application. We make it easy to configure a custom cable.

We can also help you fashion the perfect cable to meet application parameters. The Alpha Wire Cable Design Center™ allows you to quickly and easily modify any standard Alpha cable specification to your own application requirements. Count on the cable and application experts at Alpha Wire for guidance.

With our quick quotes and fast production turnaround, we will have your custom cable to you in no time.

- Meet special application requirements
- Increase system reliability with application-specific configurations
- Speed installation by reducing the number of different cables needed
- Get the best match of electrical, mechanical, and environmental properties
- Build composite cables with a mixture of conductor sizes, insulations, and shielding
- Spec your design fast with the on-line Cable Design Center
- Receive quotes quickly
- Experience industry-leading turnarounds on custom cables

GLOBAL HEADQUARTERS
711 Lidgerwood Avenue
Elizabeth, NJ 07207-0711 USA
Toll Free: 1-800-52 ALPHA
Tel: 1-908-925-8000
Fax: 1-908-925-5411
E-mail: info@alphawire.com

EUROPE
Alpha Wire International
Saxon House
1 Downside | Sunbury-on-Thames
Middlesex | United Kingdom | TW16 6RT
Tel: +44-(0)-800-288-8809
Fax: +44-(0)-800-288-8810
E-mail: europe@alphawire.com

ASIA PACIFIC
Alpha Wire
Silver Center | Room 1708
North Shanxi Road 1388
Shanghai | China | 200060
Tel: +86-21-61498201/61498205
Fax: +86-21-61498001
E-mail: apac@alphawire.com



AlphaWire

Cables you trust. Service you deserve.

For more information, the latest specifications, and tools to make cable selection easier, visit www.alphawire.com.

FIT, Cable Design Center, Dearborn, EcoWire, Loc-Trac, Kerrigan-Lewis, Manhattan, Xtra-Guard, and Zipper Tubing are trademarks of Alpha Wire. Blue Hose is a trademark of Belden Inc. ControlNet is a trademark of ControlNet International, Ltd. Copperweld is a trademark of Copperweld Steel. Chromel and Alumel are trademarks of Hoskins Manufacturing Company. DERAY is a trademark of DSG-Canusa GmbH. DeviceNet is trademark of Open DeviceNet Vendor Association, Inc. Kynar is a registered trademark of Arkema Inc. PROFIBUS is a trademark of Profibus International. Raychem and VERSAFIT are trademarks of Tyco Electronics Corporation. Teflon is a trademarks of E. I. du Pont de Nemours and Company. Viton is a trademark of Dupont Performance Elastomers LLC.

©2011 Alpha Wire. All rights reserved.
Specifications subject to change. Consult Alpha Wire for latest specifications.

Lit. No. MasterCat1107
Supersedes: MasterCat1004