

THIS DRAWING IS UNPUBLISHED. RELEASED FOR PUBLICATION AUG 2006.
 © COPYRIGHT 2009 BY TYCO ELECTRONICS CORPORATION. ALL RIGHTS RESERVED.

LOC	DIST	REVISIONS			
P	LTR	DESCRIPTION	DATE	DWN	APVD
DW	-	A1	REVISED (ECO-16-002887)	03APR2016	J.J W.H

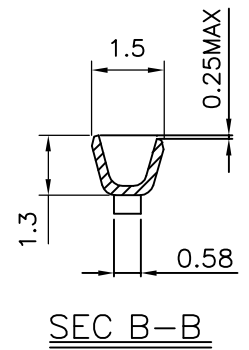
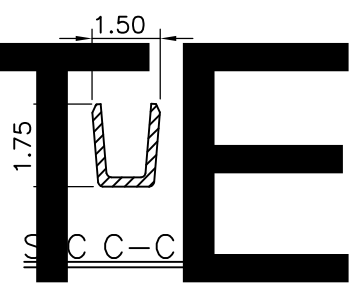
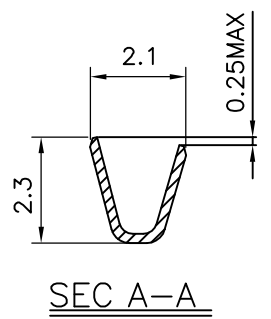
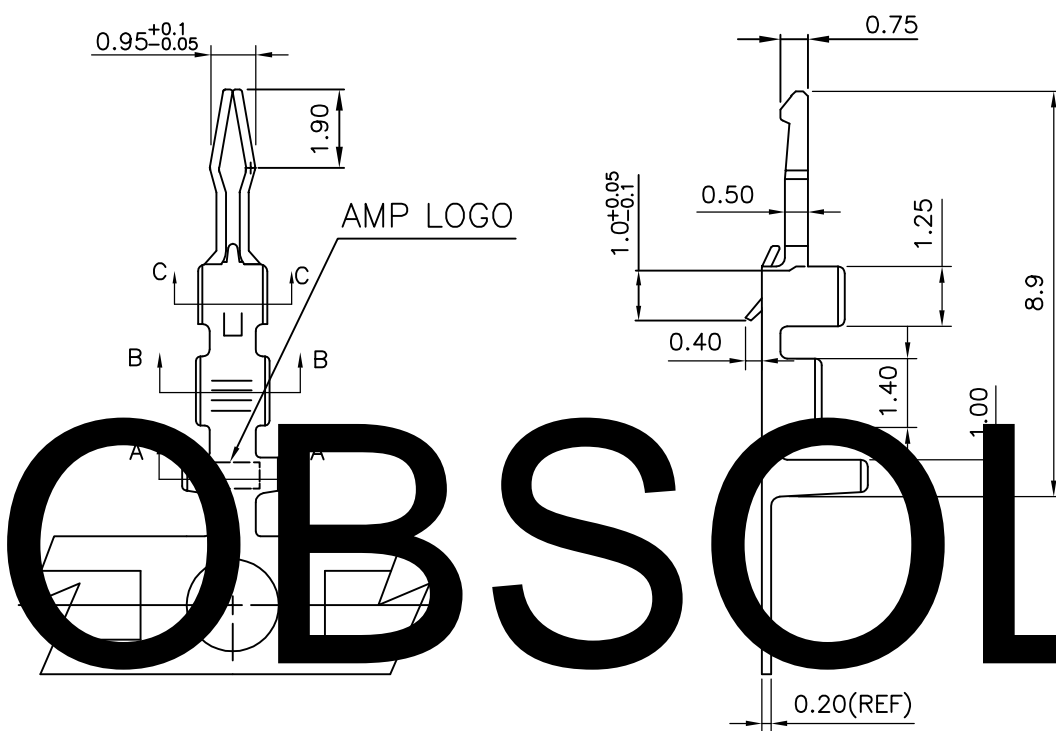

OBSOLETE

- NOTE:
- MATERIAL :
TERMINAL: BRASS.
 - FINISHED :
TERMINAL: 1.27um [50u"] MIN. TIN ON SOLDER TAILS,
0.381um [15u"] MIN. NICKEL UNDERPLATED
ALL OVER.
 - ACCEPTS HOUSING: X-1470201-X.

1470202-1
PART NUMBER

THIS DRAWING IS A CONTROLLED DOCUMENT.		DWN J. LAI 27MAY2009	Tyco Electronics Corporation Taipei, Taiwan	
DIMENSIONS: MM		CHK S. CHIEN 27MAY2009	NAME	
TOLERANCES UNLESS OTHERWISE SPECIFIED:		APVD W. KODAMA 27MAY2009	2.0 MM PITCH, CRIMP, VERTICAL, CONTACT.	
0 PLC ± -		PRODUCT SPEC	SIZE	
1 PLC ± 0.20		108-57158	CAGE CODE	
2 PLC ± 0.10		APPLICATION SPEC	DRAWING NO	
3 PLC ± 0.05		501-57248	RESTRICTED TO	
4 PLC ± -		WEIGHT	-	
ANGLES ± -		MATERIAL	A3 00779 C=1470202	
SEE NOTE		FINISH	SCALE	
SEE NOTE		CUSTOMER DRAWING	SHEET	
			1 OF 2	
			REV A1	

4

3

2

1

THIS DRAWING IS UNPUBLISHED.

RELEASED FOR PUBLICATION AUG 2006.

© COPYRIGHT 2009

BY TYCO ELECTRONICS CORPORATION.

ALL RIGHTS RESERVED.

LOC
DW

DIST

REVISIONS

P	LTR	DESCRIPTION	DATE	DWN	APVD
		SEE SHEET 1.			

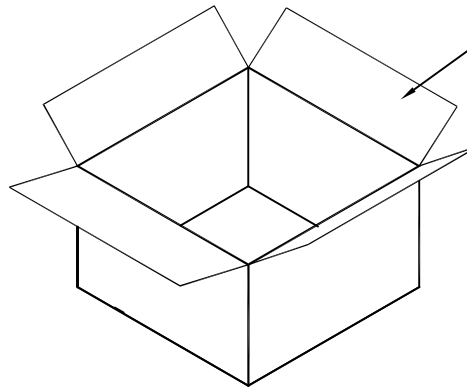

CARTON
590mm(L)X590mm(W)X115mm(H)
40,000 TERMINALS / CARTON

OBSOLETE

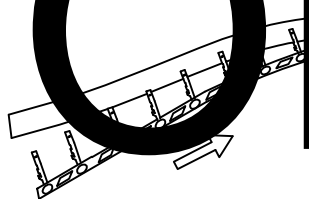

REEL
DIAMETER: ϕ 580mm.
10,000 TERMINALS / REEL

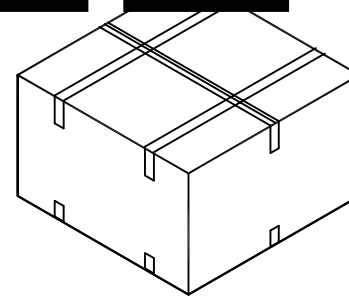

THIS DRAWING IS A CONTROLLED DOCUMENT.

DIMENSIONS: MM		TOLERANCES UNLESS OTHERWISE SPECIFIED:	
	0 PLC	±	-
	1 PLC	±	-
	2 PLC	±	-
	3 PLC	±	-
	4 PLC	±	-
	ANGLES	±	-
MATERIAL	FINISH		

DWN	
CHK	
APVD	
PRODUCT SPEC	
APPLICATION SPEC	
WEIGHT	
CUSTOMER DRAWING	

		Tyco Electronics Corporation Taipei, Taiwan	
NAME		2.0 MM PITCH, CRIMP, VERTICAL, CONTACT.	
SIZE	CAGE CODE	DRAWING NO	RESTRICTED TO
A3	00779	G=1470202	
SCALE		SHEET	REV
-		2 of 2	A1