

Ratings
 Voltage: 150 V
 Temperature: -40~70 °C

Conductor
 Conductor count: 7
 Gauge: 22 AWG 0.33 mm²
 Material: Tinned copper strands
 Strand size: \varnothing 0.08x65
 Resistance at 20 °C: 59.4 Ω /km max

Insulator
 Material: HDPE
 Color: white, black, red, yellow, white
 Diameter: \varnothing 1.25 \pm 0.10 mm
 Nominal thickness: 0.24 mm
 Resistance at 20 °C: 100 M Ω /km min

Wrap
 Material: cotton paper

Filler
 Material: aramid fiber

Outer jacket
 Material: TPU
 Color: gray
 Diameter: \varnothing 5.1 \pm 0.25 mm
 Nominal thickness: 0.60 mm

Tests
 Tensile strength: 26 kgf min
 Dielectric test: 1500 V dc for 1 minute without breakdown
 Bend test at 200 g, \pm 60 °, 30 cycles /min: 15,000 cycle minimum

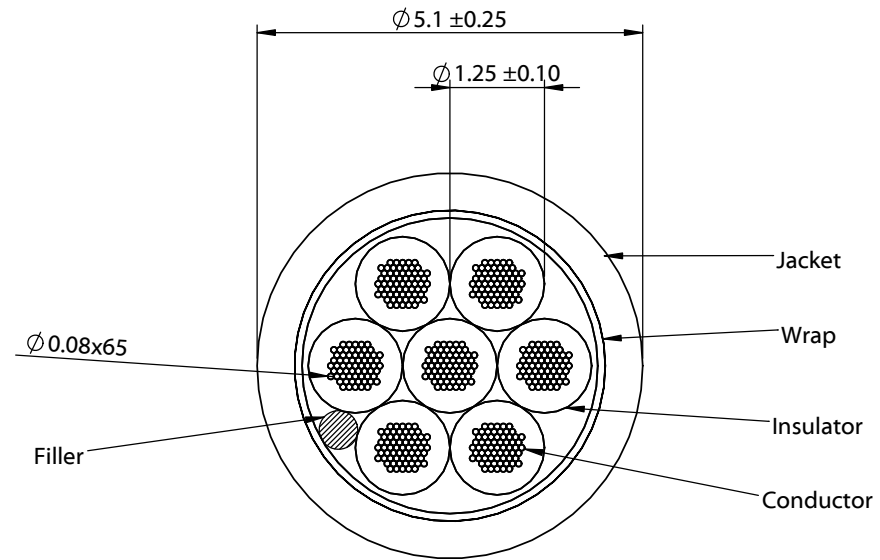
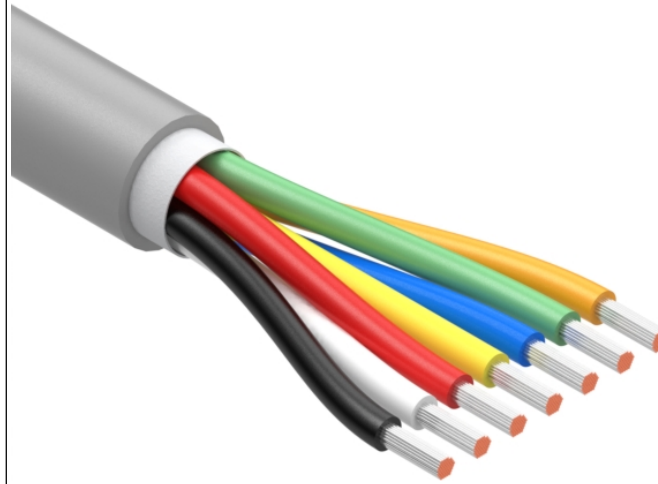

Revision:	Date:	Description:
A	9/15/2022	Initial release

Prepared: **MP**
Digitally signed by MP
 Date: 2022.09.23 14:23:17 -07'00'

Verified: **PB**
Digitally signed by PB
 Date: 2022.09.26 07:56:07 -07'00'

Dimensions are in millimeters.
 Tolerances:
 X: \pm 0.5 mm
 X.X: \pm 0.3 mm
 X.XX: \pm 0.05 mm

Notes:
 RoHS compliant
 Jacket meets ISO 10993 Biological Compatibility
 Phthalate and halogen free
 Function test: no open, no short, no intermittent

Description:
 Wire, 7C TS, 22 AWG, 150V, 70C, 5.1 mm, TPU, 75A, gray, WBL

TENSILITY
 tel 1.541.323.3228 800 877.670.7118
 fax 1.541.323.4202 web tensility.com

Size: A	Part number: 30-02744
Scale: 10:1	Sheet 1 of 1