

500mA Low-Dropout Linear Regulator in UCSP

General Description

The MAX1819 low-dropout linear regulator operates from a 2.5V to 5.5V supply and delivers a guaranteed 500mA load current with low 120mV dropout. The high-accuracy ($\pm 1\%$) output voltage is preset at an internally trimmed voltage (see the *Selector Guide*) or can be adjusted from 1.25V to 5V with an external resistive-divider.

An internal PMOS pass transistor allows the low 125 μ A supply current to remain independent of load, making this device ideal for portable battery-operated equipment such as personal digital assistants (PDAs), cellular phones, cordless phones, base stations, and notebook computers.

Other features include an active-low, open-drain reset output that indicates when the output is out of regulation, a 0.1 μ A shutdown, short-circuit protection, and thermal shutdown protection. The device is available in a miniature 6-pin UCSP™ package.

Applications

- Notebook Computers
- Cellular and Cordless Telephones
- Personal Digital Assistants (PDAs)
- Palmtop Computers
- Base Stations
- USB Hubs
- Docking Stations

UCSP is a trademark of Maxim Integrated Products, Inc.

Pin Configuration

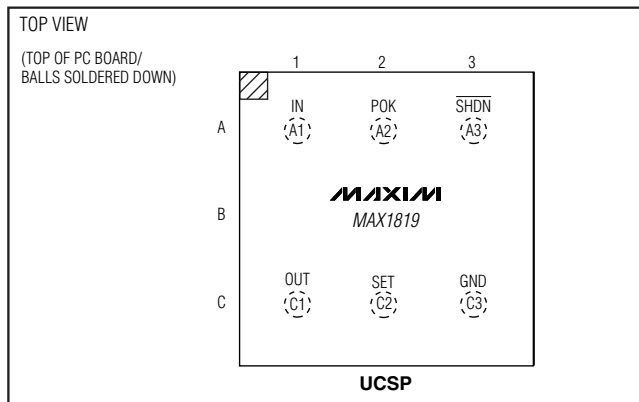

Features

- ◆ Guaranteed 500mA Output Current
- ◆ Low 90mV Dropout at 500mA
- ◆ $\pm 1\%$ Initial Output Accuracy
- ◆ Preset Output at 1.5V, 1.8V, 2V, 2.5V, 3.3V, 5V
- ◆ Adjustable Output from 1.25V to 5V
- ◆ Power-OK Output
- ◆ Low 125 μ A Ground Current
- ◆ 0.1 μ A Shutdown Current
- ◆ Thermal Overload Protection
- ◆ Output Current Limit
- ◆ Tiny 840mW 6-Pin UCSP Package

Ordering Information

PART	TEMP RANGE	PIN-PACKAGE
MAX1819EBL__-T*	-40°C to +85°C	6 UCSP

*Insert the desired two-digit suffix (see *Selector Guide*) into the blanks to complete the part number.

Selector Guide

PART AND SUFFIX	V _{OUT}	UCSP MARK
MAX1819EBL 15	1.5V or Adj	AAH
MAX1819EBL 18	1.8V or Adj	AAG
MAX1819EBL 20	2V or Adj	AAC
MAX1819EBL 25	2.5V or Adj	AAD
MAX1819EBL 33	3.3V or Adj	AAE
MAX1819EBL 50	5V or Adj	AAF

Typical Operating Circuit

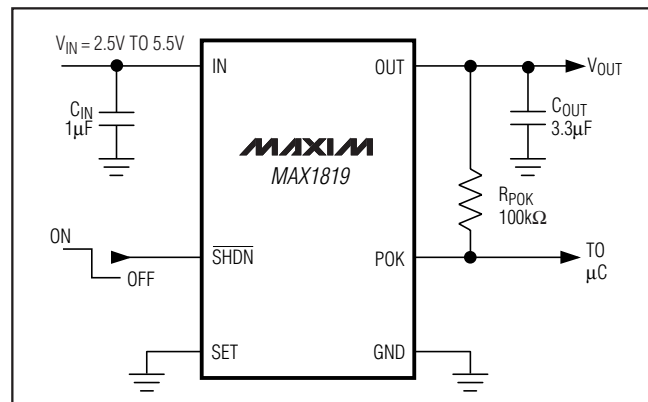

500mA Low-Dropout Linear Regulator in UCSP

Linear Regulator in

ABSOLUTE MAXIMUM RATINGS

IN, $\overline{\text{SHDN}}$, POK, SET to GND-0.3V to +6V
 OUT to GND-0.3V to ($V_{\text{IN}} + 0.3\text{V}$)
 Output Short-Circuit Duration1min
 Continuous Power Dissipation ($T_{\text{A}} = +70^{\circ}\text{C}$) (Note 1)
 6-Pin UCSP (derate 10.5mW/ $^{\circ}\text{C}$ above $+70^{\circ}\text{C}$)840mW

Operating Temperature Range-40 $^{\circ}\text{C}$ to +85 $^{\circ}\text{C}$
 Junction Temperature+150 $^{\circ}\text{C}$
 Storage Temperature Range-65 $^{\circ}\text{C}$ to +150 $^{\circ}\text{C}$
 Soldering Temperature (10s)+300 $^{\circ}\text{C}$

Note 1: Thermal properties are specified with product mounted on PC board with one square-inch of copper area and still air.

Stresses beyond those listed under "Absolute Maximum Ratings" may cause permanent damage to the device. These are stress ratings only, and functional operation of the device at these or any other conditions beyond those indicated in the operational sections of the specifications is not implied. Exposure to absolute maximum rating conditions for extended periods may affect device reliability.

ELECTRICAL CHARACTERISTICS

($V_{\text{IN}} = (V_{\text{OUT}} + 500\text{mV})$ or $V_{\text{IN}} = 2.5\text{V}$, whichever is greater; $\overline{\text{SHDN}} = \text{IN}$, $T_{\text{A}} = -40^{\circ}\text{C}$ to +85 $^{\circ}\text{C}$, unless otherwise noted. Typical values are at $T_{\text{A}} = +25^{\circ}\text{C}$.) (Note 2)

PARAMETER	SYMBOL	CONDITIONS		MIN	TYP	MAX	UNITS
Input Voltage	V_{IN}			2.5		5.5	V
Input Undervoltage Lockout	V_{UVLO}	Rising, 75mV hysteresis		2.0	2.15	2.3	V
Output Voltage Accuracy (Preset Mode)	V_{OUT}	$I_{\text{OUT}} = 100\text{mA}$, $T_{\text{A}} = +25^{\circ}\text{C}$, $V_{\text{OUT}} \geq 2\text{V}$		-1		+1	%
		$I_{\text{OUT}} = 100\text{mA}$, $T_{\text{A}} = +25^{\circ}\text{C}$, $V_{\text{OUT}} < 2\text{V}$		-1.5		+1.5	
		$I_{\text{OUT}} = 100\text{mA}$, $T_{\text{A}} = -40^{\circ}\text{C}$ to +85 $^{\circ}\text{C}$		-2.5		+2.5	
		$I_{\text{OUT}} = 1\text{mA}$ to 500mA, $V_{\text{IN}} > V_{\text{OUT}} + 0.5\text{V}$, $T_{\text{A}} = -40^{\circ}\text{C}$ to +85 $^{\circ}\text{C}$		-3		+3	
Adjustable Output Voltage Range				1.25		5.00	V
SET Voltage Threshold (Adjustable Mode)	V_{SET}	$V_{\text{IN}} = 2.7\text{V}$, $I_{\text{OUT}} = 100\text{mA}$, V_{OUT} set to 2V	$T_{\text{A}} = 0^{\circ}\text{C}$ to +85 $^{\circ}\text{C}$	1.225	1.250	1.275	V
			$T_{\text{A}} = -40^{\circ}\text{C}$ to +85 $^{\circ}\text{C}$	1.213		1.288	
Guaranteed Output Current (RMS)	I_{OUT}	$V_{\text{IN}} \geq 2.7\text{V}$		500			mA
Short-Circuit Current Limit	I_{LIM}	$V_{\text{OUT}} = 0$, $V_{\text{IN}} \geq 2.7\text{V}$		0.55	1.39	2.50	A
In-Regulation Current Limit		$V_{\text{OUT}} > 96\%$ of nominal value, $V_{\text{IN}} \geq 2.7\text{V}$			2		A
SET Dual Mode™ Threshold				50	100	150	mV
SET Input Bias Current	I_{SET}	$V_{\text{SET}} = 1.25\text{V}$		-100		+100	nA
Ground-Pin Current	I_{Q}	$I_{\text{OUT}} = 100\mu\text{A}$			125	250	μA
		$I_{\text{OUT}} = 500\text{mA}$			150		
Dropout Voltage (Note 3)	$V_{\text{IN}} - V_{\text{OUT}}$	$I_{\text{OUT}} = 500\text{mA}$	$V_{\text{OUT}} = 5\text{V}$		125	220	mV
			$V_{\text{OUT}} = 3.3\text{V}$		133	232	
			$V_{\text{OUT}} = 2.5\text{V}$		165	280	
Line Regulation	ΔV_{LNR}	V_{IN} from ($V_{\text{OUT}} + 100\text{mV}$) to 5.5V, $I_{\text{LOAD}} = 5\text{mA}$		-0.15	0	+0.15	%/V

Dual Mode is a trademark of Maxim Integrated Products, Inc.

500mA Low-Dropout Linear Regulator in UCSP

ELECTRICAL CHARACTERISTICS (continued)

($V_{IN} = (V_{OUT} + 500mV)$ or $V_{IN} = 2.5V$, whichever is greater; $\overline{SHDN} = IN$, $T_A = -40^{\circ}C$ to $+85^{\circ}C$, unless otherwise noted. Typical values are at $T_A = +25^{\circ}C$.) (Note 2)

PARAMETER	SYMBOL	CONDITIONS	MIN	TYP	MAX	UNITS
Load Regulation	ΔV_{LDR}	$I_{OUT} = 1mA$ to $500mA$		0.4	1.0	%
Output Voltage Noise		10Hz to 1MHz, $C_{OUT} = 3.3\mu F$ (ESR < 0.1 Ω)		115		μV_{RMS}
SHUTDOWN						
Shutdown Supply Current	I_{OFF}	$\overline{SHDN} = GND$, $V_{IN} = 5.5V$		0.1	15	μA
\overline{SHDN} Input Threshold	V_{IH}	$2.5V < V_{IN} < 5.5V$	1.6			V
	V_{IL}	$2.5V < V_{IN} < 5.5V$			0.6	
\overline{SHDN} Input Bias Current	I_{SHDN}	$\overline{SHDN} = IN$ or GND , $T_A = +25^{\circ}C$		1	70	nA
		$T_A = +85^{\circ}C$		5		
POK OUTPUT						
POK Output Low Voltage	V_{OL}	POK sinking 1mA		0.01	0.1	V
Operating Voltage Range for Valid POK		POK sinking 100 μA	1.0		5.5	V
POK Output High Leakage Current		POK = 5.5V, $T_A = +25^{\circ}C$		1	30	nA
		$T_A = +85^{\circ}C$		5		
POK Threshold		Rising edge, referred to $V_{OUT(NOMINAL)}$	90	93	96	%
THERMAL PROTECTION						
Thermal Shutdown Temperature	T_{SHDN}			170		$^{\circ}C$
Thermal Shutdown Hysteresis	ΔT_{SHDN}			20		$^{\circ}C$

Note 2: All devices are 100% production tested at $T_A = +25^{\circ}C$ and up to 100mA. Limits over the operating temperature range and above 100mA are guaranteed by design.

Note 3: The dropout voltage is defined as $V_{IN} - V_{OUT}$, when V_{OUT} is 100mV below the value of V_{OUT} measured for $V_{IN} = V_{OUT(NOM)} + 500mV$. Since the minimum input voltage is 2.5V, this specification is only meaningful when $V_{OUT(NOM)} > 2.5V$. For $V_{OUT(NOM)}$ between 2.5V and 3.5V, use the following equations: Typical Dropout = $-40mV/V \times V_{OUT(NOM)} + 265mV$; Guaranteed Maximum Dropout = $-60mV/V \times V_{OUT(NOM)} + 430mV$. For $V_{OUT(NOM)} > 3.5V$, Typical Dropout = 125mV; Maximum Dropout = 220mV.

Typical Operating Characteristics

($V_{IN} = (V_{OUT} + 500mV)$ or 2.5V, whichever is greater; $\overline{SHDN} = IN$, $C_{IN} = 3.3\mu F$, $C_{OUT} = 3.3\mu F$, $T_A = +25^{\circ}C$, unless otherwise noted.)

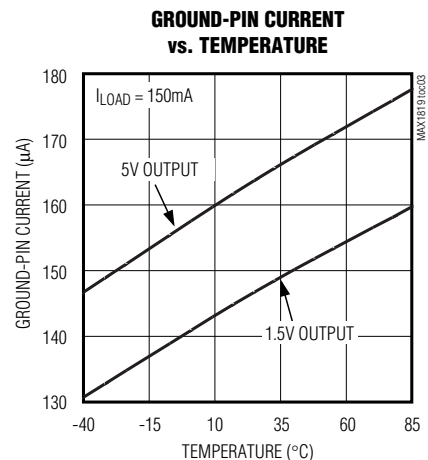
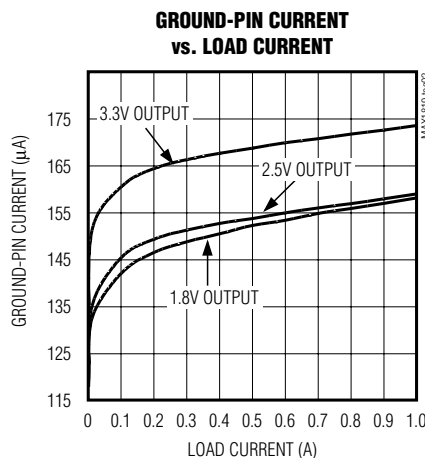
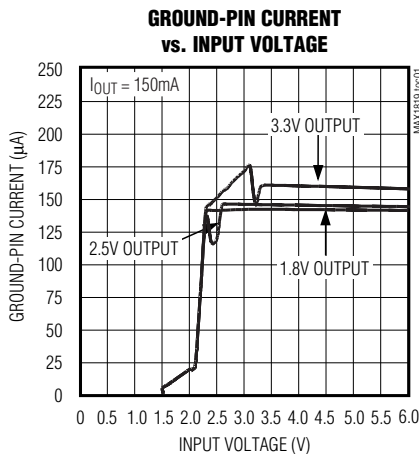

500mA Low-Dropout Linear Regulator in UCSP

Typical Operating Characteristics (continued)

($V_{IN} = (V_{OUT} + 500\text{mV})$ or 2.5V, whichever is greater; $\overline{\text{SHDN}} = \text{IN}$, $C_{IN} = 3.3\mu\text{F}$, $C_{OUT} = 3.3\mu\text{F}$, $T_A = +25^\circ\text{C}$, unless otherwise noted)

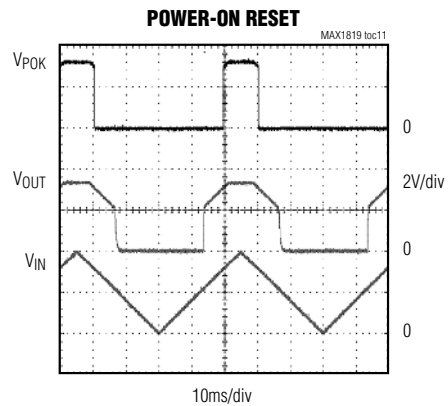
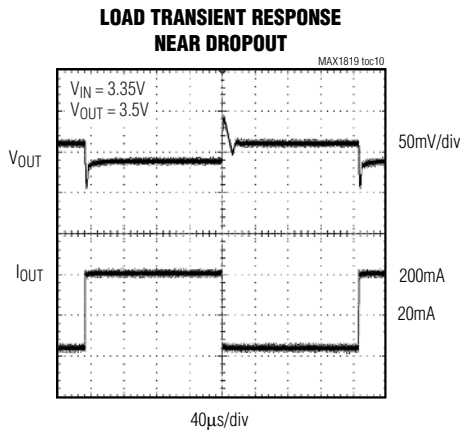
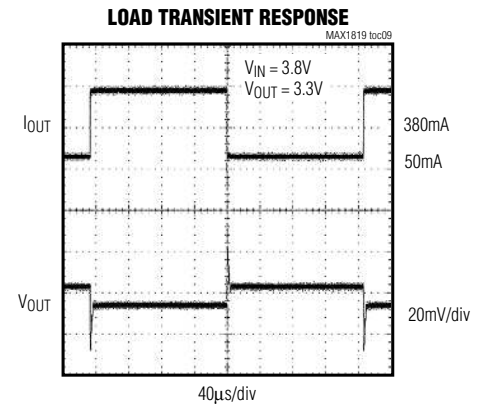
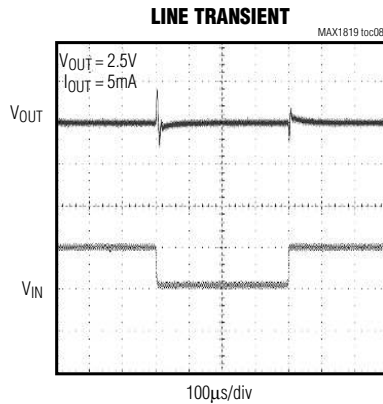
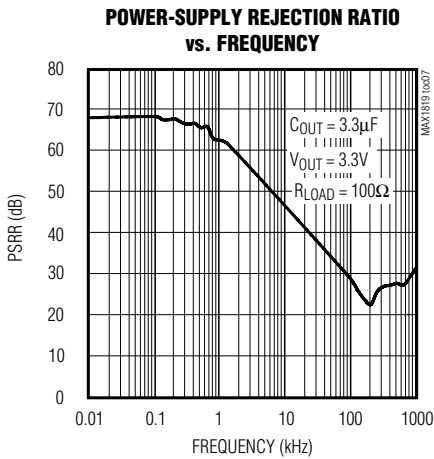
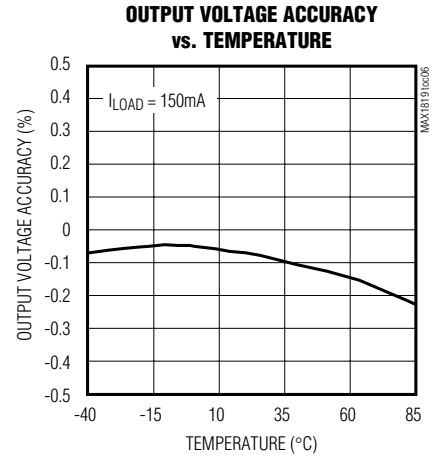
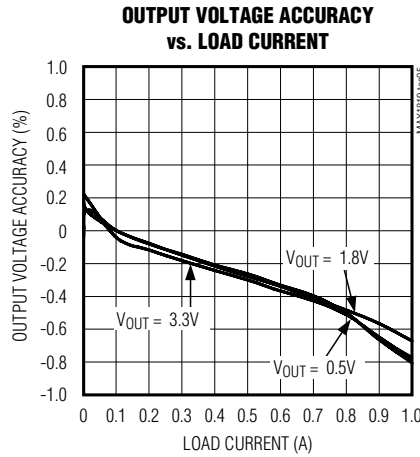
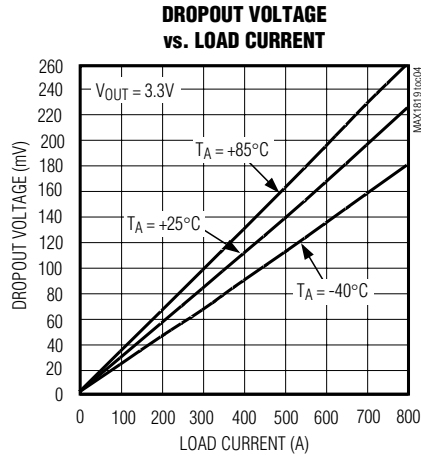

500mA Low-Dropout Linear Regulator in UCSP

MAX1819

Typical Operating Characteristics (continued)

($V_{IN} = (V_{OUT} + 500\text{mV})$ or 2.5V , whichever is greater; $\overline{\text{SHDN}} = \text{IN}$, $C_{IN} = 3.3\mu\text{F}$, $C_{OUT} = 3.3\mu\text{F}$, $T_A = +25^\circ\text{C}$, unless otherwise noted)

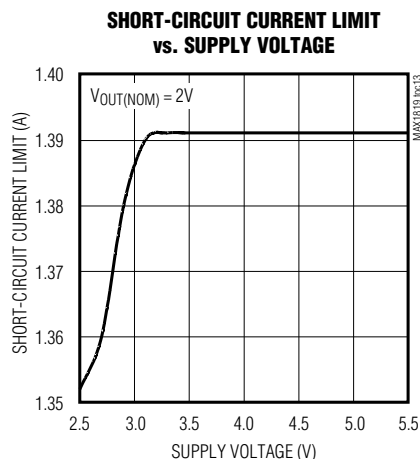
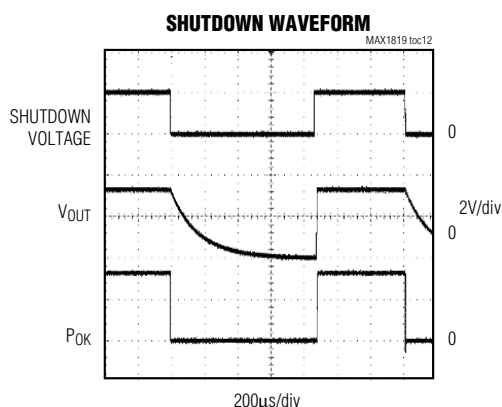

Pin Description

PIN	NAME	FUNCTION
A1	IN	Regulator Input. Supply voltage can range from 2.5V to 5.5V. Bypass with a 1µF capacitor to GND (see the <i>Capacitor Selection and Regulator Stability</i> section).
A2	POK	Open-Drain POK Output. POK remains low while the output voltage (V_{OUT}) is below the POK threshold. Connect a 100kΩ pullup resistor from POK to OUT to obtain an output voltage.
A3	$\overline{\text{SHDN}}$	Active-Low Shutdown Input. A logic low reduces supply current below 15µA. In shutdown, the POK and OUT are low. Connect to IN for normal operation.
C1	OUT	Regulator Output. Sources up to 500mA. Bypass with a 3.3µF low-ESR capacitor to GND. Use a 4.7µF capacitor for output voltages below 2V.
C2	SET	Voltage-Setting Input. Connect to GND for preset output. Connect to a resistive voltage-divider between OUT and GND to set the output voltage between 1.25V and 5V.
C3	GND	Ground

Detailed Description

The MAX1819 is a low-dropout, low-quiescent-current linear regulator designed primarily for battery-powered applications. The device supplies loads up to 500mA and is available with preset output voltages. As illustrated in Figure 1, the MAX1819 consists of a 1.25V reference, error amplifier, P-channel pass transistor, and internal feedback voltage-divider.

The 1.25V reference is connected to the error amplifier, which compares this reference with the feedback voltage and amplifies the difference. If the feedback voltage is lower than the reference voltage, the pass-transistor

gate is pulled lower, which allows more current to pass to the output and increases the output voltage. If the feedback voltage is too high, the pass-transistor gate is pulled up, allowing less current to pass to the output.

The output voltage is fed back through either an internal resistive-divider connected to OUT or an external resistor network connected to SET. The Dual Mode comparator examines V_{SET} and selects the feedback path. If V_{SET} is below 50mV, the internal feedback path is used and the output is regulated to the factory-preset voltage.

500mA Low-Dropout Linear Regulator in UCSP

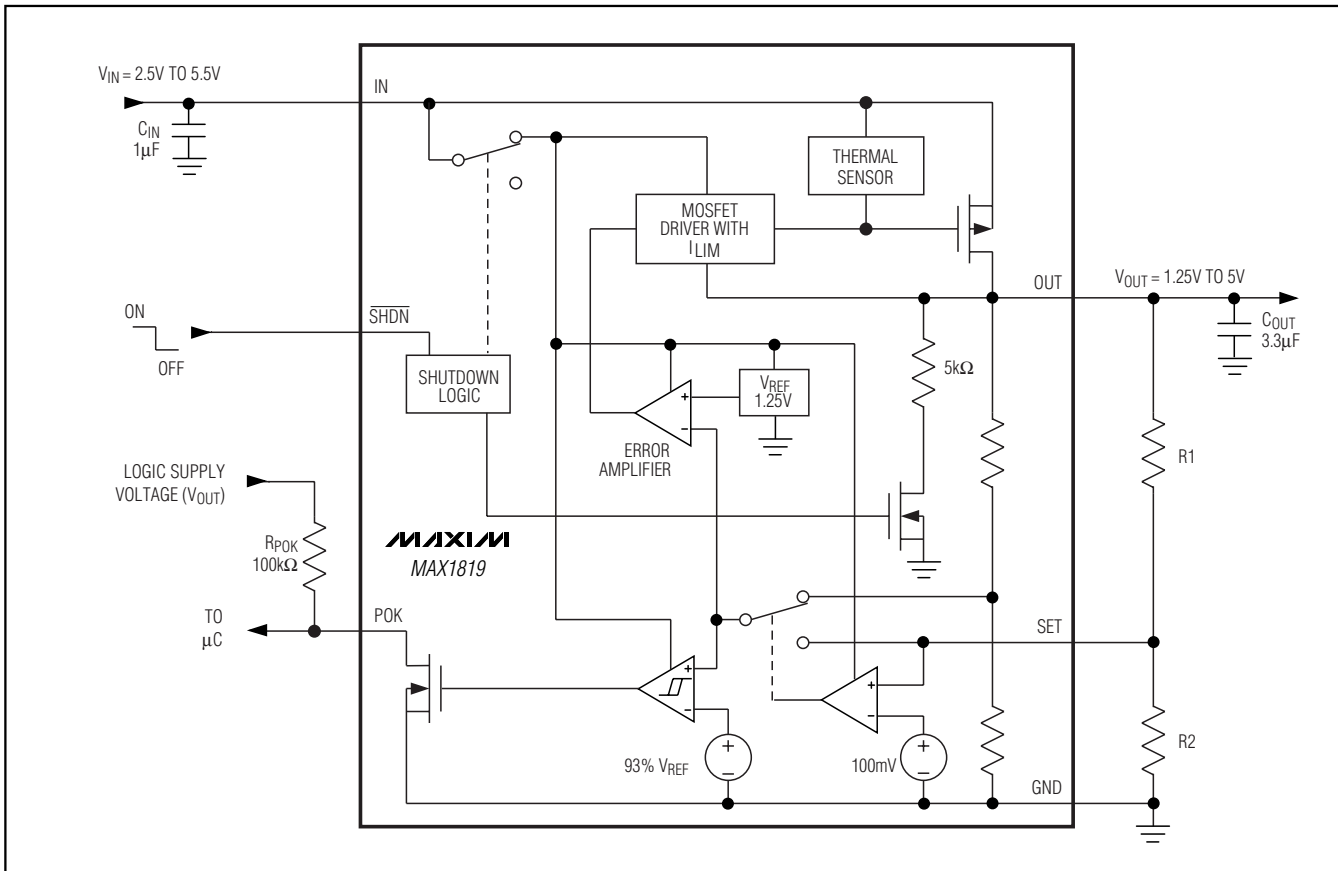

Figure 1. Functional Diagram

Additional blocks include an output current limiter, thermal sensor, and shutdown logic.

Internal P-Channel Pass Transistor

The MAX1819 features a 0.25Ω P-channel MOSFET pass transistor. Unlike similar designs using PNP pass transistors, P-channel MOSFETs require no base drive, which reduces quiescent current. PNP-based regulators also waste considerable current in dropout when the pass transistor saturates and use high base-drive currents under large loads. The MAX1819 does not suffer from these problems and consumes only 125µA of quiescent current under heavy loads as well as in dropout.

Output Voltage Selection

The MAX1819's Dual Mode allows operation in either a preset voltage mode or an adjustable mode. Connect SET to GND to select the preset output voltage. The two-digit part number suffix identifies the output voltage

(see the *Selector Guide*). For example, the MAX1819EBL33 has a preset 3.3V output voltage.

The output voltage may also be adjusted by connecting a voltage-divider from OUT to SET to GND (Figure 2). Select R2 in the 25kΩ to 100kΩ range. Calculate R1 with the following equation:

$$R1 = R2 [(V_{OUT} / V_{SET}) - 1]$$

where $V_{SET} = 1.25V$, and V_{OUT} may range from 1.25V to 5V.

Shutdown

Pull \overline{SHDN} low to enter shutdown. During shutdown, the output is disconnected from the input and supply current drops to 0.1µA. When in shutdown, POK and OUT pull low. \overline{SHDN} can be pulled as high as 6V, regardless of the input and output voltage.

500mA Low-Dropout Linear Regulator in UCSP

MAX1819

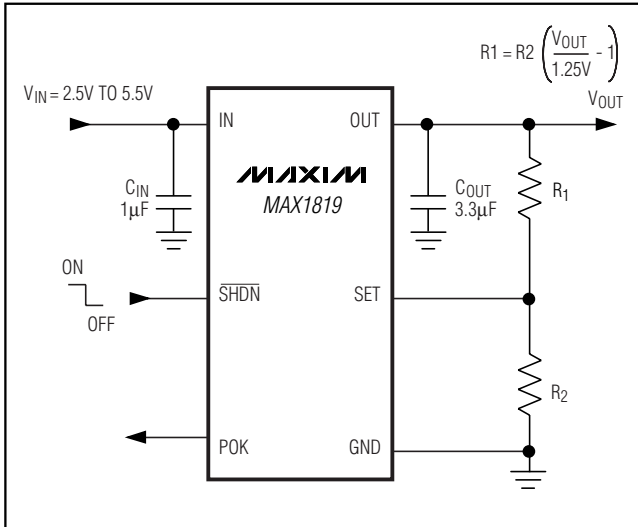

Figure 2. Adjustable Output Using External Feedback Resistors

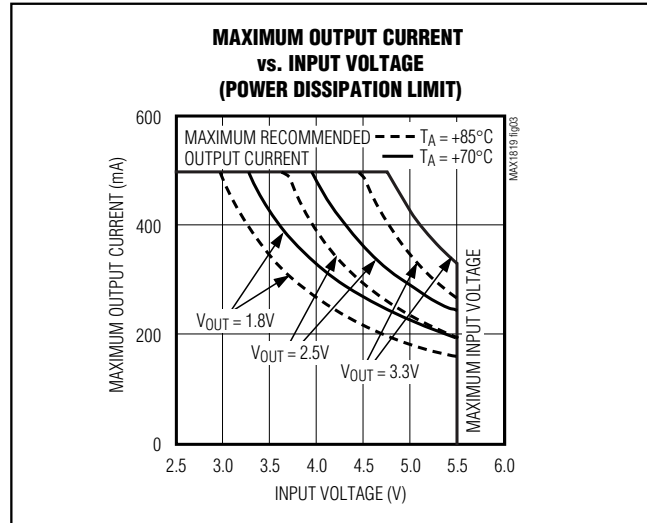

Figure 3. Power Operating Regions—Maximum Output vs. Supply Voltage

POK Output

The power-OK (POK) output pulls low when OUT is less than 93% of the nominal regulation voltage. Once OUT exceeds 93% of the nominal voltage, POK goes high impedance. POK is an open-drain N-channel output. To obtain a voltage signal, connect a pullup resistor from POK to OUT. A 100kΩ resistor works well for most applications. POK can be used as a power-OK signal to a microcontroller (µC), or drive an external LED to indicate power failure. When the MAX1819 is shut down, POK is held low independent of the output voltage. If unused, leave POK grounded or unconnected.

Current Limit

The MAX1819 monitors and controls the pass transistor's gate voltage, limiting the output current to 1.0A (typ). This current limit doubles when the output voltage is within 4% of the nominal value to improve performance with large load transients.

Thermal Overload Protection

Thermal overload protection limits total power dissipation in the MAX1819. When the junction temperature exceeds $T_J = +170^\circ\text{C}$, a thermal sensor turns off the pass transistor, allowing the IC to cool. The thermal sensor turns the pass transistor on again after the junction temperature cools by 20°C , resulting in a pulsed output during continuous thermal overload conditions. Thermal overload protection protects the MAX1819 in the event of fault conditions. For continuous operation, do not exceed the absolute maximum junction-temperature rating of $T_J = +150^\circ\text{C}$.

Operating Region and Power Dissipation

The MAX1819's maximum power dissipation depends on the thermal resistance of the IC package and circuit board, the temperature difference between the die junction and ambient air, and the rate of air flow. The power dissipated in the device is $P = I_{OUT} \times (V_{IN} - V_{OUT})$. The maximum allowed power dissipation is 840mW at $T_A = +70^\circ\text{C}$ or:

$$P_{MAX} = (T_{J(MAX)} - T_A) / (\theta_{JB} + \theta_{BA})$$

where $T_J - T_A$ is the temperature difference between the MAX1819 die junction and the surrounding air, θ_{JB} is the thermal resistance of the junction to the base, and θ_{BA} is the thermal resistance through the PC board, copper traces, and other materials to the surrounding air. For best heatsinking, the copper area should be equally shared between the IN, OUT, and GND pins.

The MAX1819 delivers up to 0.5A RMS and operates with input voltages up to 5.5V, but not simultaneously. High output currents can only be sustained when input-output differential voltages are low, as shown in Figure 3.

500mA Low-Dropout Linear Regulator in UCSP

Applications Information

Capacitor Selection and Regulator Stability

Capacitors are required at the MAX1819's input and output for stable operation over the full temperature range and with load currents up to 500mA. Connect a 1 μ F capacitor between IN and ground and a 3.3 μ F low-ESR capacitor between OUT and ground. For output voltages less than 2V, use a 4.7 μ F low-ESR output capacitor. The input capacitor (C_{IN}) lowers the source impedance of the input supply. Reduce noise and improve load-transient response, stability, and power-supply rejection by using larger output capacitors, such as 10 μ F.

The output capacitor's (C_{OUT}) equivalent series resistance (ESR) affects stability and output noise. Use output capacitors with an ESR of 0.1 Ω or less to ensure stability and optimum transient response. Surface-mount ceramic capacitors have very low ESR and are commonly available in values up to 10 μ F. C_{IN} and C_{OUT} use short traces to connect to the MAX1819.

Noise, PSRR, and Transient Response

The MAX1819 is designed to operate with low dropout voltages and low quiescent currents in battery-powered systems while still maintaining good noise, transient response, and AC rejection. See the *Typical Operating Characteristics* for a plot of Power-Supply Rejection Ratio (PSRR) vs. Frequency. When operating from noisy sources, improved supply-noise rejection and transient response can be achieved by increasing the values of the input and output bypass capacitors and through passive filtering techniques.

The MAX1819 load-transient response (see the *Typical Operating Characteristics*) shows two components of the output response: a DC shift from the output impedance due to the load current change, and the transient response. Increasing the output capacitor's value and decreasing the ESR attenuates the overshoot.

Input-Output (Dropout) Voltage

A regulator's minimum input-to-output voltage differential (dropout voltage) determines the lowest usable supply voltage. In battery-powered systems, this determines the useful end-of-life battery voltage. Because the MAX1819 uses a P-channel MOSFET pass transistor, its dropout voltage is a function of drain-to-source on-resistance ($R_{DS(ON)}$) multiplied by the load current (see the *Typical Operating Characteristics*).

$$V_{DROPOUT} = V_{IN} - V_{OUT} = R_{DS(ON)} \times I_{OUT}$$

The MAX1819 ground current remains at approximately 150 μ A in dropout.

Chip Information

TRANSISTOR COUNT: 845

500mA Low-Dropout Linear Regulator in UCSP

Package Information

(The package drawing(s) in this data sheet may not reflect the most current specifications. For the latest package outline information, go to www.maxim-ic.com/packages.)

MAX1819

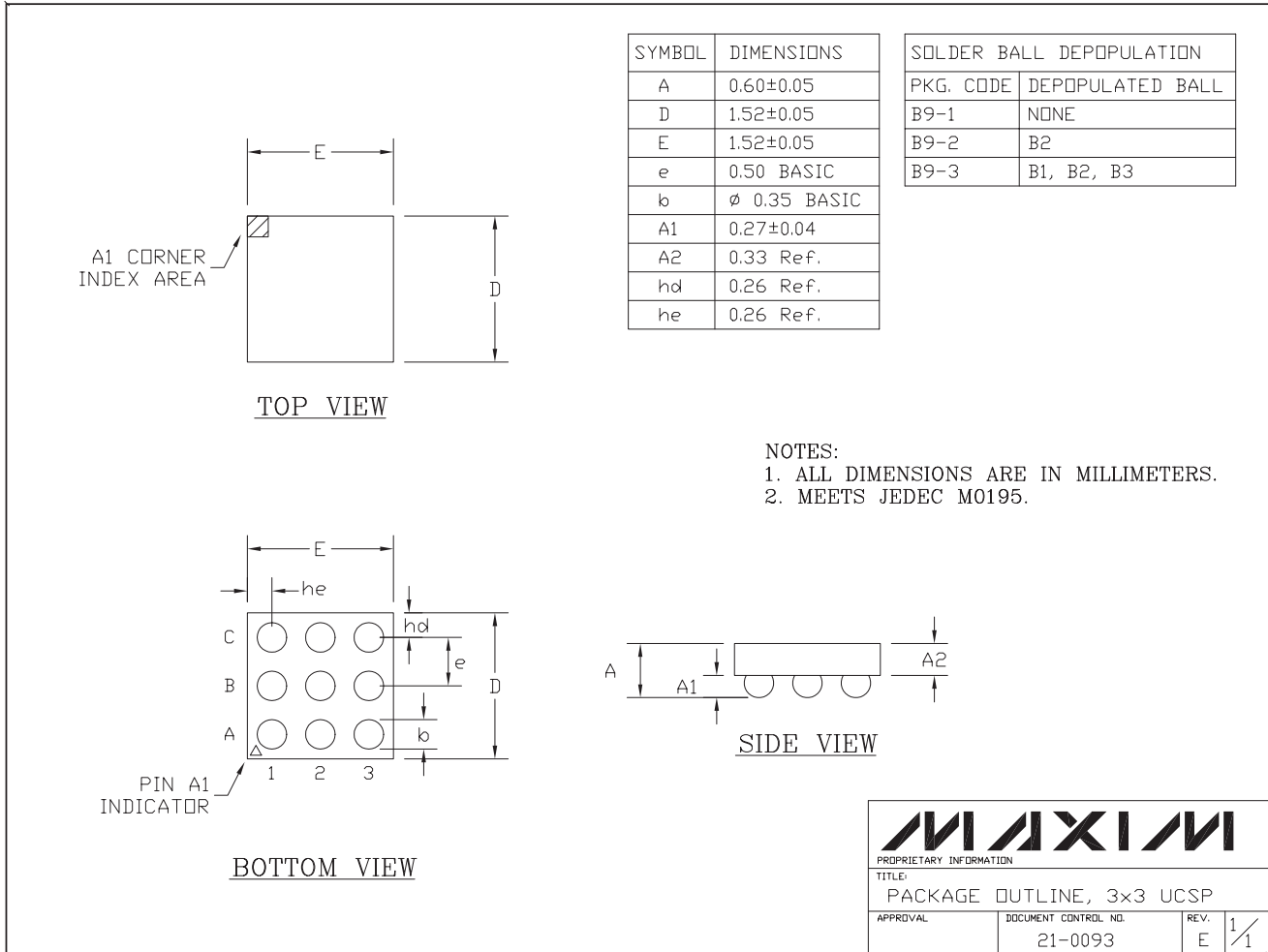

Maxim cannot assume responsibility for use of any circuitry other than circuitry entirely embodied in a Maxim product. No circuit patent licenses are implied. Maxim reserves the right to change the circuitry and specifications without notice at any time.

Maxim Integrated Products, 120 San Gabriel Drive, Sunnyvale, CA 94086 408-737-7600 _____ **9**