

AN-1678 LM3103 Demonstration Board Reference Design

1 Introduction

The LM3103 Step Down Switching Regulator features all required functions to implement a cost effective, efficient buck power converter capable of supplying 0.75A to loads. The Constant On-Time (COT) regulation scheme requires no loop compensation, results in a fast load transient response and simple circuit implementation which allows a low component count, and consequently very small overall board space is required for a typical application. The regulator can function properly even with an all ceramic output capacitor network, and does not rely on the output capacitor's ESR for stability. The operating frequency remains constant with line variations due to the inverse relationship between the input voltage and the on-time. Protection features include output over-voltage protection, thermal shutdown, V_{CC} under-voltage lock-out, gate drive under-voltage lock-out. The LM3103 is available in the thermally enhanced HTSSOP-16 package.

2 Demonstration Board Schematic and PCB

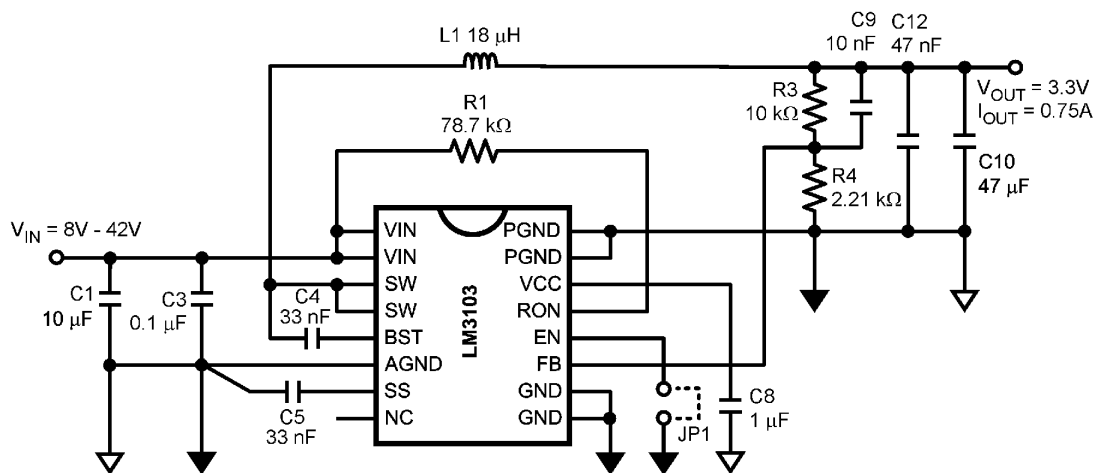

Figure 1. LM3103 Demonstration Board Schematic

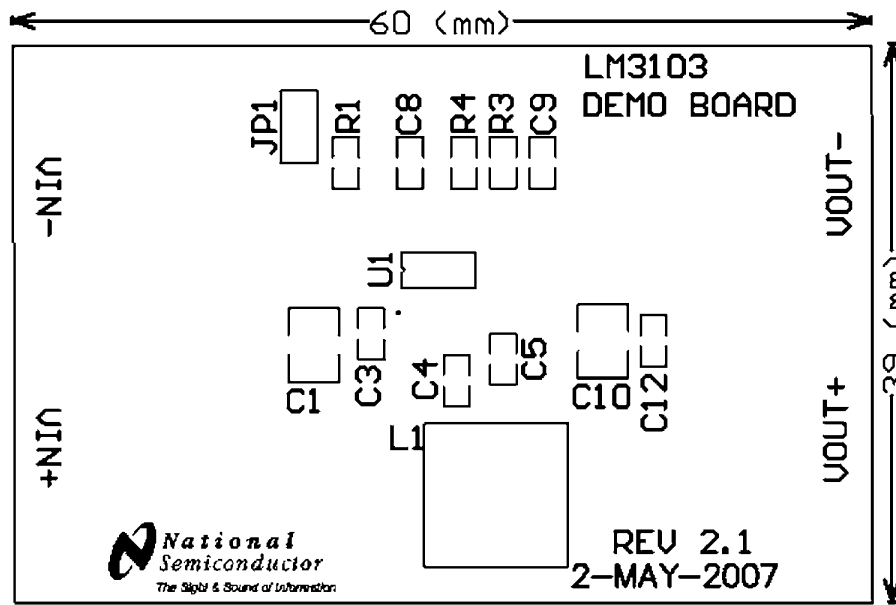

Figure 2. LM3103 Demonstration Board PCB Top Overlay

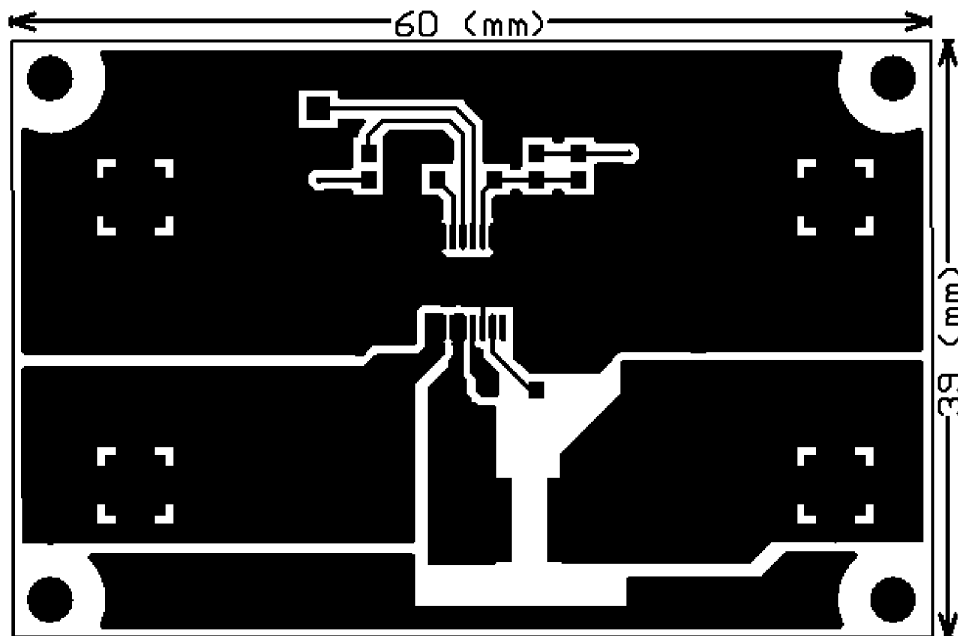
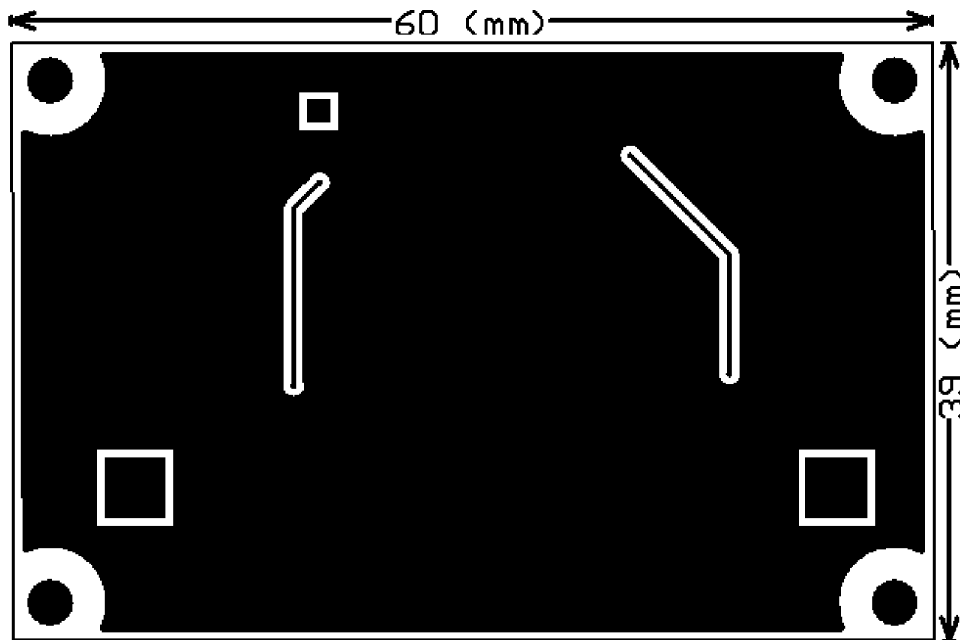

Figure 3. LM3103 Demonstration Board PCB Top View

Figure 4. LM3103 Demonstration Board PCB Bottom View
Table 1. Demonstration Board Quick Setup Procedures

Step	Description	Notes
1	Connect a power supply to VIN terminals	V_{IN} range: 8V to 42V
2	Connect a load to VOUT terminals	I_{OUT} range: 0A to 0.75A
3	SD (JP1) should be left open for normal operation. Short this jumper to shutdown	
4	Set $V_{IN} = 18V$, with 0A load applied, check V_{OUT} with a voltmeter	Nominal 3.3V
5	Apply 0.75A load and check V_{OUT}	Nominal 3.3V
6	Short output terminals and check the short circuit current with an ammeter	Nominal 1.05A
7	Short SD (JP1) to check the shutdown function	

Table 2. Demonstration Board Performance Characteristic

Description	Symbol	Condition	Min	Typ	Max	Unit
Input Voltage	V_{IN}		8	18	42	V
Output Voltage	V_{OUT}		3.2	3.3	3.4	V
Output Current	I_{OUT}		0	-	0.75	A
Output Voltage Ripple	$V_{OUT(Ripple)}$		-	-	50	mVp-p
Output Voltage Regulation	ΔV_{OUT}	ALL V_{IN} and I_{OUT} Conditions	-2		+2	%
Efficiency		$V_{IN} = 8V$	85		91	%
		$V_{IN} = 24V$	71		84	%
		$V_{IN} = 42V$ ($I_{OUT} = 0.1A$ to 0.75A)	59		78	%
Output Short Current Limit	I_{LIM-SC}			1.05		A

3 Design Procedure

The LM3103 is easy to use compared with other devices available on the market because it integrates all key components, including both the main and synchronous power MOSFETs, in a single package and requires no loop compensation owing to the use of the Constant On-Time (COT) hysteretic control scheme. The design of the demonstration board in this application note is detailed below.

Design Parameters:

$$V_{IN} = 8V \text{ to } 42V, \text{ typical } 18V$$

$$V_{OUT} = 3.3V$$

$$I_{OUT} = 0.75A$$

Step 1: Calculate the feedback resistors

The ratio of the feedback resistor can be calculated from the following equation:

$$\frac{R3}{R4} = \frac{V_{OUT}}{0.6} - 1 \quad (1)$$

As a general practice, R3 and R4 should be chosen from standard 1% resistor values in the range of 1.0 k Ω to 10 k Ω satisfying the above ratio. Now, select R3 = 10 k Ω , with $V_{OUT} = 3.3V$,

$$R4 = \frac{10 \text{ k}\Omega}{\left(\frac{V_{OUT}}{0.6} - 1\right)} = 2.22 \text{ k}\Omega \quad (2)$$

Step 2: Calculate the on-time setting resistor

The switching frequency f_{SW} of the demonstration board is affected by the on-time t_{on} of the LM3103, which is determined by R1. If f_{SW} and V_{OUT} are determined, R1 can be calculated as follows:

$$R1 = \frac{V_{OUT}}{8.3 \times 10^{-11} \times f_{SW}} \quad (3)$$

For this demonstration board design, $V_{OUT} = 3.3V$ and $f_{SW} = 500 \text{ kHz}$ are chosen. As a result, $R1 = 78.52 \text{ k}\Omega$. To ensure that the on-time is larger than the minimum limit, which is 100 ns, the value of R1 must satisfy the following equation:

$$R1 \geq \frac{V_{IN(MAX)} \times 100 \text{ ns}}{8.3 \times 10^{-11}} \quad (4)$$

Now the maximum V_{IN} is 42V, the calculated R1 satisfies the above equation.

Step 3: Determine the inductance

The main parameter affected by the inductor is the amplitude of the inductor current ripple I_{LR} . Once I_{LR} is selected, L1 can be determined by:

$$L1 = \frac{V_{OUT} \times (V_{IN} - V_{OUT})}{I_{LR} \times f_{SW} \times V_{IN}} \quad (5)$$

For this demonstration board design, $I_{LR} = 0.3A$ is selected. Now $V_{IN} = 18V$, $V_{OUT} = 3.3V$, and $f_{SW} = 500 \text{ kHz}$. As a result, $L = 17.97 \mu\text{H}$.

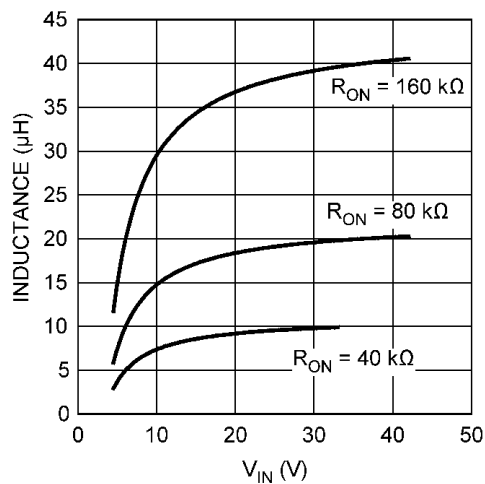

Figure 5. Inductor Selection for $V_{OUT} = 3.3V$

Step 4: Determine the value of other components

C1: The function of C1 is to supply most of the main MOSFET current during the on-time, and limit the voltage ripple at the VIN pin, assuming that the voltage source connecting to the VIN pin has finite output impedance. If the voltage source's dynamic impedance is high (effectively a current source), C1 supplies the average input current, but not the ripple current. At the maximum load current, when the main MOSFET turns on, the current to the VIN pin suddenly increases from zero to the lower peak of the inductor's ripple current and ramps up to the higher peak value. It then drops to zero at turn-off. The average current during the on-time is the load current. For a worst case calculation, C1 must be capable of supplying this average load current during the maximum on-time. C1 is calculated from:

$$C1 = \frac{I_{OUT} \times t_{on}}{\Delta V_{IN}} \quad (6)$$

where I_{OUT} is the load current, t_{on} is the maximum on-time, and ΔV_{IN} is the allowable ripple voltage at V_{IN} . In this demonstration board, a 10 μF capacitor is used.

C3: C3's purpose is to help avoid transients and ringing due to long lead inductance at the VIN pin. A low ESR 0.1 μF ceramic chip capacitor located close to the LM3103 is used in this demonstration board.

C4: A 33 nF high quality ceramic capacitor with low ESR is used for C4 since it supplies a surge current to charge the main MOSFET gate driver at turn-on. Low ESR also helps ensure a complete recharge during each off-time.

C5: The capacitor at the SS pin determines the soft-start time, i.e. the time for the reference voltage at the regulation comparator and the output voltage to reach their final value. The soft-start time is affected by the output capacitor, which can lengthen the time, and the charging of C5. The minimum soft-start time is determined by the following equation:

$$t_{SS} > 180 \mu s + \frac{C5 \times 0.6V}{70 \mu A} \quad (7)$$

In this demonstration board, a 33 nF capacitor is used for C5, and the corresponding soft-start time is about 600 μs .

C8: The capacitor on the V_{CC} output provides not only noise filtering and stability, but also prevents false triggering of the V_{CC} UVLO at the main MOSFET on/off transitions. C8 should be no smaller than 1 μF for stability, and should be a good quality, low ESR, ceramic capacitor.

C9: If the output voltage is higher than 1.6V, C9 is needed in the Discontinuous Conduction Mode to reduce the output ripple. In this demonstration board, a 10 nF capacitor is used.

C10: The output capacitor should generally be no smaller than 10 μF . Experiment is usually necessary to determine the minimum value for the output capacitor, as the nature of the load may require a larger value. A load which creates significant transients requires a larger output capacitor than a fixed load. In this demonstration board, a 47 μF capacitor is used to provide a low output ripple.

C12: C12 is a small value ceramic capacitor located close to the LM3103 to further suppress high frequency noise at V_{OUT} . A 47 nF capacitor is used in this demonstration board.

4 PC Board Layout

The LM3103 regulation, over-voltage, and current limit comparators are very fast so they will respond to short duration noise pulses. Layout is therefore critical for optimum performance. It must be as neat and compact as possible, and all external components must be as close to their associated pins of the LM3103 as possible. The loop formed by C1, the main and synchronous MOSFET internal to the LM3103, and the PGND pin should be as small as possible. The connection from the PGND pin to the input capacitors should be as short and direct as possible. Vias should be added to connect the ground of the input capacitors to a ground plane, located as close to the capacitor as possible. The bootstrap capacitor C4 should be connected as close to the SW and BST pins as possible, and the connecting traces should be thick. The feedback resistors and capacitor R3, R4, and C9 should be close to the FB pin. A long trace running from V_{OUT} to R3 is generally acceptable since this is a low impedance node. Ground R4 directly to the AGND pin (pin 7). The output capacitor C10 should be connected close to the load and tied directly to the ground plane. The inductor L1 should be connected close to the SW pin with as short a trace as possible to reduce the potential for EMI (electromagnetic interference) generation. If it is expected that the internal dissipation of the LM3103 will produce excessive junction temperature during normal operation, making good use of the PC board's ground plane can help considerably to dissipate heat. The exposed pad on the bottom of the LM3103 IC package can be soldered to the ground plane, which should extend out from beneath the LM3103 to help dissipate heat. The exposed pad is internally connected to the LM3103 IC substrate. Additionally the use of thick traces, where possible, can help conduct heat away from the LM3103. Using numerous vias to connect the die attached pad to the ground plane is a good practice. Judicious positioning of the PC board within the end product, along with the use of any available air flow (forced or natural convection) can help reduce the junction temperature.

5 Bill of Materials

Designation	Description	Size	Manufacturer Part #	Vendor
C1	Cap 10 μF 50V Y5V	1210	GRM32DF51H106ZA01L	Murata
C3	0603/X7R/0.1 μF /50V	0603	ECJ1VB1H104K	Panasonic
C4, C5	0603/X7R/33000pF/50V	0603	ECJ1VB1H333K	Panasonic
C8	0603/X5R/1 μF /10V	0603	GRM188R61A105KA61B	Murata
C9	0603/X7R/10000pF/50V	0603	ECJ1VB1H103K	Panasonic
			GRM188R71H103KA01B	Murata
C10	1210/X5R/47 μF /6.3V	1210	ECJ4YB0J476M	Panasonic
			GRM32ER60J476ME20B	Murata
C12	0603/X7R/47000pF/50V	0603	ECJ1VB1H473K	Panasonic
R1	Resistor Chip 78.7k Ω F	0603	CRCW06037872F	Vishay
R3	Resistor Chip 10k Ω F	0603	CRCW06031002F	Vishay
R4	Resistor Chip 2.21k Ω F	0603	CRCW06032211F	Vishay
L1	Power Inductor 18 μH 1.45A	6.8x6.8x3	CDR6D28MNNP-180NC	Sumida
	Power Inductor 18 μH 1.7A	7.3x7.3x3.2	7447789118	Wurth
U1	IC LM3103	HTSSOP-16	LM3103	Texas Instruments
PCB	LM3103 demo board			Texas Instruments

6 Typical Performance and Waveforms

All curves and waveforms are taken at $V_{IN} = 18V$ with the demonstration board and $T_A = 25^\circ C$ unless otherwise specified.

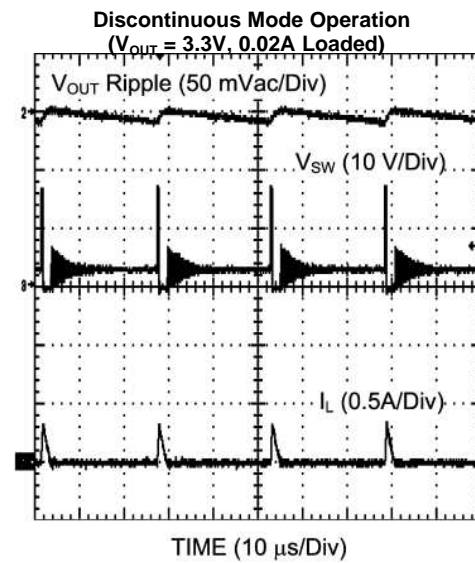
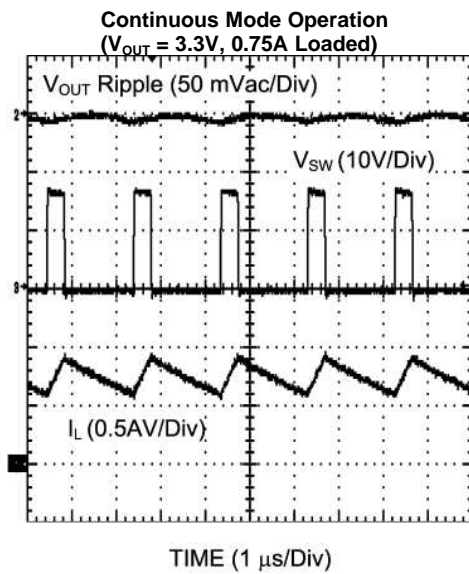
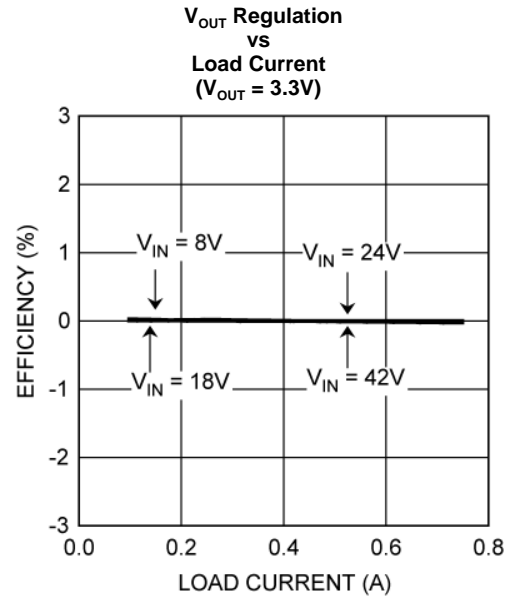
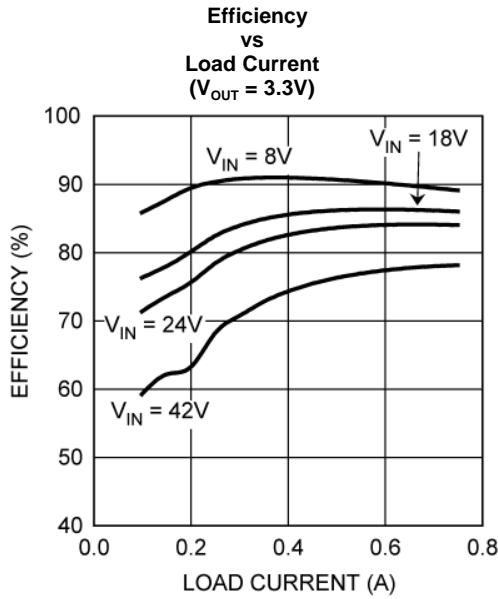

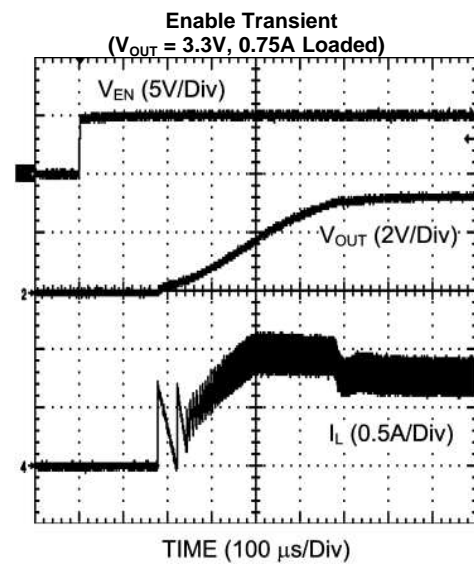
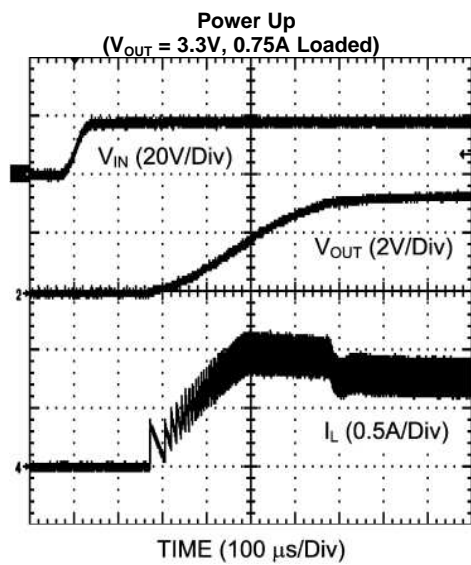
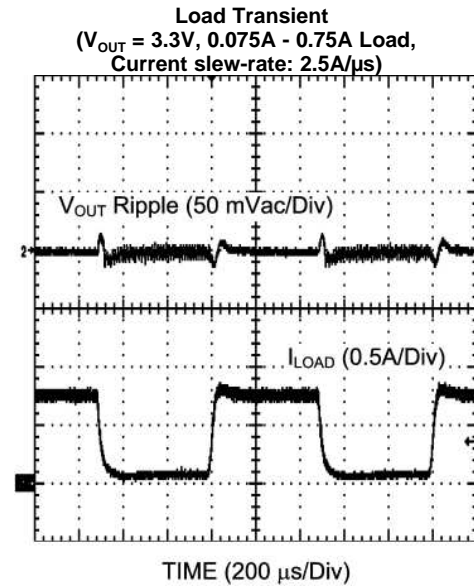
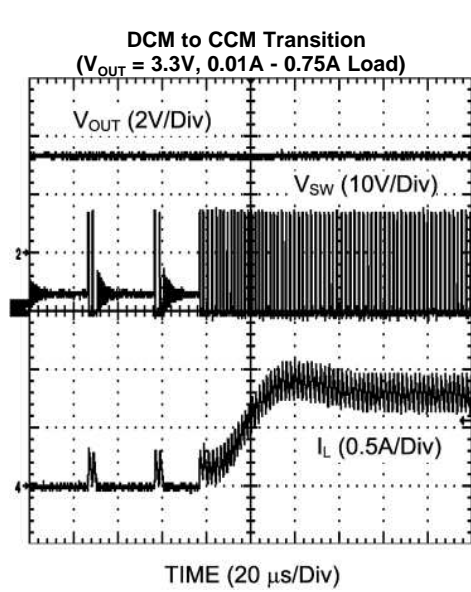

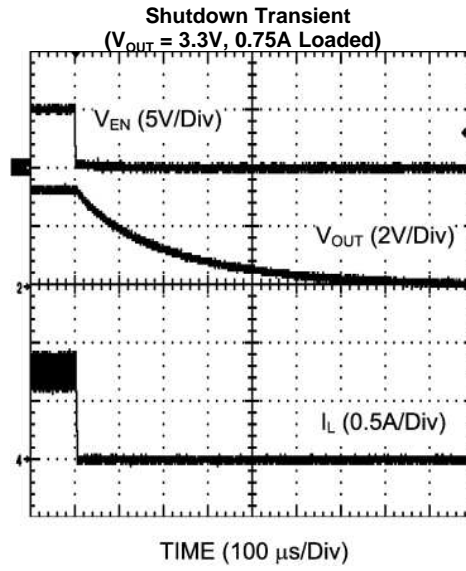

IMPORTANT NOTICE

Texas Instruments Incorporated and its subsidiaries (TI) reserve the right to make corrections, enhancements, improvements and other changes to its semiconductor products and services per JESD46, latest issue, and to discontinue any product or service per JESD48, latest issue. Buyers should obtain the latest relevant information before placing orders and should verify that such information is current and complete. All semiconductor products (also referred to herein as "components") are sold subject to TI's terms and conditions of sale supplied at the time of order acknowledgment.

TI warrants performance of its components to the specifications applicable at the time of sale, in accordance with the warranty in TI's terms and conditions of sale of semiconductor products. Testing and other quality control techniques are used to the extent TI deems necessary to support this warranty. Except where mandated by applicable law, testing of all parameters of each component is not necessarily performed.

TI assumes no liability for applications assistance or the design of Buyers' products. Buyers are responsible for their products and applications using TI components. To minimize the risks associated with Buyers' products and applications, Buyers should provide adequate design and operating safeguards.

TI does not warrant or represent that any license, either express or implied, is granted under any patent right, copyright, mask work right, or other intellectual property right relating to any combination, machine, or process in which TI components or services are used. Information published by TI regarding third-party products or services does not constitute a license to use such products or services or a warranty or endorsement thereof. Use of such information may require a license from a third party under the patents or other intellectual property of the third party, or a license from TI under the patents or other intellectual property of TI.

Reproduction of significant portions of TI information in TI data books or data sheets is permissible only if reproduction is without alteration and is accompanied by all associated warranties, conditions, limitations, and notices. TI is not responsible or liable for such altered documentation. Information of third parties may be subject to additional restrictions.

Resale of TI components or services with statements different from or beyond the parameters stated by TI for that component or service voids all express and any implied warranties for the associated TI component or service and is an unfair and deceptive business practice. TI is not responsible or liable for any such statements.

Buyer acknowledges and agrees that it is solely responsible for compliance with all legal, regulatory and safety-related requirements concerning its products, and any use of TI components in its applications, notwithstanding any applications-related information or support that may be provided by TI. Buyer represents and agrees that it has all the necessary expertise to create and implement safeguards which anticipate dangerous consequences of failures, monitor failures and their consequences, lessen the likelihood of failures that might cause harm and take appropriate remedial actions. Buyer will fully indemnify TI and its representatives against any damages arising out of the use of any TI components in safety-critical applications.

In some cases, TI components may be promoted specifically to facilitate safety-related applications. With such components, TI's goal is to help enable customers to design and create their own end-product solutions that meet applicable functional safety standards and requirements. Nonetheless, such components are subject to these terms.

No TI components are authorized for use in FDA Class III (or similar life-critical medical equipment) unless authorized officers of the parties have executed a special agreement specifically governing such use.

Only those TI components which TI has specifically designated as military grade or "enhanced plastic" are designed and intended for use in military/aerospace applications or environments. Buyer acknowledges and agrees that any military or aerospace use of TI components which have **not** been so designated is solely at the Buyer's risk, and that Buyer is solely responsible for compliance with all legal and regulatory requirements in connection with such use.

TI has specifically designated certain components as meeting ISO/TS16949 requirements, mainly for automotive use. In any case of use of non-designated products, TI will not be responsible for any failure to meet ISO/TS16949.

Products

Audio	www.ti.com/audio
Amplifiers	amplifier.ti.com
Data Converters	dataconverter.ti.com
DLP® Products	www.dlp.com
DSP	dsp.ti.com
Clocks and Timers	www.ti.com/clocks
Interface	interface.ti.com
Logic	logic.ti.com
Power Mgmt	power.ti.com
Microcontrollers	microcontroller.ti.com
RFID	www.ti-rfid.com
OMAP Applications Processors	www.ti.com/omap
Wireless Connectivity	www.ti.com/wirelessconnectivity

Applications

Automotive and Transportation	www.ti.com/automotive
Communications and Telecom	www.ti.com/communications
Computers and Peripherals	www.ti.com/computers
Consumer Electronics	www.ti.com/consumer-apps
Energy and Lighting	www.ti.com/energy
Industrial	www.ti.com/industrial
Medical	www.ti.com/medical
Security	www.ti.com/security
Space, Avionics and Defense	www.ti.com/space-avionics-defense
Video and Imaging	www.ti.com/video

TI E2E Community

e2e.ti.com