

Power Inductor

APCA Series - ISO9001 | ISO14001 | IATF16949



Part Numbering

A	PCA	00	060645	1R0	T	00
Grade	Series Name	Control Code	Dimensions Code (mm)	Inductance (uH)	Tolerance	Internal Code
			060645 6.0x6.3x4.5	1R0 1.0	M ±20%	
			070745 7.0x7.4x4.5	100 10	T ±30%	
				101 100		

APCA00060645 Type

■ Dimensions

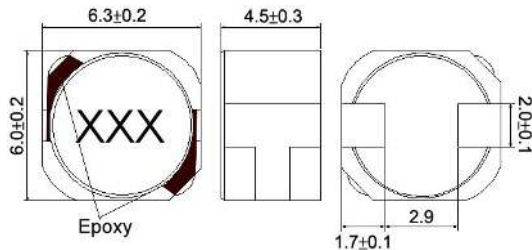

unit:mm

■ Recommended Land Pattern

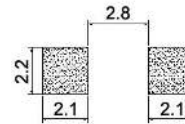

unit:mm

■ Electrical Characteristics

Part No.	Inductance (uH)	Test Freq.	RDC (Ω)Max.	Isat(A) Typ(Max)	Irms (A)	Tolerance (±%)	Marking
APCA000606451R0□00	1.0	100 kHz,1 V	0.0143	6.7(6.0)	4.8	30	1R0
APCA000606451R5□00	1.5	100 kHz,1 V	0.0169	5.5(5.2)	4.5	30	1R5
APCA000606452R2□00	2.2	100 kHz,1 V	0.0195	4.2(3.6)	4.1	30	2R2
APCA000606453R3□00	3.3	100 kHz,1 V	0.0247	3.5(3.2)	3.7	30	3R3
APCA000606454R7□00	4.7	100 kHz,1 V	0.0299	3.1(2.5)	3.3	30	4R7
APCA000606456R8□00	6.8	100 kHz,1 V	0.0351	2.8(2.0)	3.1	30	6R8
APCA00060645100□00	10	100 kHz,1 V	0.042	2.1(1.7)	2.6	20	100
APCA00060645150□00	15	100 kHz,1 V	0.072	1.7(1.4)	2.0	20	150
APCA00060645220□00	22	100 kHz,1 V	0.09	1.4(1.1)	1.8	20	220
APCA00060645330□00	33	100 kHz,1 V	0.12	1.1(0.9)	1.6	20	330
APCA00060645470□00	47	100 kHz,1 V	0.156	0.97(0.78)	1.4	20	470
APCA00060645680□00	68	100 kHz,1 V	0.24	0.81(0.65)	1.1	20	680
APCA00060645101□00	100	100 kHz,1 V	0.384	0.61(0.55)	0.86	20	101
APCA00060645151□00	150	100 kHz,1 V	0.576	0.53(0.46)	0.72	20	151
APCA00060645221□00	220	100 kHz,1 V	0.864	0.47(0.36)	0.57	20	221
APCA00060645331□00	330	100 kHz,1 V	1.104	0.36(0.28)	0.49	20	331
APCA00060645471□00	470	100 kHz,1 V	1.56	0.28(0.25)	0.41	20	471

Note: When ordering, please specify tolerance code. Tolerance: M=±20% / T=±30%

1. Operating temperature range - 40°C ~ 125°C(Including self - temperature rise)
2. Isat for Inductance drop 30% from its value without current
3. The actual use current is suggested not to be out of Isat*80%
4. I rms for a 40°C temperature rise from 25°C ambient.
5. Measure Equipment:
L: HP4284+42841A
RDC: Chroma 16502
Isat: HP4284+42841A

APCA00060645 Type

Characteristics Graph

Inductance vs. Frequency Characteristics

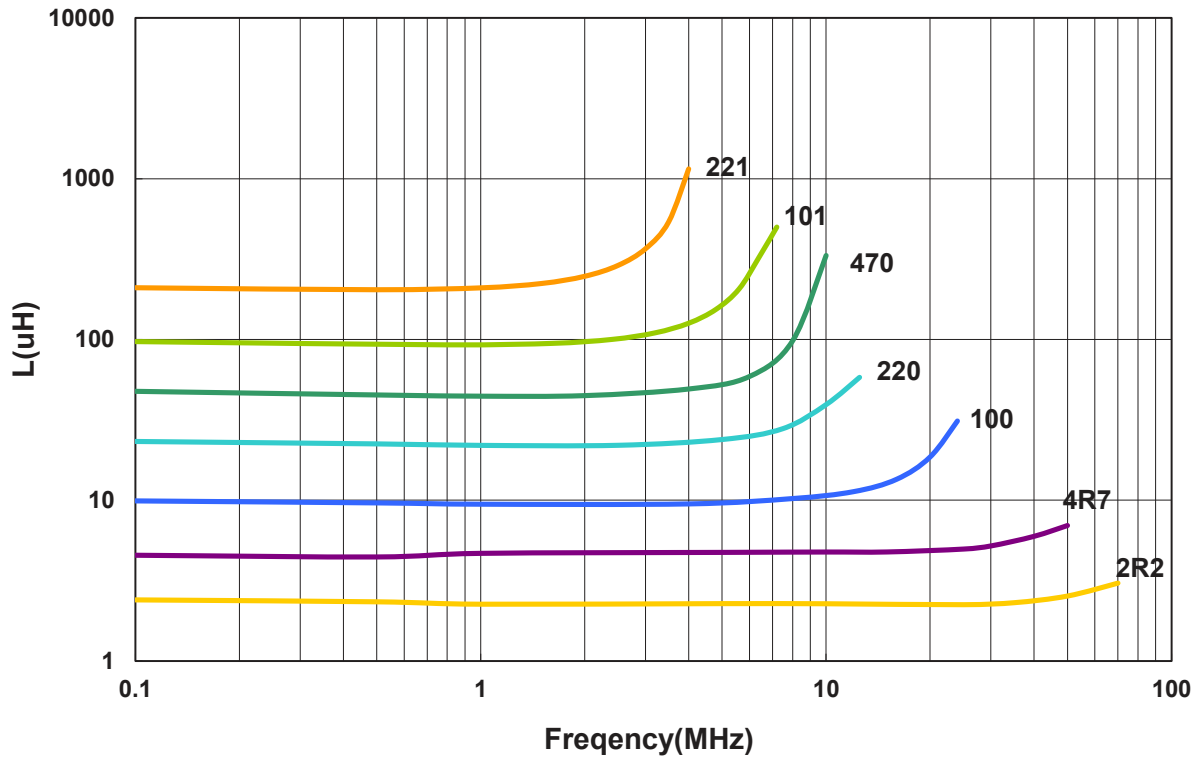

Inductance vs. DC Current

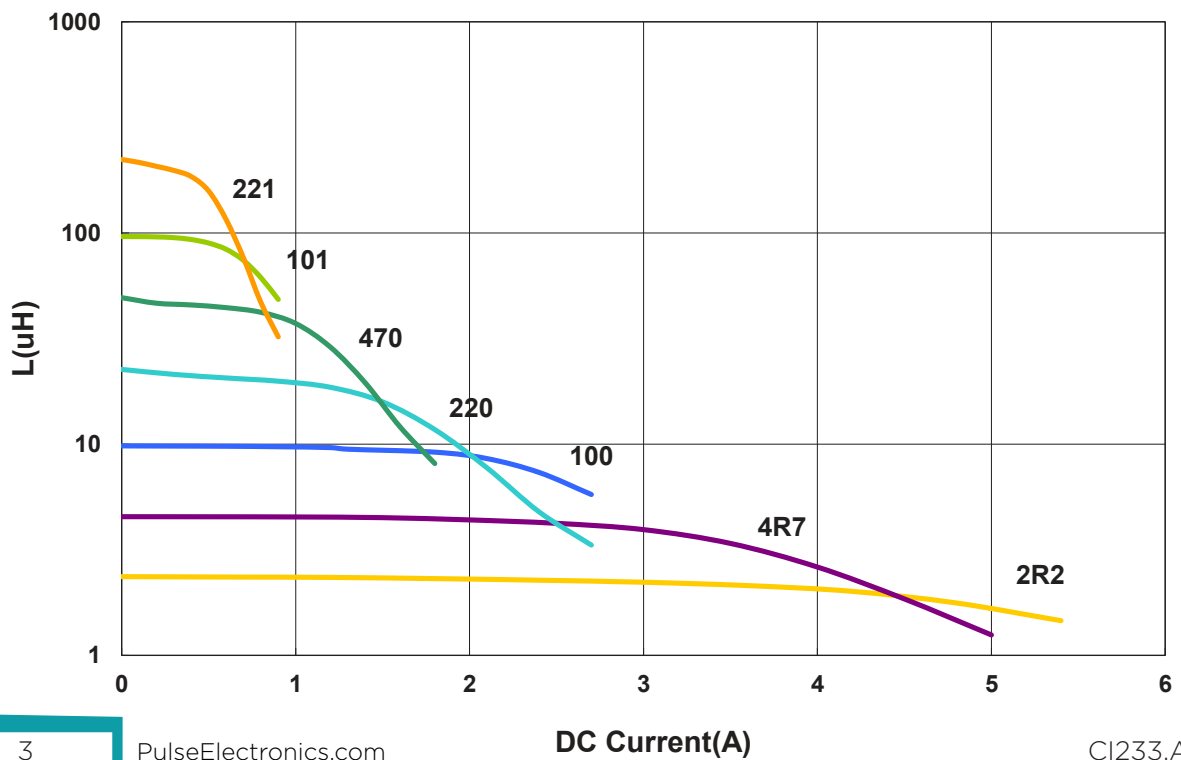

APCA00070745 Type

Dimensions

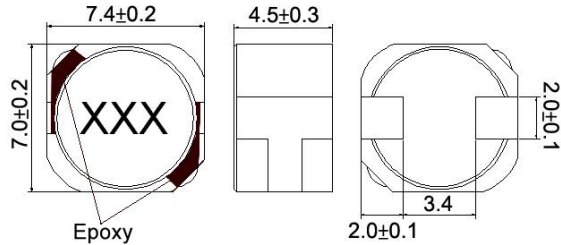

unit:mm

Recommended Land Pattern

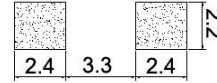

unit:mm

Electrical Characteristics

Part No.	Inductance (uH)	Test Freq.	RDC (Ω)Max.	Isat(A) Typ(Max)	Irms (A)	Tolerance (±%)	Marking
APCA000707451R0□00	1.0	100 kHz,1 V	0.0117	9.3(7.6)	6.5	30	1R0
APCA000707451R5□00	1.5	100 kHz,1 V	0.013	7.8(6.2)	5.4	30	1R5
APCA000707452R2□00	2.2	100 kHz,1 V	0.0169	7.3(6.0)	5.1	30	2R2
APCA000707453R3□00	3.3	100 kHz,1 V	0.0208	5.8(4.6)	4.8	30	3R3
APCA000707454R7□00	4.7	100 kHz,1 V	0.0234	4.8(4.0)	4.1	30	4R7
APCA000707456R8□00	6.8	100 kHz,1 V	0.0264	3.6(3.0)	3.9	30	6R8
APCA00070745100□00	10	100 kHz,1 V	0.0396	3.2(2.6)	3.1	20	100
APCA00070745150□00	15	100 kHz,1 V	0.066	2.4(2.0)	2.6	20	150
APCA00070745220□00	22	100 kHz,1 V	0.0828	2.1(1.6)	2.2	20	220
APCA00070745330□00	33	100 kHz,1 V	0.116	1.6(1.3)	1.8	20	330
APCA00070745470□00	47	100 kHz,1 V	0.156	1.3(1.1)	1.7	20	470
APCA00070745680□00	68	100 kHz,1 V	0.204	1.08(0.95)	1.5	20	680
APCA00070745101□00	100	100 kHz,1 V	0.312	0.9(0.8)	1.05	20	101
APCA00070745151□00	150	100 kHz,1 V	0.516	0.8(0.65)	0.95	20	151
APCA00070745221□00	220	100 kHz,1 V	0.66	0.7(0.54)	0.75	20	221
APCA00070745331□00	330	100 kHz,1 V	0.96	0.55(0.45)	0.58	20	331
APCA00070745471□00	470	100 kHz,1 V	1.44	0.45(0.37)	0.46	20	471

Note: When ordering, please specify tolerance code. Tolerance: M=±20% / T=±30%

1. Operating temperature range - 40°C ~ 125°C(Including self - temperature rise)
2. Isat for Inductance drop 30% from its value without current
3. The actual use current is suggested not to be out of Isat*80%
4. I rms for a 40°C temperature rise from 25°C ambient.
5. Measure Equipment:
L: HP4284+42841A
RDC: Chroma 16502
Isat: HP4284+42841A

APCA00070745 Type

Characteristics Graph

Inductance vs. Frequency Characteristics

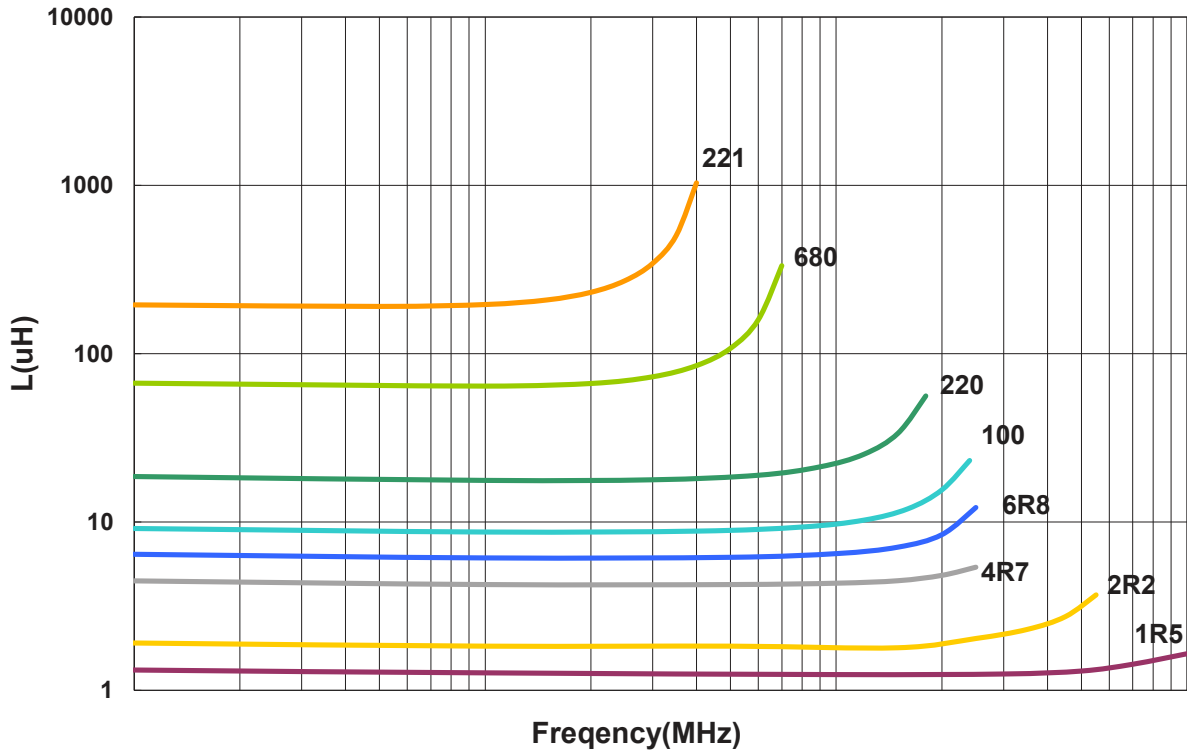

Inductance vs. DC Current Characteristics

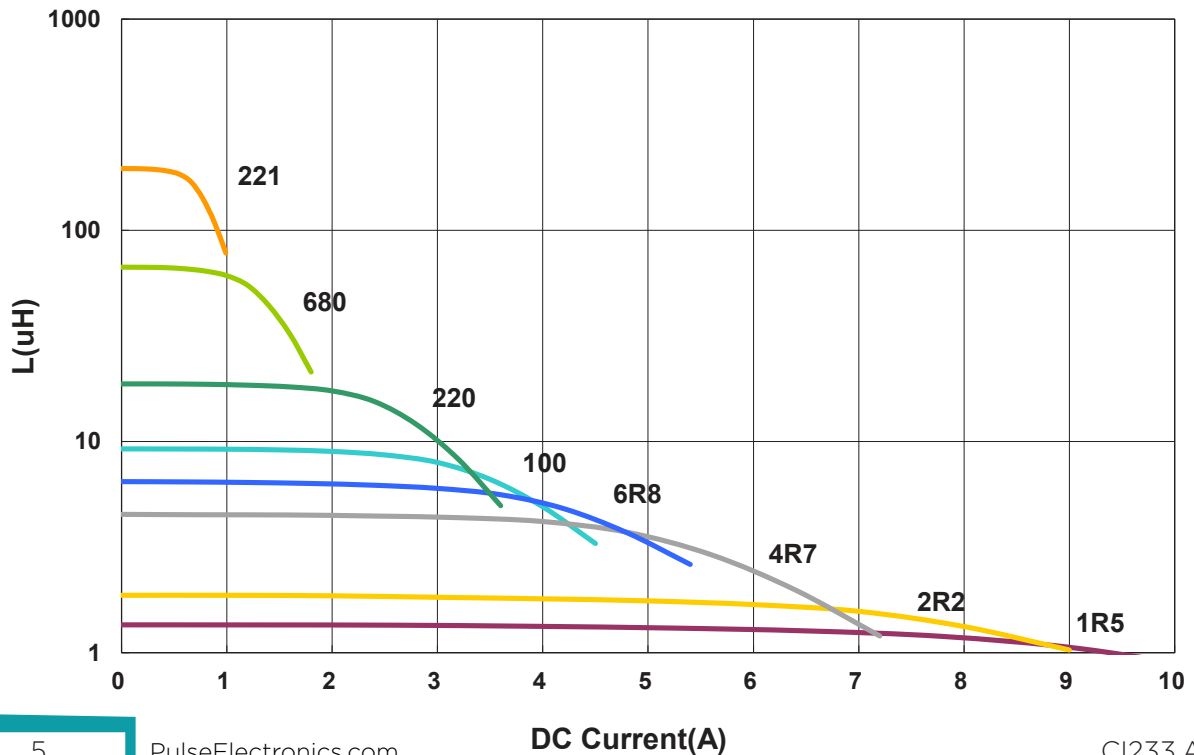

■ Packaging

Tape Dimensions

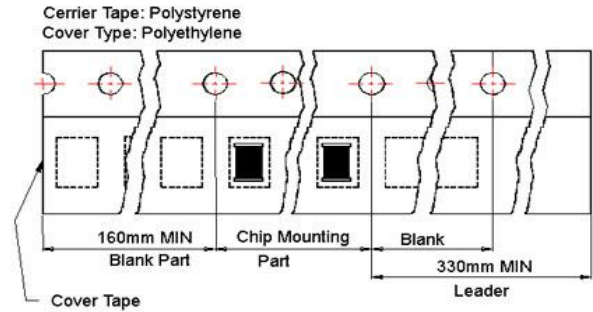
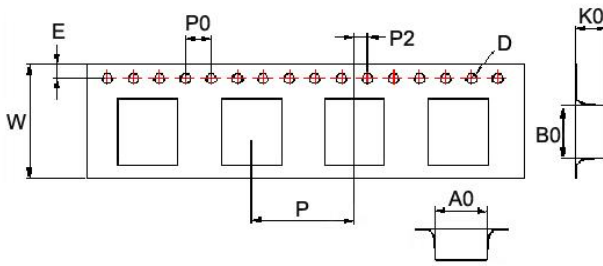

Reel Dimensions

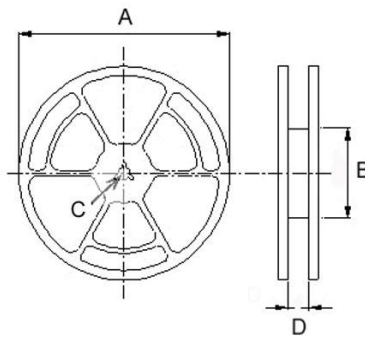

Dimensions in mm

TYPE	Tape Dimensions									Reel Dimensions				Quantity
	A0	B0	K0	D	E	W	P	P0	P2	A	B	C	D	PCS / REEL
APCA00060645	6.9	6.3	5	1.55	1.75	16	12	4	2	330	100	13	16	1000
APCA00070745	7.7	7.35	5	1.55	1.75	16	12	4	2	330	100	13	16	1000

For More Information:

Americas - prodinfo_power_americas@yageo.com | Europe - prodinfo_power_emea@yageo.com | Asia - prodinfo_power_asia@yageo.com

Performance warranty of products offered on this data sheet is limited to the parameters specified. Data is subject to change without notice. Other brand and product names mentioned herein may be trademarks or registered trademarks of their respective owners. © Copyright, 2022. Pulse Electronics, Inc. All rights reserved.