



■ ELECTRICAL SPECIFICATION

GPS ANTENNA

Parameters	Value	Unit
Frequency Range	1575.420 ±3	MHz
Band Width	CF ±5	MHz
Polarization	RHCP	-
Gain (Zenith)	2.0	dBic
VSWR, max	1.5	-
Impedance	50	Ω
Axial Ratio, max	3	dB

LNA

Parameters	Value	Unit
Gain, typ	28 ±2	dB
Noise Figure, max	1.5	dB
VSWR, max	2.0	-
Supply Voltage	2.2 ~ 5	VDC
Current Consumption, max	15	mA

GSM ANTENNA

Parameters	Value	Unit
Frequency Range	824 ~ 960 1710 ~ 2170	MHz
Polarization	Linear	-
Gain	2.0	dBi
VSWR, max	2.0	-
Impedance	50	Ω

WIFI ANTENNA

Parameters	Value	Unit
Frequency Range	2400 ~ 2483.5	MHz
Band Width	83.5	MHz
Polarization	Linear	-
Gain	3.0	dBi
VSWR, max	2.0	-
Impedance	50	Ω

MECHANICAL SPECIFICATION

Parameters		Value	Unit
Connector		SMA	-
Cable		RG174	-
Radome Material		ABS	-
Mounting Method		Screw	-
Operating Temperature Range		-40 ~ +85	°C
Relative Humidity, max		95	%
Ingress Protection	@ Exclude Cable Outlet	IP65 ~ IP66	-
Vibration	@ 1.5 mm amplitude 2hours	10 ~ 55	Hz
ROHS Compliant		YES	-

DIMENSIONS

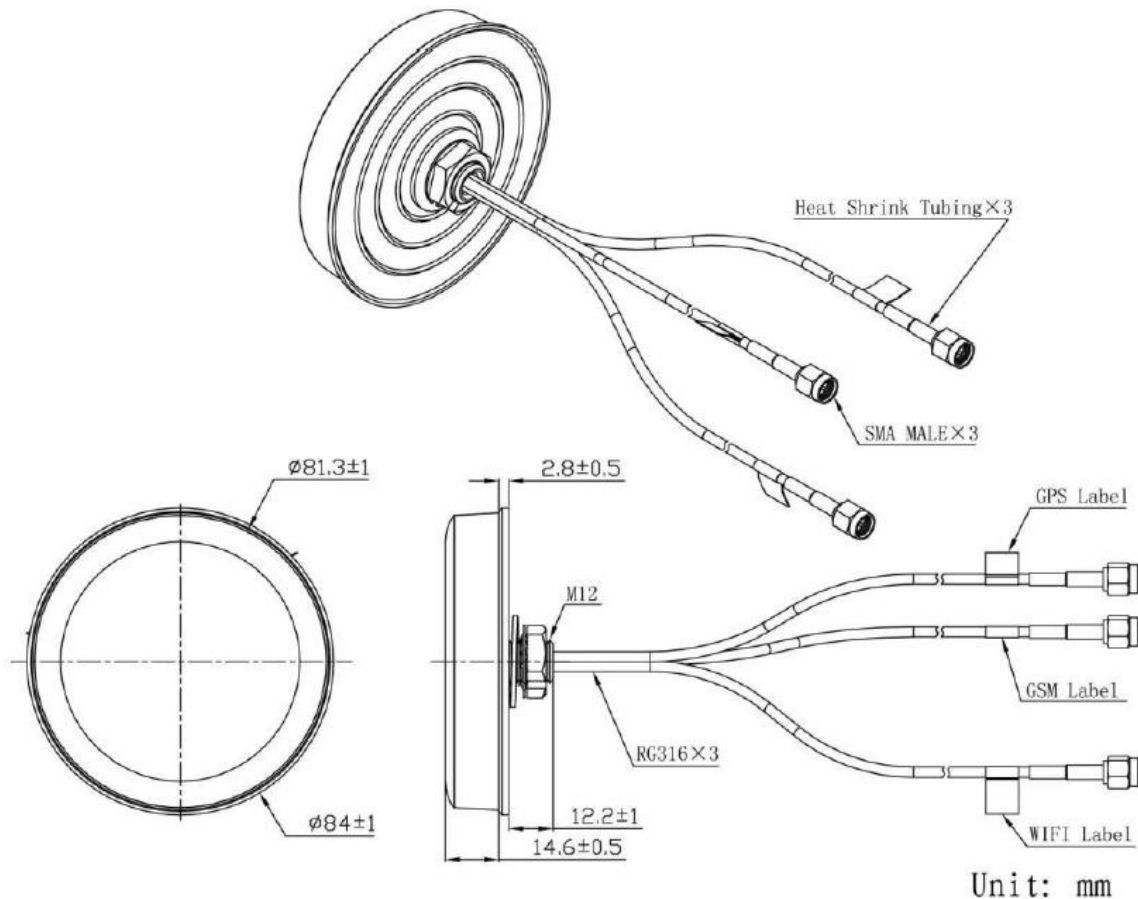

■ RADIATION PATTERN

GPS ANTENNA

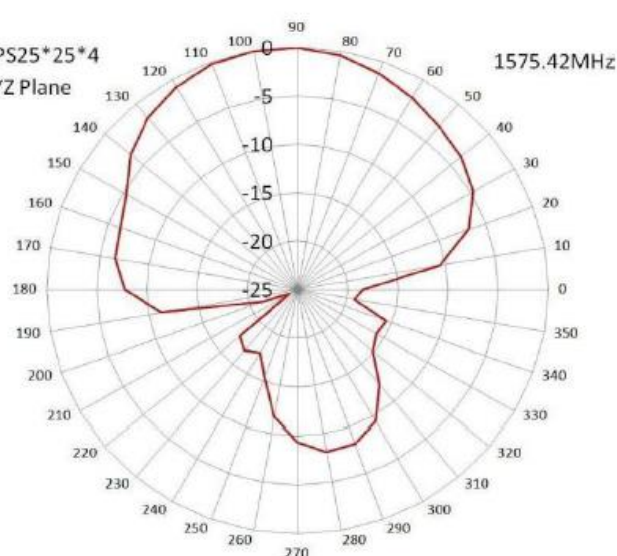
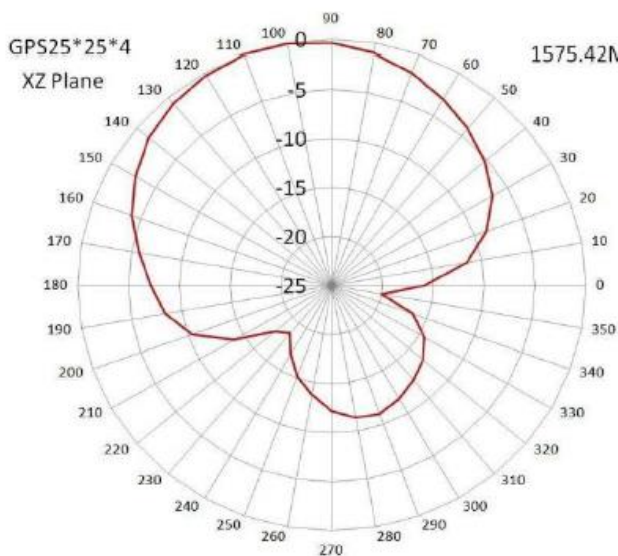
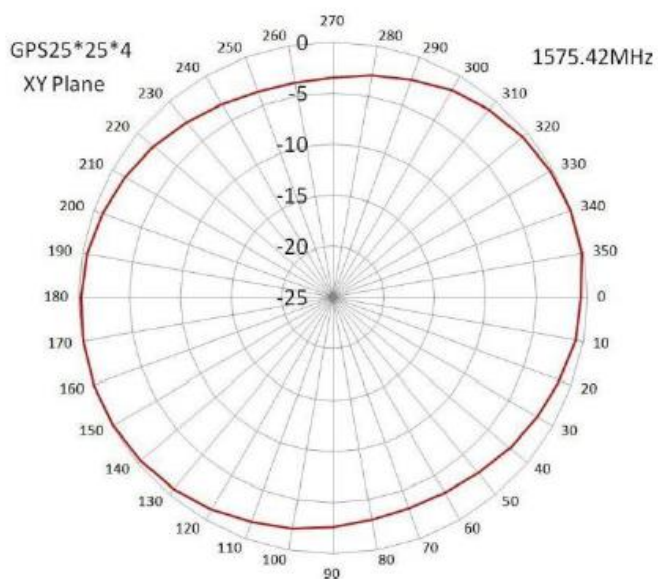

GSM ANTENNA

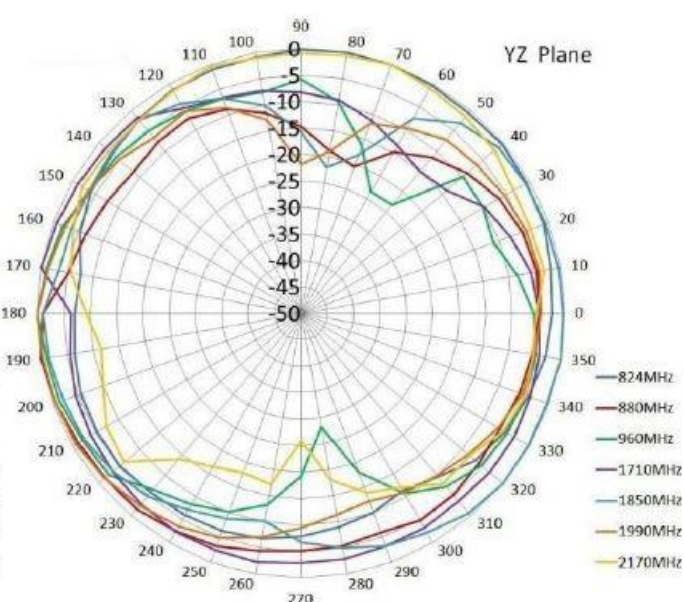
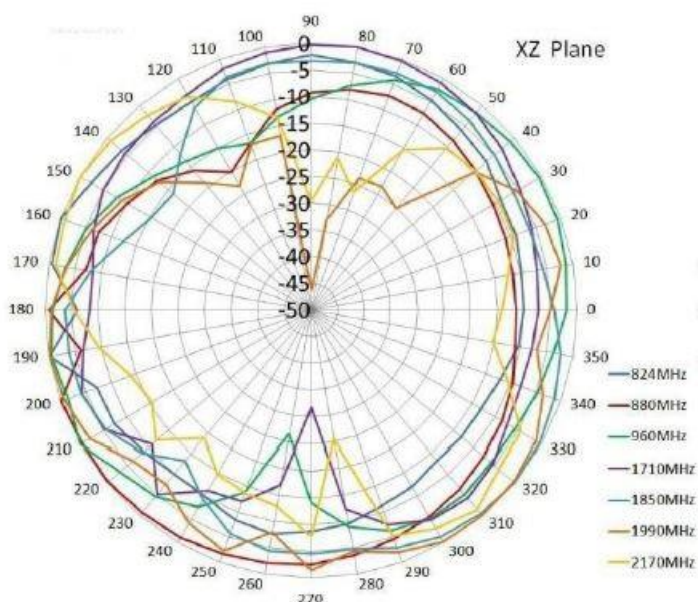
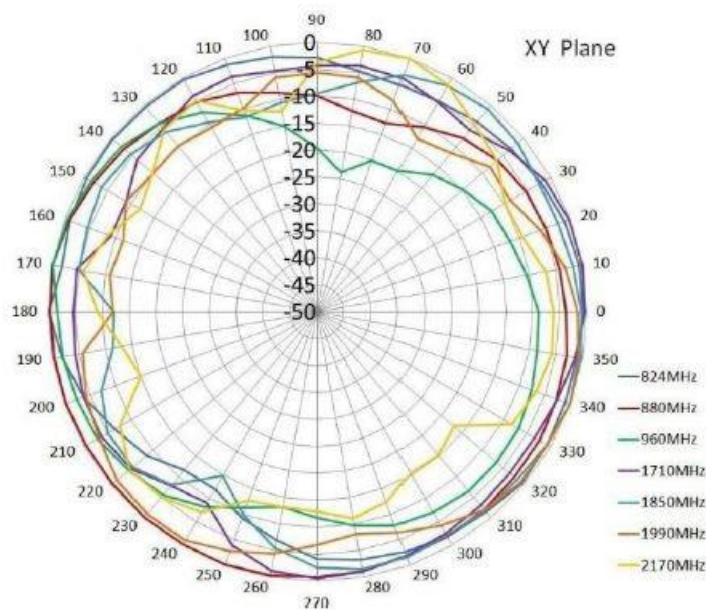

WIFI ANTENNA

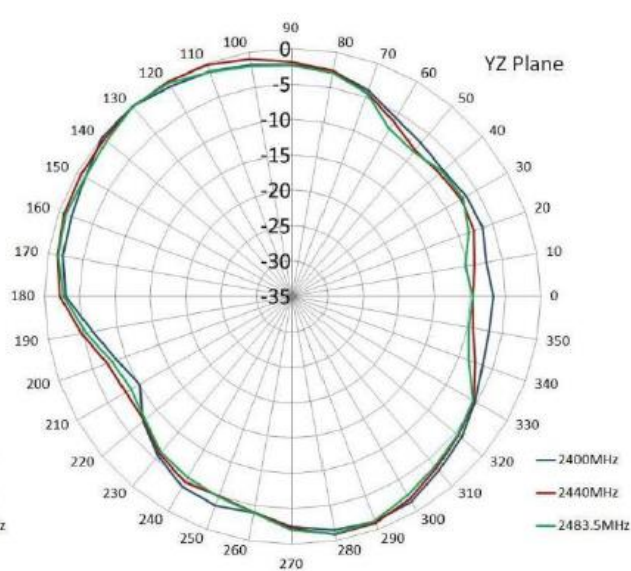
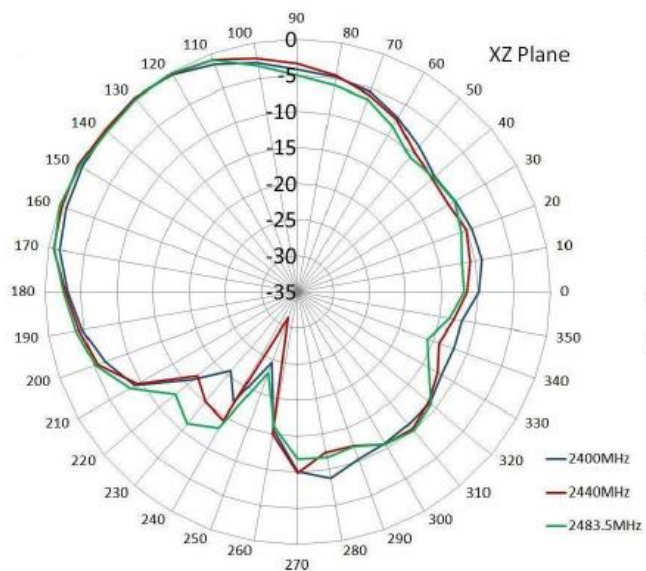
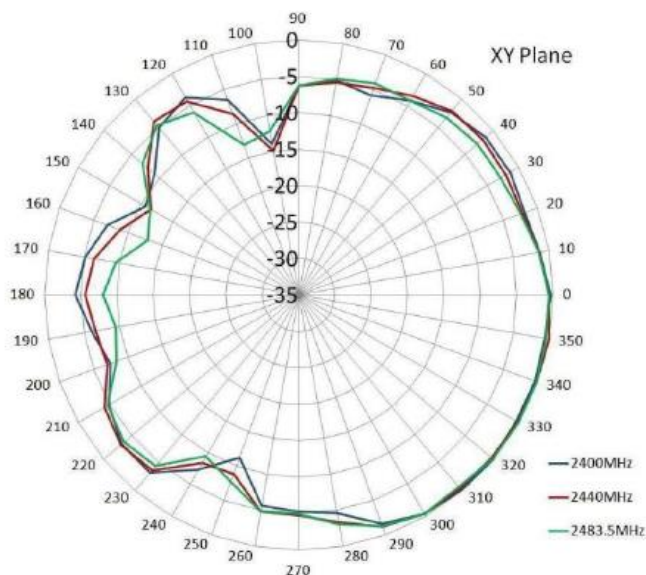

■ ENVIRONMENTAL

PARAMETER	VALUE
RoHS	Compliant
REACH SVHC	Compliant
HALOGEN-FREE	Compliant



■ APPROVAL

RALTRON	
DRAWN BY:	AR, July 13, 2022
APPROVED BY:	CP, July 13, 2022
REVISION:	A, Initial Release

Raltron Electronics / RAMI Technology USA, LLC, including its affiliates, employees, agents and other persons acting on its behalf (collectively Raltron/RAMI Tech), disclaim any and all liability for any errors or inaccuracies contained in this data sheet. While Raltron/RAMI Tech has made every reasonable effort ensure the accuracy of all product information, specifications and data contained herein, Raltron/RAMI Tech does not guarantee that the information is accurate, reliable or current. The product information is provided only for reference purposes only and is subject to change, correction or revision, at any time without notice. Raltron/RAMI Tech does not assume any liability arising out of an application or use of any product described herein and disclaims any warranties expressed or implied. The user of products in such applications shall assume all risks of such use and will agree to hold Raltron/RAMI Tech, harmless against all damages.

Copyright © 2016, Raltron Electronics / RAMI Technology USA, LLC. All rights reserved. No part of this document may be reproduced in any form without the prior written permission of Raltron Electronics / RAMI Technology USA, LLC.