



EMC filters

3-line filters
for converters and power electronics

Series/Type: **B84143C*S250/S251**

Date: October 2022

Power line filters for 3-phase systems
Rated voltage V_R : 305/530 V AC and 440/760 V AC
Rated current I_R : 160 A to 2500 A
Construction

- 3-line filters
- Metal case

Features

- Insertion loss 9 kHz and higher
- Optimized for operation under full load
- Short circuit current rating (SCCR) 100 kA
- Easy to install
- Degree of protection: IP 00¹⁾
- ENEC, UL and cUL approval

Typical applications

- Applications with attenuation requirement from 9 kHz
- Frequency converter for motor drives
- Wind farms
- Power Supplies

Terminals

- Busbars

Marking

Marking on component:

Manufacturer's logo, ordering code, rated voltage, rated current, rated temperature, climatic category, date code

Minimum data on packaging:

Manufacturer's logo, ordering code, quantity, date code



Schematic picture

1) According to IEC 60529:2015

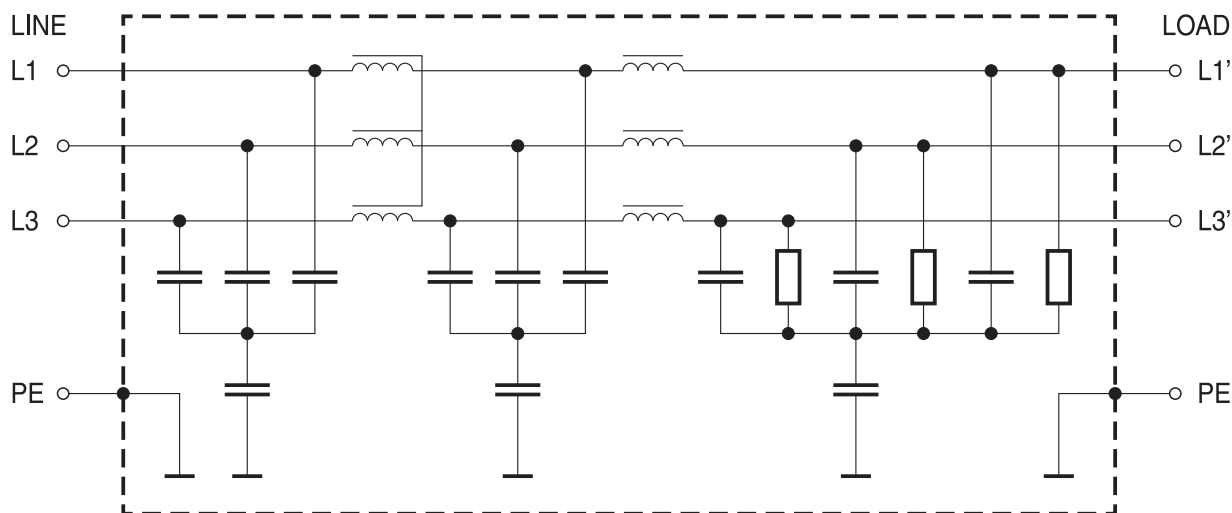
Typical circuit diagram





SSB3305-6

Technical data and measuring conditions

Rated voltage V_R [L-PE / L-L]	S250 types: 305/530 V AC (50/60 Hz) S251 types: 440/760 V AC (50/60 Hz)
Filter for IT mains supply	S250 types: 275/480 V AC (50/60 Hz) S251 types: 320/560 V AC (50/60 Hz) See also chapter "Technical information", section 8 "Energy supply networks"
Rated current I_R	Referred to 50 °C rated temperature
Test voltage V_{test} (line/line for 2 s)	S250 types: 2279 V DC S251 types: 3268 V DC
Test voltage V_{test} (line/case for 2 s)	S250 types: 2736 V DC S251 types: 3190 V DC
Overload capability (thermal)	1.5 · I_R for 3 min per hour or 2.5 · I_R for 30 s per hour
Leakage current I_{LK} (IEC 60939-1: 2010, Annex A)	At V_R and 50 Hz
Climatic category (IEC 60068-1: 2013)	25/100/21 (-25 °C/+100 °C/21 days damp heat test)
Approvals	IEC 60939-3, UL 60939-3 and CSA C22.2 No.8 approval
Short circuit current rating (SCCR) ¹⁾	100 kA

1) According to UL 508

3-line filters
B84143C*S250/S251
for converters and power electronics
Characteristics and ordering codes

I _R A	Terminal cross section mm ²	I _{LK} mA	R _{typ} mΩ	Approx. weight kg	Ordering code	Approvals ¹⁾		
								
V_R = 305/530 V AC								
160	20 × 3	46	0.13	12	B84143C0160S250	X	X	X
250	20 × 3	46	0.13	12	B84143C0250S250	X	X	X
315	25 × 5	46	0.06	15	B84143C0315S250	X	X	X
400	25 × 5	46	0.06	15	B84143C0400S250	X	X	X
630	30 × 8	46	0.035	24	B84143C0630S250	X	X	X
800	40 × 10	46	0.026	35	B84143C0800S250	X	X	X
1000	40 × 10	46	0.026	35	B84143C1000S250	X	X	X
1250	50 × 10	46	0.02	51	B84143C1250S250	X	X	X
1600	50 × 15	46	0.018	63	B84143C1600S250	X	X	X
2500	80 × 20	46	0.007	147	B84143C2500S250	X	X	X
V_R = 440/760 V AC								
160	20 × 3	46	0.13	12	B84143C0160S251	X	X	X
250	20 × 3	46	0.13	12	B84143C0250S251	X	X	X
315	25 × 5	46	0.06	15	B84143C0315S251	X	X	X
400	25 × 5	46	0.06	15	B84143C0400S251	X	X	X
630	30 × 8	46	0.035	24	B84143C0630S251	X	X	X
800	40 × 10	46	0.026	35	B84143C0800S251	X	X	X
1000	40 × 10	46	0.026	35	B84143C1000S251	X	X	X
1250	50 × 10	46	0.02	51	B84143C1250S251	X	X	X
1600	50 × 15	46	0.018	63	B84143C1600S251	X	X	X
2500	80 × 20	46	0.007	147	B84143C2500S251	X	X	X

¹⁾ Approvals

X = Approval granted

Dimensional drawings

B84143C0160S250/S251, B84143C0250S250/S251 (160 A and 250 A)

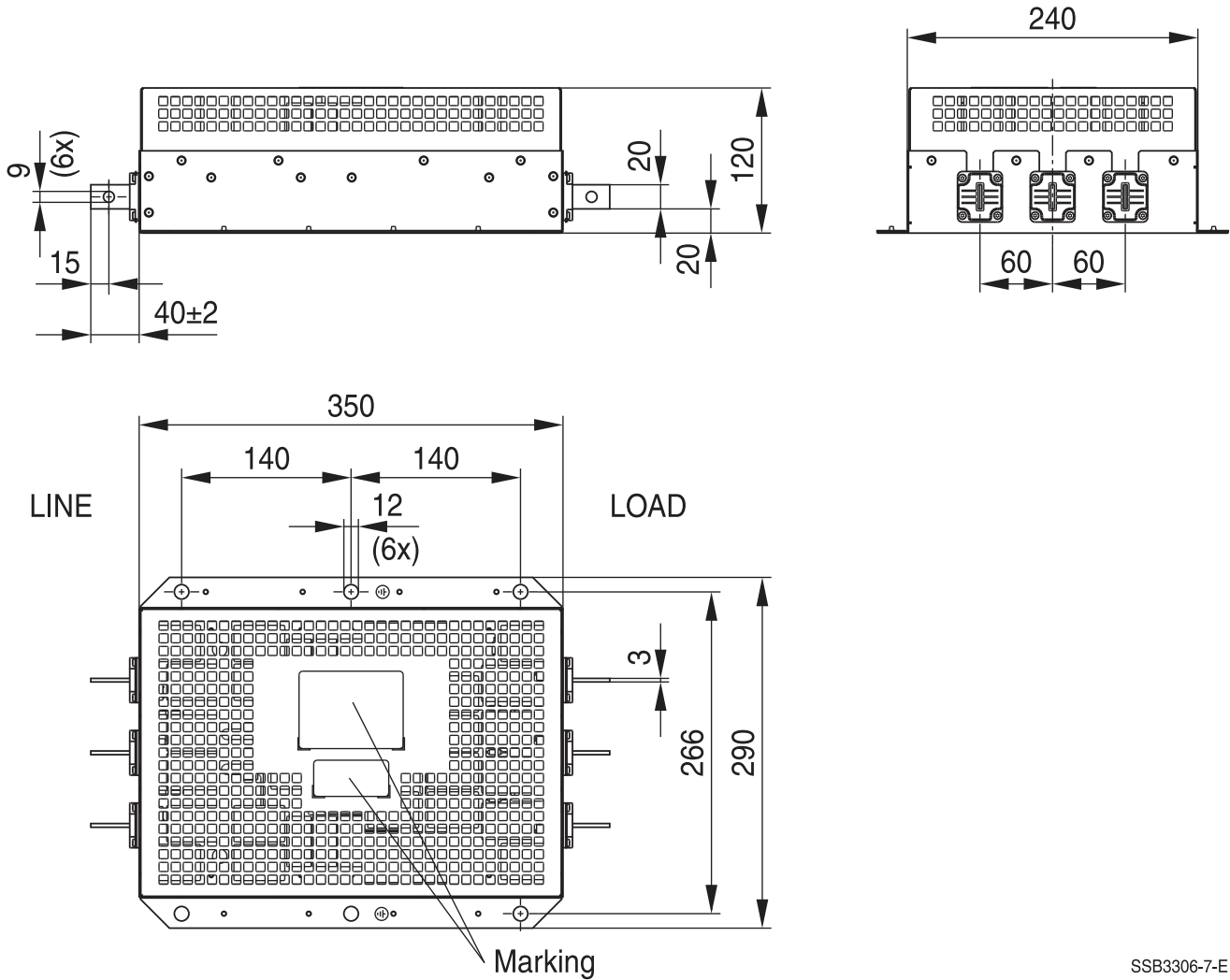

SSB3306-7-E

General tolerances according to ISO 2768-cL
 Dimensions in mm
 Busbar connection see section "Mechanical properties"

B84143C0315S250/S251, B84143C0400S250/S251 (315 A and 400 A)

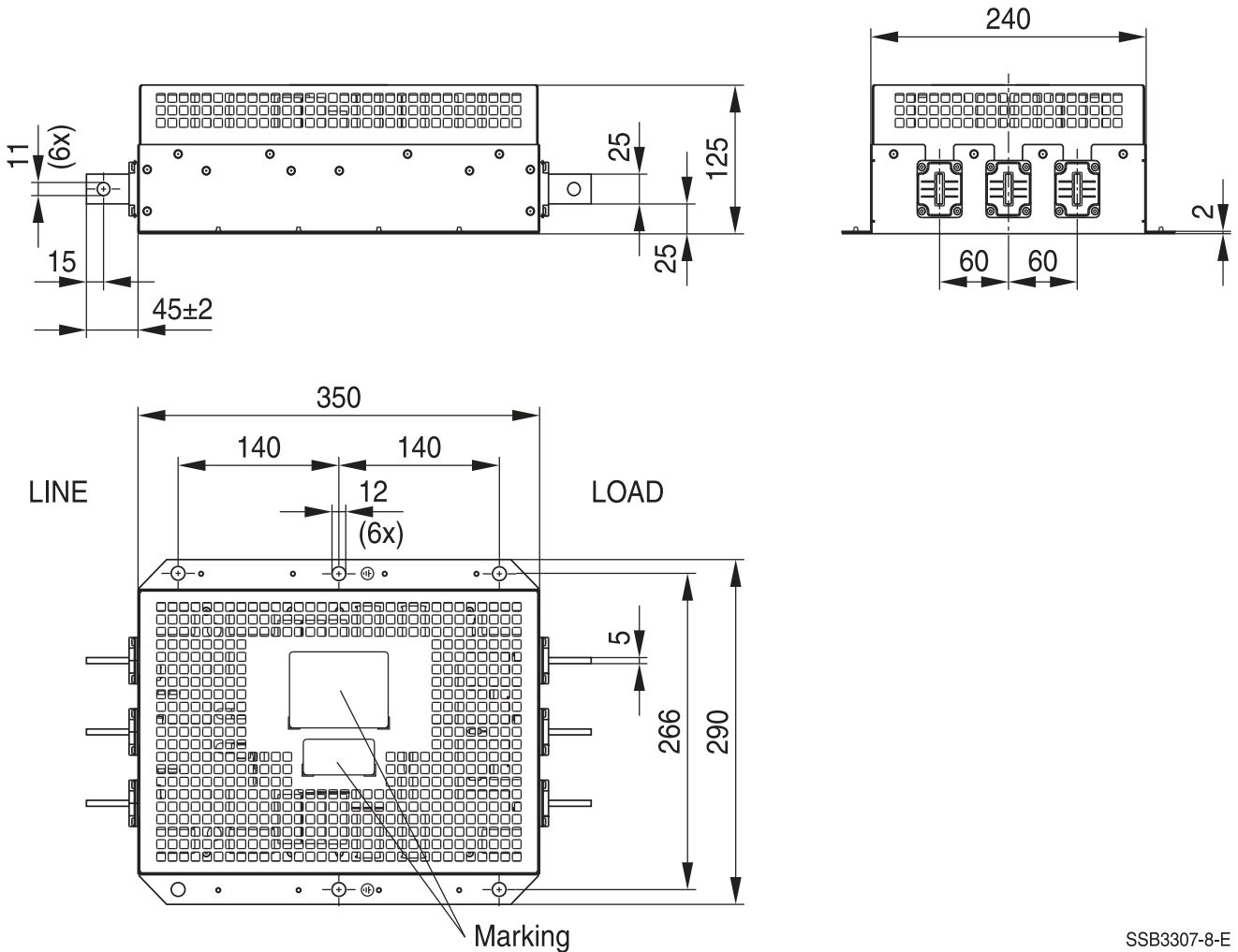

SSB3307-8-E

General tolerances according to ISO 2768-cL
 Dimensions in mm
 Busbar connection see section "Mechanical properties"

B84143C0630S250/S251 (630 A)

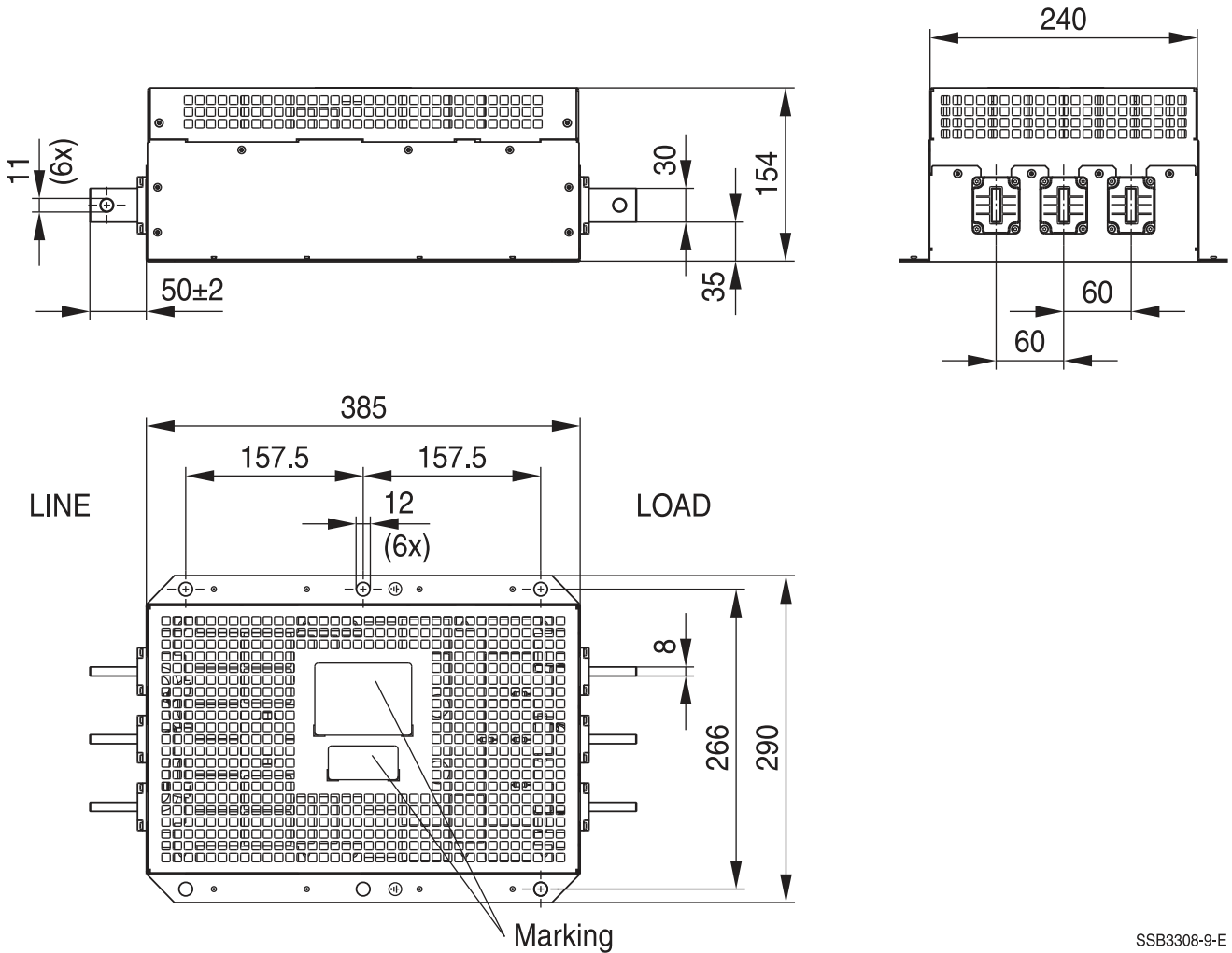

SSB3308-9-E

General tolerances according to ISO 2768-cL
 Dimensions in mm
 Busbar connection see section "Mechanical properties"

3-line filters

B84143C*S250/S251

for converters and power electronics

B84143C0800S250/S251, B84143C1000S250/S251 (800 A and 1000 A)

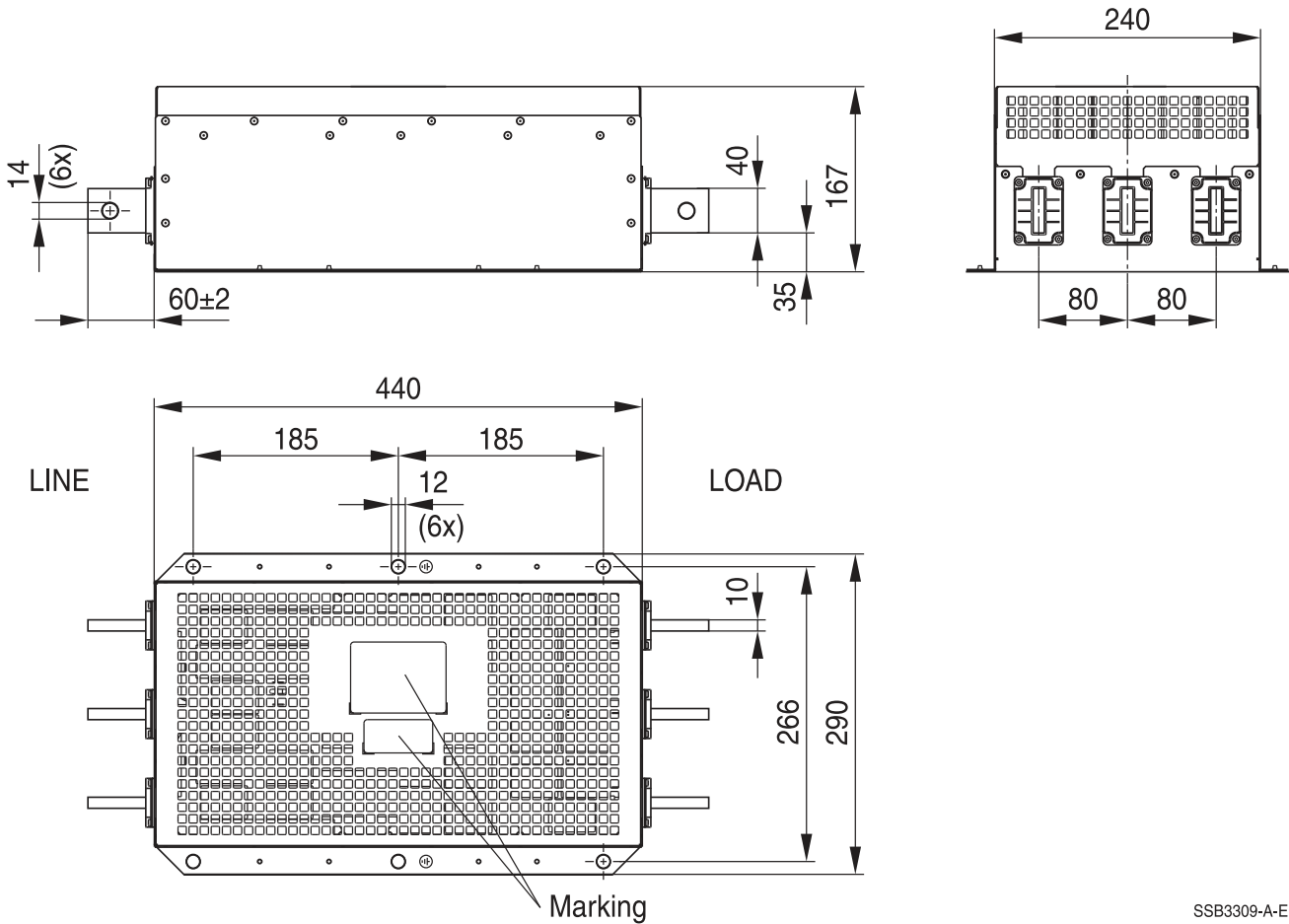

SSB3309-A-E

General tolerances according to ISO 2768-cL

Dimensions in mm

Busbar connection see section "Mechanical properties"

3-line filters

B84143C*S250/S251

for converters and power electronics

B84143C1250S250/S251 (1250 A)

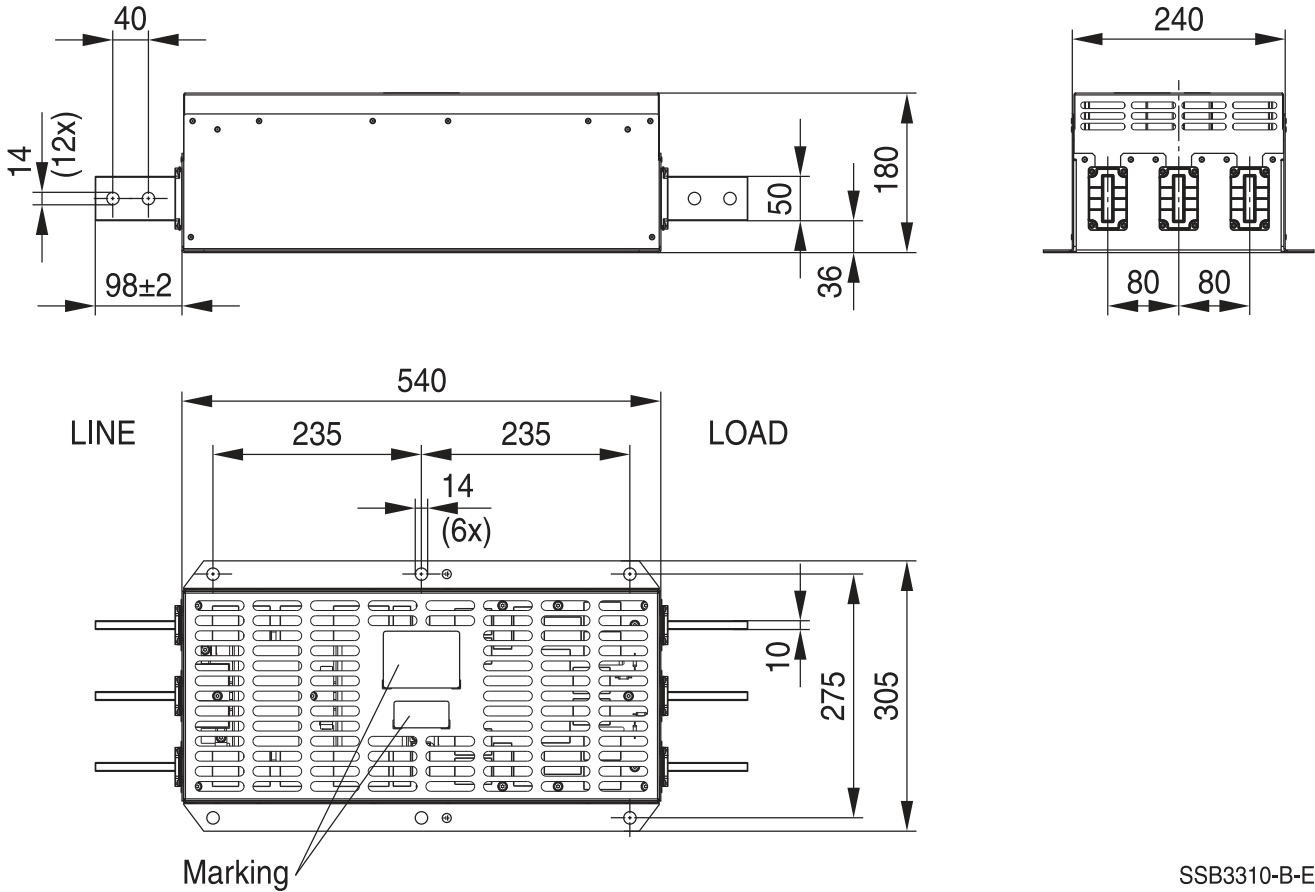

SSB3310-B-E

General tolerances according to ISO 2768-cL
 Dimensions in mm
 Busbar connection see section "Mechanical properties"

B84143C1600S250/S251 (1600 A)

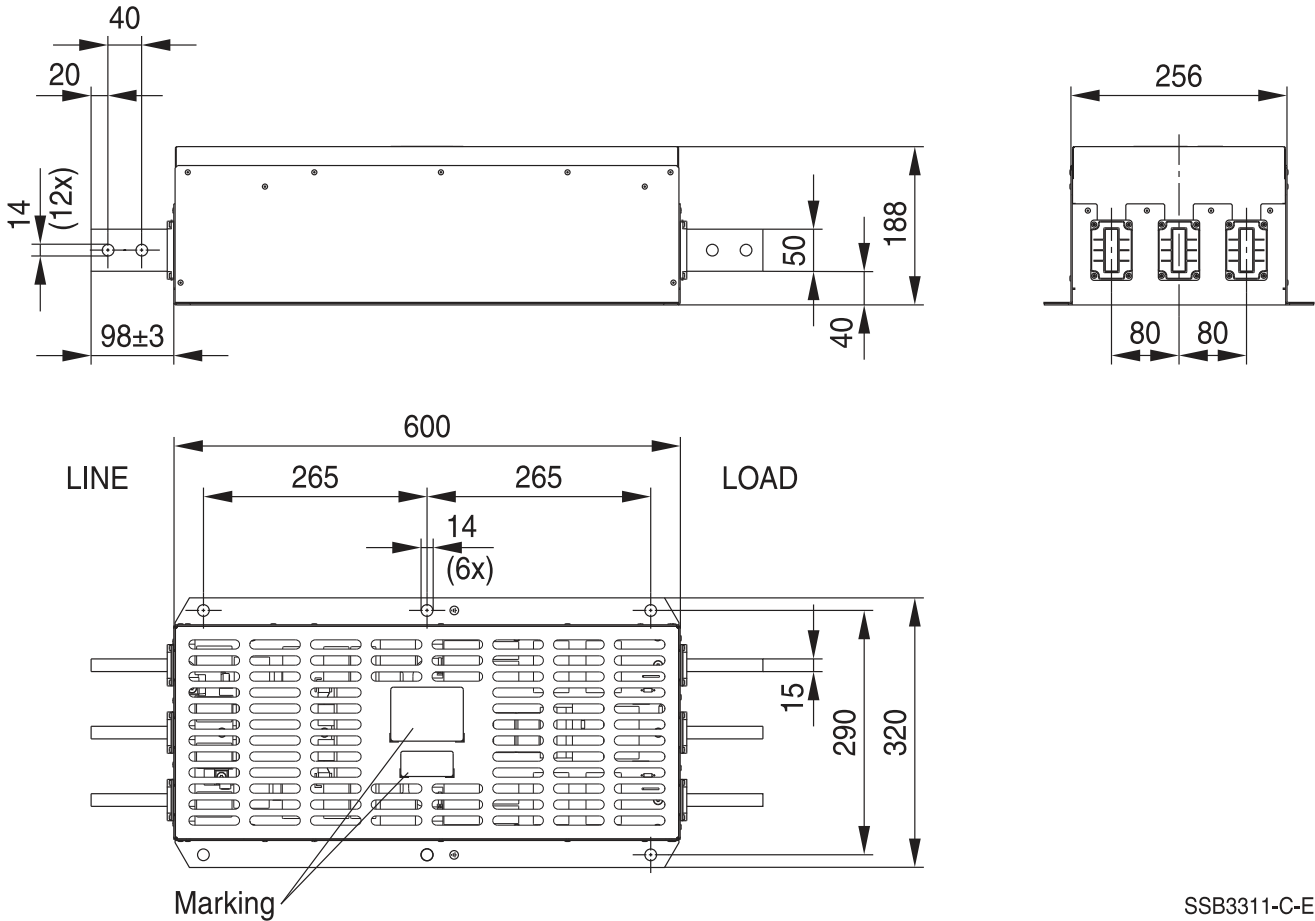

SSB3311-C-E

General tolerances according to ISO 2768-cL
 Dimensions in mm
 Busbar connection see section "Mechanical properties"

B84143C2500S250/S251 (2500 A)

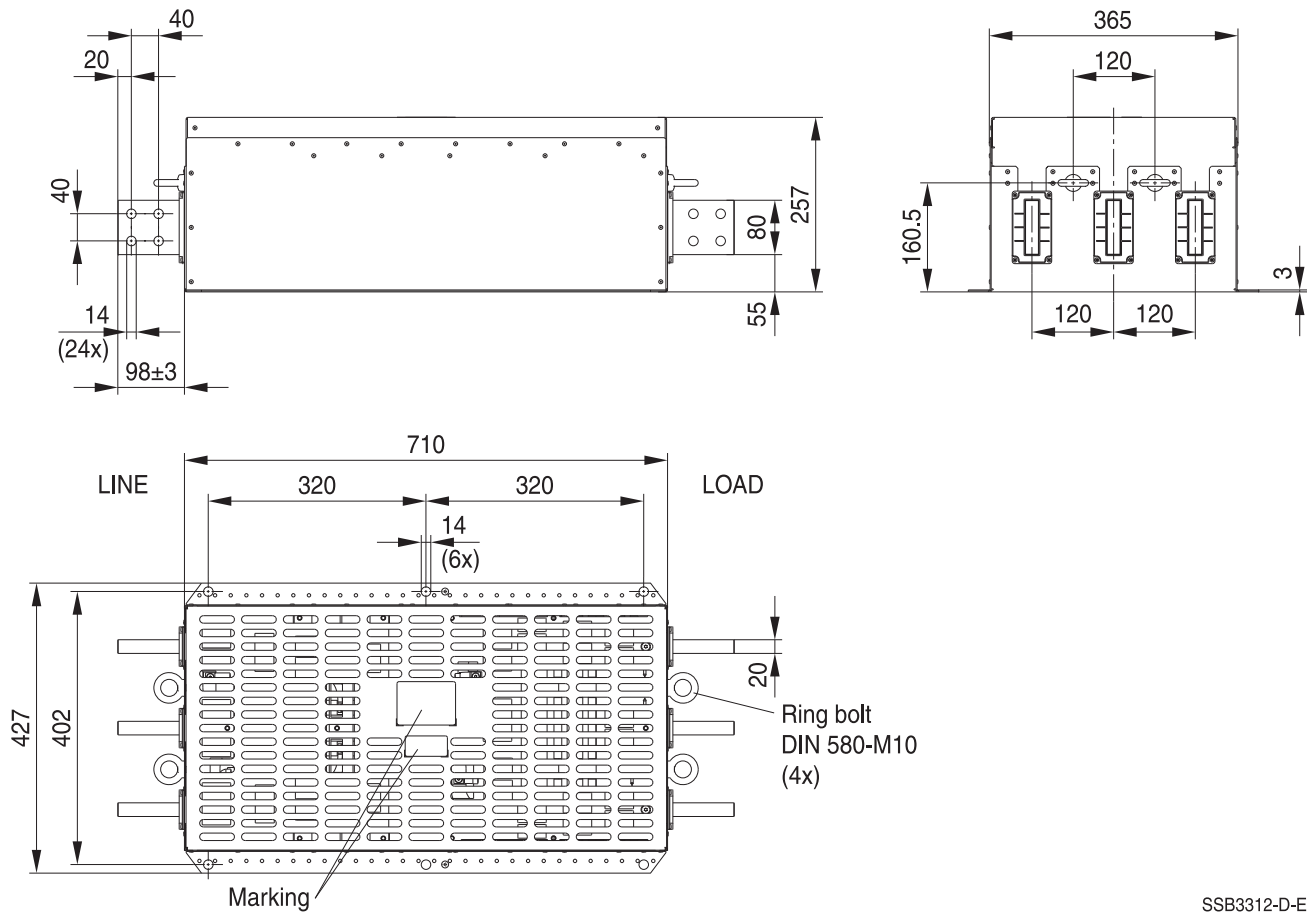

SSB3312-D-E

General tolerances according to ISO 2768-cL
Dimensions in mm

Busbar connection see section "Mechanical properties"

Insertion loss (typical values at $Z = 50 \Omega$)

- unsymmetrical, adjacent branches terminated
- - - - - common mode, all branches in parallel (asymmetrical)
- - - - - differential mode (symmetrical)

Filters for 160 A and 250 A

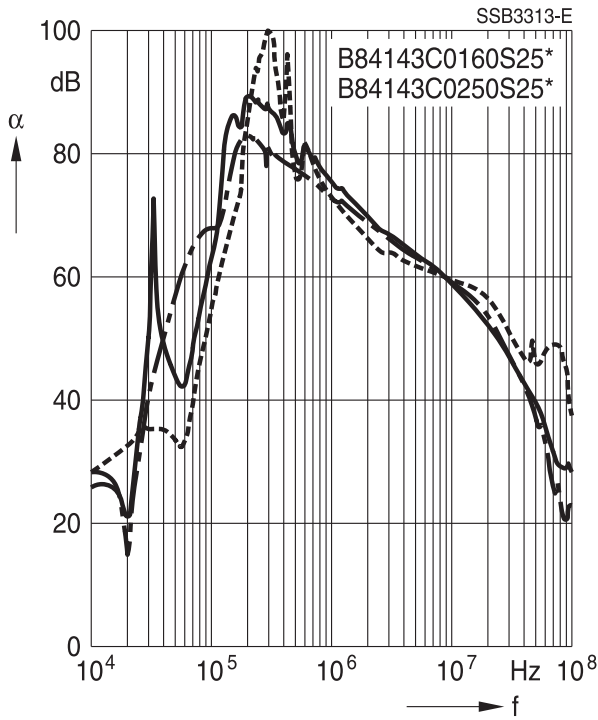

Filters for 315 A and 400 A

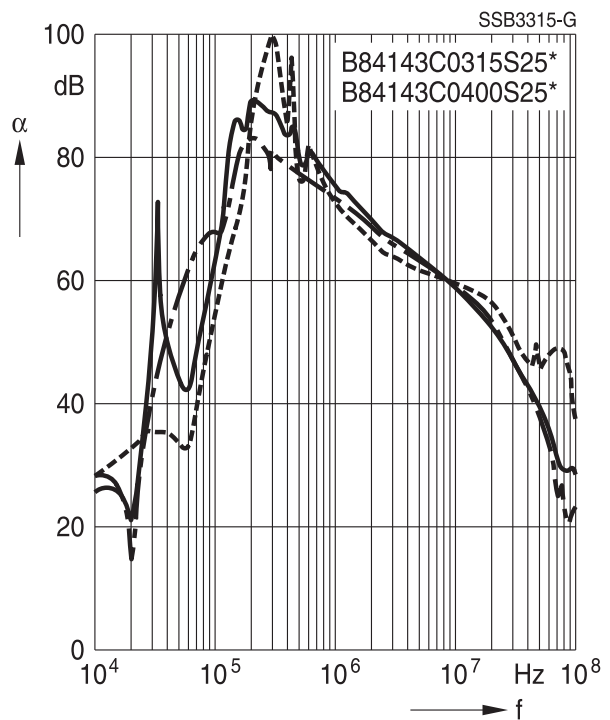

Filters for 630 A

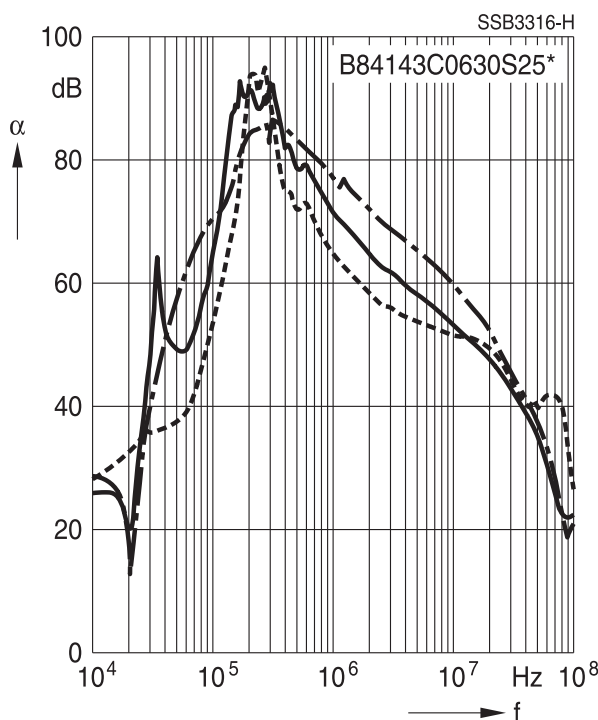

Filters for 800 A and 1000 A

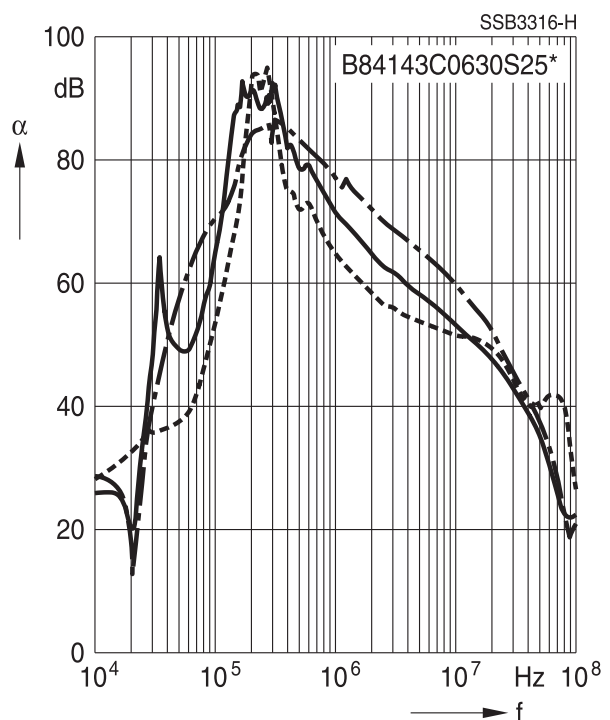

3-line filters

B84143C*S250/S251

for converters and power electronics

- unsymmetrical, adjacent branches terminated
- - - - - common mode, all branches in parallel (asymmetrical)
- - - - - differential mode (symmetrical)

Filters for 1250A

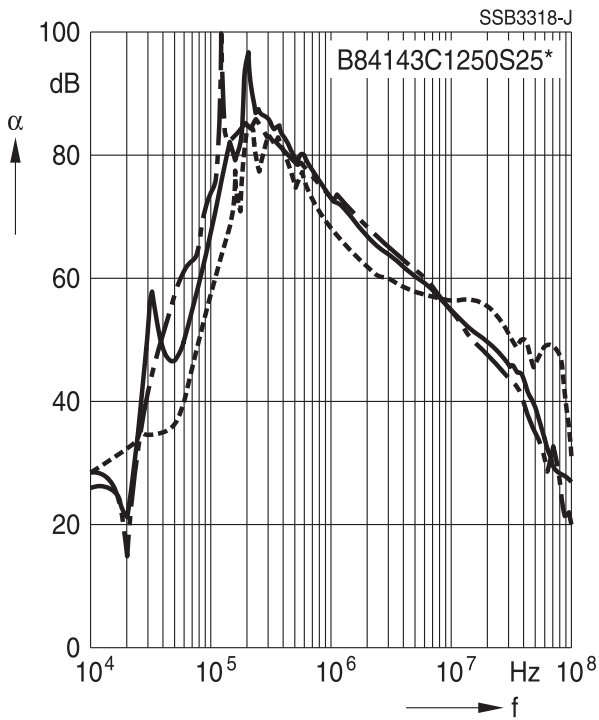

Filters for 1600 A

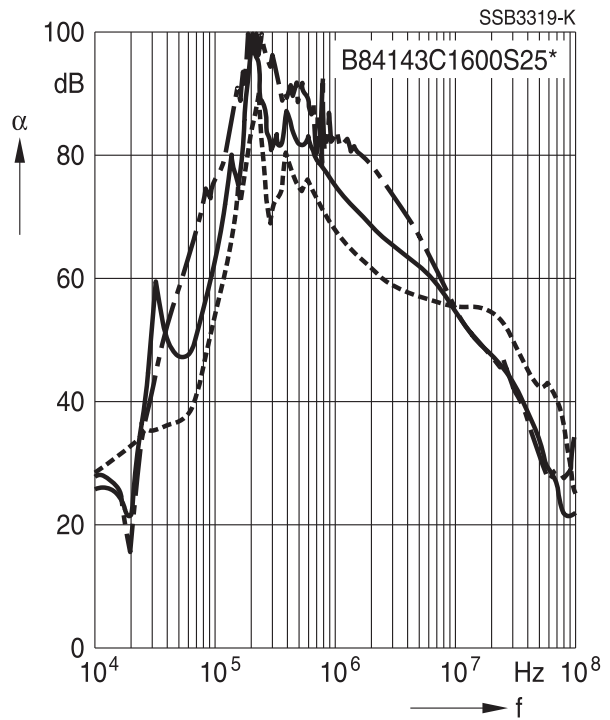

Filters for 2500 A

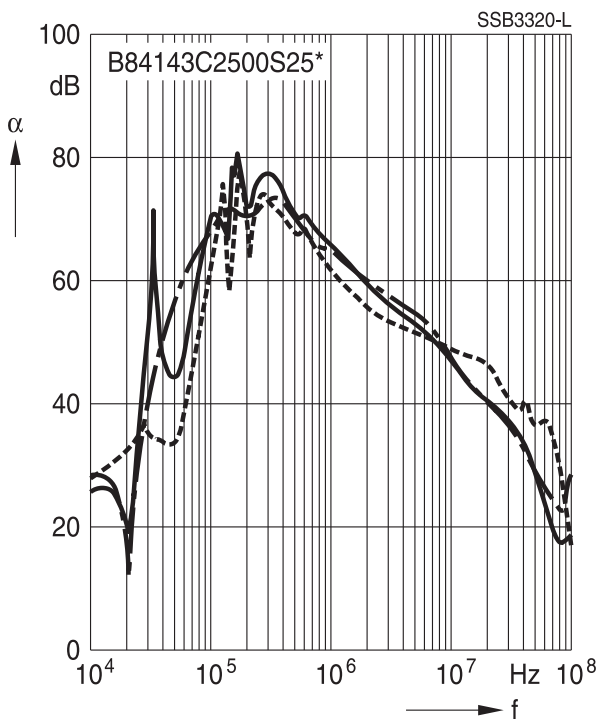

Cautions and warnings

- Please note further advice in our website www.tdk-electronics.tdk.com/pemc_filters_gti
- It shall be ensured that only qualified persons (electricity specialists) are engaged on work such as planning, assembly, installation, operation, repair and maintenance. They must be provided with the corresponding documentation.
- Danger of electric shock: The products contain components that store an electric charge. Dangerous voltages can continue to exist at the product terminals for longer than five minutes even after the power has been switched off.
- The protective earth connections shall be the first to be made when the product is installed and secured against loosening by defined tightening torque. Remove them at last, when uninstalling. Depending on the magnitude of the leakage currents, the particular specifications for making the protective-earth connection must be observed.
- Impermissible overloading of the product, such as with circuits able to cause resonances, impermissible voltages at higher frequencies etc. can lead to bodily injury and death as well as cause substantial material damages (e.g. destruction of the product housing).
- The products must be protected in the application against impermissible exceeding of the rated currents by overcurrent protective devices.
- For leakage currents >10 mA, a fixed connection of the protective earth conductor to the public power grid is required. This means that connection via plug connectors is not permitted. The protective conductor must have a minimum cross-section of 10 mm² Cu or 16 mm² Al over its entire length. Alternatively, two separate protective conductors with the minimum cross-section specified in each case can also be connected.
- For leakage currents 3.5 mA $< I_{LK}^a) \leq 10$ mA, the following solutions are possible:
 - Stationary device with fixed connection
 - Stationary device with type B plug-in connection (industrial plug-in connection according to IEC 60309) and cross-section ≥ 2.5 mm²
 - Stationary device with type A plug-in connection (non-industrial plug-in device) and additional second protective earth connection
 - Movable equipment with type A plug-in connection and additional second protective earth connection in premises with restricted access
 - The products must be protected in the application against impermissible exceeding of the specification parameter.
- The converter output frequency must be within the specified range to avoid resonances and uncontrolled warming of the output chokes and output filters.
- The components can become very hot during operation, there is the risk of burns if touched. The product can remain hot for some time after the power is switched off!
- The products are only to be attached to the fixings or mounting holes provided for this purpose in accordance with the data sheet. It is not permitted for the product specified in the data sheet to assume a mechanical function in the final application, in particular any type of tension or pressure on the product must be prevented.

a) I_{LK} = Leakage current

The table below summarizes the safety instructions that must be observed without fail. A detailed description can be found in the relevant documents *General information* and *Technical information*.

Selecting a product	When selecting a product, it is mandatory to observe the rated data of the equipment (such as its rated input current, rated voltage, harmonic content etc.) as well as the derating instructions (see section 9 in document "Technical information").
Rated voltage	When power distribution systems deviating from the symmetric TN-S system it is to check the suitability of the products and the allowed voltages including the fault cases.
Protection from residual voltages Discharge resistors	Active parts must be discharged within 5 s to a voltage of less than 60 V (or 50 μ C). If this limit cannot be observed due to the operating mode, the hazardous point must be permanently marked in a clearly visible way. Products which are not permanently connected (e.g. when the test voltage is applied to the product at the incoming goods inspection) must be discharged after the voltage has been switched off.
Installing and removing of products Installation	When installing and removing our products, a voltage-free state must be set up and secured with observance of the five safety rules described in EN 50110-1.
Use in IT systems	The special features of the IT system ("first fault case" and other fault cases) shall be observed.
Safety notes on leakage currents	The product leakage currents specified in the datasheets are intended for user information only. The maximum leakage current of the entire electrical equipment or appliance has to be limited for safety reasons. Please obtain the applicable leakage current limits for your application from the relevant regulations, provisions and standards.
Voltage derating Hazards caused by overloading the products	If the permissible limits for the higher-frequency voltages at the product are exceeded, the product may be damaged or destroyed.
Current derating at elevated ambient temperatures	Non-observance of the current derating may lead to overheating and consequently represents a fire hazard.
Protective earth connection at operating currents > 250 A	For operating currents greater than 250 A, we recommend the PE connection to be set up between the feed (product: line) and output (product: load) not via the PE terminal bolt in the product housing.
Mounting position	Note the mounting position of the products! It must always be ensured that natural convection is not impaired.
Long motor cables	Long motor cables cause parasitic currents in the installation. The cable lengths indicated for the output chokes and output filters serve for orientation. The user must check the technical parameters and especially the choke temperatures for the respective application.

Symbols and terms

Symbol	English	German
α	Insertion loss	Einfügungsdämpfung
C_R	Rated capacitance	Bemessungskapazität
C_X	Capacitance X capacitor	Kapazität X-Kondensator
C_Y	Capacitance Y capacitor	Kapazität Y-Kondensator
ΔV	Voltage drop (input to output)	Spannungsabfall (Eingang zu Ausgang)
dv/dt	Rate of voltage rise	Spannungsanstiegsgeschwindigkeit
f	Frequency	Frequenz
f_M	Converter output frequency	Motorfrequenz
f_P	Pulse frequency	Pulsfrequenz
f_R	Rated frequency	Bemessungsfrequenz
f_{res}	Resonant frequency	Resonanzfrequenz
I_C	Current through capacitor	Strom durch Kondensator
I_{LK}	Filter leakage current	Filter-Ableitstrom
I_{max}	Maximum current	Maximalstrom
I_N	Nominal current	Nennstrom
I_{op}	Operating current (design current)	Betriebsstrom
I_{pk}	Rated peak withstand current	Bemessungsstoßstromfestigkeit
I_q	Capacitive reactive current	Kapazitiver Blindstrom
I_R	Rated current	Bemessungsstrom
I_S	Interference current	Störstrom
L	Inductance	Induktivität
L_R	Rated inductance	Bemessungsinduktivität
L_{stray}	Stray inductance	Streuinduktivität
P_L	Power loss	Verlustleistung
R	Resistance	Widerstand
R_{is}	Insulation resistance	Isolationswiderstand
R_{typ}	DC resistance, typical value	Gleichstromwiderstand typisch
T_A	Ambient temperature	Umgebungstemperatur
T_{max}	Upper category temperature	Obere Kategorietemperatur
T_{min}	Lower category temperature	Untere Kategorietemperatur
T_R	Rated temperature	Bemessungstemperatur
u_k	Referred voltage drop in %	Bezogener Spannungsabfall in %
V_{eff}	RMS voltage	Effektivspannung
V_K	Voltage drop	Spannungsabfall
V_{LE}	Voltage line to earth; voltage line to ground	Spannung Phase zu Erdpotential
V_N	Nominal voltage	Nennspannung
V_R	Rated voltage	Bemessungsspannung
V_{peak}	Peak voltage	Spitzenspannung
V_{test}	Test voltage	Prüfspannung

Symbol	English	German
V_X	Voltage over X capacitor	Spannung über X-Kondensator
V_Y	Voltage over Y capacitor	Spannung über Y-Kondensator
X_L	Inductive reactance	Induktiver Blindwiderstand
Z	Impedance	Scheinwiderstand
$ Z $	Impedance, absolute value	Scheinwiderstand (Betragswert)

Important notes

The following applies to all products named in this publication:

1. Some parts of this publication contain **statements about the suitability of our products for certain areas of application**. These statements are based on our knowledge of typical requirements that are often placed on our products in the areas of application concerned. We nevertheless expressly point out **that such statements cannot be regarded as binding statements about the suitability of our products for a particular customer application**. As a rule, we are either unfamiliar with individual customer applications or less familiar with them than the customers themselves. For these reasons, it is always ultimately incumbent on the customer to check and decide whether a product with the properties described in the product specification is suitable for use in a particular customer application.
2. We also point out that **in individual cases, a malfunction of electronic components or failure before the end of their usual service life cannot be completely ruled out in the current state of the art, even if they are operated as specified**. In customer applications requiring a very high level of operational safety and especially in customer applications in which the malfunction or failure of an electronic component could endanger human life or health (e.g. in accident prevention or life-saving systems), it must therefore be ensured by means of suitable design of the customer application or other action taken by the customer (e.g. installation of protective circuitry or redundancy) that no injury or damage is sustained by third parties in the event of malfunction or failure of an electronic component.
3. **The warnings, cautions and product-specific notes must be observed.**
4. In order to satisfy certain technical requirements, **some of the products described in this publication may contain substances subject to restrictions in certain jurisdictions (e.g. because they are classed as hazardous)**. Useful information on this will be found in our Material Data Sheets on the Internet (www.tdk-electronics.tdk.com/material). Should you have any more detailed questions, please contact our sales offices.
5. We constantly strive to improve our products. Consequently, **the products described in this publication may change from time to time**. The same is true of the corresponding product specifications. Please check therefore to what extent product descriptions and specifications contained in this publication are still applicable before or when you place an order. We also **reserve the right to discontinue production and delivery of products**. Consequently, we cannot guarantee that all products named in this publication will always be available. The aforementioned does not apply in the case of individual agreements deviating from the foregoing for customer-specific products.
6. Unless otherwise agreed in individual contracts, **all orders are subject to our General Terms and Conditions of Supply**.

Important notes

7. **Our manufacturing sites serving the automotive business apply the IATF 16949 standard.** The IATF certifications confirm our compliance with requirements regarding the quality management system in the automotive industry. Referring to customer requirements and customer specific requirements (“CSR”) TDK always has and will continue to have the policy of respecting individual agreements. Even if IATF 16949 may appear to support the acceptance of unilateral requirements, we hereby like to emphasize that **only requirements mutually agreed upon can and will be implemented in our Quality Management System.** For clarification purposes we like to point out that obligations from IATF 16949 shall only become legally binding if individually agreed upon.
8. The trade names EPCOS, CarXield, CeraCharge, CeraDiode, CeraLink, CeraPad, CeraPlas, CSMP, CTVS, DeltaCap, DigiSiMic, ExoCore, FilterCap, FormFit, InsuGate, LeaXield, MiniBlue, MiniCell, MKD, MKK, ModCap, MotorCap, PCC, PhaseCap, PhaseCube, PhaseMod, PhiCap, PowerHap, PQSine, PQvar, SIFERRIT, SIFI, SIKOREL, SilverCap, SIMDAD, SiMic, SIMID, SineFormer, SIOV, ThermoFuse, WindCap, XieldCap are **trademarks registered or pending** in Europe and in other countries. Further information will be found on the Internet at www.tdk-electronics.tdk.com/trademarks.

Release 2022-07