

LQFP-128 to PGA-128 SMT Adapter (0.5 mm pitch, 20 x 20 mm body)

REF.	DIMENSIONS					
	mm			inches		
	MIN.	TYP.	MAX.	MIN.	TYP.	MAX.
A		19.60				
A2		19.60				
B		2.00				
C		0.30				
D		0.20				
E		0.50				

Top View (SMT Footprint)

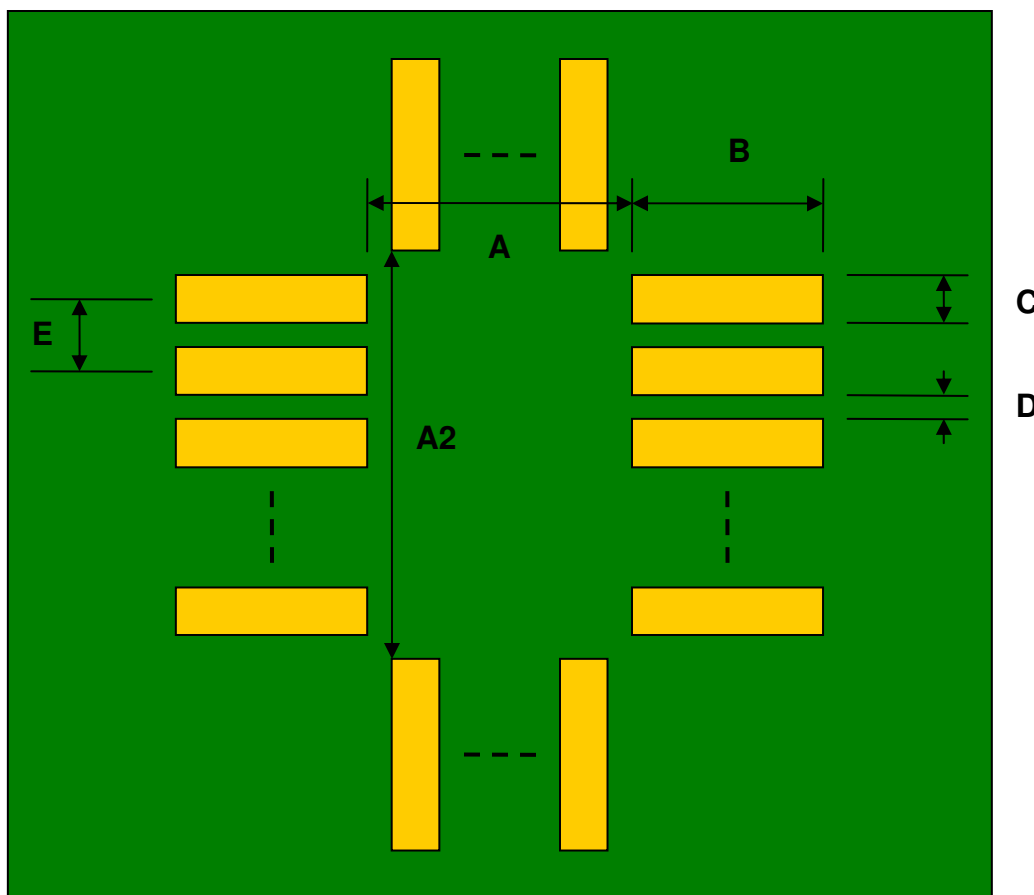

(Representative drawing only - not to scale)