



Is Now Part of



ON Semiconductor®

To learn more about ON Semiconductor, please visit our website at
www.onsemi.com

Please note: As part of the Fairchild Semiconductor integration, some of the Fairchild orderable part numbers will need to change in order to meet ON Semiconductor's system requirements. Since the ON Semiconductor product management systems do not have the ability to manage part nomenclature that utilizes an underscore (_), the underscore (_) in the Fairchild part numbers will be changed to a dash (-). This document may contain device numbers with an underscore (_). Please check the ON Semiconductor website to verify the updated device numbers. The most current and up-to-date ordering information can be found at www.onsemi.com. Please email any questions regarding the system integration to Fairchild_questions@onsemi.com.

ON Semiconductor and the ON Semiconductor logo are trademarks of Semiconductor Components Industries, LLC dba ON Semiconductor or its subsidiaries in the United States and/or other countries. ON Semiconductor owns the rights to a number of patents, trademarks, copyrights, trade secrets, and other intellectual property. A listing of ON Semiconductor's product/patent coverage may be accessed at www.onsemi.com/site/pdf/Patent-Marking.pdf. ON Semiconductor reserves the right to make changes without further notice to any products herein. ON Semiconductor makes no warranty, representation or guarantee regarding the suitability of its products for any particular purpose, nor does ON Semiconductor assume any liability arising out of the application or use of any product or circuit, and specifically disclaims any and all liability, including without limitation special, consequential or incidental damages. Buyer is responsible for its products and applications using ON Semiconductor products, including compliance with all laws, regulations and safety requirements or standards, regardless of any support or applications information provided by ON Semiconductor. "Typical" parameters which may be provided in ON Semiconductor data sheets and/or specifications can and do vary in different applications and actual performance may vary over time. All operating parameters, including "Typicals" must be validated for each customer application by customer's technical experts. ON Semiconductor does not convey any license under its patent rights nor the rights of others. ON Semiconductor products are not designed, intended, or authorized for use as a critical component in life support systems or any FDA Class 3 medical devices or medical devices with a same or similar classification in a foreign jurisdiction or any devices intended for implantation in the human body. Should Buyer purchase or use ON Semiconductor products for any such unintended or unauthorized application, Buyer shall indemnify and hold ON Semiconductor and its officers, employees, subsidiaries, affiliates, and distributors harmless against all claims, costs, damages, and expenses, and reasonable attorney fees arising out of, directly or indirectly, any claim of personal injury or death associated with such unintended or unauthorized use, even if such claim alleges that ON Semiconductor was negligent regarding the design or manufacture of the part. ON Semiconductor is an Equal Opportunity/Affirmative Action Employer. This literature is subject to all applicable copyright laws and is not for resale in any manner.

FDP7N50

N-Channel UniFET™ MOSFET

500 V, 7 A, 900 mΩ

Features

- $R_{DS(on)} = 900\text{ m}\Omega$ (Max.) @ $V_{GS} = 10\text{ V}$, $I_D = 3.5\text{ A}$
- Low Gate Charge (Typ. 12.8 nC)
- Low C_{rss} (Typ. 9 pF)
- 100% Avalanche Tested

Applications

- ALCD/LED TV
- Lighting
- Uninterruptible Power Supply
- AC-DC Power Supply applications

Description

UniFET™ MOSFET is Fairchild Semiconductor®'s high voltage MOSFET family based on planar stripe and DMOS technology. This MOSFET is tailored to reduce on-state resistance, and to provide better switching performance and higher avalanche energy strength. This device family is suitable for switching power converter applications such as power factor correction (PFC), flat panel display (FPD) TV power, ATX and electronic lamp ballasts.

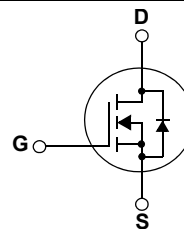
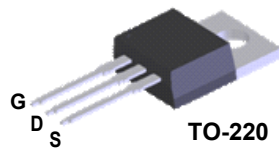

Absolute Maximum Ratings

| Symbol | Parameter | | FDP7N50 | Unit |
|----------------|--|--|-------------|---------------------|
| V_{DSS} | Drain-Source Voltage | | 500 | V |
| I_D | Drain Current | - Continuous ($T_C = 25^\circ\text{C}$) | 7 | A |
| | | - Continuous ($T_C = 100^\circ\text{C}$) | 4.2 | A |
| I_{DM} | Drain Current | - Pulsed (Note 1) | 28 | A |
| V_{GSS} | Gate-Source voltage | | ± 30 | V |
| E_{AS} | Single Pulsed Avalanche Energy | (Note 2) | 270 | mJ |
| I_{AR} | Avalanche Current | (Note 1) | 7 | A |
| E_{AR} | Repetitive Avalanche Energy | (Note 1) | 8.9 | mJ |
| dv/dt | Peak Diode Recovery dv/dt (Note 3) | | 4.5 | V/ns |
| P_D | Power Dissipation | ($T_C = 25^\circ\text{C}$) | 89 | W |
| | | - Derate above 25°C | 0.71 | W/ $^\circ\text{C}$ |
| T_J, T_{STG} | Operating and Storage Temperature Range | | -55 to +150 | $^\circ\text{C}$ |
| T_L | Maximum Lead Temperature for Soldering Purpose, 1/8" from Case for 5 Seconds | | 300 | $^\circ\text{C}$ |

Thermal Characteristics

| Symbol | Parameter | FDP7N50 | Unit |
|-----------------|---|---------|---------------------------|
| $R_{\theta JC}$ | Thermal Resistance, Junction-to-Case, Max. | 1.4 | $^\circ\text{C}/\text{W}$ |
| $R_{\theta CS}$ | Thermal Resistance, Case-to-Sink, Typ. | 0.5 | |
| $R_{\theta JA}$ | Thermal Resistance, Junction-to-Ambient, Max. | 62.5 | |

Package Marking and Ordering Information

| Device Marking | Device | Package | Reel Size | Tape Width | Quantity |
|----------------|---------|---------|-----------|------------|----------|
| FDP7N50 | FDP7N50 | TO-220 | -- | -- | 50 |

Electrical Characteristics T_C = 25°C unless otherwise noted

| Symbol | Parameter | Conditions | Min. | Typ. | Max | Unit |
|---|---|--|----------|------|---------|----------|
| Off Characteristics | | | | | | |
| BV _{DSS} | Drain-Source Breakdown Voltage | V _{GS} = 0V, I _D = 250μA | 500 | -- | -- | V |
| ΔBV _{DSS} / ΔT _J | Breakdown Voltage Temperature Coefficient | I _D = 250μA, Referenced to 25°C | -- | 0.5 | -- | V/°C |
| I _{DSS} | Zero Gate Voltage Drain Current | V _{DS} = 500V, V _{GS} = 0V V _{DS} = 400V, T _C = 125°C | -- | -- | 1 10 | μA μA |
| I _{GSSF} | Gate-Body Leakage Current, Forward | V _{GS} = 30V, V _{DS} = 0V | -- | -- | 100 | nA |
| I _{GSSR} | Gate-Body Leakage Current, Reverse | V _{GS} = -30V, V _{DS} = 0V | -- | -- | -100 | nA |
| On Characteristics | | | | | | |
| V _{GS(th)} | Gate Threshold Voltage | V _{DS} = V _{GS} , I _D = 250μA | 3.0 | -- | 5.0 | V |
| R _{DS(on)} | Static Drain-Source On-Resistance | V _{GS} = 10V, I _D = 3.5A | -- | 0.76 | 0.9 | Ω |
| g _{FS} | Forward Transconductance | V _{DS} = 40V, I _D = 3.5A | -- | 2.5 | -- | S |
| Dynamic Characteristics | | | | | | |
| C _{iss} | Input Capacitance | V _{DS} = 25V, V _{GS} = 0V, f = 1.0MHz | -- | 720 | 940 | pF |
| C _{oss} | Output Capacitance | | -- | 95 | 190 | pF |
| C _{rss} | Reverse Transfer Capacitance | | -- | 9 | 13.5 | pF |
| Switching Characteristics | | | | | | |
| t _{d(on)} | Turn-On Delay Time | V _{DD} = 250V, I _D = 7A R _G = 25Ω | -- | 6 | 20 | ns |
| t _r | Turn-On Rise Time | | -- | 55 | 120 | ns |
| t _{d(off)} | Turn-Off Delay Time | | -- | 25 | 60 | ns |
| t _f | Turn-Off Fall Time | | (Note 4) | -- | 35 | 80 |
| Q _g | Total Gate Charge | V _{DS} = 400V, I _D = 7A V _{GS} = 10V | -- | 12.8 | 16.6 | nC |
| Q _{gs} | Gate-Source Charge | | -- | 3.7 | -- | nC |
| Q _{gd} | Gate-Drain Charge | | (Note 4) | -- | 5.8 | -- |
| Drain-Source Diode Characteristics and Maximum Ratings | | | | | | |
| I _S | Maximum Continuous Drain-Source Diode Forward Current | | -- | -- | 7 | A |
| I _{SM} | Maximum Pulsed Drain-Source Diode Forward Current | | -- | -- | 28 | A |
| V _{SD} | Drain-Source Diode Forward Voltage | V _{GS} = 0V, I _S = 7A | -- | -- | 1.4 | V |
| t _{rr} | Reverse Recovery Time | V _{GS} = 0V, I _S = 7A di _F /dt = 100A/μs | -- | 275 | -- | ns |
| Q _{rr} | Reverse Recovery Charge | | -- | 1.7 | -- | μC |

NOTES:

1. Repetitive Rating: Pulse width limited by maximum junction temperature
2. I_{AS} = 7A, V_{DD} = 50V, L = 10mH, R_G = 25Ω, Starting T_J = 25°C
3. I_{SD} ≤ 7A, di/dt ≤ 200A/μs, V_{DD} ≤ BV_{DSS}, Starting T_J = 25°C
4. Essentially Independent of Operating Temperature Typical Characteristics

Typical Performance Characteristics

Figure 1. On-Region Characteristics

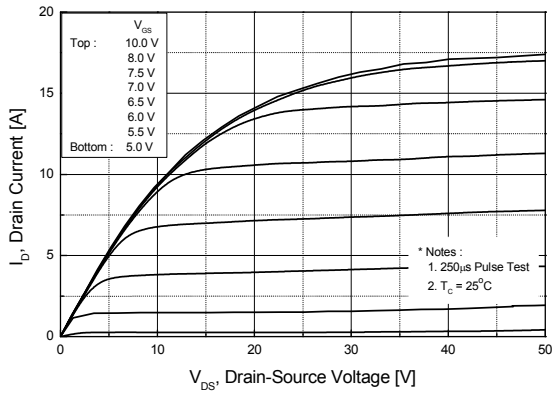

Figure 2. Transfer Characteristics

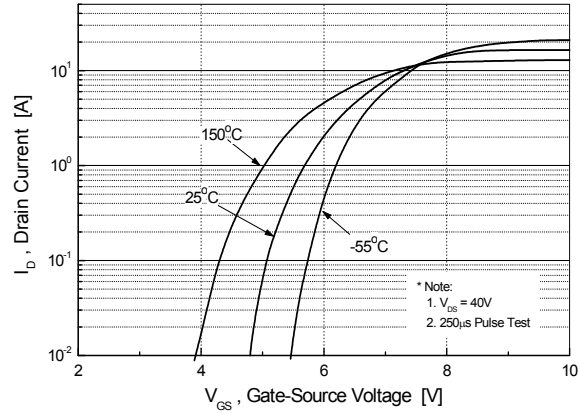

Figure 3. On-Resistance Variation vs. Drain Current and Gate Voltage

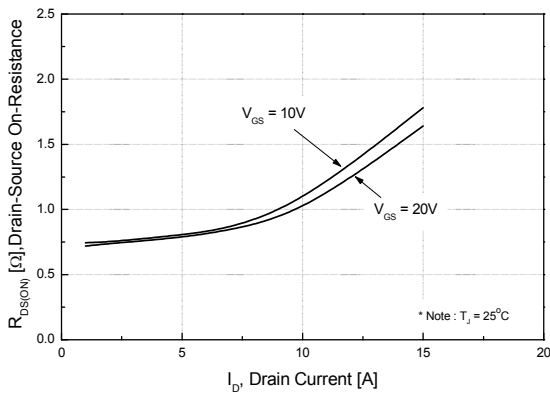

Figure 4. Body Diode Forward Voltage Variation vs. Source Current and Temperature

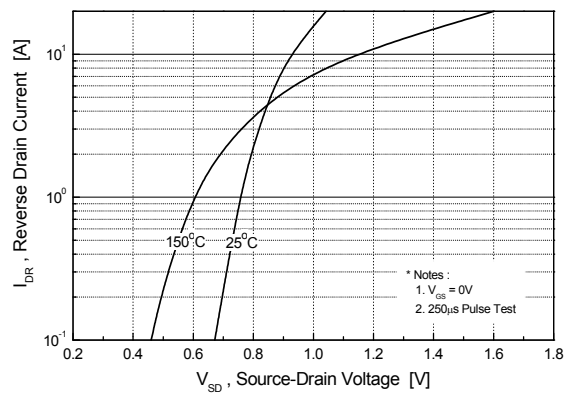

Figure 5. Capacitance Characteristics

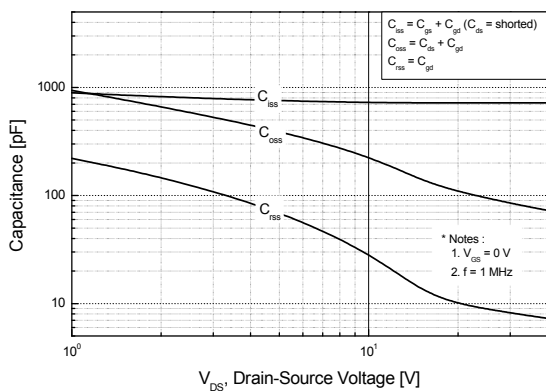
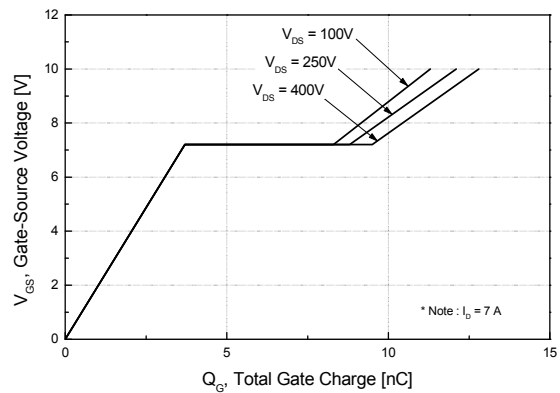

Figure 6. Gate Charge Characteristics



Typical Performance Characteristics (Continued)

Figure 7. Breakdown Voltage Variation vs. Temperature

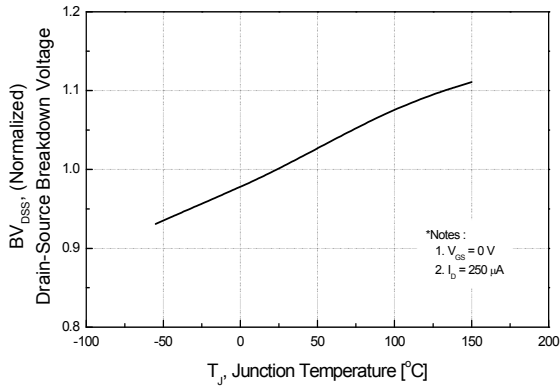

Figure 8. On-Resistance Variation vs. Temperature

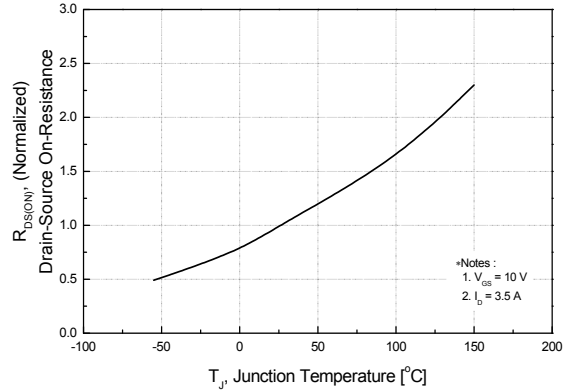

Figure 9. Maximum Safe Operating Area - FDP7N50

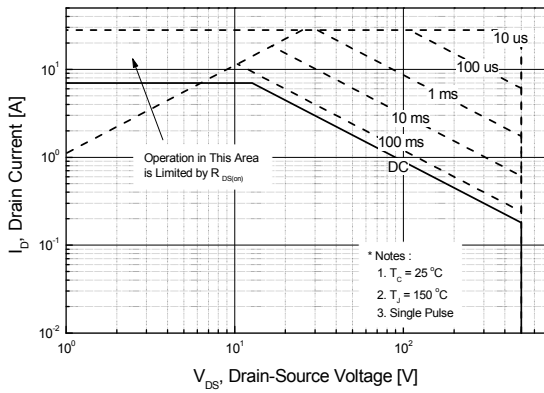

Figure 10. Maximum Drain Current vs. Case Temperature

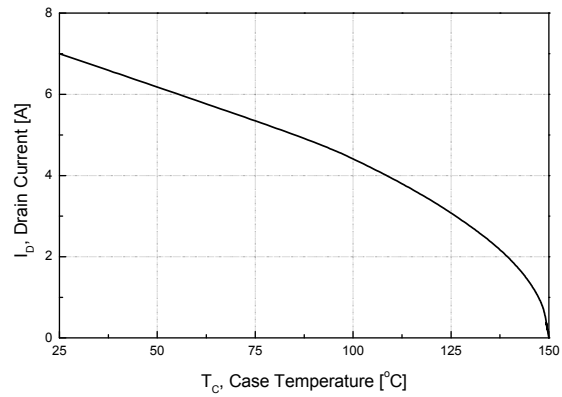
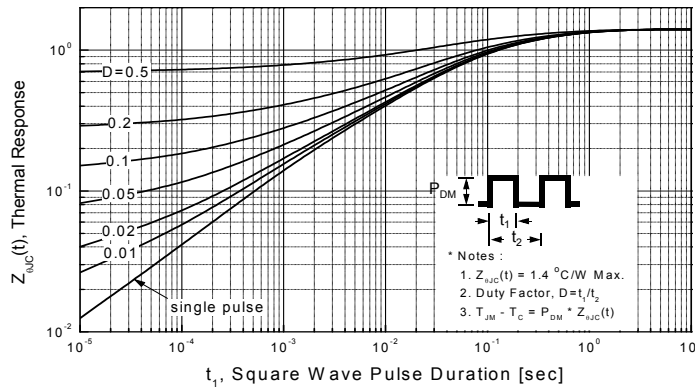
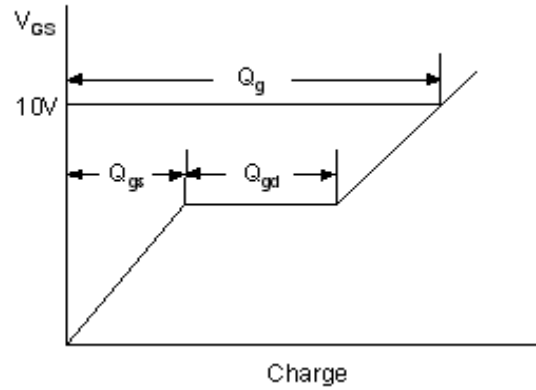
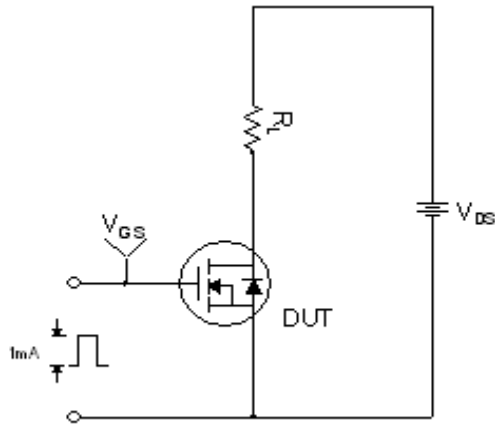

Figure 11. Transient Thermal Response Curve



Gate Charge Test Circuit & Waveform



Resistive Switching Test Circuit & Waveforms

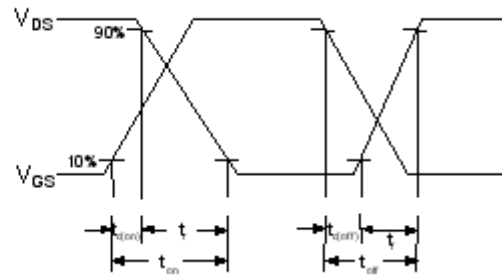
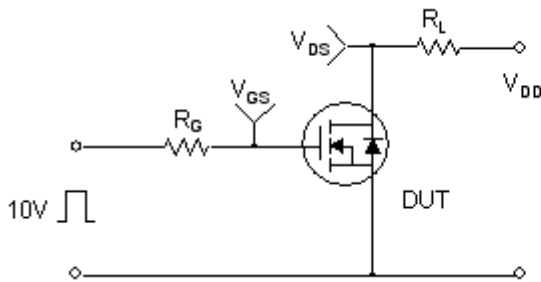

Unclamped Inductive Switching Test Circuit & Waveforms

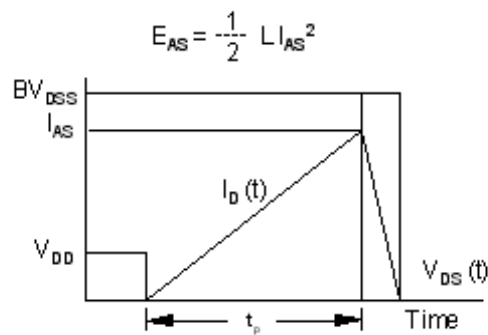
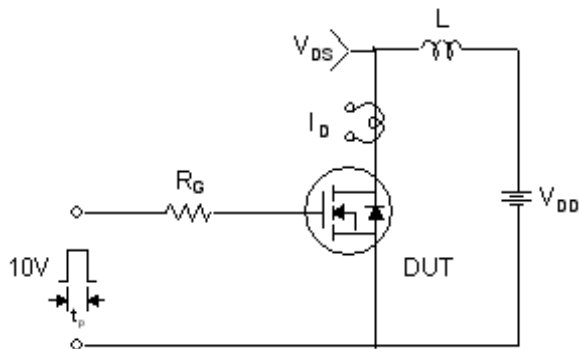

Peak Diode Recovery dv/dt Test Circuit & Waveforms

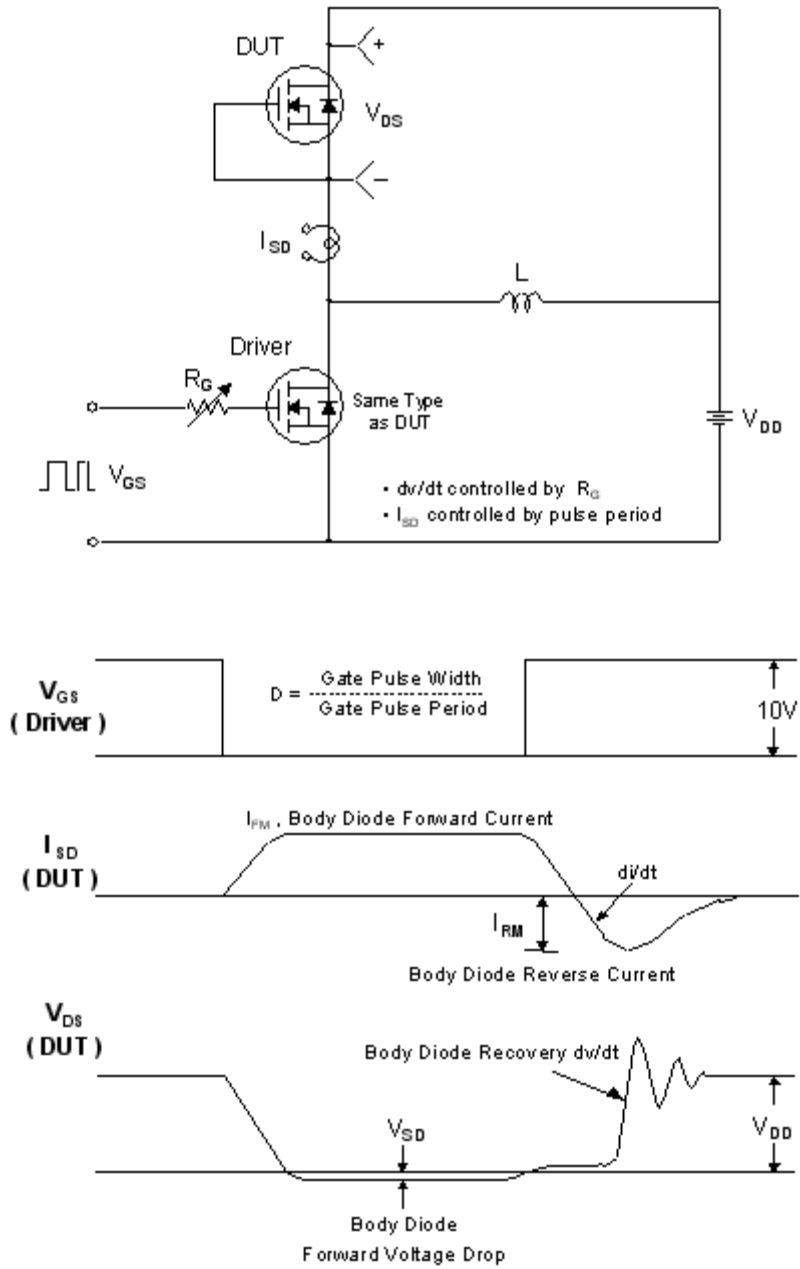

Mechanical Dimensions

TO-220B03

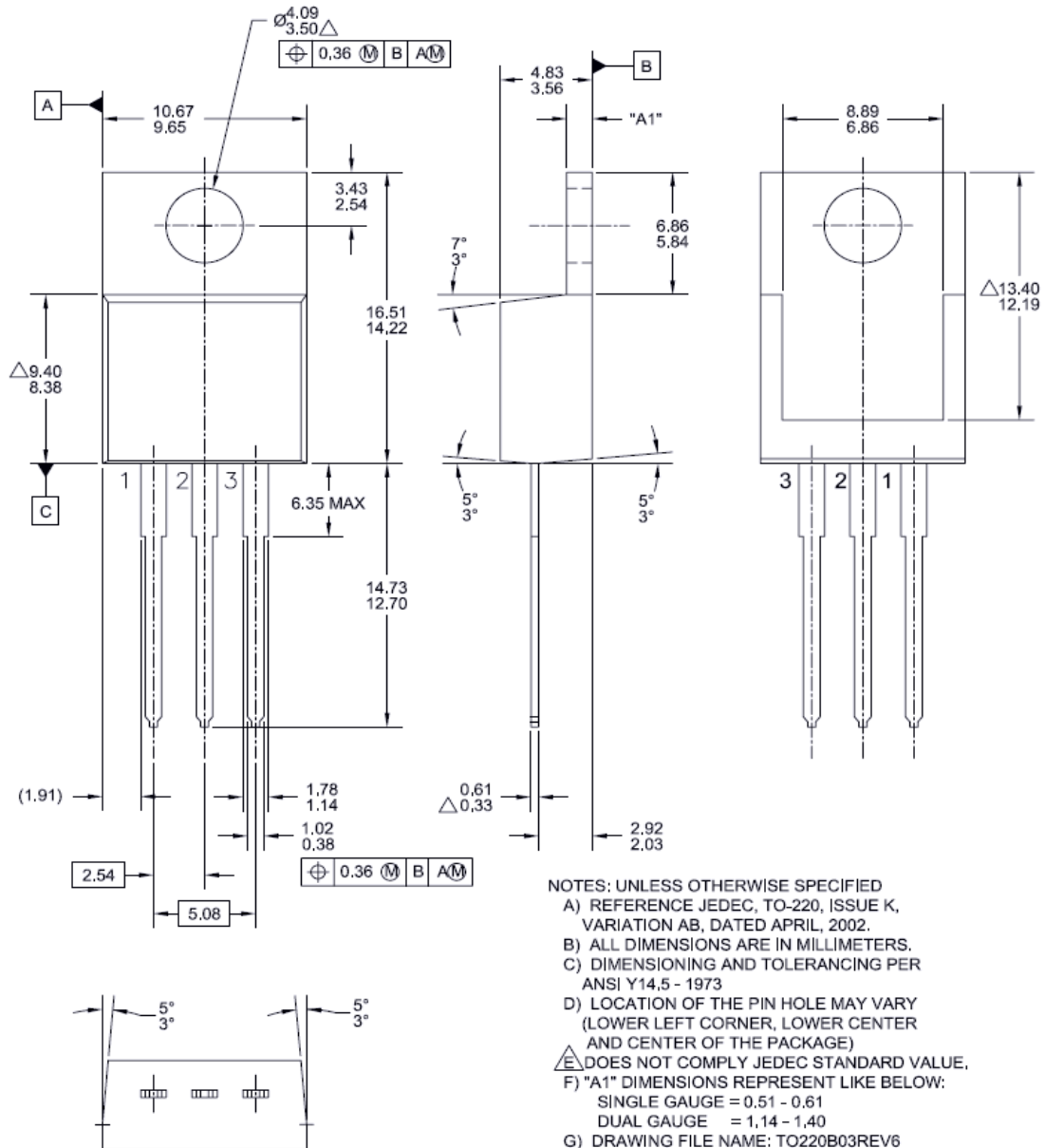

Dimensions in Millimeters



TRADEMARKS

The following includes registered and unregistered trademarks and service marks, owned by Fairchild Semiconductor and/or its global subsidiaries, and is not intended to be an exhaustive list of all such trademarks.

- | | | | |
|--------------------------|---|---|--------------------|
| 2Cool™ | FPS™ | PowerTrench® | Sync-Lock™ |
| AccuPower™ | F-PFS™ | PowerXS™ | E SYSTEM ®* |
| AX-CAP®* | FRFET® | Programmable Active Droop™ | GENERAL |
| BitSiC™ | Global Power ResourceSM | QFET® | TinyBoost™ |
| Build it Now™ | Green Bridge™ | QS™ | TinyBuck™ |
| CorePLUS™ | Green FPS™ | Quiet Series™ | TinyCalc™ |
| CorePOWER™ | Green FPS™ e-Series™ | RapidConfigure™ | TinyLogic® |
| CROSSVOLT™ | Gmax™ | IntelliMAX™ | TINYOPTO™ |
| CTL™ | GTO™ | ISOPLANAR™ | TinyPower™ |
| Current Transfer Logic™ | IntelliMAX™ | Marking Small Speakers Sound Louder and Better™ | TinyPWM™ |
| DEUXPEED® | ISOPLANAR™ | MegaBuck™ | TinyWire™ |
| Dual Cool™ | Marking Small Speakers Sound Louder and Better™ | MICROCOUPLER™ | TranSiC® |
| EcoSPARK® | MegaBuck™ | MicroFET™ | TriFault Detect™ |
| EfficientMax™ | MICROCOUPLER™ | MicroPak™ | TRUECURRENT®* |
| ESBC™ | MicroFET™ | MicroPak2™ | µSerDes™ |
| F ® | MicroPak™ | MillerDrive™ | µSerDes™ |
| Fairchild® | MicroPak2™ | MotionMax™ | UHC® |
| Fairchild Semiconductor® | MillerDrive™ | mWSaver™ | Ultra FRFET™ |
| FACT Quiet Series™ | MotionMax™ | OptoHiT™ | UnifET™ |
| FACT® | mWSaver™ | OPTOLOGIC® | VCX™ |
| FAST® | OptoHiT™ | OPTOPLANAR® | VisualMax™ |
| FastvCore™ | OPTOLOGIC® | PowerTrench® | VoltagePlus™ |
| FETBench™ | OPTOPLANAR® | PowerXS™ | XS™ |
| | | Programmable Active Droop™ | |
| | | QFET® | |
| | | QS™ | |
| | | Quiet Series™ | |
| | | RapidConfigure™ | |
| | | IntelliMAX™ | |
| | | ISOPLANAR™ | |
| | | Marking Small Speakers Sound Louder and Better™ | |
| | | MegaBuck™ | |
| | | MICROCOUPLER™ | |
| | | MicroFET™ | |
| | | MicroPak™ | |
| | | MicroPak2™ | |
| | | MillerDrive™ | |
| | | MotionMax™ | |
| | | mWSaver™ | |
| | | OptoHiT™ | |
| | | OPTOLOGIC® | |
| | | OPTOPLANAR® | |
| | | PowerTrench® | |
| | | PowerXS™ | |
| | | Programmable Active Droop™ | |
| | | QFET® | |
| | | QS™ | |
| | | Quiet Series™ | |
| | | RapidConfigure™ | |
| | | IntelliMAX™ | |
| | | ISOPLANAR™ | |
| | | Marking Small Speakers Sound Louder and Better™ | |
| | | MegaBuck™ | |
| | | MICROCOUPLER™ | |
| | | MicroFET™ | |
| | | MicroPak™ | |
| | | MicroPak2™ | |
| | | MillerDrive™ | |
| | | MotionMax™ | |
| | | mWSaver™ | |
| | | OptoHiT™ | |
| | | OPTOLOGIC® | |
| | | OPTOPLANAR® | |
| | | PowerTrench® | |
| | | PowerXS™ | |
| | | Programmable Active Droop™ | |
| | | QFET® | |
| | | QS™ | |
| | | Quiet Series™ | |
| | | RapidConfigure™ | |
| | | IntelliMAX™ | |
| | | ISOPLANAR™ | |
| | | Marking Small Speakers Sound Louder and Better™ | |
| | | MegaBuck™ | |
| | | MICROCOUPLER™ | |
| | | MicroFET™ | |
| | | MicroPak™ | |
| | | MicroPak2™ | |
| | | MillerDrive™ | |
| | | MotionMax™ | |
| | | mWSaver™ | |
| | | OptoHiT™ | |
| | | OPTOLOGIC® | |
| | | OPTOPLANAR® | |
| | | PowerTrench® | |
| | | PowerXS™ | |
| | | Programmable Active Droop™ | |
| | | QFET® | |
| | | QS™ | |
| | | Quiet Series™ | |
| | | RapidConfigure™ | |
| | | IntelliMAX™ | |
| | | ISOPLANAR™ | |
| | | Marking Small Speakers Sound Louder and Better™ | |
| | | MegaBuck™ | |
| | | MICROCOUPLER™ | |
| | | MicroFET™ | |
| | | MicroPak™ | |
| | | MicroPak2™ | |
| | | MillerDrive™ | |
| | | MotionMax™ | |
| | | mWSaver™ | |
| | | OptoHiT™ | |
| | | OPTOLOGIC® | |
| | | OPTOPLANAR® | |
| | | PowerTrench® | |
| | | PowerXS™ | |
| | | Programmable Active Droop™ | |
| | | QFET® | |
| | | QS™ | |
| | | Quiet Series™ | |
| | | RapidConfigure™ | |
| | | IntelliMAX™ | |
| | | ISOPLANAR™ | |
| | | Marking Small Speakers Sound Louder and Better™ | |
| | | MegaBuck™ | |
| | | MICROCOUPLER™ | |
| | | MicroFET™ | |
| | | MicroPak™ | |
| | | MicroPak2™ | |
| | | MillerDrive™ | |
| | | MotionMax™ | |
| | | mWSaver™ | |
| | | OptoHiT™ | |
| | | OPTOLOGIC® | |
| | | OPTOPLANAR® | |
| | | PowerTrench® | |
| | | PowerXS™ | |
| | | Programmable Active Droop™ | |
| | | QFET® | |
| | | QS™ | |
| | | Quiet Series™ | |
| | | RapidConfigure™ | |
| | | IntelliMAX™ | |
| | | ISOPLANAR™ | |
| | | Marking Small Speakers Sound Louder and Better™ | |
| | | MegaBuck™ | |
| | | MICROCOUPLER™ | |
| | | MicroFET™ | |
| | | MicroPak™ | |
| | | MicroPak2™ | |
| | | MillerDrive™ | |
| | | MotionMax™ | |
| | | mWSaver™ | |
| | | OptoHiT™ | |
| | | OPTOLOGIC® | |
| | | OPTOPLANAR® | |
| | | PowerTrench® | |
| | | PowerXS™ | |
| | | Programmable Active Droop™ | |
| | | QFET® | |
| | | QS™ | |
| | | Quiet Series™ | |
| | | RapidConfigure™ | |
| | | IntelliMAX™ | |
| | | ISOPLANAR™ | |
| | | Marking Small Speakers Sound Louder and Better™ | |
| | | MegaBuck™ | |
| | | MICROCOUPLER™ | |
| | | MicroFET™ | |
| | | MicroPak™ | |
| | | MicroPak2™ | |
| | | MillerDrive™ | |
| | | MotionMax™ | |
| | | mWSaver™ | |
| | | OptoHiT™ | |
| | | OPTOLOGIC® | |
| | | OPTOPLANAR® | |
| | | PowerTrench® | |
| | | PowerXS™ | |
| | | Programmable Active Droop™ | |
| | | QFET® | |
| | | QS™ | |
| | | Quiet Series™ | |
| | | RapidConfigure™ | |
| | | IntelliMAX™ | |
| | | ISOPLANAR™ | |
| | | Marking Small Speakers Sound Louder and Better™ | |
| | | MegaBuck™ | |
| | | MICROCOUPLER™ | |
| | | MicroFET™ | |
| | | MicroPak™ | |
| | | MicroPak2™ | |
| | | MillerDrive™ | |
| | | MotionMax™ | |
| | | mWSaver™ | |
| | | OptoHiT™ | |
| | | OPTOLOGIC® | |
| | | OPTOPLANAR® | |
| | | PowerTrench® | |
| | | PowerXS™ | |
| | | Programmable Active Droop™ | |
| | | QFET® | |
| | | QS™ | |
| | | Quiet Series™ | |
| | | RapidConfigure™ | |
| | | IntelliMAX™ | |
| | | ISOPLANAR™ | |
| | | Marking Small Speakers Sound Louder and Better™ | |
| | | MegaBuck™ | |
| | | MICROCOUPLER™ | |
| | | MicroFET™ | |
| | | MicroPak™ | |
| | | MicroPak2™ | |
| | | MillerDrive™ | |
| | | MotionMax™ | |
| | | mWSaver™ | |
| | | OptoHiT™ | |
| | | OPTOLOGIC® | |
| | | OPTOPLANAR® | |
| | | PowerTrench® | |
| | | PowerXS™ | |
| | | Programmable Active Droop™ | |
| | | QFET® | |
| | | QS™ | |
| | | Quiet Series™ | |
| | | RapidConfigure™ | |
| | | IntelliMAX™ | |
| | | ISOPLANAR™ | |
| | | Marking Small Speakers Sound Louder and Better™ | |
| | | MegaBuck™ | |
| | | MICROCOUPLER™ | |
| | | MicroFET™ | |
| | | MicroPak™ | |
| | | MicroPak2™ | |
| | | MillerDrive™ | |
| | | MotionMax™ | |
| | | mWSaver™ | |
| | | OptoHiT™ | |
| | | OPTOLOGIC® | |
| | | OPTOPLANAR® | |
| | | PowerTrench® | |
| | | PowerXS™ | |
| | | Programmable Active Droop™ | |
| | | QFET® | |
| | | QS™ | |
| | | Quiet Series™ | |
| | | RapidConfigure™ | |
| | | IntelliMAX™ | |
| | | ISOPLANAR™ | |
| | | Marking Small Speakers Sound Louder and Better™ | |
| | | MegaBuck™ | |
| | | MICROCOUPLER™ | |
| | | MicroFET™ | |
| | | MicroPak™ | |
| | | MicroPak2™ | |
| | | MillerDrive™ | |
| | | MotionMax™ | |
| | | mWSaver™ | |
| | | OptoHiT™ | |
| | | OPTOLOGIC® | |
| | | OPTOPLANAR® | |
| | | PowerTrench® | |
| | | PowerXS™ | |
| | | Programmable Active Droop™ | |
| | | QFET® | |
| | | QS™ | |
| | | Quiet Series™ | |
| | | RapidConfigure™ | |
| | | IntelliMAX™ | |
| | | ISOPLANAR™ | |
| | | Marking Small Speakers Sound Louder and Better™ | |
| | | MegaBuck™ | |
| | | MICROCOUPLER™ | |
| | | MicroFET™ | |
| | | MicroPak™ | |
| | | MicroPak2™ | |
| | | MillerDrive™ | |
| | | MotionMax™ | |
| | | mWSaver™ | |
| | | OptoHiT™ | |
| | | OPTOLOGIC® | |
| | | OPTOPLANAR® | |
| | | PowerTrench® | |
| | | PowerXS™ | |
| | | Programmable Active Droop™ | |
| | | QFET® | |
| | | QS™ | |
| | | Quiet Series™ | |
| | | RapidConfigure™ | |
| | | IntelliMAX™ | |
| | | ISOPLANAR™ | |
| | | Marking Small Speakers Sound Louder and Better™ | |
| | | MegaBuck™ | |
| | | MICROCOUPLER™ | |
| | | MicroFET™ | |
| | | MicroPak™ | |
| | | MicroPak2™ | |
| | | MillerDrive™ | |
| | | MotionMax™ | |
| | | mWSaver™ | |
| | | OptoHiT™ | |
| | | OPTOLOGIC® | |
| | | OPTOPLANAR® | |
| | | PowerTrench® | |
| | | PowerXS™ | |
| | | Programmable Active Droop™ | |
| | | QFET® | |
| | | QS™ | |
| | | Quiet Series™ | |
| | | RapidConfigure™ | |
| | | IntelliMAX™ | |
| | | ISOPLANAR™ | |
| | | Marking Small Speakers Sound Louder and Better™ | |
| | | MegaBuck™ | |
| | | MICROCOUPLER™ | |
| | | MicroFET™ | |
| | | MicroPak™ | |
| | | MicroPak2™ | |
| | | MillerDrive™ | |
| | | MotionMax™ | |
| | | mWSaver™ | |
| | | OptoHiT™ | |
| | | OPTOLOGIC® | |
| | | OPTOPLANAR® | |
| | | PowerTrench® | |
| | | PowerXS™ | |
| | | Programmable Active Droop™ | |
| | | QFET® | |
| | | QS™ | |
| | | Quiet Series™ | |
| | | RapidConfigure™ | |
| | | IntelliMAX™ | |
| | | ISOPLANAR™ | |
| | | Marking Small Speakers Sound Louder and Better™ | |
| | | MegaBuck™ | |
| | | MICROCOUPLER™ | |
| | | MicroFET™ | |
| | | MicroPak™ | |
| | | MicroPak2™ | |
| | | MillerDrive™ | |
| | | MotionMax™ | |
| | | mWSaver™ | |
| | | OptoHiT™ | |
| | | OPTOLOGIC® | |
| | | OPTOPLANAR® | |
| | | PowerTrench® | |
| | | PowerXS™ | |
| | | Programmable Active Droop™ | |
| | | QFET® | |
| | | QS™ | |
| | | Quiet Series™ | |
| | | RapidConfigure™ | |
| | | IntelliMAX™ | |
| | | ISOPLANAR™ | |
| | | Marking Small Speakers Sound Louder and Better™ | |
| | | MegaBuck™ | |
| | | MICROCOUPLER™ | |
| | | MicroFET™ | |
| | | MicroPak™ | |
| | | MicroPak2™ | |
| | | MillerDrive™ | |
| | | MotionMax™ | |
| | | mWSaver™ | |
| | | OptoHiT™ | |
| | | OPTOLOGIC® | |
| | | OPTOPLANAR® | |
| | | PowerTrench® | |
| | | PowerXS™ | |
| | | Programmable Active Droop™ | |
| | | QFET® | |
| | | QS™ | |
| | | Quiet Series™ | |
| | | | |

ON Semiconductor and  are trademarks of Semiconductor Components Industries, LLC dba ON Semiconductor or its subsidiaries in the United States and/or other countries. ON Semiconductor owns the rights to a number of patents, trademarks, copyrights, trade secrets, and other intellectual property. A listing of ON Semiconductor's product/patent coverage may be accessed at www.onsemi.com/site/pdf/Patent-Marking.pdf. ON Semiconductor reserves the right to make changes without further notice to any products herein. ON Semiconductor makes no warranty, representation or guarantee regarding the suitability of its products for any particular purpose, nor does ON Semiconductor assume any liability arising out of the application or use of any product or circuit, and specifically disclaims any and all liability, including without limitation special, consequential or incidental damages. Buyer is responsible for its products and applications using ON Semiconductor products, including compliance with all laws, regulations and safety requirements or standards, regardless of any support or applications information provided by ON Semiconductor. "Typical" parameters which may be provided in ON Semiconductor data sheets and/or specifications can and do vary in different applications and actual performance may vary over time. All operating parameters, including "Typicals" must be validated for each customer application by customer's technical experts. ON Semiconductor does not convey any license under its patent rights nor the rights of others. ON Semiconductor products are not designed, intended, or authorized for use as a critical component in life support systems or any FDA Class 3 medical devices or medical devices with a same or similar classification in a foreign jurisdiction or any devices intended for implantation in the human body. Should Buyer purchase or use ON Semiconductor products for any such unintended or unauthorized application, Buyer shall indemnify and hold ON Semiconductor and its officers, employees, subsidiaries, affiliates, and distributors harmless against all claims, costs, damages, and expenses, and reasonable attorney fees arising out of, directly or indirectly, any claim of personal injury or death associated with such unintended or unauthorized use, even if such claim alleges that ON Semiconductor was negligent regarding the design or manufacture of the part. ON Semiconductor is an Equal Opportunity/Affirmative Action Employer. This literature is subject to all applicable copyright laws and is not for resale in any manner.

PUBLICATION ORDERING INFORMATION

LITERATURE FULFILLMENT:

Literature Distribution Center for ON Semiconductor
19521 E. 32nd Pkwy, Aurora, Colorado 80011 USA
Phone: 303-675-2175 or 800-344-3860 Toll Free USA/Canada
Fax: 303-675-2176 or 800-344-3867 Toll Free USA/Canada
Email: orderlit@onsemi.com

N. American Technical Support: 800-282-9855 Toll Free
USA/Canada
Europe, Middle East and Africa Technical Support:
Phone: 421 33 790 2910
Japan Customer Focus Center
Phone: 81-3-5817-1050

ON Semiconductor Website: www.onsemi.com
Order Literature: <http://www.onsemi.com/orderlit>
For additional information, please contact your local
Sales Representative