

Molded transformer terminal block - VTRK 4 GY - 3004605

Please be informed that the data shown in this PDF Document is generated from our Online Catalog. Please find the complete data in the user's documentation. Our General Terms of Use for Downloads are valid (<http://phoenixcontact.com/download>)



Molded transformer terminal block, Connection method: Screw connection, Length: 23.4 mm, Width: 12.4 mm, Height: 17.2 mm, Color: gray



Key commercial data

Packing unit	1 pc
Weight per Piece (excluding packing)	7.56 GRM
Custom tariff number	85369010
Country of origin	Poland

Technical data

General

Number of connections	4
Color	gray
Insulating material	PA
Inflammability class according to UL 94	V0
Rated surge voltage	4 kV
Rated insulation voltage	250 V
Pollution degree	3
Surge voltage category	III
Nominal current I_N	25 A
Nominal voltage U_N	voltage data only possible in conjunction with transformer
Number of positions	2

Dimensions

Width	12.4 mm
Length	23.4 mm
Height	17.2 mm

Molded transformer terminal block - VTRK 4 GY - 3004605

Technical data

Connection data

Conductor cross section solid min.	0.2 mm ²
Conductor cross section solid max.	6 mm ²
Conductor cross section stranded min.	0.2 mm ²
Conductor cross section stranded max.	4 mm ²
Conductor cross section AWG/kcmil min.	24
Conductor cross section AWG/kcmil max	10
Conductor cross section stranded, with ferrule without plastic sleeve min.	0.25 mm ²
Conductor cross section stranded, with ferrule without plastic sleeve max.	4 mm ²
Conductor cross section stranded, with ferrule with plastic sleeve min.	0.25 mm ²
Conductor cross section stranded, with ferrule with plastic sleeve max.	2.5 mm ²
2 conductors with same cross section, solid min.	0.2 mm ²
2 conductors with same cross section, solid max.	1.5 mm ²
2 conductors with same cross section, stranded min.	0.2 mm ²
2 conductors with same cross section, stranded max.	1.5 mm ²
2 conductors with same cross section, stranded, ferrules without plastic sleeve, min.	0.25 mm ²
2 conductors with same cross section, stranded, ferrules without plastic sleeve, max.	1.5 mm ²
2 conductors with same cross section, stranded, TWIN ferrules with plastic sleeve, min.	0.5 mm ²
2 conductors with same cross section, stranded, TWIN ferrules with plastic sleeve, max.	2.5 mm ²
Connection method	Screw connection
Stripping length	8 mm
Internal cylindrical gage	A4
Screw thread	M3
Tightening torque, min	0.6 Nm
Tightening torque max	0.8 Nm

Classifications

eCl@ss

eCl@ss 4.0	27141110
eCl@ss 4.1	27141110
eCl@ss 5.0	27141110
eCl@ss 5.1	27141110
eCl@ss 6.0	27141110
eCl@ss 7.0	27141110

Molded transformer terminal block - VTRK 4 GY - 3004605

Classifications

eCl@ss

eCl@ss 8.0	27141190
------------	----------

ETIM

ETIM 2.0	EC001283
ETIM 3.0	EC001283
ETIM 4.0	EC000398
ETIM 5.0	EC000398

UNSPSC

UNSPSC 6.01	30211811
UNSPSC 7.0901	39121410
UNSPSC 11	39121410
UNSPSC 12.01	39121410
UNSPSC 13.2	39121410

Approvals

Approvals

Approvals

CSA / UL Recognized / cUL Recognized / GOST / GOST / cULus Recognized

Ex Approvals

Approvals submitted

Approval details

CSA 			
		B	D
mm ² /AWG/kcmil	28-10	24-10	24-10
Nominal current IN	30 A	35 A	10 A
Nominal voltage UN	300 V	150 V	300 V

Molded transformer terminal block - VTRK 4 GY - 3004605

Approvals

UL Recognized		
	B	C
mm ² /AWG/kcmil	30-10	30-10
Nominal current I _N	30 A	30 A
Nominal voltage U _N	300 V	300 V

cUL Recognized		
	B	C
mm ² /AWG/kcmil	30-10	30-10
Nominal current I _N	30 A	30 A
Nominal voltage U _N	300 V	300 V

GOST		
------	--	--

GOST		
------	--	--

cULus Recognized		
------------------	--	--

Drawings

Molded transformer terminal block - VTRK 4 GY - 3004605

Dimensioned drawing

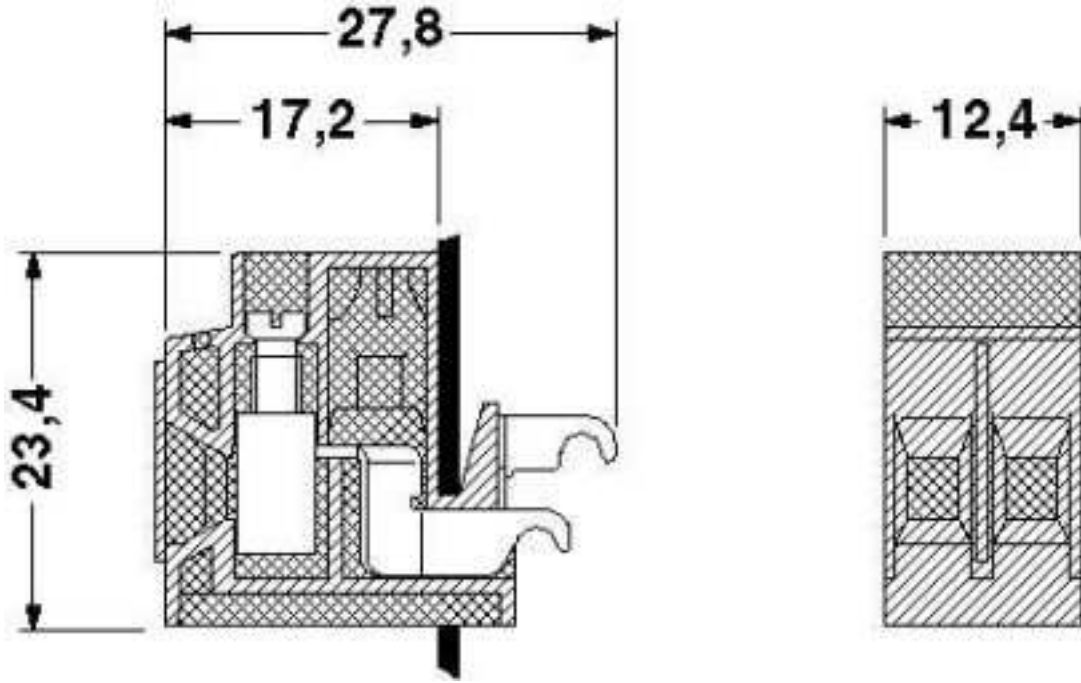

Dimensioned drawing

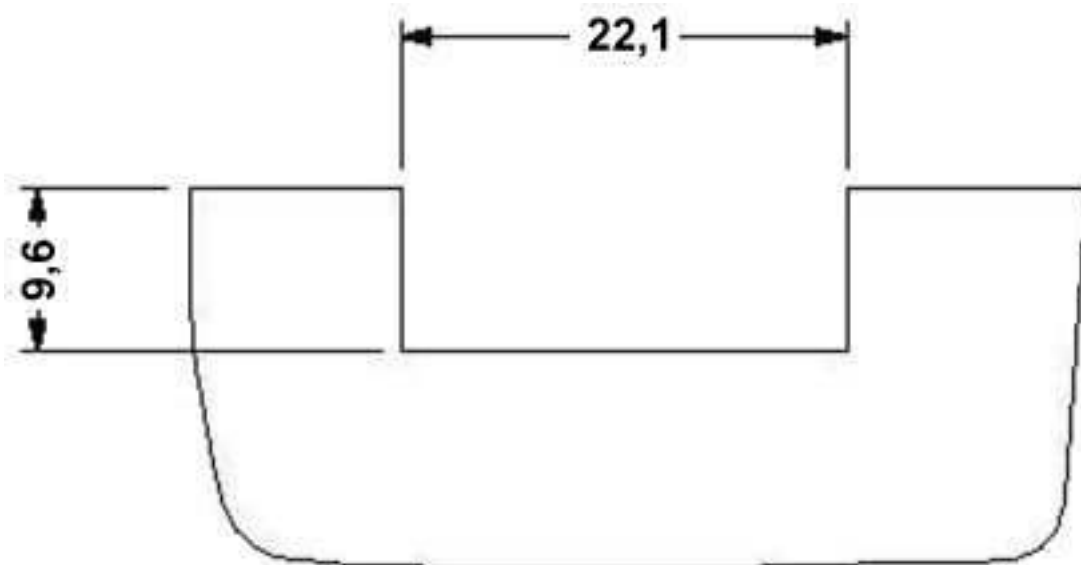

Housing cutout (panel thickness 1.8) for two transformer terminal blocks

Molded transformer terminal block - VTRK 4 GY - 3004605

Dimensioned drawing

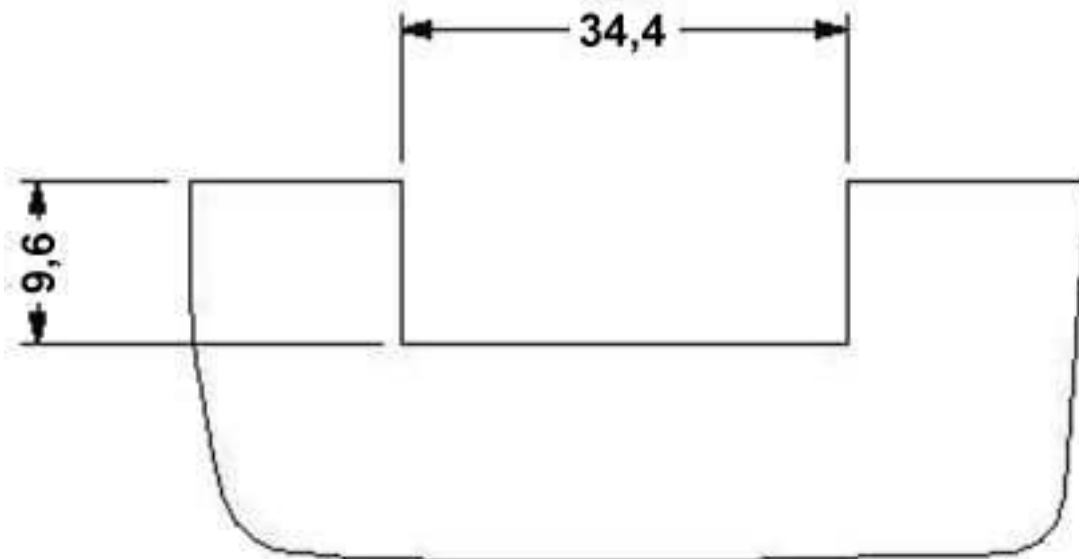

Housing cutout (panel thickness 1.8) for three transformer terminal blocks

Dimensioned drawing

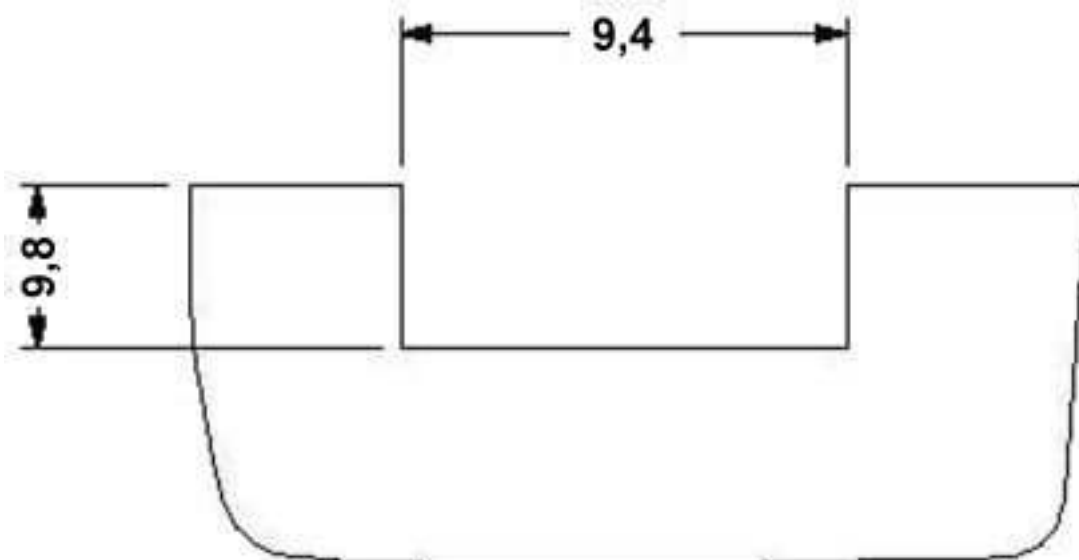

Housing cutout (panel thickness 1.9) for one transformer terminal block

Molded transformer terminal block - VTRK 4 GY - 3004605

Dimensioned drawing

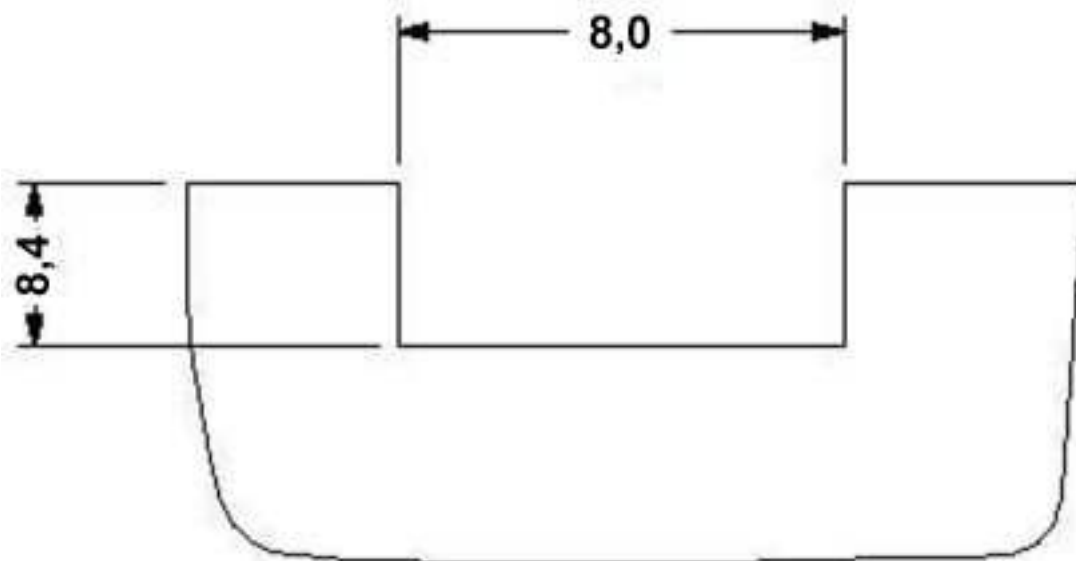

Housing cutout (panel thickness 1.2) for one transformer terminal block

Dimensioned drawing

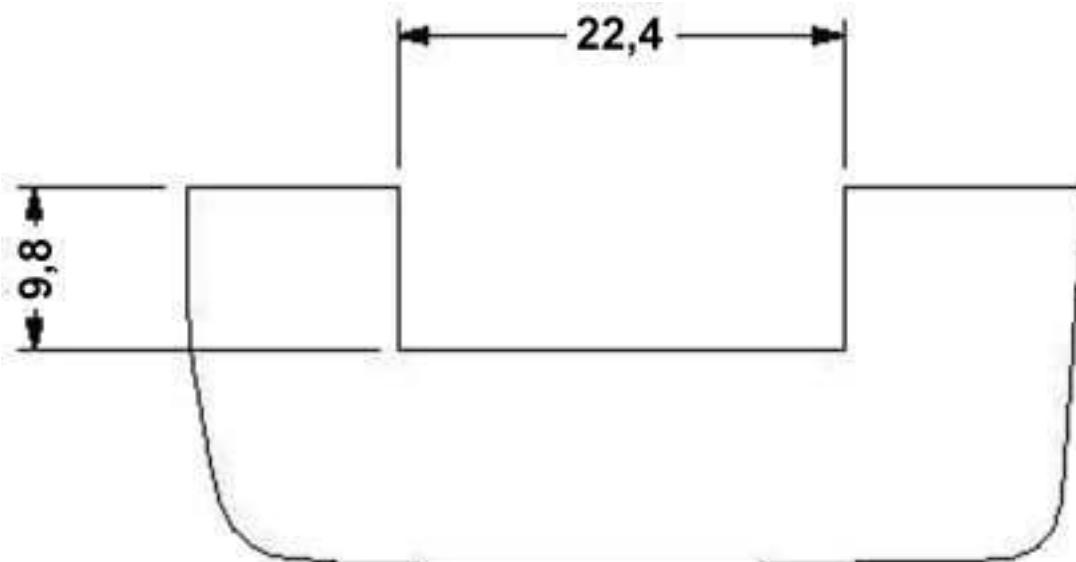

Housing cutout (panel thickness 1.9) for two transformer terminal blocks

Molded transformer terminal block - VTRK 4 GY - 3004605

Dimensioned drawing

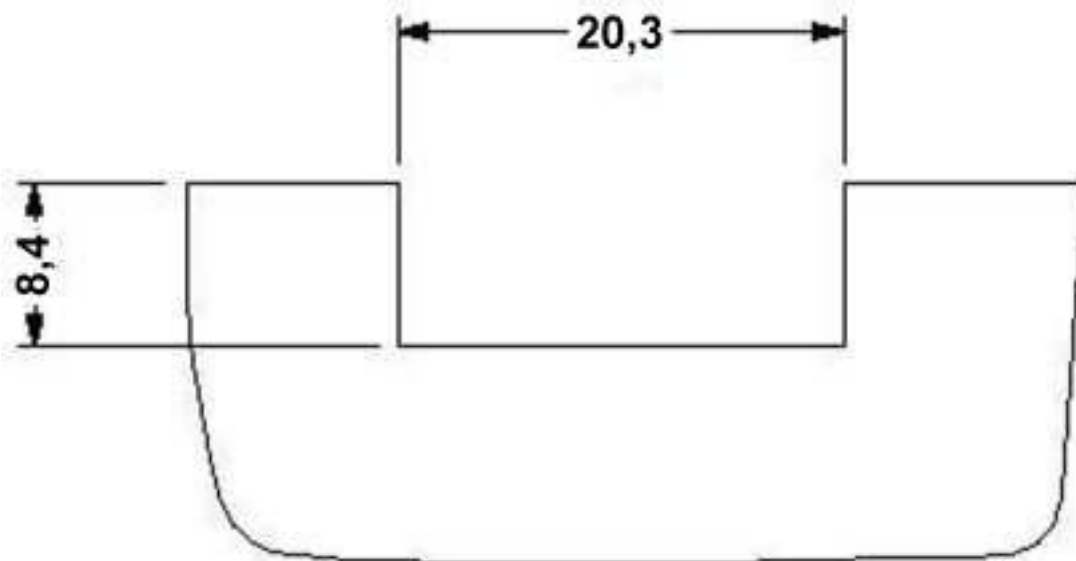

Housing cutout (panel thickness 1.2) for two transformer terminal blocks

Dimensioned drawing

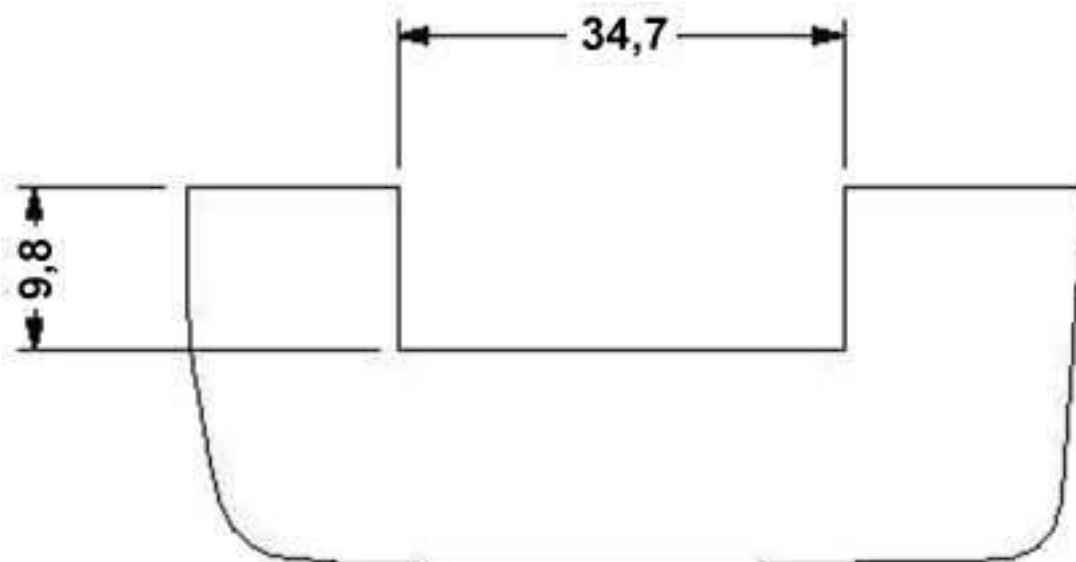

Housing cutout (panel thickness 1.9) for three transformer terminal blocks

Molded transformer terminal block - VTRK 4 GY - 3004605

Dimensioned drawing

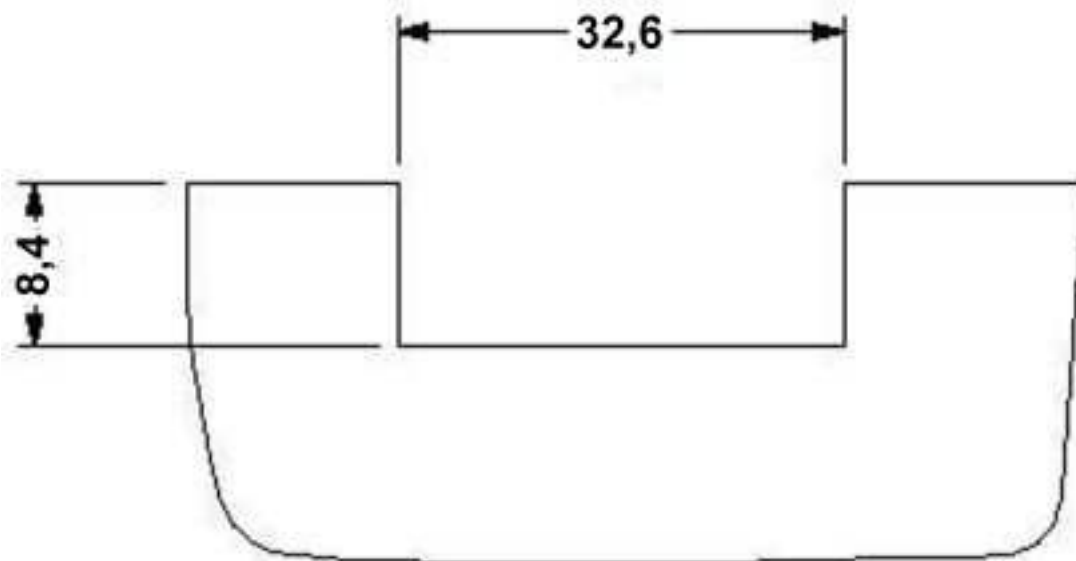

Housing cutout (panel thickness 1.2) for three transformer terminal blocks

Dimensioned drawing

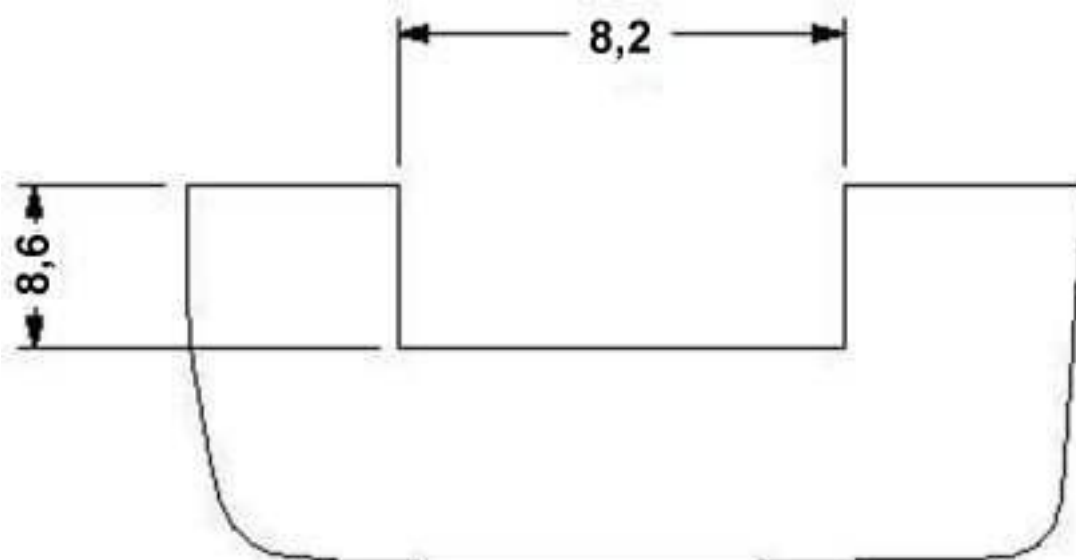

Housing cutout (panel thickness 1.3) for one transformer terminal block

Molded transformer terminal block - VTRK 4 GY - 3004605

Dimensioned drawing

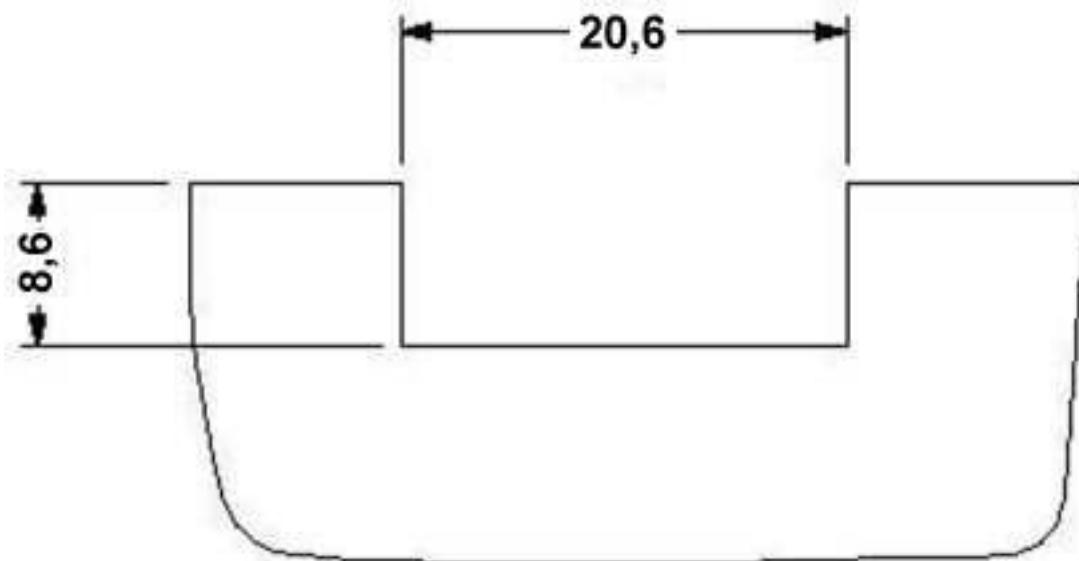

Housing cutout (panel thickness 1.3) for two transformer terminal blocks

Dimensioned drawing

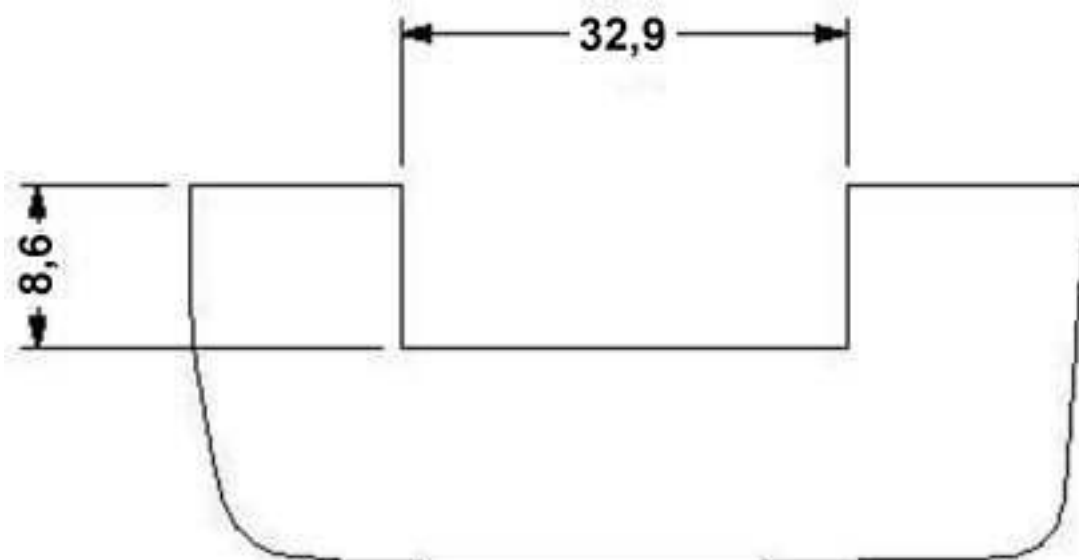

Housing cutout (panel thickness 1.3) for three transformer terminal blocks

Molded transformer terminal block - VTRK 4 GY - 3004605

Dimensioned drawing

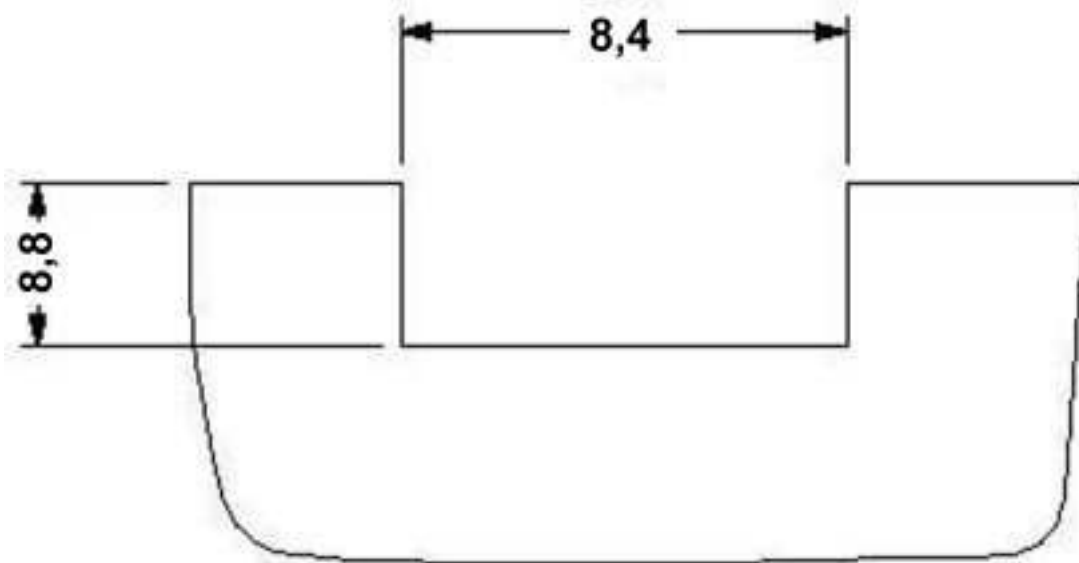

Housing cutout (panel thickness 1.4) for one transformer terminal block

Dimensioned drawing

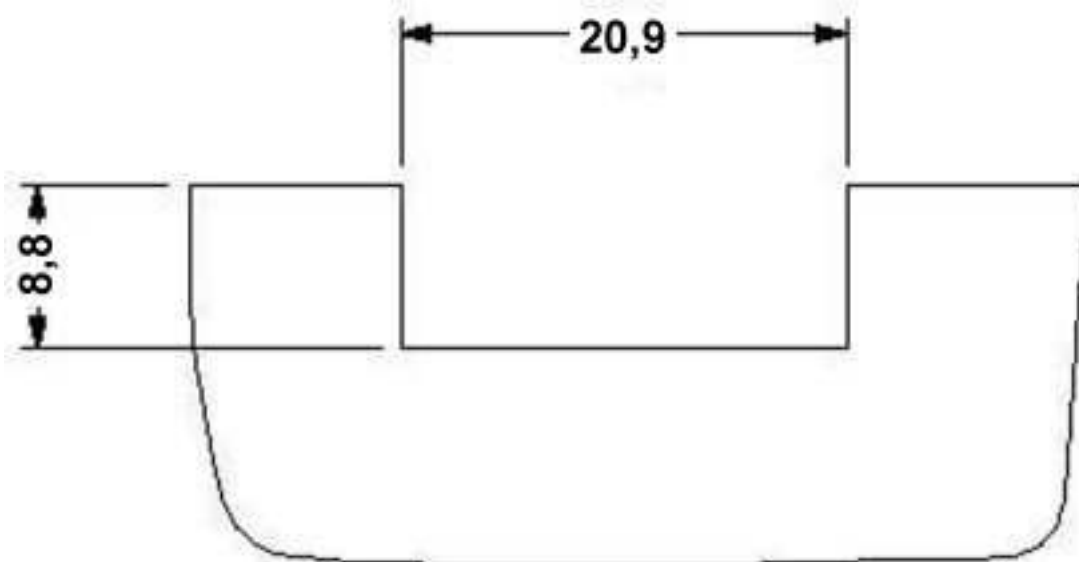

Housing cutout (panel thickness 1.4) for two transformer terminal blocks

Molded transformer terminal block - VTRK 4 GY - 3004605

Dimensioned drawing

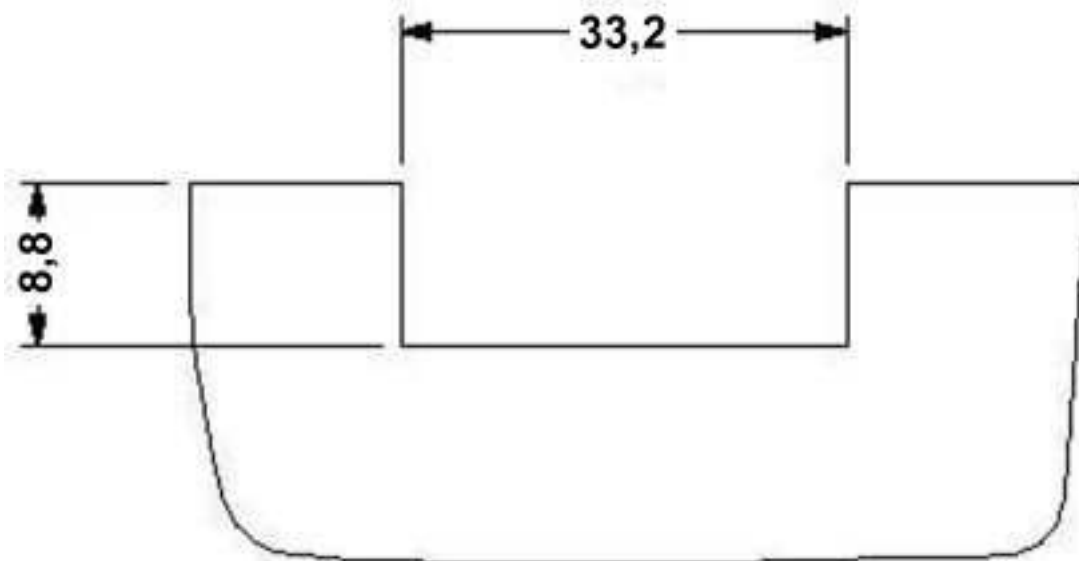

Housing cutout (panel thickness 1.4) for three transformer terminal blocks

Dimensioned drawing

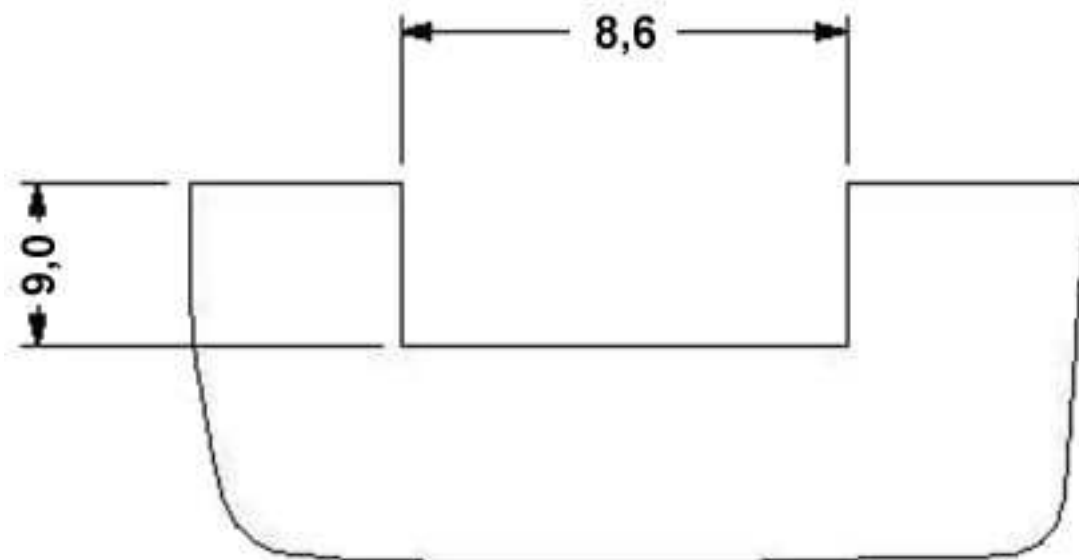

Housing cutout (panel thickness 1.5) for one transformer terminal block

Molded transformer terminal block - VTRK 4 GY - 3004605

Dimensioned drawing

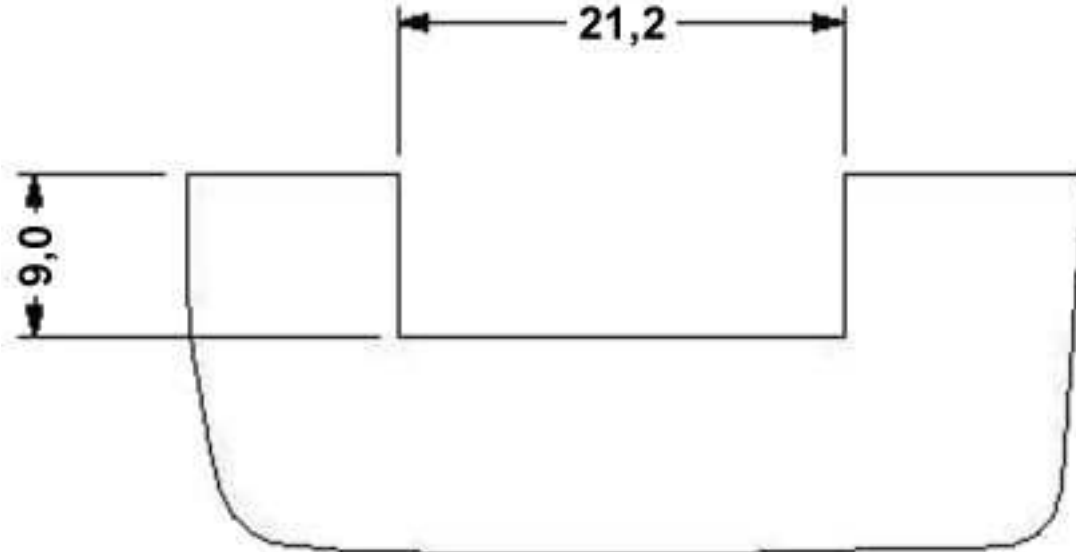

Housing cutout (panel thickness 1.5) for two transformer terminal blocks

Dimensioned drawing

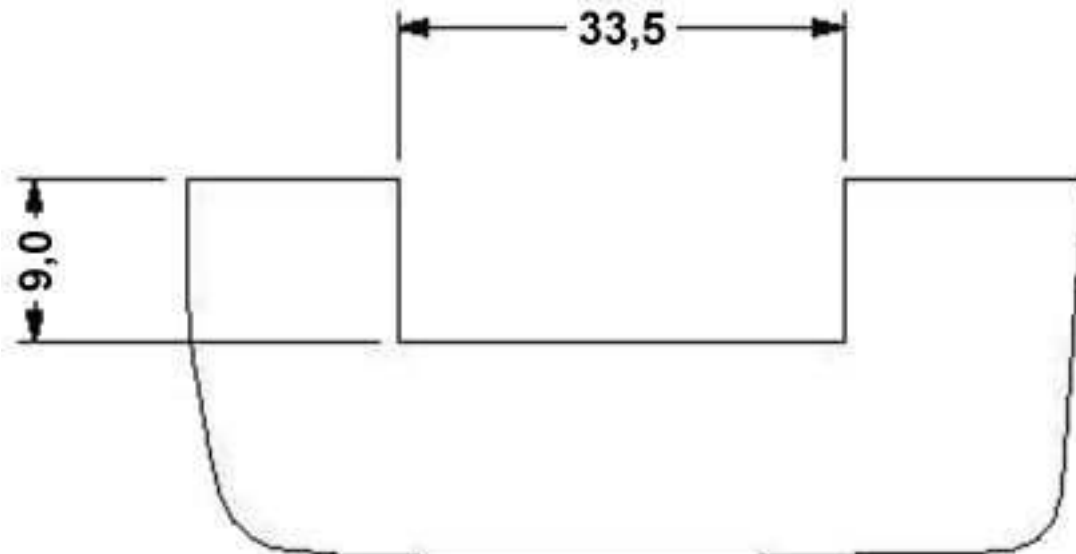

Housing cutout (panel thickness 1.5) for three transformer terminal blocks

Molded transformer terminal block - VTRK 4 GY - 3004605

Dimensioned drawing

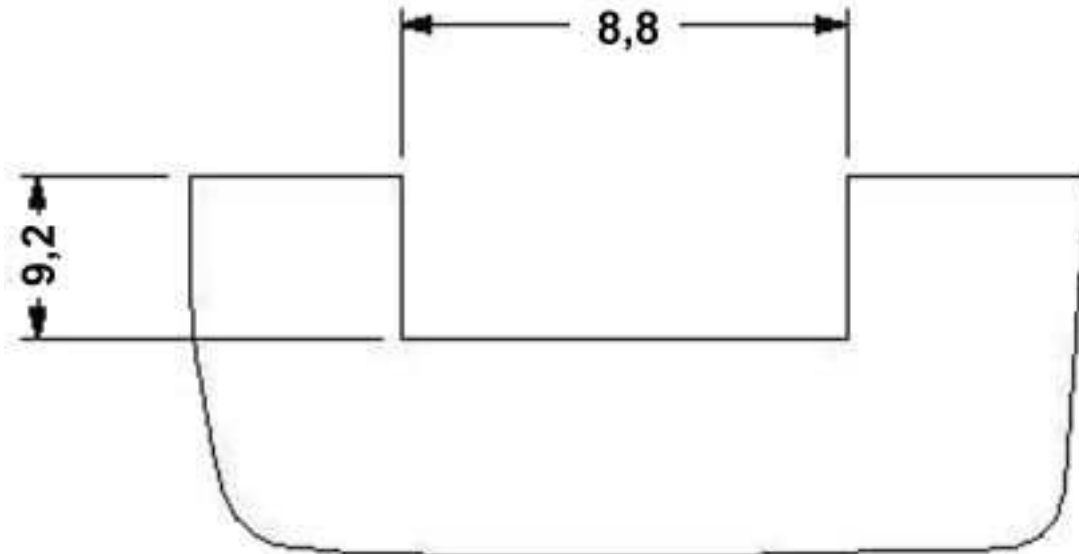

Housing cutout (panel thickness 1.6) for one transformer terminal block

Dimensioned drawing

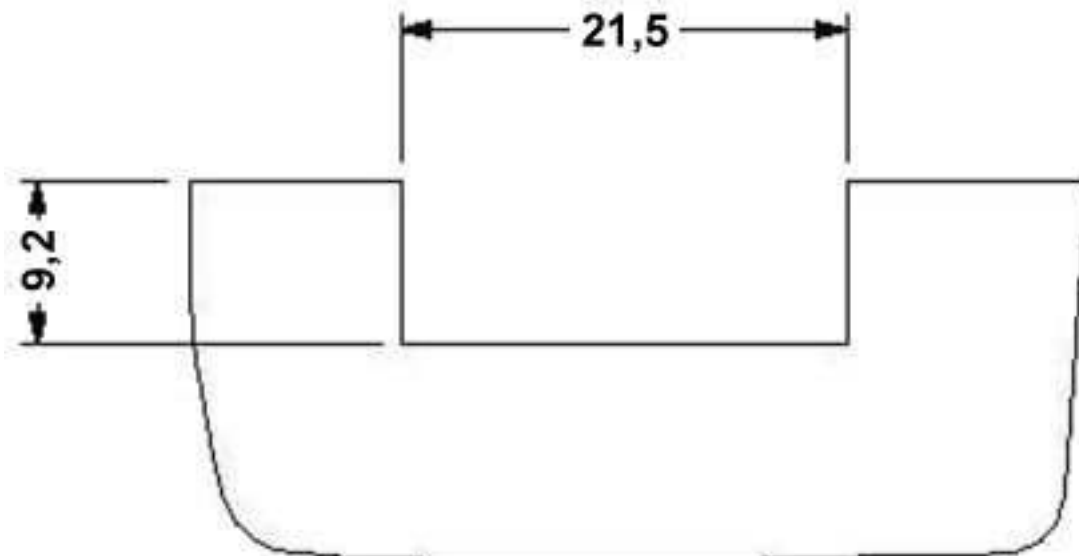

Housing cutout (panel thickness 1.6) for two transformer terminal blocks

Molded transformer terminal block - VTRK 4 GY - 3004605

Dimensioned drawing

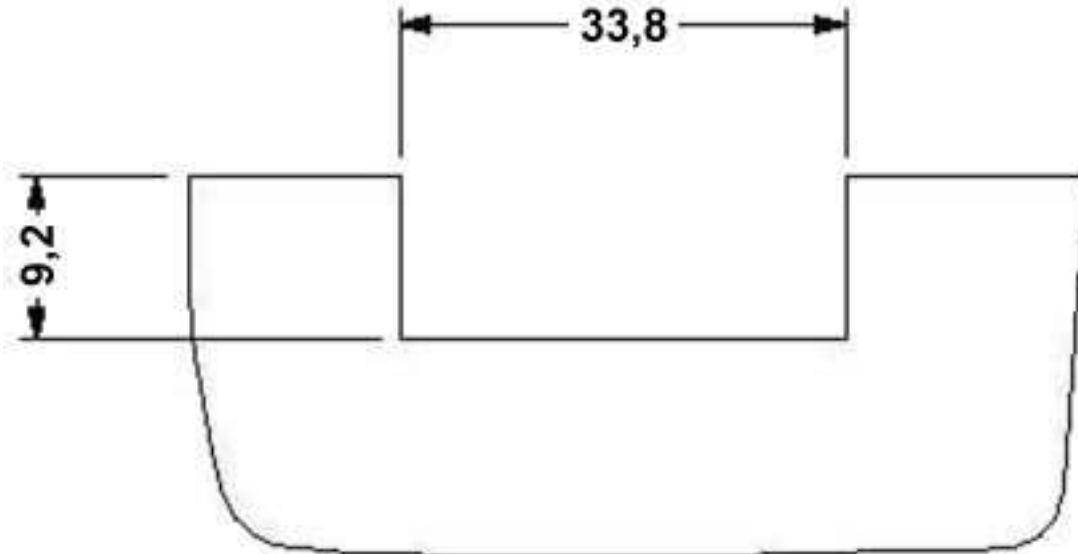

Housing cutout (panel thickness 1.6) for three transformer terminal blocks

Dimensioned drawing

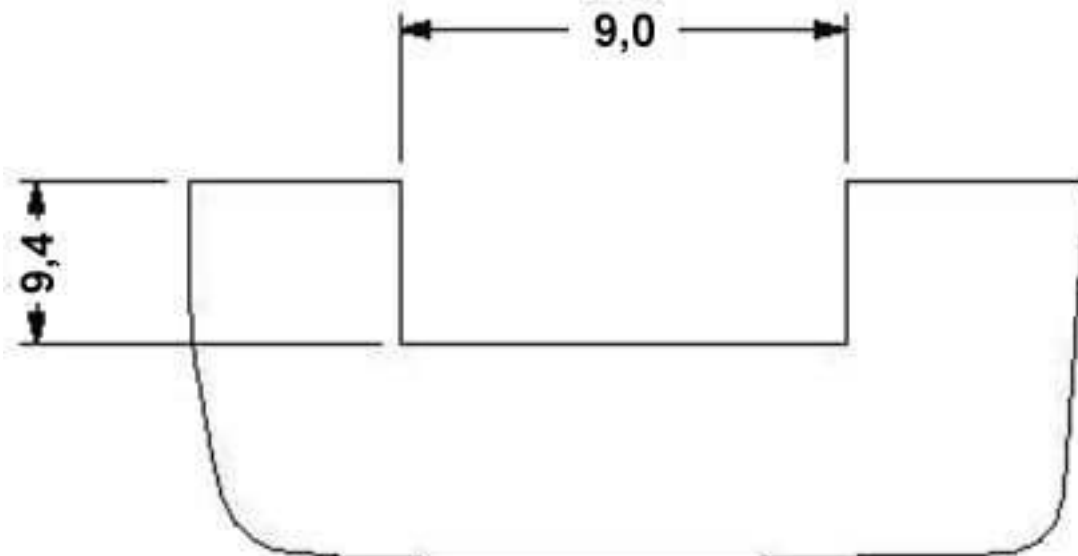

Housing cutout (panel thickness 1.7) for one transformer terminal block

Molded transformer terminal block - VTRK 4 GY - 3004605

Dimensioned drawing

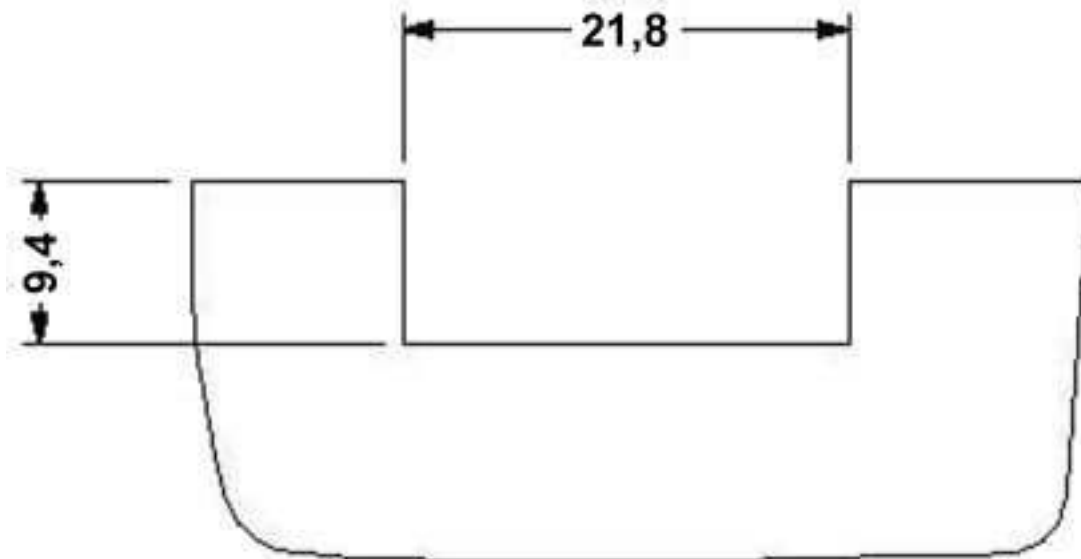

Housing cutout (panel thickness 1.7) for two transformer terminal blocks

Dimensioned drawing

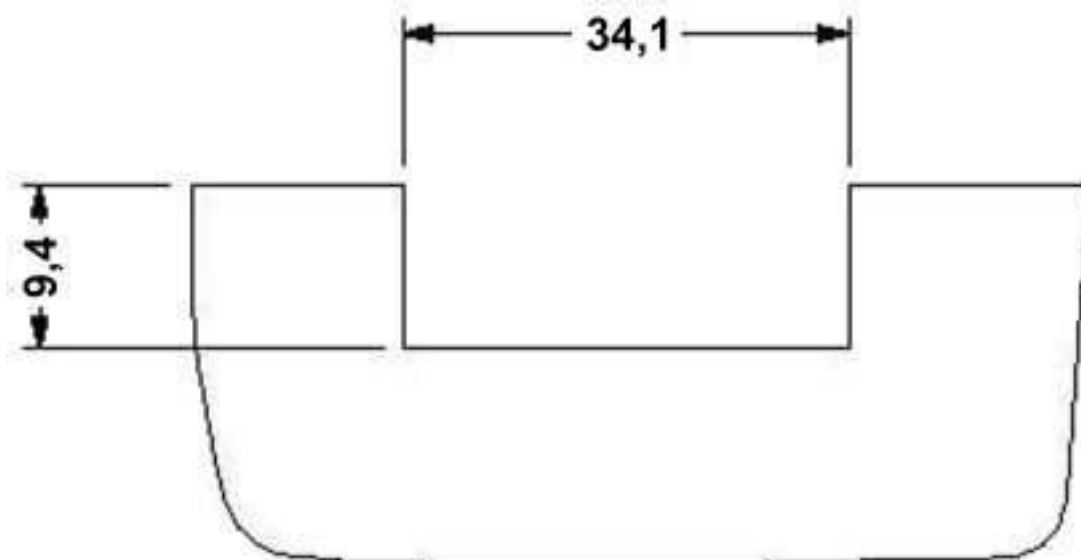

Housing cutout (panel thickness 1.7) for three transformer terminal blocks

Molded transformer terminal block - VTRK 4 GY - 3004605

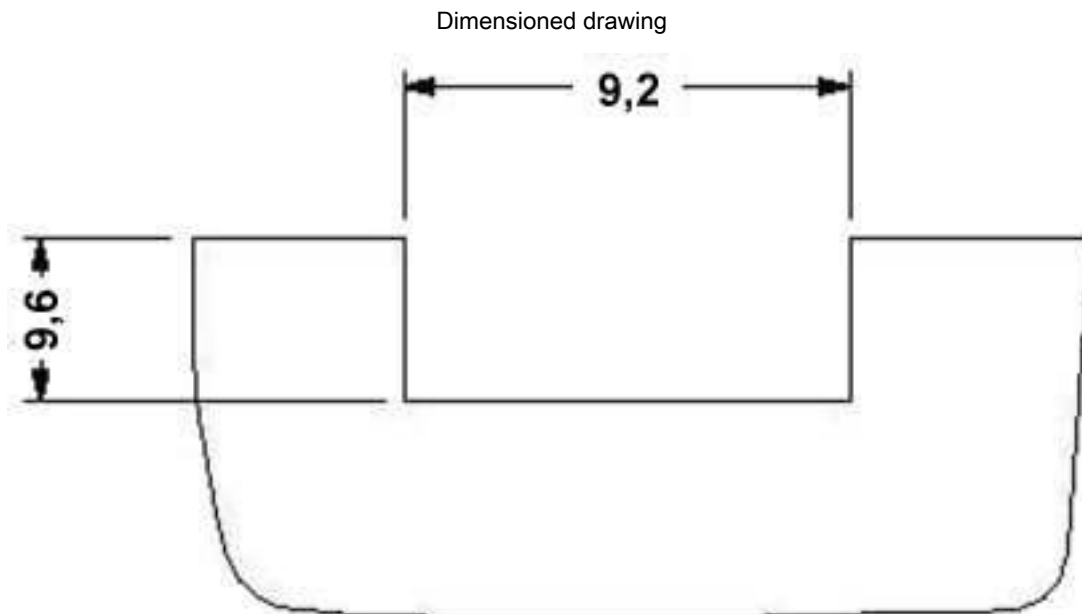

Housing cutout (panel thickness 1.8) for one transformer terminal block