

PKJ4716H Series DC/DC Converters
 Input 36-75 V, Output 14 A / 700 W

28701-BMR68103 Rev.B October 2019
 © Flex

Key Features

- Industry standard Half-brick
 61.0 x 57.9 x 12.7 mm (2.4 x 2.28 x 0.50 in)
- High efficiency, typ. 95.8% at 50Vout full load
- 1500 Vdc input to output isolation
- Meets safety requirements according to IEC/EN/UL 62368-1
- MTBF 6.7 Million hours



General Characteristics

- Output over voltage protection
- Input under voltage shutdown
- Over temperature protection
- Monotonic start-up
- Output short-circuit protection
- Remote sense
- Remote control
- Output voltage adjust function
- Highly automated manufacturing ensures quality
- ISO 9001/14001 certified supplier

Safety Approvals



Design for Environment



Meets requirements in high-temperature lead-free soldering processes.

Contents

Ordering Information	2
General Information	2
Safety Specification	3
Absolute Maximum Ratings	4
Electrical Specification	
50 V, 14 A / 700 W	PKJ4716H 5
EMC Specification	9
Operating Information	10
Thermal Consideration	12
Connections	13
Mechanical Information	14
Soldering Information	15
Delivery Information	15
Product Qualification Specification	16

PKJ4716H Series DC/DC Converters
Input 36-75 V, Output 14 A / 700 W

28701-BMR68103 Rev.B

October 2019

© Flex

Ordering Information

Product program	Output
PKJ4716H	50V, 14A / 700W

Product number and Packaging

PKJ4716Hn ₁ n ₂ n ₃ n ₄				
Options	n ₁	n ₂	n ₃	n ₄
Mounting	o			
Remote Control logic		o		
Mechanical Option			o	
Lead length				o

Options	Description
n ₁	PI Through hole
n ₂	Negative Logic * P Positive Logic
n ₃	HS Heat Sink
n ₄	5.30 mm * LA 3.69 mm

* Standard variant (i.e. no option selected).

General Information

Reliability

The failure rate (λ) and mean time between failures (MTBF = $1/\lambda$) is calculated at max output power and an operating ambient temperature (T_A) of +40°C. Flex Power Modules uses Telcordia SR-332 Issue 4 Method 1 to calculate the mean steady-state failure rate and standard deviation (σ).

Telcordia SR-332 Issue 4 also provides techniques to estimate the upper confidence levels of failure rates based on the mean and standard deviation.

Mean steady-state failure rate, λ	Std. deviation, σ
150 nFailures/h	8.1 nFailures/h

MTBF (mean value) for the PKJ4716A = 6.7 Mh.

MTBF at 90% confidence level = 6.2 Mh

Compatibility with RoHS requirements

The products are compatible with the relevant clauses and requirements of the RoHS directive 2011/65/EU and have a maximum concentration value of 0.1% by weight in homogeneous materials for lead, mercury, hexavalent chromium, PBB and PBDE and of 0.01% by weight in homogeneous materials for cadmium.

Exemptions in the RoHS directive utilized in Flex Power Modules products are found in the Statement of

Compliance document.

Flex Power Modules fulfills and will continuously fulfill all its obligations under regulation (EC) No 1907/2006 concerning the registration, evaluation, authorization and restriction of chemicals (REACH) as they enter into force and is through product materials declarations preparing for the obligations to communicate information on substances in the products.

Quality Statement

The products are designed and manufactured in an industrial environment where quality systems and methods like ISO 9000, Six Sigma, and SPC are intensively in use to boost the continuous improvements strategy. Infant mortality or early failures in the products are screened out and they are subjected to an ATE-based final test. Conservative design rules, design reviews and product qualifications, plus the high competence of an engaged work force, contribute to the high quality of the products.

Warranty

Warranty period and conditions are defined in Flex Power Modules General Terms and Conditions of Sale.

Limitation of Liability

Flex Power Modules does not make any other warranties, expressed or implied including any warranty of merchantability or fitness for a particular purpose (including, but not limited to, use in life support applications, where malfunctions of product can cause injury to a person's health or life).

© Flex 2019

The information and specifications in this technical specification is believed to be correct at the time of publication. However, no liability is accepted for inaccuracies, printing errors or for any consequences thereof. Flex reserves the right to change the contents of this technical specification at any time without prior notice.

PKJ4716H Series DC/DC Converters Input 36-75 V, Output 14 A / 700 W	28701-BMR68103 Rev.B	October 2019
	© Flex	

Safety Specification

General information

Flex Power DC/DC converters and DC/DC regulators are designed in accordance with the safety standards IEC 62368-1, EN 62368-1 and UL 62368-1 *Audio/video, information and communication technology equipment - Part 1: Safety requirements*

IEC/EN/UL 62368-1 contains requirements to prevent injury or damage due to the following hazards:

- Electrical shock
- Electrically-caused fire
- Injury caused by hazardous substances
- Mechanically-caused injury
- Skin burn
- Radiation-caused injury

On-board DC/DC converters, Power interface modules and DC/DC regulators are defined as component power supplies. As components they cannot fully comply with the provisions of any safety requirements without "conditions of acceptability". Clearance between conductors and between conductive parts of the component power supply and conductors on the board in the final product must meet the applicable safety requirements. Certain conditions of acceptability apply for component power supplies with limited stand-off (see Mechanical Information for further information). It is the responsibility of the installer to ensure that the final product housing these components complies with the requirements of all applicable safety standards and regulations for the final product.

Component power supplies for general use shall comply with the requirements in IEC/EN/UL 62368-1. Product related standards, e.g. IEEE 802.3af *Power over Ethernet*, and ETS-300132-2 *Power interface at the input to telecom equipment, operated by direct current (dc)* are based on IEC/EN/UL 62368-1 with regards to safety.

Flex Power DC/DC converters, Power interface modules and DC/DC regulators are UL 62368-1 recognized and certified in accordance with EN 62368-1. The flammability rating for all construction parts of the products meet requirements for V-0 class material according to IEC 60695-11-10, *Fire hazard testing, test flames – 50 W* horizontal and vertical flame test methods.

Isolated DC/DC converters & Power interface modules

The product may provide basic or functional insulation between input and output according to IEC/EN/UL 62368-1 (see Safety Certificate), different conditions shall be met if the output of a basic or a functional insulated product shall be considered as ES1 energy source.

For basic insulated products (see Safety Certificate) the output is considered as ES1 energy source if one of the following conditions is met:

- The input source provides supplementary or double or reinforced insulation from the AC mains according to IEC/EN/UL 62368-1.
- The input source provides functional or basic insulation from the AC mains and the product's output is reliably connected to protective earth according to IEC/EN/UL 62368-1.

For functional insulated products (see Safety Certificate) the output is considered as ES1 energy source if one of the following conditions is met:

- The input source provides double or reinforced insulation from the AC mains according to IEC/EN/UL 62368-1.
- The input source provides basic or supplementary insulation from the AC mains and the product's output is reliably connected to protective earth according to IEC/EN/UL 62368-1.
- The input source is reliably connected to protective earth and provides basic or supplementary insulation according to IEC/EN/UL 62368-1 and the maximum input source voltage is 60 Vdc.

Galvanic isolation between input and output is verified in an electric strength test and the isolation voltage (V_{iso}) meets the voltage strength requirement for basic insulation according to IEC/EN/UL 62368-1.

It is recommended to use a slow blow fuse at the input of each DC/DC converter. If an input filter is used in the circuit the fuse should be placed in front of the input filter. In the rare event of a component problem that imposes a short circuit on the input source, this fuse will provide the following functions:

- Isolate the fault from the input power source so as not to affect the operation of other parts of the system
- Protect the distribution wiring from excessive current and power loss thus preventing hazardous overheating

PKJ4716H Series DC/DC Converters
 Input 36-75 V, Output 14 A / 700 W

28701-BMR68103 Rev.B

October 2019

© Flex

Absolute Maximum Ratings

Characteristics		min	typ	max	Unit
T _A	Ambient Operating Temperature	-40		+100	°C
T _{PI1}	Operating Temperature (see Thermal Consideration section)	-40		+125	°C
T _{PI2}	Base plate Operating Temperature	-40		+100	°C
T _S	Storage temperature	-55		+125	°C
V _I	Input voltage	-0.5		+80	V
C _{in}	Input capacitance	470			μF
C _{out}	Output capacitance	1000		4400	μF
V _{iso}	Isolation voltage (input to output)			1500	Vdc
V _{iso}	Isolation voltage (input to baseplate)			750	Vdc
V _{iso}	Isolation voltage (baseplate to output)			750	Vdc
V _{tr}	Input voltage transient according to ETSI EN 300 132-2 and Telecordia GR-1089-CORE			100	V
V _{adj}	Adjust pin voltage (see Operating Information section)	-0.5		5	V
V _{RC}	Remote Control pin voltage (see Operating Information section)	Positive logic option		6	V
		Negative logic option	-0.5	6	V

Stresses above those listed under Absolute Maximum Ratings may cause permanent damage to the device. This is a stress rating only; functional operation of the device at these or any other conditions above those indicated in the Electrical Specification section of this specification is not implied. Exposure to absolute maximum rating conditions for extended periods may affect device reliability. Exposure to conditions outside normal operating can conditions may violate design rules and therefore also reliability.

Fundamental Circuit Diagram

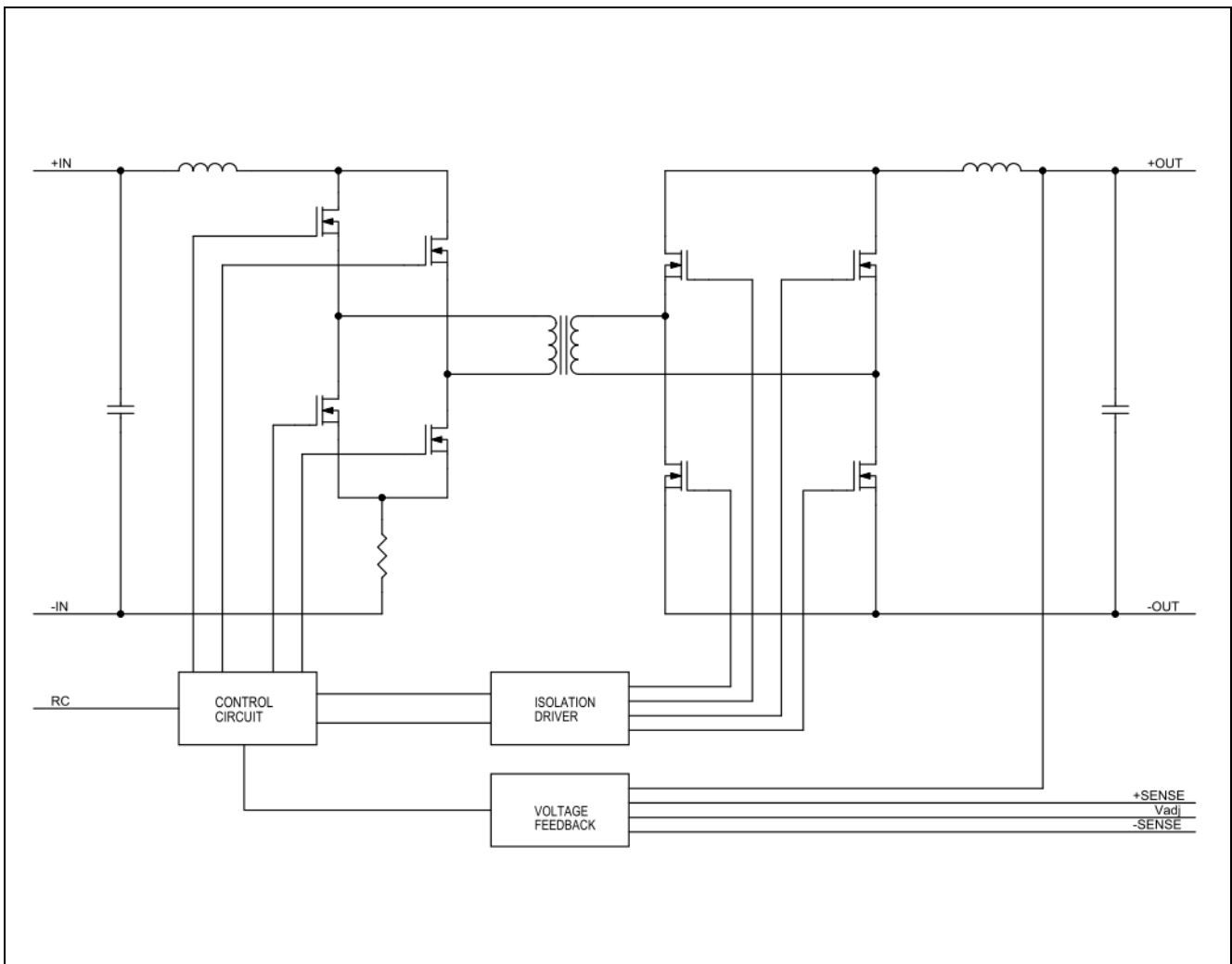

PKJ4716H Series DC/DC Converters
 Input 36-75 V, Output 14 A / 700 W

28701-BMR68103 Rev.B

October 2019

© Flex

Electrical Specification
50 V, 14 A / 700 W
PKJ4716HPIHS
 $T_{P1} = -40$ to $+100$ °C, $V_I = 36$ to 75 V, sense pins connected to output pins unless otherwise specified under Conditions.

 Typical values given at: $T_{P1} = +25$ °C, $V_I = 53$ V max I_O , unless otherwise specified under Conditions.

 Additional $C_{in} = 470$ µF, $C_{out} = 1360$ µF. See Operating Information section for selection of capacitor types.

Characteristics		Conditions	min	typ	max	Unit
V_I	Input voltage range		36		75	V
V_{loff}	Turn-off input voltage	Decreasing input voltage	29	31	33	V
V_{lon}	Turn-on input voltage	Increasing input voltage	31	33	35	V
C_I	Internal input capacitance			75		µF
P_O	Output power		0		700	W
η	Efficiency	50% of max I_O $V_I = 48$ V	94.5	95.7		%
		max I_O $V_I = 48$ V	94.5	95.8		
		50% of max I_O	93.3	95.3		
		max I_O	93.3	95.6		
	Power Dissipation	max I_O		32	50	W
P_{li}	Input idling power	$I_O = 0$ A		9.3		W
P_{RC}	Input standby power	(turned off with RC)		0.9		W
f_s	Switching frequency	0-100 % of max I_O	170	190	210	kHz

V_{Oi}	Output voltage initial setting and accuracy	$T_{P1} = +25$ °C, $V_I = 48$ V, $I_O = 0$ A	49	50	51	V
V_O	Output adjust range	See operating information	25		55	V
	Output voltage tolerance band	0-100% of max I_O	48.5		51.5	V
	Idling voltage	$I_O = 0$ A	48.5		51.5	V
	Line regulation	max I_O , $V_I = 36-75$ V		10	80	mV
	Load regulation	0-100% of max I_O		20	200	mV
V_{tr}	Load transient voltage deviation	Load step 25-75-25% of max I_O , $di/dt = 1$ A/µs		±300	±650	mV
t_{tr}	Load transient recovery time			300	500	µs
t_r	Ramp-up time (from 10-90% of V_{Oi})	0-100% of max I_O	60	70	80	ms
t_s	Start-up time (from V_I connection to 90% of V_{Oi})		120	130	140	ms
t_{RC}	RC start-up time (from V_{RC} connection to 90% of V_{Oi})	max I_O	120	130	140	ms
RC	Sink current	See operating information	0.02			mA
	Trigger level	Logic high voltage	2.3	2.7	6	V
		Logic low voltage	0	1.6	2	
I_O	Output current		0		14	A
I_{lim}	Current limit threshold	$T_{P1} < \max T_{P1}$	14.7	19	24.3	A
I_{sc}	Short circuit current	$T_{P1} = 25$ °C, see Note 1		9	12	A
C_{out}	Capacitive Load	$T_{P1} = 25$ °C	1000		4400	µF
V_{Oac}	Output ripple & noise	See ripple & noise section, V_{Oi}		60	150	mVp-p
OVP	Over voltage protection	$T_{P1} = +25$ °C, $V_I = 48$ V, 0-100% of max I_O	56	57.6	60	V
OTP	Over temperature protection	T_{p2}	100	110	120	°C
	OTP hysteresis		1	5		°C

Note 1: Hiccup mode OCP, RMS value

PKJ4716H Series DC/DC Converters
 Input 36-75 V, Output 14 A / 700 W

28701-BMR68103 Rev.B

October 2019

© Flex

Typical Characteristics
50 V, 14 A / 700 W

PKJ4716HPIHS

Efficiency

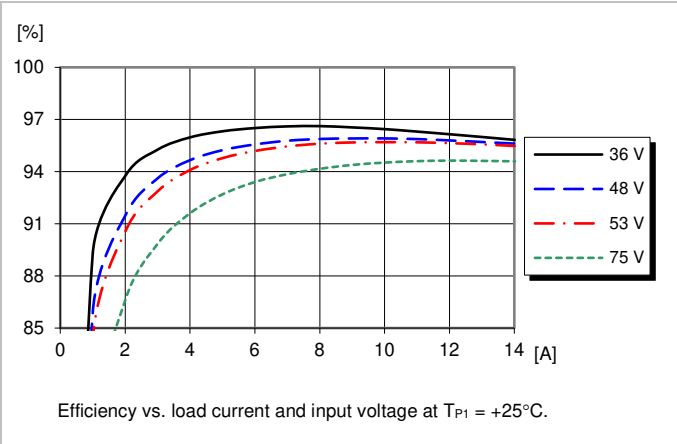

Power Dissipation

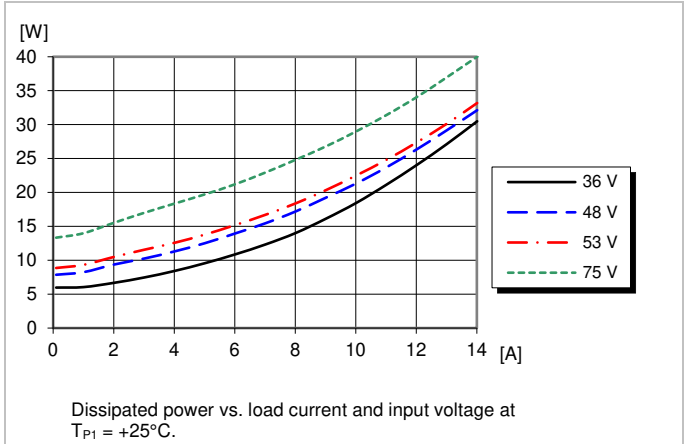

Output Characteristics

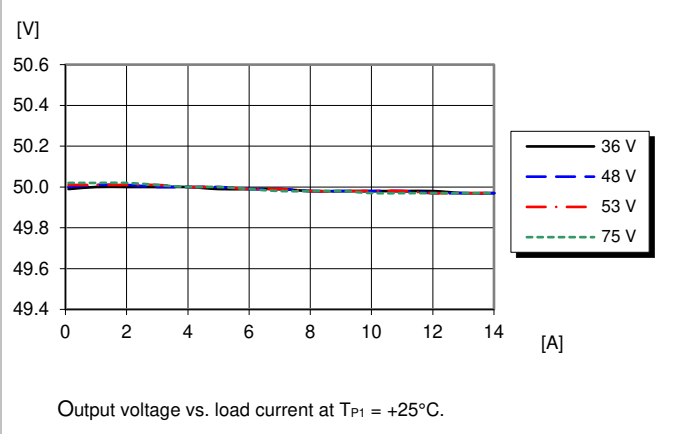

Output Characteristics

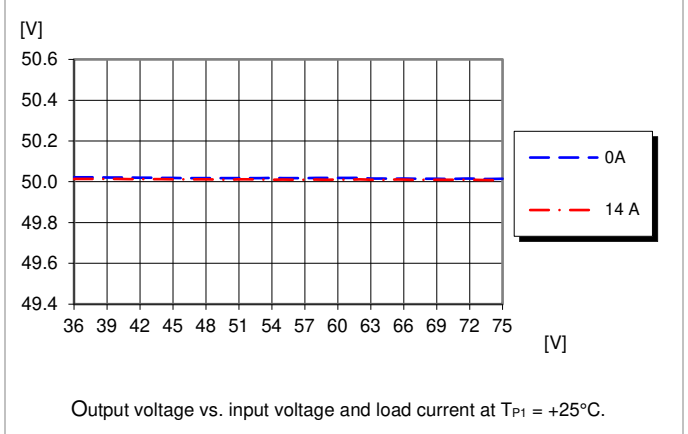

Current Limit Characteristics

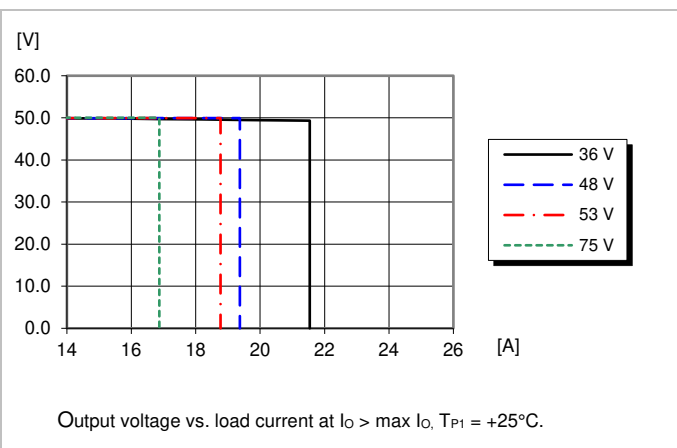

Max adjustable output voltage

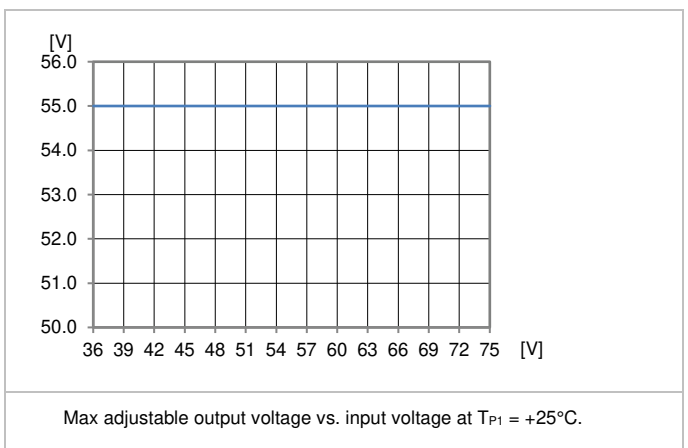

PKJ4716H Series DC/DC Converters

Input 36-75 V, Output 14 A / 700 W

28701-BMR68103 Rev.B

October 2019

© Flex

Typical Characteristics

50 V, 14 A / 700 W

PKJ4716HPIHS

Start-up

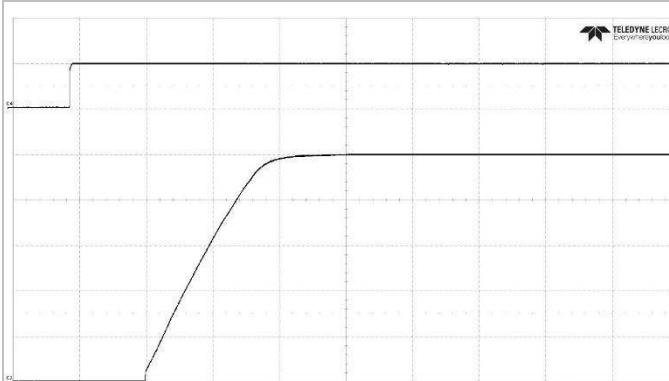

Start-up enabled by connecting V₁ at:
T_{P1} = +25°C, V₁ = 48 V,
I_o = 0.28S resistive load.

Top trace: input voltage (50 V/div.).
Bottom trace: output voltage (10 V/div.).
Time scale: (50 ms/div.).

Shut-down

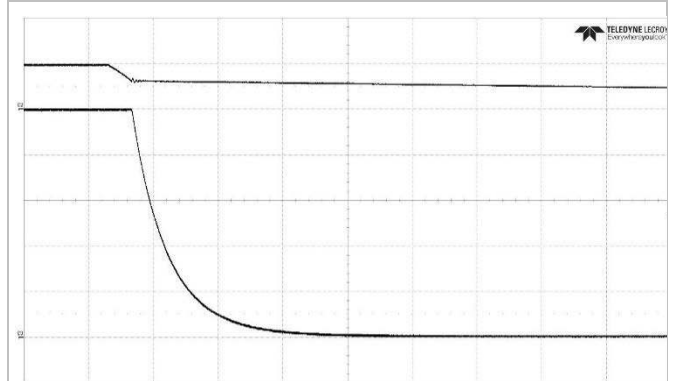

Shut-down enabled by disconnecting V₁ at:
T_{P1} = +25°C, V₁ = 48 V,
I_o = 0.25S resistive load.

Top trace: input voltage (50 V/div.).
Bottom trace: output voltage (10 V/div.).
Time scale: (10 ms/div.).

Output Ripple & Noise

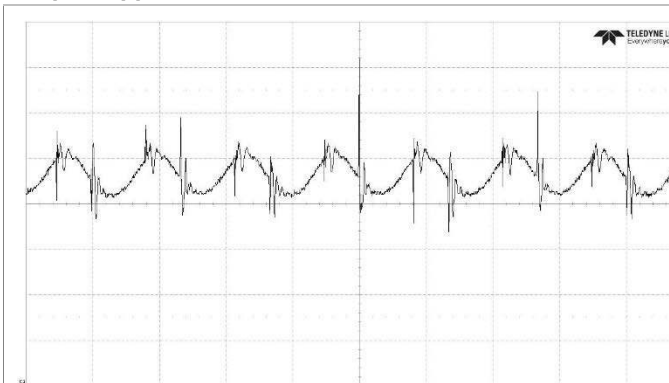

Output voltage ripple at:
T_{P1} = +25°C, V₁ = 48 V,
I_o = 0.25S resistive load.

Trace: output voltage (100 mV/div.).
Time scale: (2 μs/div.).

Output Load Transient Response

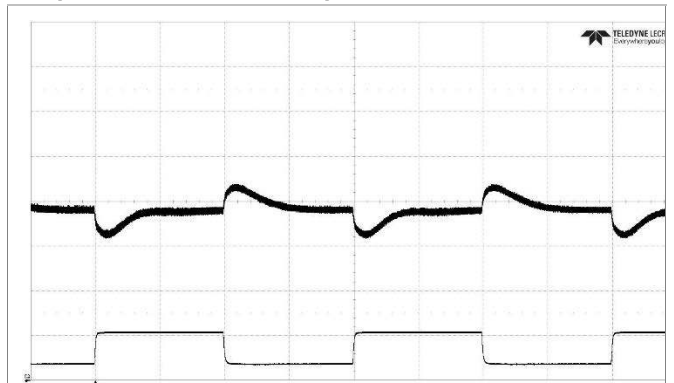

Output voltage response to load current step change (3.5-10.5-3.5 A) at:
T_{P1} = +25°C, V₁ = 48 V.

Top trace: output voltage (500 mV/div.).
Bottom trace: load current (10 A/div.).
Time scale: (0.5 ms/div.).

Output Voltage Adjust (see operating information)

Passive adjust

The resistor value for an adjusted output voltage is calculated by using the following equations:

Output Voltage Adjust, Decrease:

$$R_{adj} = \left(\frac{100}{\Delta\%} - 2 \right) \text{ k}\Omega$$

Output Voltage Adjust, Increase:

$$R_{adj} = \left(\frac{50 \times (100 + \Delta\%)}{1.225 \times \Delta\%} - \frac{100}{\Delta\%} - 2 \right) \text{ k}\Omega$$

Example: Increase 10% => V_o = 55 Vdc

$$\left(\frac{50 \times (100 + 10)}{1.225 \times 10} - \frac{100}{10} - 2 \right) \text{ k}\Omega = 437 \text{ k}\Omega$$

Active adjust

The output voltage can be adjusted using a voltage applied to the V_{adj} pin, R_{adj} is in kOhm. This voltage is calculated by using the following equation:

$$V_{adj} = \left(1.225 + (R_{adj} + 2) \times 1.225 \times \frac{V_{desired} - 50}{50} \right)$$

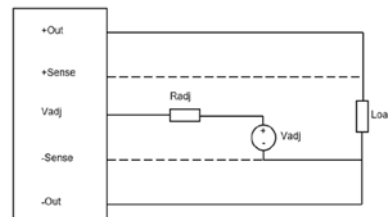

PKJ4716H Series DC/DC Converters
 Input 36-75 V, Output 14 A / 700 W

28701-BMR68103 Rev.B

October 2019

© Flex

Typical Characteristics
50 V, 14 A / 700 W

PKJ4716HPIHS

Output Current Derating – Cold wall sealed box

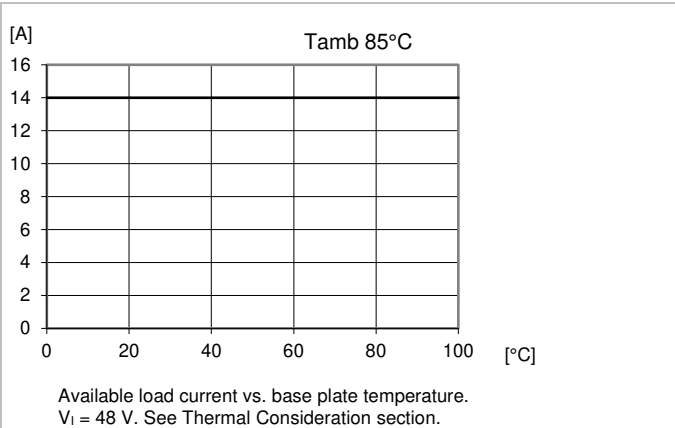

PKJ4716H Series DC/DC Converters
 Input 36-75 V, Output 14 A / 700 W

28701-BMR68103 Rev.B

October 2019

© Flex

EMC Specification

Conducted EMI measured according to EN55032, CISPR 32 and FCC part 15J (see test set-up). See Design Note 009 for further information. The fundamental switching frequency is 190 kHz for PKJ4716HPIHS at $V_i = 48\text{ V}$ and max I_o .

Conducted EMI Input terminal value (typ)

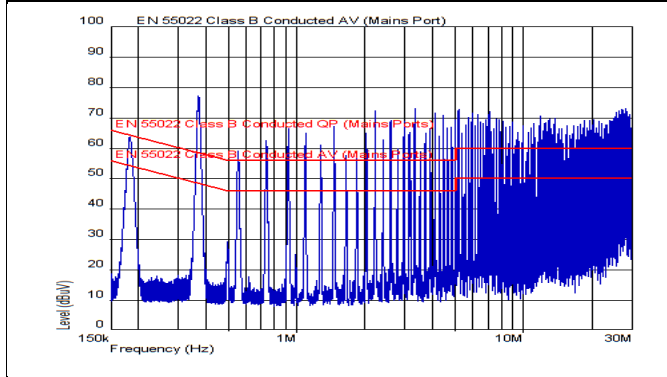

EMI without filter (pre-scan, peak detector results)

Optional external filter for class B

Suggested external input filter in order to meet class B in EN 55022, CISPR 22 and FCC part 15J. The increased input capacitance ensures stable operation at min V_{in} with recommended CM- chokes.

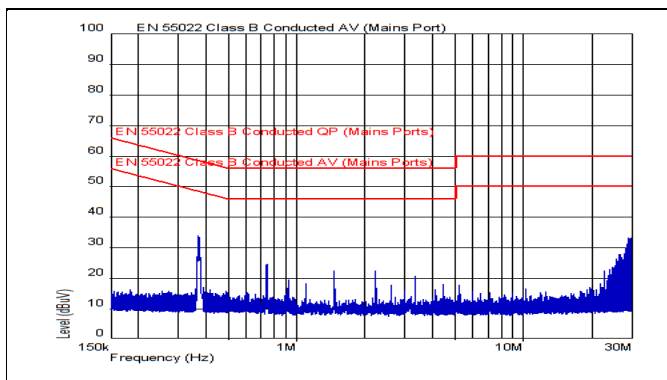
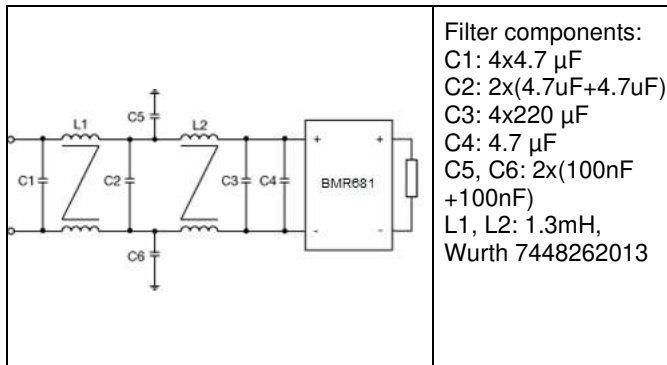

EMI with filter (pre-scan, peak detector results)

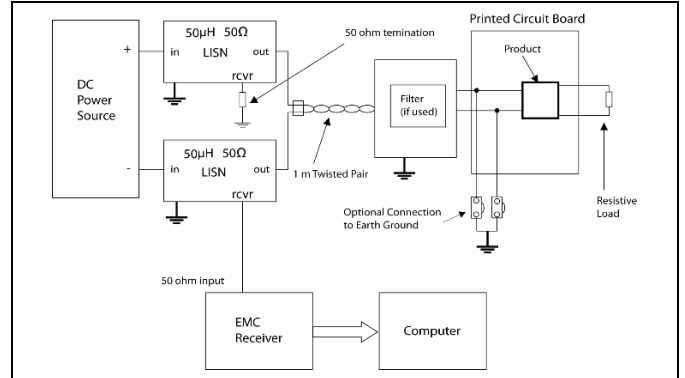

Test set-up

Layout recommendations

The radiated EMI performance of the product will depend on the PWB layout and ground layer design. It is also important to consider the stand-off of the product. If a ground layer is used, it should be connected to the output of the product and the equipment ground or chassis.

A ground layer will increase the stray capacitance in the PWB and improve the high frequency EMC performance.

The product includes positions for capacitors that internally connect the base plate to the power pins, please contact your local Flex sales contact for further info as this is not included in the standard variant.

Output ripple and noise

Output ripple and noise measured according to figure below. See Design Note 022 for detailed information.

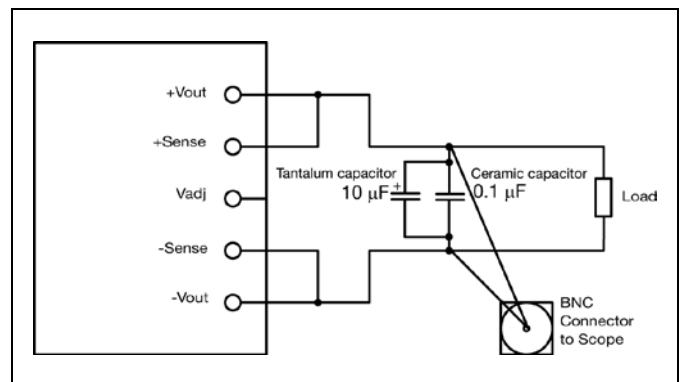

Output ripple and noise test setup

PKJ4716H Series DC/DC Converters
Input 36-75 V, Output 14 A / 700 W

28701-BMR68103 Rev.B

October 2019

© Flex

Operating information

Input Voltage

The input voltage range 36 to 75 Vdc meets the requirements of the European Telecom Standard ETS 300 132-2 for normal input voltage range in -48 and -60 Vdc systems, -40.5 to -57.0 V and -50.0 to -72 V respectively.

At input voltages exceeding 75 V, the power loss will be higher than at normal input voltage and T_{P1} must be limited to absolute max +125 °C. The absolute maximum continuous input voltage is 80 Vdc.

Short duration transient disturbances can occur on the DC distribution and input of the product when a short circuit fault occurs on the equipment side of a protective device (fuse or circuit breaker). The voltage level, duration and energy of the disturbance are dependent on the particular DC distribution network characteristics and can be sufficient to damage the product unless measures are taken to suppress or absorb this energy. The transient voltage can be limited by capacitors and other energy absorbing devices like TVS diode connected across the positive and negative input conductors at a number of strategic points in the distribution network. The end-user must secure that the transient voltage will not exceed the value stated in the Absolute maximum ratings. ETSI TR 100 283 examines the parameters of DC distribution networks and provides guidelines for controlling the transient and reduce its harmful effect.

Turn-off Input Voltage

The products monitor the input voltage and will turn on and turn off at predetermined levels.

The minimum hysteresis between turn on and turn off input voltage is 1 V.

Remote Control (RC)

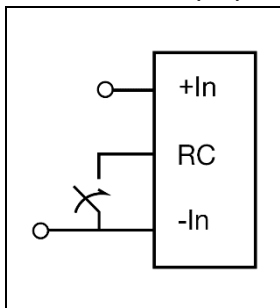

The products are fitted with a remote control function referenced to the primary negative input connection (-In), with negative and positive logic options available. The RC function allows the product to be turned on/off by an external device like a semiconductor or mechanical switch. The RC pin has an internal pull up resistor to +5V.

The external device must provide a minimum required sink current to guarantee a voltage not higher than maximum voltage on the RC pin (see Electrical characteristics table). When the RC pin is left open, the voltage generated on the RC pin is 5 V.

The standard product is provided with “positive logic” RC and will be off until the RC pin is released from the -In. To turn off the product the RC pin should be connected to -In, or connected to a voltage less than 2 V referenced to -In. In

situations where it is desired to have the product to power up automatically without the need for control signals or a switch, the RC pin can be left floating.

The second option is “negative logic” remote control, which can be ordered by adding the suffix “N” to the end of the part number. When the RC pin is connected to -In, the product starts up automatically when the input voltage is applied. Turn off is achieved by disconnecting the RC pin from the -In, or connected to a voltage higher than 2.3V. The product will restart automatically when this connection is connected to -In.

See Design Note 021 for detailed information.

Input and Output Impedance

The impedance of both the input source and the load will interact with the impedance of the product. It is important that the input source has low characteristic impedance. The performance in some applications can be enhanced by addition of external capacitance as described under External Decoupling Capacitors.

If the input voltage source contains significant inductance, the value of the external input capacitor must be increased to ensure stable operation at low input voltage. The added capacitance is not required when powering the product from an input source with an inductance below 10 μ H. The minimum required capacitance value depends on the output power and the input voltage. The higher output power the higher input capacitance is needed. Approximately doubled capacitance value is required for a 24 V input voltage source compared to a 48 V input voltage source.

External Decoupling Capacitors

When powering loads with significant dynamic current requirements, the voltage regulation at the point of load can be improved by addition of decoupling capacitors at the load. The most effective technique is to locate low ESR ceramic and electrolytic capacitors as close to the load as possible, using several parallel capacitors to lower the effective ESR. The ceramic capacitors will handle high-frequency dynamic load changes while the electrolytic capacitors are used to handle low frequency dynamic load changes. It is equally important to use low resistance and low inductance PWB layouts and cabling.

External decoupling capacitors will become part of the product's control loop. The control loop is optimized for a wide range of external capacitance and the maximum recommended value that could be used without any additional analysis is found in the Electrical specification.

The ESR of the capacitors is a very important parameter. Stable operation is guaranteed with a verified ESR value of >10 m Ω across the output connections.

For further information please contact your local Flex Power Modules representative.

Output Voltage Adjust (V_{adj})

PKJ4716H Series DC/DC Converters

Input 36-75 V, Output 14 A / 700 W

28701-BMR68103 Rev.B

October 2019

© Flex

The products have an Output Voltage Adjust pin (V_{adj}). This pin can be used to adjust the output voltage above or below Output voltage initial setting.

When increasing the output voltage, the voltage at the output pins (including any remote sense compensation) must be kept below the threshold of the over voltage protection, (OVP) to prevent the product from shutting down. At increased output voltages the maximum power rating of the product remains the same, and the max output current must be decreased correspondingly.

Output Voltage Adjust (V_{adj})

It is possible to change output voltage either by using passive components or active (dependent current source). If using a resistor to increase the voltage the resistor should be connected between the V_{adj} pin and +Sense pin. The resistor value of the Output voltage adjust function is according to information given under the Output section for the respective product.

To decrease the output voltage, the resistor should be connected between the V_{adj} pin and -Sense pin.

For active control and trim resistor values, please refer to the Typical characteristics section.

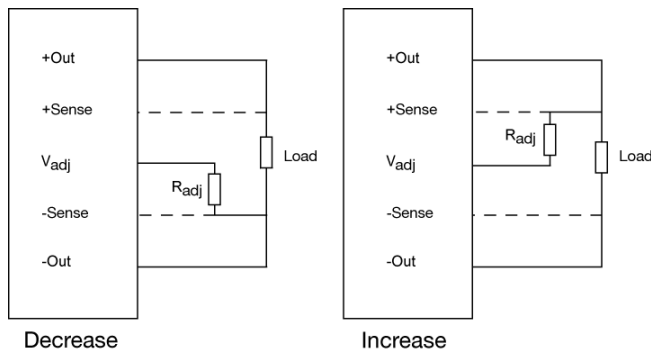

The products are protected from thermal overload by an internal over temperature shutdown circuit.

The product will make continuous attempts to start up (non-latching mode) and resume normal operation automatically when the temperature drops below the temperature threshold.

Over Voltage Protection (OVP)

The products have output over voltage protection that will shut down the product in over voltage conditions. The product will make continuous attempts to start up (non-latching mode) and resume normal operation automatically after removal of the over voltage condition.

Over Current Protection (OCP)

The products include current limiting circuitry for protection at continuous overload. The output voltage will decrease towards zero for output currents in excess of max output current (I_{Omax}). The product will resume normal operation after removal of the overload. The load distribution should be designed for the maximum output short circuit current specified.

Pre-bias Start-up

The product has a Pre-bias start up functionality and will not sink current during start up if a pre-bias source is present at the output terminals. The module will enable pre-biased starts when V_{out} is 4% less than target; e.g. if V_{out} is set to be 50 V restart is possible once V_{out} descend below 48V. This is internally controlled by the module.

Parallel Operation

Two products may be paralleled for redundancy if the total power is equal or less than P_{Omax} . It is not recommended to parallel the products without using external current sharing circuits.

See Design Note 006 for detailed information.

Remote Sense

The products have remote sense that can be used to compensate for voltage drops between the output and the point of load. The sense traces should be located close to the PWB ground layer to reduce noise susceptibility. The remote sense circuitry will compensate for up to 10% voltage drop between output pins and the point of load.

If the remote sense is not needed +Sense should be connected to +Out and -Sense should be connected to -Out.

Over Temperature Protection (OTP)

PKJ4716H Series DC/DC Converters
 Input 36-75 V, Output 14 A / 700 W

28701-BMR68103 Rev.B

October 2019

© Flex

Thermal Consideration

General

The products are designed to operate in different thermal environments and sufficient cooling must be provided to ensure reliable operation.

For products mounted on a PWB without a heat sink attached, cooling is achieved mainly by conduction, from the pins to the host board, and convection, which is dependent on the airflow across the product. Increased airflow enhances the cooling of the product.

The product is tested on a 254 x 254 mm, 35 μm (1 oz), 16-layer test board.

For products with base plate used in a sealed box/cold wall application, cooling is achieved mainly by conduction through the cold wall. The Output Current Derating graphs are found in the Output section for each model. The product is tested in a sealed box test set up with ambient temperatures 85 °C. See Design Note 028 for further details.

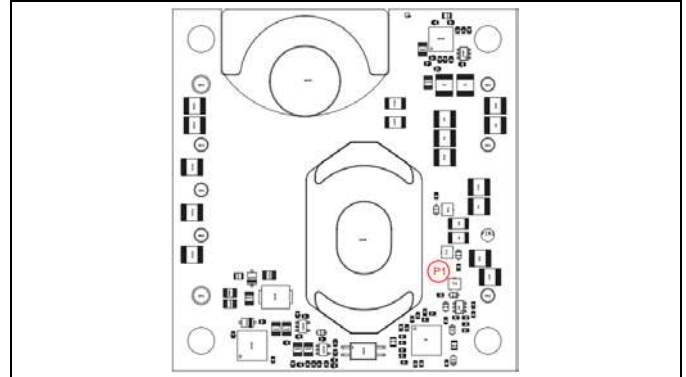

Reference point on pin side

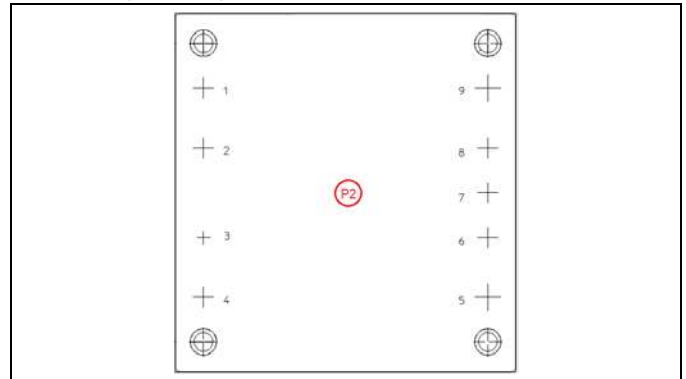

Reference point on baseplate side

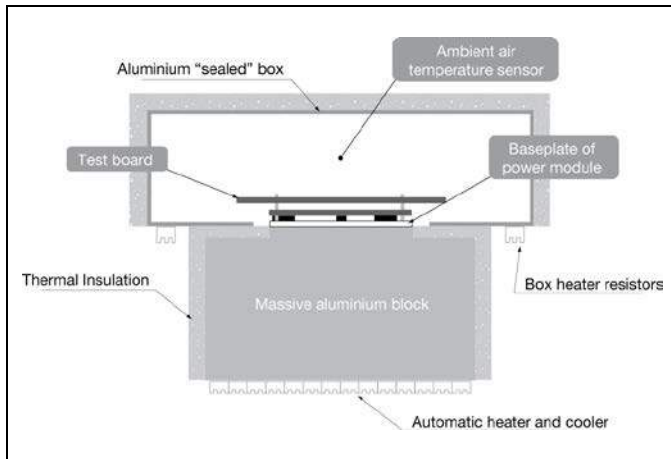

Definition of product operating temperature

The product operating temperatures is used to monitor the temperature of the product, and proper thermal conditions can be verified by measuring the temperature at positions P1 and P2. The temperature at these positions (T_{P1}, T_{P2}) should not exceed the maximum temperatures in the table below. The number of measurement points may vary with different thermal design and topology. Temperatures above maximum T_{P1}, measured at the reference point P1 are not allowed and may cause permanent damage.

Position	Description	Max Temp.
P1	PCB primary	T _{P1} =125° C
P2	Base plate	T _{P2} =100° C

Ambient Temperature Calculation

For products with base plate the maximum allowed ambient temperature can be calculated by using the thermal resistance.

- The power loss is calculated by using the formula $((1/\eta) - 1) \times \text{output power} = \text{power losses } (P_d)$.
 η = efficiency of product. E.g. 89.5% = 0.895
- Find the thermal resistance (R_{th}) in the Thermal Resistance graph found in the Output section for each model. **Note that the thermal resistance can be significantly reduced if a heat sink is mounted on the top of the base plate.**
- Calculate the temperature increase (ΔT).
 $\Delta T = R_{th} \times P_d$
- Max allowed ambient temperature is:
 Max T_{P1} - ΔT.
- The thermal performance can be significantly improved by mounting a heat sink on top of the base plate.

The thermal resistance between base plate and heat sink, R_{th, b-h} is calculated as:

PKJ4716H Series DC/DC Converters
 Input 36-75 V, Output 14 A / 700 W

28701-BMR68103 Rev.B

October 2019

© Flex

$$R_{th, b-h} = \frac{T_{base\ plate} - T_{heat\ sink}}{P_{loss}}$$

The actual temperature will be dependent on several factors such as the PWB size, number of layers and direction of airflow.

Connections

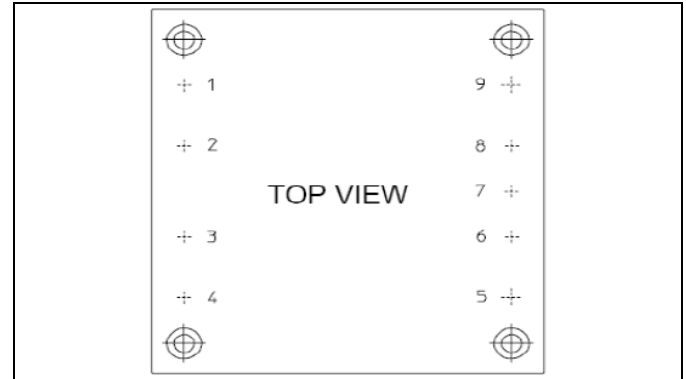

Pin	Designation	Function
1	+In	Positive input
2	RC	Remote control
3	NC	Connect to the baseplate
4	-In	Negative input
5	-Out	Negative output
6	-Sense	Negative remote sense
7	V _{adj}	Output voltage adjust
8	+Sense	Positive remote sense
9	+Out	Positive output

PKJ4716H Series DC/DC Converters
 Input 36-75 V, Output 14 A / 700 W

28701-BMR68103 Rev.B

October 2019

© Flex

Mechanical Information - Hole Mount, Base Plate Version

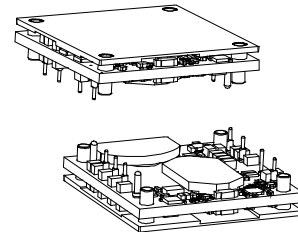
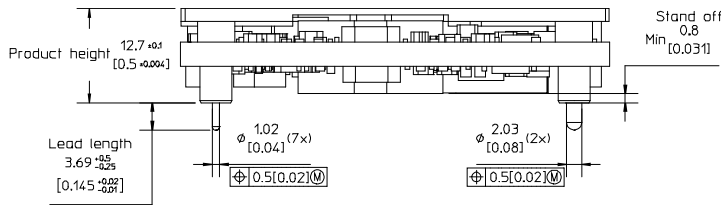

TOP VIEW

Pin positions according to recommended footprint

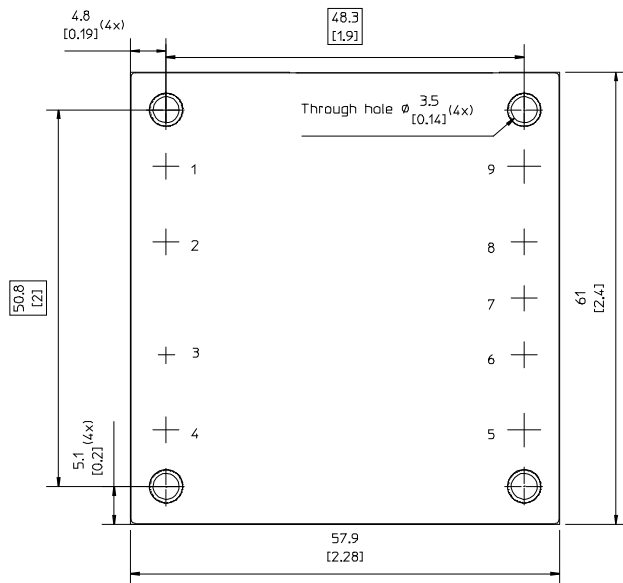

RECOMMENDED FOOTPRINT - TOP VIEW

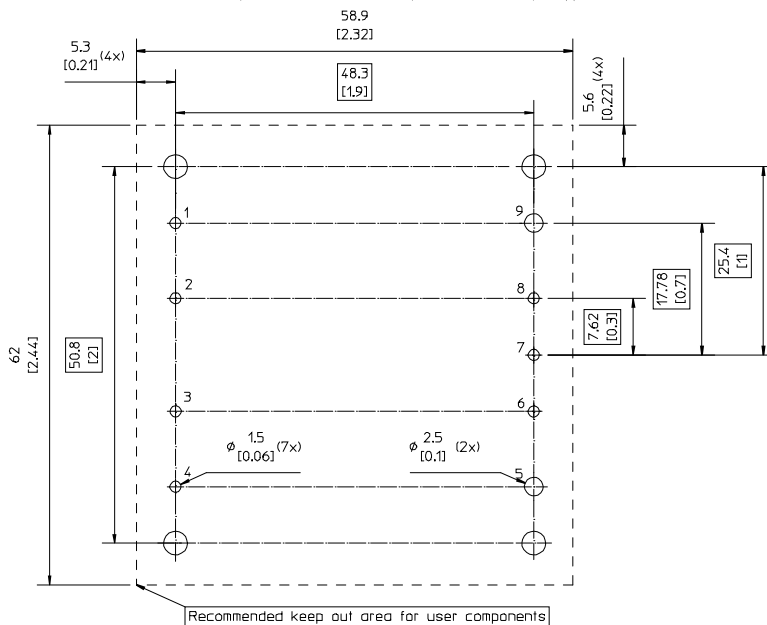
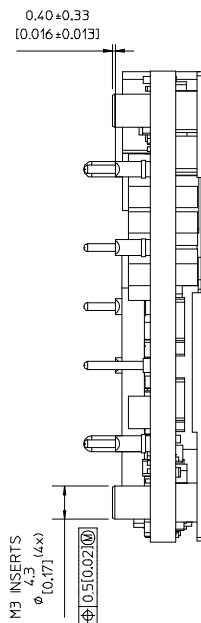

CASE:
 Material: Aluminium
 For screw attachment apply mounting torque of max 0.7Nm [3.9 lbf in].

Pins:
 Pins Material: Copper alloy
 Plating: Min Au 0.1 µm over 1-3 µm Ni.

Weight: Typical 113.1 g
 All dimensions in mm [inch]
 Tolerances unless specified:
 x.x ±0.5 mm [0.02],
 x.xx±0.25 mm [0.01]
 (not applied on footprint or typical values)



PKJ4716H Series DC/DC Converters
 Input 36-75 V, Output 14 A / 700 W

28701-BMR68103 Rev.B

October 2019

© Flex

Soldering Information - Hole Mounting

The hole mounted product is intended for plated through hole mounting by wave or manual soldering. The pin temperature is specified to maximum to 270°C for maximum 10 seconds.

A maximum preheat rate of 4°C/s and maximum preheat temperature of 150°C is suggested. When soldering by hand, care should be taken to avoid direct contact between the hot soldering iron tip and the pins for more than a few seconds in order to prevent overheating.

A no-clean flux is recommended to avoid entrapment of cleaning fluids in cavities inside the product or between the product and the host board. The cleaning residues may affect long time reliability and isolation voltage.

Delivery Package Information

The products are delivered in antistatic trays.

Tray Specifications	
Material	Antistatic PE Foam
Surface resistance	$10^5 < \text{Ohm/square} < 10^{11}$
Bakability	The trays are not bakable
Box capacity	30 products (3 full tray/box)
Tray weight	Product – Baseplate Version 140 g empty, 1270 g full tray

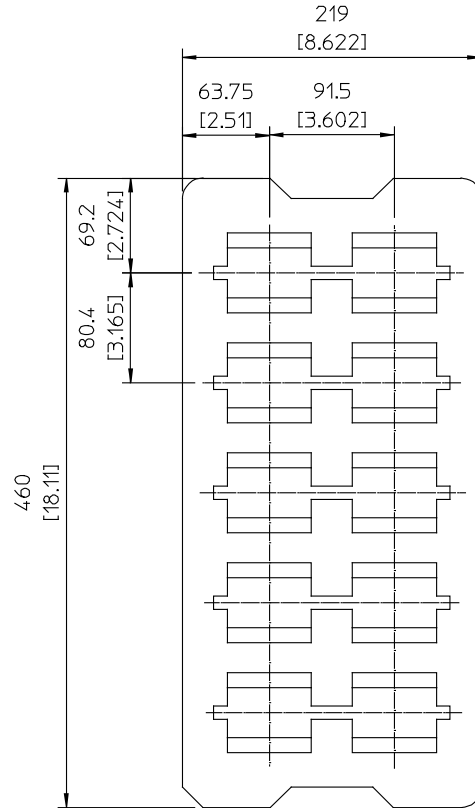

PKJ4716H Series DC/DC Converters
 Input 36-75 V, Output 14 A / 700 W

28701-BMR68103 Rev.B

October 2019

© Flex

Product Qualification Specification

Characteristics			
External visual inspection	IPC-A-610		
Change of temperature (Temperature cycling)	IEC 60068-2-14 Na	Temperature range Number of cycles Dwell/transfer time	-40 to 100°C 1000 15 min/0-1 min
Cold (in operation)	IEC 60068-2-1 Ad	Temperature T _A Duration	-45°C 72 h
Damp heat	IEC 60068-2-67 Cy	Temperature Humidity Duration	85°C 85 % RH 1000 hours
Dry heat	IEC 60068-2-2 Bd	Temperature Duration	125°C 1000 h
Electrostatic discharge susceptibility	IEC 61340-3-1, JESD 22-A114 IEC 61340-3-2, JESD 22-A115	Human body model (HBM) Machine Model (MM)	Class 2, 2000 V Class 3, 200 V
Immersion in cleaning solvents	IEC 60068-2-45 XA, method 2	Water Glycol ether	55°C 35°C
Mechanical shock	IEC 60068-2-27 Ea	Peak acceleration Duration	100 g 6 ms
Operational life test	MIL-STD-202G, method 108A	Duration	1000 h
Resistance to soldering heat ²	IEC 60068-2-20 Tb, method 1A	Solder temperature Duration	270°C 10-13 s
Robustness of terminations	IEC 60068-2-21 Test Ua1 IEC 60068-2-21 Test Ue1	Through hole mount products Surface mount products	All leads All leads
Solderability	IEC 60068-2-58 test Td ¹	Preconditioning Temperature, SnPb Eutectic Temperature, Pb-free	150°C dry bake 16 h 215°C 235°C
	IEC 60068-2-20 test Ta ²	Preconditioning Temperature, SnPb Eutectic Temperature, Pb-free	Steam ageing 235°C 245°C
Vibration, broad band random	IEC 60068-2-64 Fh, method 1	Frequency Spectral density Duration	10 to 500 Hz 0.07 g ² /Hz 10 min in each direction

Notes

¹ Only for products intended for reflow soldering

² Only for products intended for wave soldering