

6

5

4

3

2

1

APPROVED: \_\_\_\_\_

DATE: \_\_\_\_\_ TITLE: \_\_\_\_\_

Rev	AWO #	Description	Date	Appr
-		RELEASED	6/8/22	
A		ADDED PACKING	6/16/22	JJ/JL

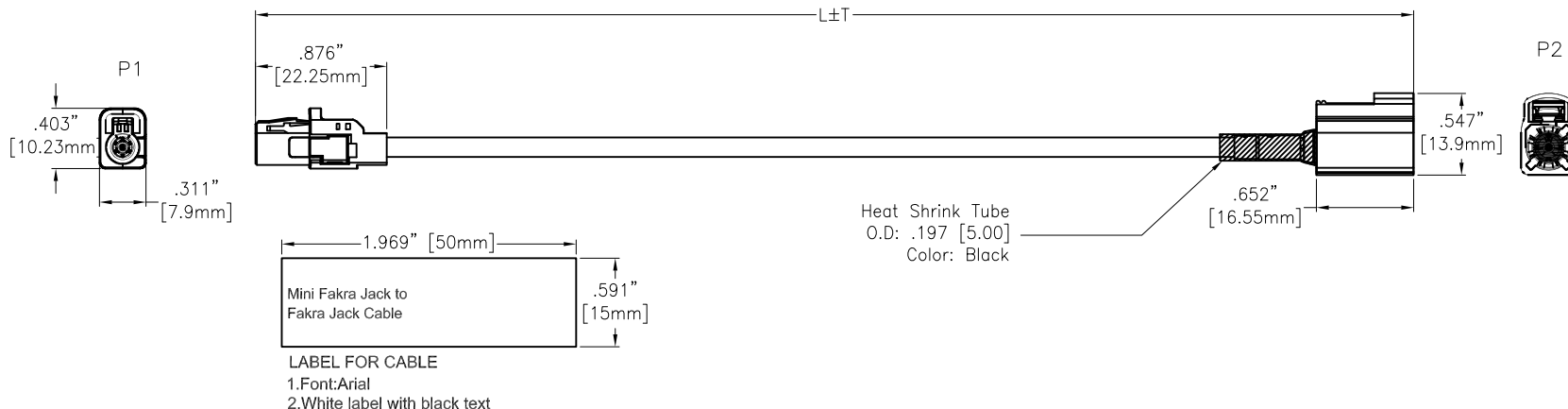

**SPECIFICATIONS:**

**Connector:**

P1= Mini FAKRA Code see Page 2, Jack, Straight, Type A, 30u" Gold Plated, UL94-V0

P2= FAKRA Code see Page 3, Jack, Straight, 30u" Gold Plated, UL94-V0

**Cable:**

Cable Coaxial+AL+Braid, O.D: .130" [3.3mm], Jacket Color: Black

**Electrical:**

Impedance: 50 Ohm

Temperature Rating:

-40°C to +105°C

**Electrical Test:**

All Assemblies must be 100% Tested for Shorts, Open, Continuity, and Physical Appearance.

**Environmental:**

Lead free, RoHS compliant



ADAM P/N	L+T
CA-AM01XJ-1FJX-1M	39.370"±1.181" [1000±30mm]
CA-AM01XJ-1FJX-1.9M	74.803"±1.181" [1900±30mm]
CA-AM01XJ-1FJX-2.5M	98.425"±1.969" [2500±50mm]

UNLESS OTHERWISE SPECIFIED ALL DIMENSIONS ARE INCHES [MM]. TOLERANCES: EXCEPT AS NOTED			<p>909 Rahway Avenue, Union, NJ 07083 Phone: 908-687-5000 Fax: 908-687-5710</p>											
<table border="1"> <thead> <tr> <th>INCHES</th> <th colspan="2">HOLES</th> </tr> </thead> <tbody> <tr> <td>.X ±.10</td> <td>Ø.X</td> <td>±.10</td> </tr> <tr> <td>.XX ±.020</td> <td>Ø.XX</td> <td>±.015</td> </tr> <tr> <td>.XXX ±.015</td> <td>Ø.XXX</td> <td>±.010</td> </tr> </tbody> </table>					INCHES	HOLES		.X ±.10	Ø.X	±.10	.XX ±.020	Ø.XX	±.015	.XXX ±.015
INCHES	HOLES													
.X ±.10	Ø.X	±.10												
.XX ±.020	Ø.XX	±.015												
.XXX ±.015	Ø.XXX	±.010												
DRAWN	WX	6/8/22	<b>TITLE</b> MINI FAKRA JACK A TYPE STRAIGHT TO FAKRA JACK STRAIGHT, OD 3.3 CABLE											
CHECKED	JL	6/8/22												
APPROVED														
THIS DRAWING CONTAINS INFORMATION THAT IS PROPRIETARY AND SHOULD NOT BE USED WITHOUT PRIOR WRITTEN PERMISSION FROM ADAM TECH			<table border="1"> <tr> <td>SIZE</td> <td>PART NO.</td> <td>REV.</td> </tr> <tr> <td>X</td> <td>CA-AM01XJ-1FJX-XM</td> <td>A</td> </tr> </table>	SIZE	PART NO.	REV.	X	CA-AM01XJ-1FJX-XM	A					
SIZE	PART NO.	REV.												
X	CA-AM01XJ-1FJX-XM	A												
REF: S00013T			SCALE: NTS	SHEET 1 OF 4										

6

5

4

3

2

1

6

5

4

3

2

1

APPROVED: \_\_\_\_\_

DATE: \_\_\_\_\_ TITLE: \_\_\_\_\_

Rev	AWO #	Description	Date	Appr
-----	-------	-------------	------	------

SEE SHT 1 OF 4 FOR REVISION

Mini Fakra A CA-AM01XJ-1FJX-XM

CODING A	CODING B	CODING C	CODING D	CODING E	CODING F	CODING G	CODING H
Black	White	Blue	Claret Violet	Green	Brown	Grey	Light Pink
CODING J	CODING K	CODING Z	All Coding				
Belge	Curry	Water Blue					

UNLESS OTHERWISE SPECIFIED ALL DIMENSIONS ARE INCHES [MM]. TOLERANCES: EXCEPT AS NOTED

INCHES		HOLES	
.X	±.10	Ø.X	±.10
.XX	±.020	Ø.XX	±.015
.XXX	±.015	Ø.XXX	±.010

**ADAM TECH**

909 Rahway Avenue,  
Union, NJ 07083  
Phone: 908-687-5000  
Fax: 908-687-5710

DRAWN	WX	6/8/22
CHECKED	JL	6/8/22
APPROVED		

TITLE  
MINI FAKRA JACK A TYPE STRAIGHT  
TO FAKRA JACK STRAIGHT, OD 3.3 CABLE

THIS DRAWING CONTAINS INFORMATION THAT IS PROPRIETARY AND SHOULD NOT BE USED WITHOUT PRIOR WRITTEN PERMISSION FROM ADAM TECH

SIZE X	PART NO. CA-AM01XJ-1FJX-XM	REV. A
REF: S00013T	SCALE: NTS	SHEET 2 OF 4

6

5

4

3

2

1

6

5

4

3

2

1

APPROVED: \_\_\_\_\_

DATE: \_\_\_\_\_ TITLE: \_\_\_\_\_

Rev	AWO #	Description	Date	Appr
-----	-------	-------------	------	------

SEE SHT 1 OF 4 FOR REVISION

Fakra CA-AM01XJ-1FJX-XM

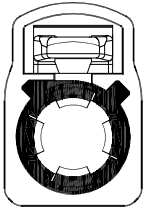
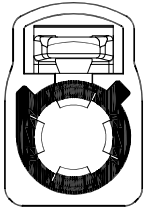
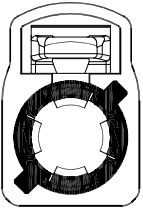
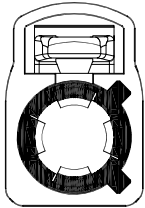
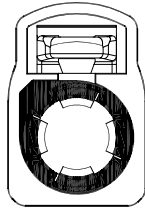
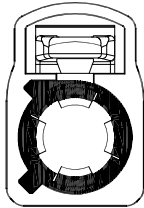
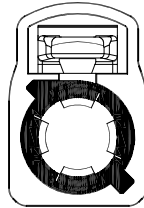
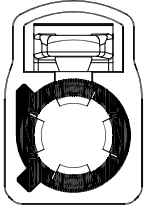
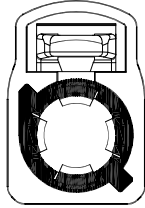
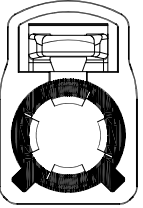
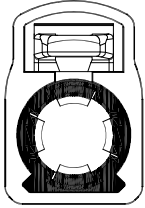
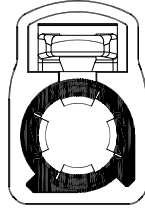
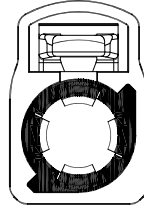
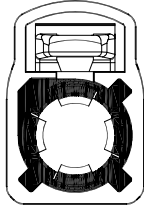
Coding	A	B	C	D	E	F	G
Plug							
Color	Black	White	Blue	Bordeaux Violet	Green	Brown	Grey
Coding	H	I	K	L	M	N	Z
Plug							
Color	Violet	Beige	Curry	Carmine Red	Pastel Orange	Pastel Green	Water Blue

UNLESS OTHERWISE SPECIFIED ALL DIMENSIONS ARE INCHES [MM]. TOLERANCES: EXCEPT AS NOTED

INCHES		HOLES	
.X	± .10	∅.X	± .10
.XX	± .020	∅.XX	± .015
.XXX	± .015	∅.XXX	± .010

**ADAM TECH**

909 Rahway Avenue,  
Union, NJ 07083  
Phone: 908-687-5000  
Fax: 908-687-5710

DRAWN	WX	6/8/22
CHECKED	JL	6/8/22
APPROVED		

TITLE  
MINI FAKRA JACK A TYPE STRAIGHT  
TO FAKRA JACK STRAIGHT, OD 3.3 CABLE

THIS DRAWING CONTAINS INFORMATION THAT IS PROPRIETARY AND SHOULD NOT BE USED WITHOUT PRIOR WRITTEN PERMISSION FROM ADAM TECH

SIZE X	PART NO. CA-AM01XJ-1FJX-XM	REV. A
REF: S00013T	SCALE: NTS	SHEET 3 OF 4

6

5

4

3

2

1

6

5

4

3

2

1

APPROVED: \_\_\_\_\_

DATE: \_\_\_\_\_ TITLE: \_\_\_\_\_

Rev	AWO #	Description	Date	Appr
-----	-------	-------------	------	------

SEE SHT 1 OF 4 FOR REVISION

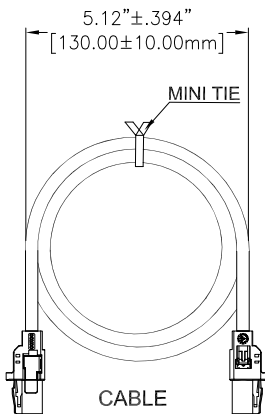

+

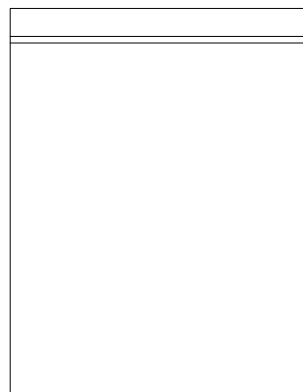

240(L)\*170(W) ZIP BAG

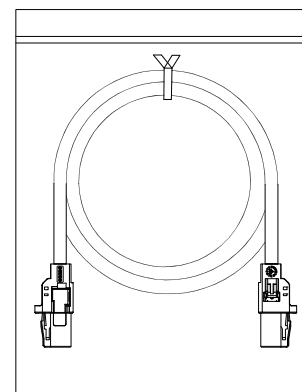

1PC/ZIP BAG

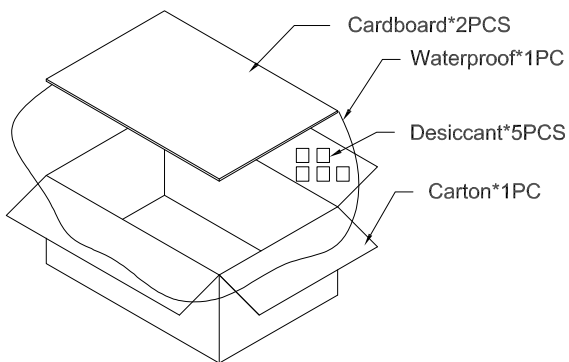

16"(L)\*13"(W)\*6.5"(H)

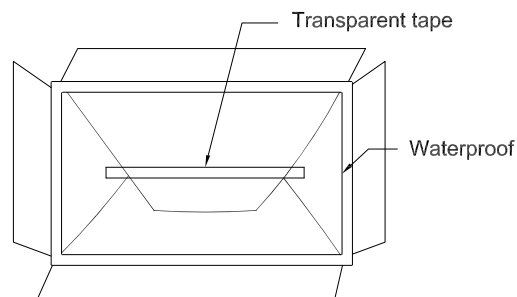

(After the installed Product, carton sealing tape should be transparent)

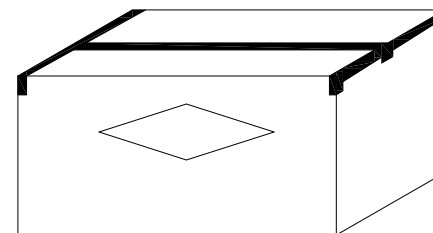

UNLESS OTHERWISE SPECIFIED ALL DIMENSIONS ARE INCHES [MM]. TOLERANCES: EXCEPT AS NOTED

INCHES		HOLES	
.X	± .10	Ø.X	± .10
.XX	± .020	Ø.XX	± .015
.XXX	± .015	Ø.XXX	± .010

**ADAM TECH**

909 Rahway Avenue,  
Union, NJ 07083  
Phone: 908-687-5000  
Fax: 908-687-5710

DRAWN	WX	6/8/22
CHECKED	JL	6/8/22
APPROVED		

TITLE  
MINI FAKRA JACK A TYPE STRAIGHT  
TO FAKRA JACK STRAIGHT , OD 3.3 CABLE

THIS DRAWING CONTAINS INFORMATION THAT IS PROPRIETARY AND SHOULD NOT BE USED WITHOUT PRIOR WRITTEN PERMISSION FROM ADAM TECH

SIZE X	PART NO. CA-AM01XJ-1FJX-XM	REV. A
REF: S00013T	SCALE: NTS	SHEET 4 OF 4

6

5

4

3

2

1