

Withwave's 2.92 mm Connectors for Waveguide are specially designed for Waveguide in/output. These connectors are available with two configurations and assembly is precisely controlled to ensure consistency of performance.



■ Specification

Scope	Items	Specification
Electrical	Freq. range	DC to 40 GHz (Mode Free Through 40 GHz)
	Impedance	50 Ohm
Material	Body	Stainless Steel (Passivated)
	Center Contact	BeCu (gold plated)
	Insulator	Utem1000
Environmental	Temperature	-40 to +135 degree
	Thermal Shock	MIL-STD-202, Method 107, Condition B
	Corrosion	MIL-STD-202, Method 101, Condition B

**RoHS Compliant*

■ Drawing

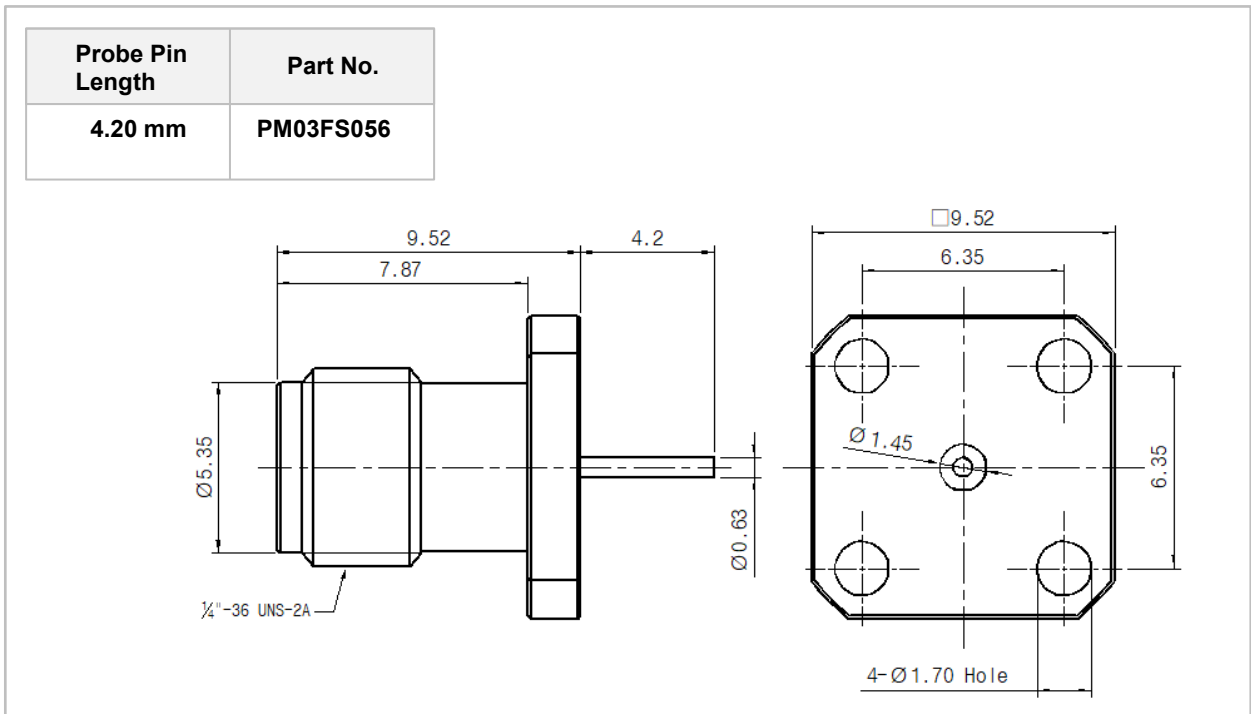
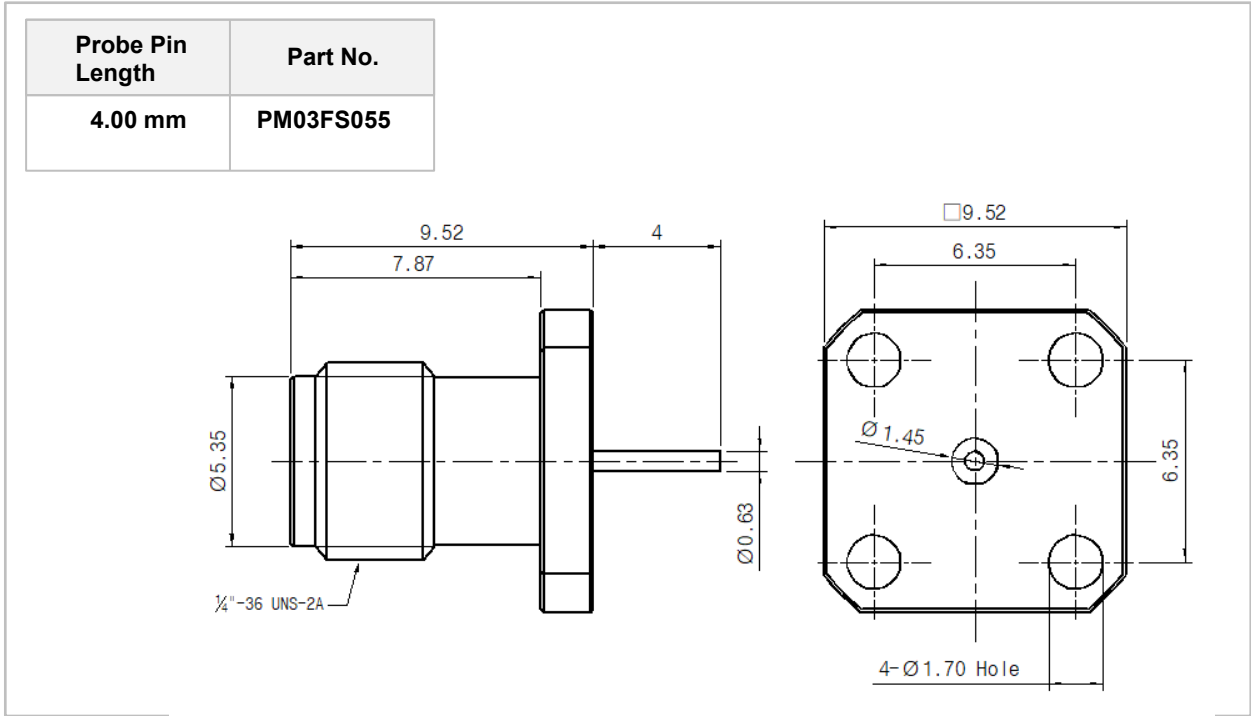

■ Drawing

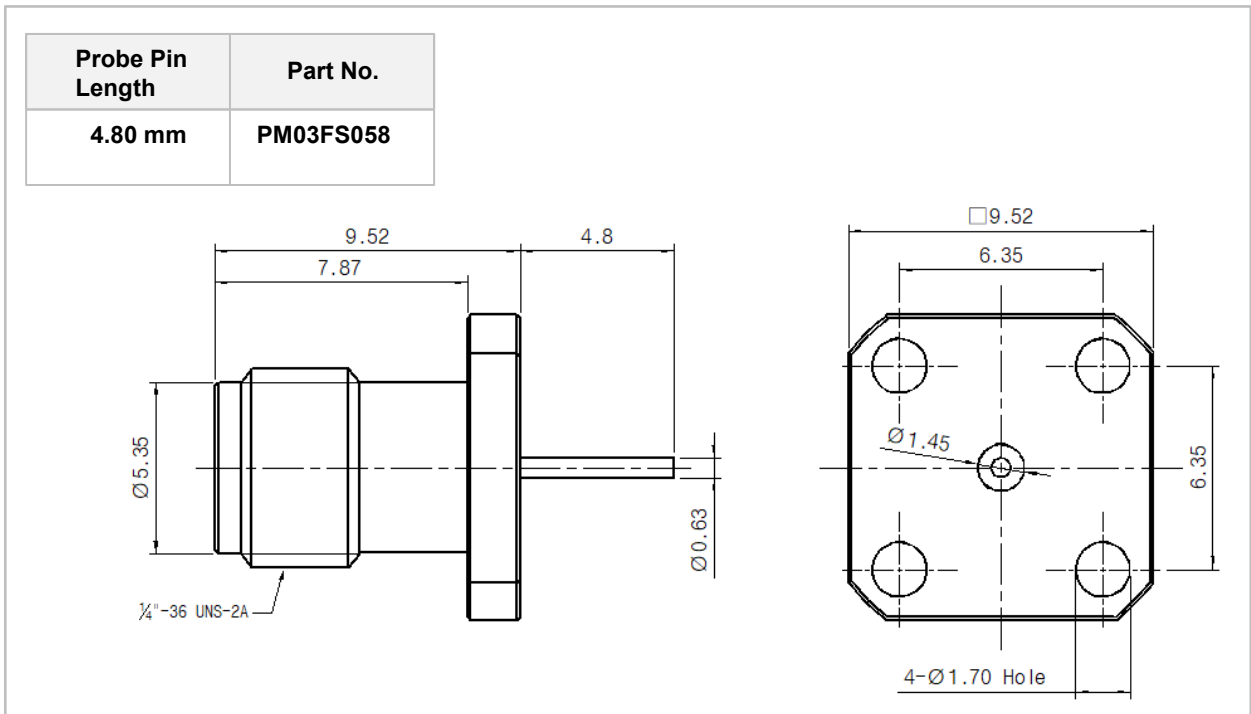
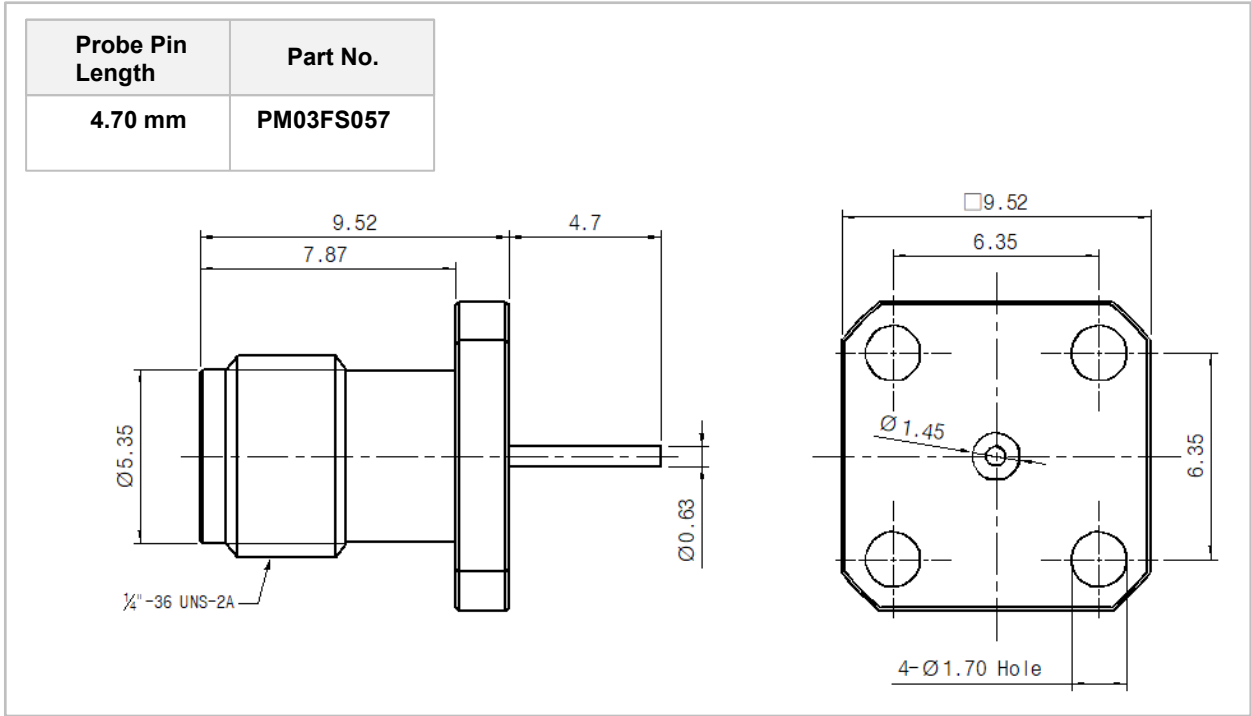

■ Drawing

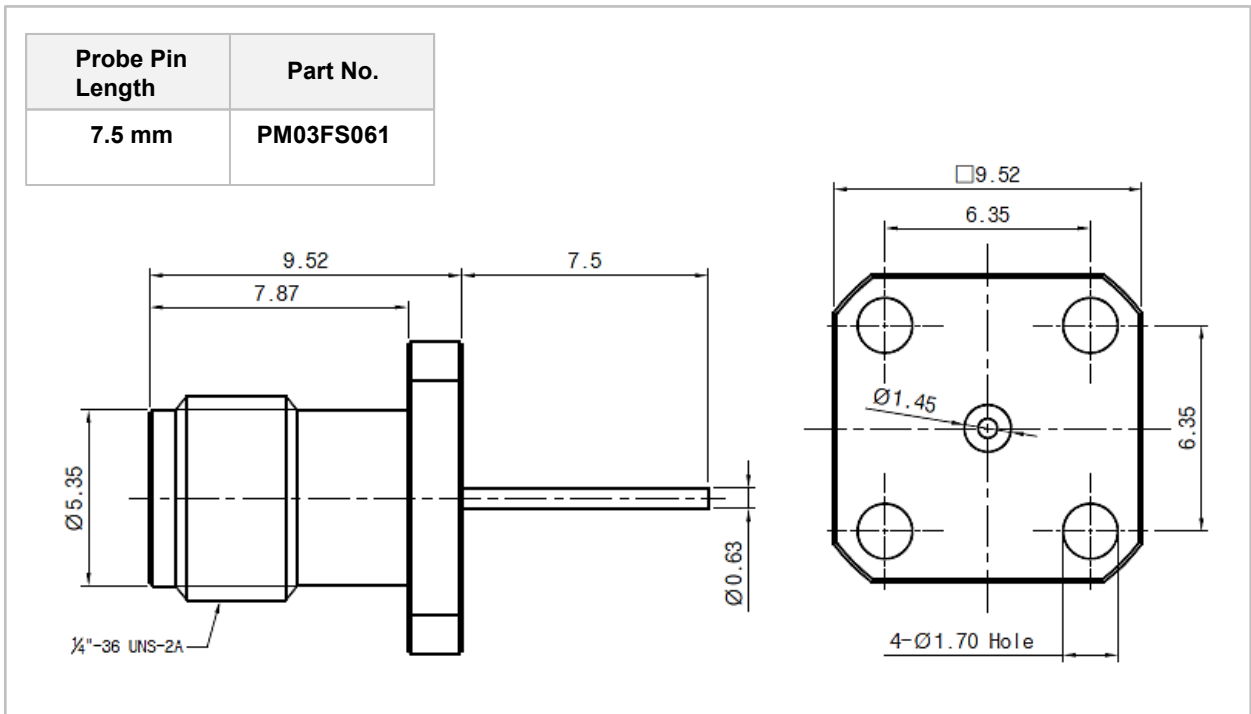
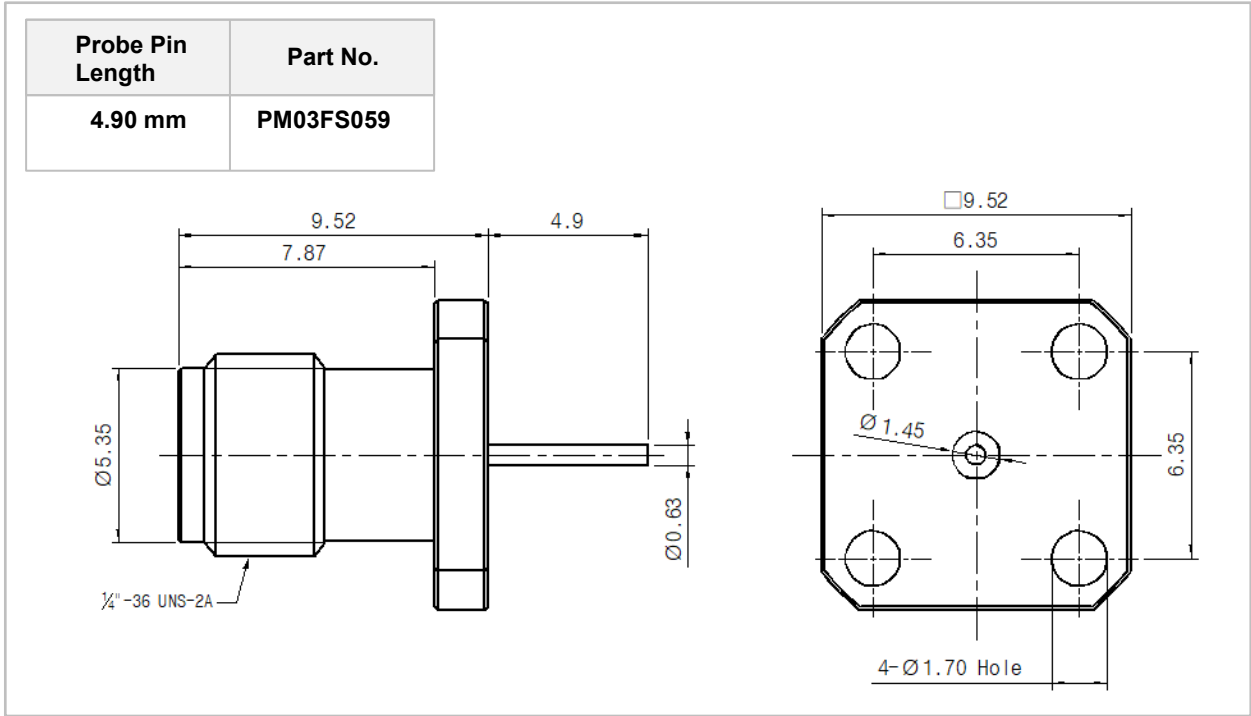

■ Drawing

