

OPT8241 Evaluation Module

User's Guide



Literature Number: SBOU155B
October 2015–Revised February 2017

1	Trademarks	3
2	Introduction	4
3	Safety	5
4	Hardware	6
	4.1 Block Diagram	6
	4.2 Design Specifications	6
	4.3 Sensor Board	7
	4.4 Illumination Board	10
	4.5 Power Supply	10
5	Calibration	12
6	Software	13
	6.1 Firmware upgrade	13
7	Known Issues	17
8	Related Documentation From Texas Instruments	17
	Revision History	17

OPT8241 Evaluation Module

This document explains the details of the hardware and its usage and provides a basic introduction to the accompanying software. Throughout this document, camera development kit, evaluation module, and the abbreviations CDK and EVM are used interchangeably and are synonymous with the term OPT8241-CDK-EVM.

1 Trademarks

Linux is a registered trademark of Linus Torvalds.
Microsoft, Windows are registered trademarks of Microsoft Corporation.
All other trademarks are the property of their respective owners.

2 Introduction

The OPT8241-CDK-EVM showcases TI's high-performance 3D Time-of-Flight (ToF) sensor OPT8241 and the ToF controller OPT9221 (TFC). The EVM is designed to be reconfigurable and modular in order to enable evaluation at a wide range of operating points and is not optimized for any specific application, by default. The accompanying software is designed to enable evaluation of the TI 3D ToF technology at various levels of detail.

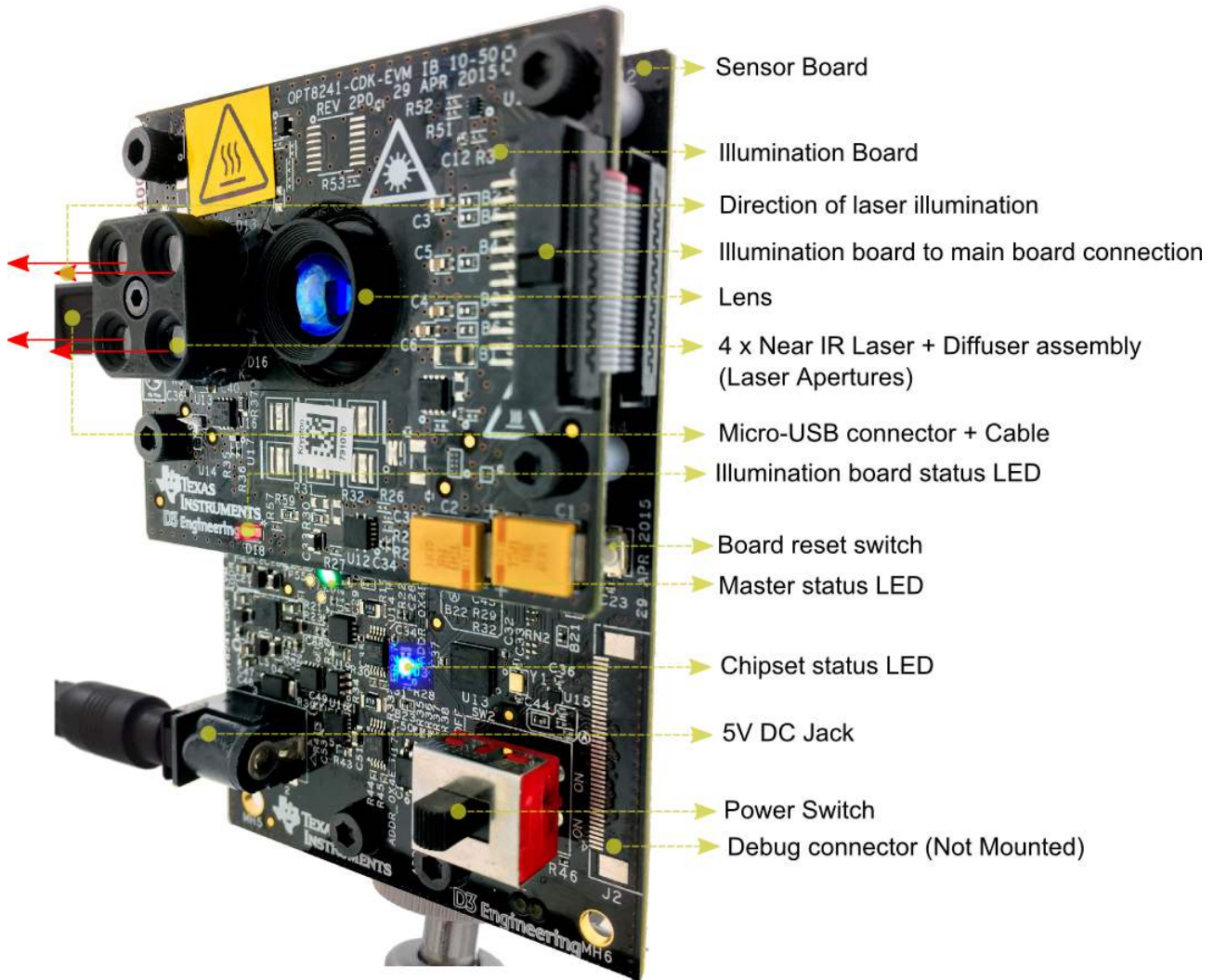

Figure 1. Components of the EVM

3 Safety

This Laser Device is designed at Class 1 during normal operation. While the OPT8241-CDK-EVM development boards meet the Class 1 classification requirements under EN/IEC60825-1 2007, users are advised to take the necessary safety caution when using the OPT8241-CDK-EVM. First, examine the board for any damage before the board is powered. Check that the diffusers and diffuser mounts are properly secured on the laser diodes. If there is any damage, stop operating by removing power from the CDK immediately. Opening the laser diffuser assembly may lead to hazardous radiation exposure. Any kind of circuit modification to the board or use of software or firmware other than the recommended EVM tools and firmware provided by TI may lead to violation of class 1 safety limits. Due to the small size and unsuitability for labeling, laser safety related labels are included herein, rather than on the product. Additional safety and manufacturer labels are included in the safety section of the [OPT8241-EVM Quick Start Guide](#).

WARNING

Use of controls or adjustments or performance of procedures other than those specified herein may result in hazardous radiation exposure.

This is a class A product as defined by standard EN 61326-1:2013. This product is not intended to be used in domestic establishments and also in establishments that are directly connected to a low-voltage power-supply network that supplies buildings used for domestic purposes. In a domestic environment this product may cause radio interference in which case the user may be required to take adequate measures.

There is no scheduled maintenance required for the OPT8241-CDK-EVM; any servicing and maintenance of this EVM shall be performed only by trained Texas Instruments or TI-appointed trained personnel. Any modification or significant damage to the CDK could potentially cause the CDK to operate outside of the EN/IEC60825 2007 Class 1 classification limits.

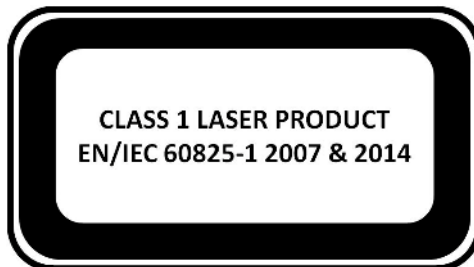

Figure 2. Explanatory Label

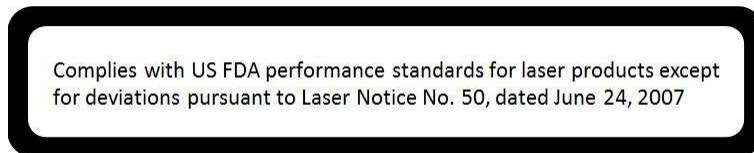

Figure 3. Certification Label

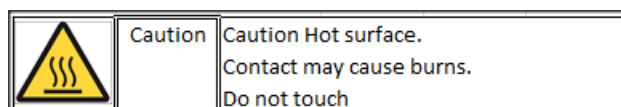

Figure 4. Hot To Touch

4 Hardware

4.1 Block Diagram

The OPT8241 sensor provides the modulation for the internal pixel array as well as for the external illumination drivers. The illumination drivers in-turn drive the laser illumination on the illumination board. The receiver light is focused using a lens on to the OPT8241 sensor. The depth correlation data obtained by the OPT8241 sensor is digitized and provided to the OPT9221 ToF Controller (TFC), the TFC then processes and provides the distance output for each pixel. A Cypress FX2 chip is used as a USB transceiver to enable PC-based acquisition of data and to control the configuration of the CDK dynamically.

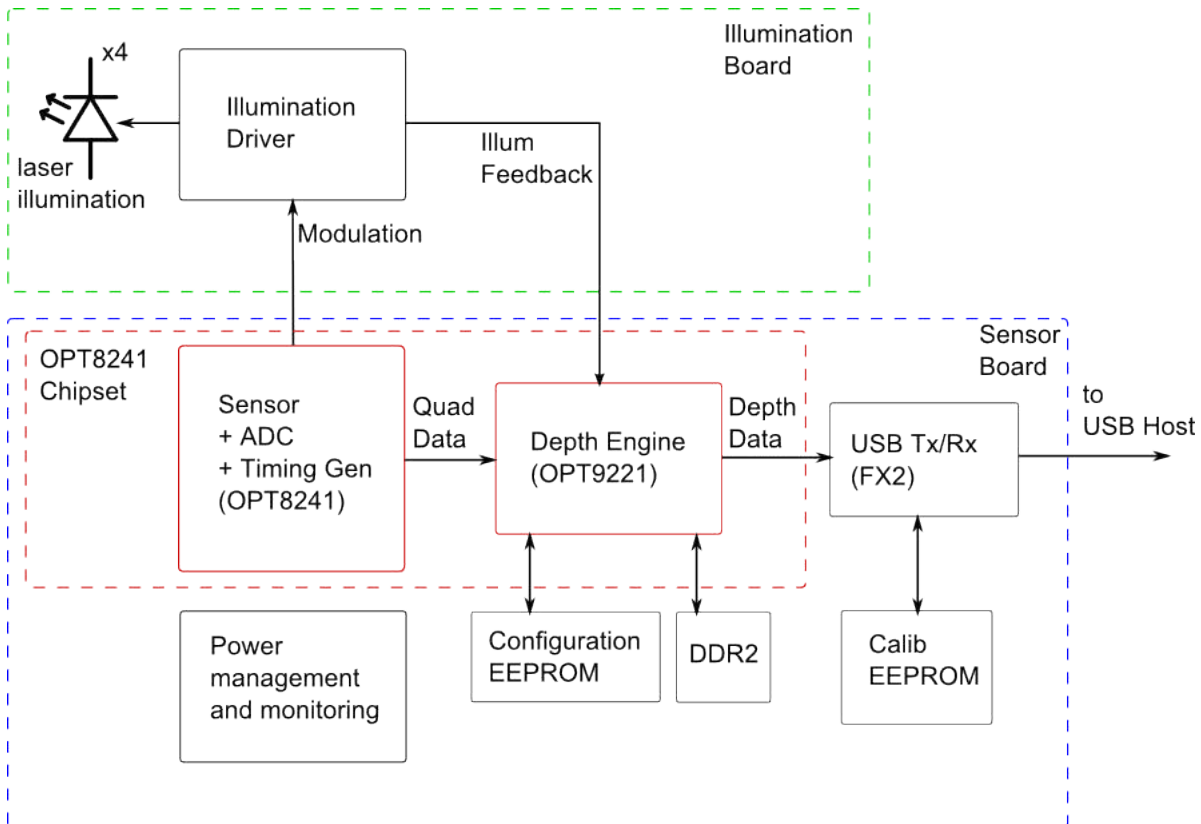

Figure 5. CDK Diagram

4.2 Design Specifications

The hardware consists of an assembly of customizable boards. The hardware comes assembled by default and it is not recommended to disassemble the hardware. The individual boards are listed below with their main constituents:

- Sensor board
 - Sensor, lens holder, lens
 - TFC, DDR2 memory
 - USB transceiver
- Illumination board
 - Lasers , diffuser, diffuser holder
 - Laser driver

The overall specifications of the CDK hardware are listed in [Table 1](#).

Table 1. Specifications

Item	Specification
Time of Flight Sensor	OPT8241
Time of Flight Controller	OPT9221
Sensor resolution	320 x 240 (QVGA)
Field of view	74.4 (H) x 59.3 (V)
Frame-rate	12 ... 60 fps
Illumination source wavelength	850 nm
Operating range	Up to 4 m
Connectivity	USB 2.0, micro connector
Cable	1.8 m, Micro USB B-type and standard Male A type
Operating Conditions	0°C to 40°C (Ambient)
CDK Power supply max power	15 Watt
Size	88.8 mm (L) x 60 mm (W) x 24.3 mm (H)

4.3 Sensor Board

The sensor board consists of all interconnects and the corresponding connectors. The illumination board is mechanically held to the sensor board using spacers. The electrical connections between illumination board and sensor board are achieved using a flex cable. The sensor board also provides an extension connector for connecting the boards to an external connector.

Figure 6. Sensor Board

The specifications for the sensor board are listed in [Table 2](#).

Table 2. Sensor Board Specifications

Item	Specification(*)
Size	88.8 mm (L) x 60 mm (W) x 18.9 mm (H)
Modulation frequency	up to 100 MHz

4.3.1 Indicator LEDs

The sensor board has 2 LEDs for indicating various operating states of the board. The master LED indicates the overall status of the board and the TFC LED indicates the status of the Time-of-Flight chipset. The various states of the board are listed in [Table 3](#).

Table 3. LED Indicator States

State	Master LED	TFC LED	Status Type
All OK, Streaming OFF	Bright Green	Blue	Info
All OK, Streaming On	Cyan	X	Info
TFC Test Mode Enabled	X	Off	Info
Firmware Upgrade in progress	Blink (Magenta)	X	Info
Firmware Upgrade done	Magenta	X	Info
DC Jack unplugged	Dimmed colors	X	Info
Overtemperature	X	Magenta	Warning
TFC booted, but status failed	X	Red	Error
TFC did not boot	Blink (Red)	Off	Error

In usual operating conditions, the master LED should be green/cyan and the TFC LED should be blue.

4.3.2 Power Switch

The power switch controls the power to both the sensor and the illumination board. The switch controls are shown in [Figure 7](#).

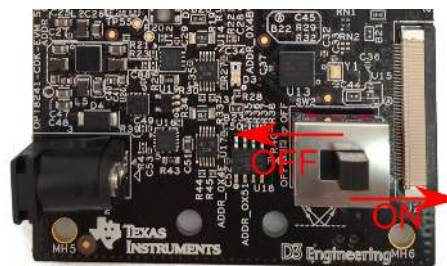

Figure 7. Power Switch

4.3.3 Reset Switch

The reset switch resets the entire board without the need to power-cycle the board. As part of the reset process, the reset triggers a USB connect and disconnect on the USB and output data streaming will stop. This may cause the evaluation software on the PC to misbehave if the software is in connected state. Disconnect and connect operations on the software should restore the CDK operation with reset parameters. [Figure 8](#) shows the location of the reset switch.

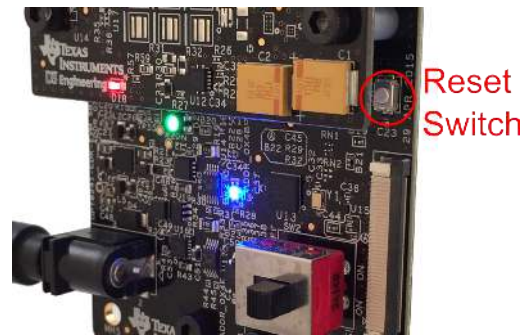

Figure 8. Reset Switch

4.3.4 Lens Assembly

The lens and the lens mount are both custom parts. To allow the use of standard off-the-shelf lenses, a standard [M12 lens mount](#) footprint has been provided.

4.3.5 Tripod Mount

A tripod mount comes assembled with the hardware. The tripod mount can be unscrewed from the assembly, if necessary. [Figure 9](#) shows the tripod mount location and the screws that hold the tripod mount to the rest of the assembly.



Figure 9. Tripod Mount

4.4 Illumination Board

The illumination board consists of 4 IR lasers mounted with diffusers and the laser driver ckt. The optical output power of the illumination board is controlled using an I²C interface-based digital potentiometer. The voxel viewer software can be used to configure the digital potentiometer. The modulation control of the illumination is done by the OPT8241 sensor and the corresponding signals from the sensor board to the illumination board via a flex cable.

Table 4 lists the specifications of the illumination boards.

Table 4. Illumination Board Specifications

Item	Specification ⁽¹⁾
Size	60 mm (W) x 48.5 mm (L) x 12.1 mm (H)
Illumination type	4 x Near IR Laser
Average Output Power(^)	1.5 W
Peak optical output power	10 W
Modulation frequency	12-MHz to 80-MHz square wave at 50% duty cycle
Pulse train width	18 μ s–28 ms
Wavelength	850 nm
Laser Beam Divergence	80° at 90% power relative to the center
Laser Beam Shape	Circular
Transverse Beam Mode	Diffused
Diffuser Material	EDC-80, RPC photonics

⁽¹⁾ All values are typical.

The illumination power can be changed only between 40% to 100% of the total power. Values below 40% of the maximum power are not supported. Since each board's maximum power is individually tuned to make sure that the 100% power setting meets the laser safety requirements, the valid steps between 40% to 100% power can differ across CDKs.

4.5 Power Supply

The image of the power supply recommended for use with the CDK along with all the blade options is shown in Figure 10.



Figure 10. Power Supply

The power supply specifications are shown in [Table 5](#).

Table 5. Power Supply Specifications

Item	Specification ⁽¹⁾
Part Number	EMSA050300-P5RP-SZ
Output Voltage	5 V
Output Current	Up to 3 A
Input Voltage	90 ≈ 264 VAC
Frequency	47 to 63 Hz
Efficiency	Level V
Blade options	US, UK, Europe, Australia, China

⁽¹⁾ All values are typical.

NOTE: TI recommends using an external power supply that complies with applicable regional safety standards such as (by example) UL, CSA, VDE, CCC, PSE, and so forth.

5 Calibration

The CDK is factory-calibrated. The calibration on the CDK is for demonstration purposes only and is not meant to be treated as the most accurate calibration possible. Since the CDK can be configured dynamically using the software, the CDK goes out of calibration whenever a critical parameter is changed. Three default profiles are provided in the hardware to serve as templates. [Table 6](#) lists the default calibration profiles.

Table 6. Calibration Profiles

Parameter	Long Range	Short Range	High Ambient
Parent Profile	Lens Only	Long Range	Long Range
Frame rate (fps)	30	60	30
Sub-Frames	4	2	4
Quads	6	6	6
Integration Duty Cycle (%)	30	10	5
De-aliasing	Enabled	Enabled	Enabled
Illumination Power (%)	100	40	100
Unambiguous Range (m)	10	5	5
Base Frequency (MHz)	60	60	60
De-aliasing Frequency (MHz)	40	40	40
Usable Range	4 m	1.5 m	1.5 m
Calibrations performed	Temperature, Common phase offset, Pixel to Pixel, Pixel cross-talk ⁽¹⁾	Common phase offset ⁽²⁾	Common phase offset ⁽²⁾

⁽¹⁾ Since Long range profile derives from lens calibration profile, lens calibration is not redone in long range profile.

⁽²⁾ Profiles that have a parent derive all the calibrations from the parent. Calibrations in a child override the calibrations derived from the parent.

Calibration is very sensitive to system parameter changes. Any change in a parameter value could put the CDK in a non-calibrated state. The most common parameter changes that mandate re-calibration are listed in [Table 7](#).

Table 7. Calibration Sensitivity Table

Parameter Changed	Re-Calibration Required?		
	Common phase offset	Pixel-to-Pixel Differences	Non-Linearity Calibration, Pixel Cross-Talk Calibration
Unambiguous range (any change in modulation frequency)	Yes	Yes	Yes
Frame rate, number of quads, number of sub-frames (any change in quad timing)	Yes, but to a small extent	No	No
Integration duty cycle	Yes, but to a small extent	No	No
Illumination power	Yes	No	No

6 Software

The CDK is supported by the open source 3D Camera software development kit – [Voxel-SDK](#). To make the evaluation easier, Voxel Viewer, a closed source viewer built on top of Voxel SDK is provided by TI. The viewer supports the following functionality:

- View the following streamed data real-time:
 - Phase
 - Amplitude
 - Ambient
 - Distance
 - Depth
 - Point cloud
- Configure the camera settings
- Basic statistics:
 - Temporal and spatial averaging
 - Temporal and spatial standard deviation
 - Histogram
- Filters (Spatial and temporal):
 - Filter addition/deletion/insertion
 - Configuration of filter coefficients
- Calibrate the camera
- OPT9221 firmware update

The details of the viewer are covered in the [Voxel Viewer User's Guide](#).

6.1 Firmware upgrade

The CDK has two firmware. The FX2 firmware and the TFC (OPT9221) firmware. Both the firmware are stored in separate EEPROMs. Firmware upgrade is a critical activity and the following precautions must be adhered to:

- The CDK should be adequately powered using the recommended power adapter.
- Only the recommended software should be used for firmware upgrade.
- Loading firmware other than the firmware provided by TI is not recommended and could lead to hardware failure.

6.1.1 FX2 Firmware upgrade

FX2 firmware upgrade is accomplished using the Cypress Control Center tool. The procedure follows:

- Launch the cypress control center tool. If the CDK is connected, the CDK is listed in the control center tool.
- Choose "TI 3D TOF CDK OPT8241" among the devices listed.
- Click on the menu option – **Program** → **FX2** → **64KB EEPROM**.
- Choose the provided firmware file and click on open to start the programming.
- If the programming goes through, the status bar shows "Programming Succeeded".

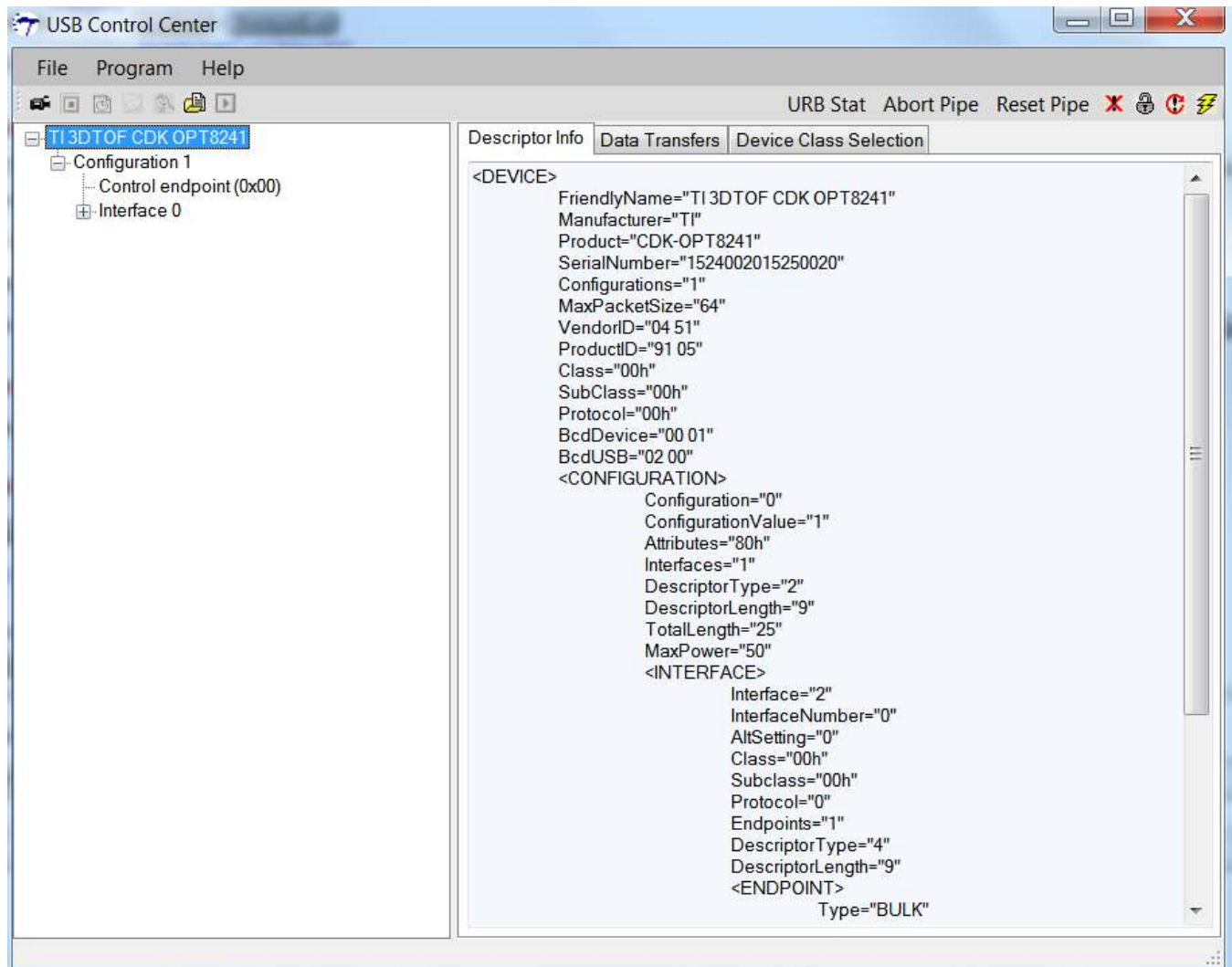

Figure 11. Cypress Control Center

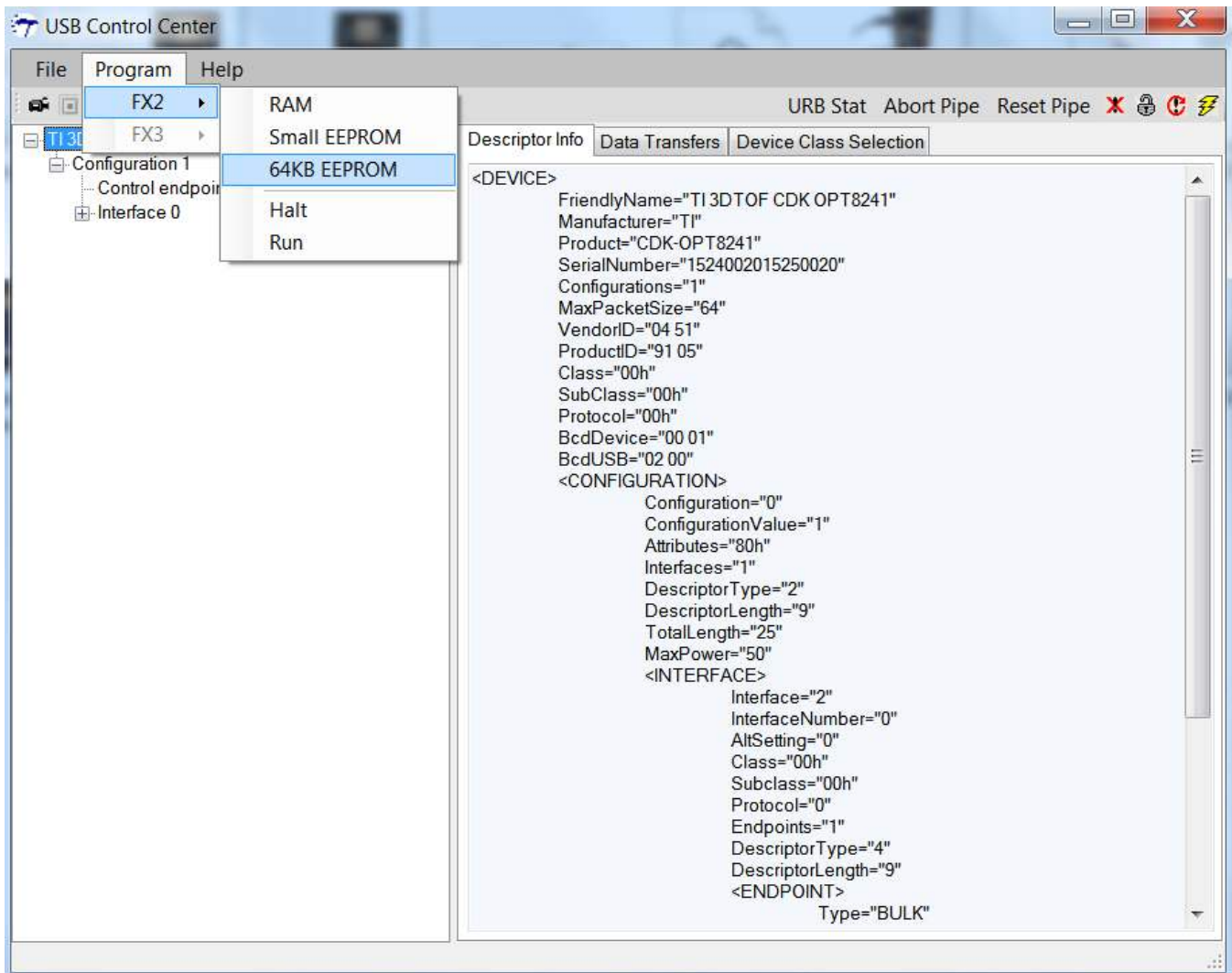

Figure 12. Program Menu

6.1.2 TFC (OPT9221) Firmware Upgrade

The OPT9221 firmware can be updated using the Voxel-Viewer tool. The procedure follows:

- If the Voxel Viewer application is already running and connected to the CDK, launch the "Voxel Programmer" utility from the menu – **File** → **Open Programmer**
- If the Voxel Viewer application is not running, the "Voxel Programmer" utility can be directly launched from the start menu in Microsoft® Windows® or from a terminal in Linux®.
- Once the programmer is open and is connected to the CDK, choose the provided OPT9221 firmware file and click on the download button.

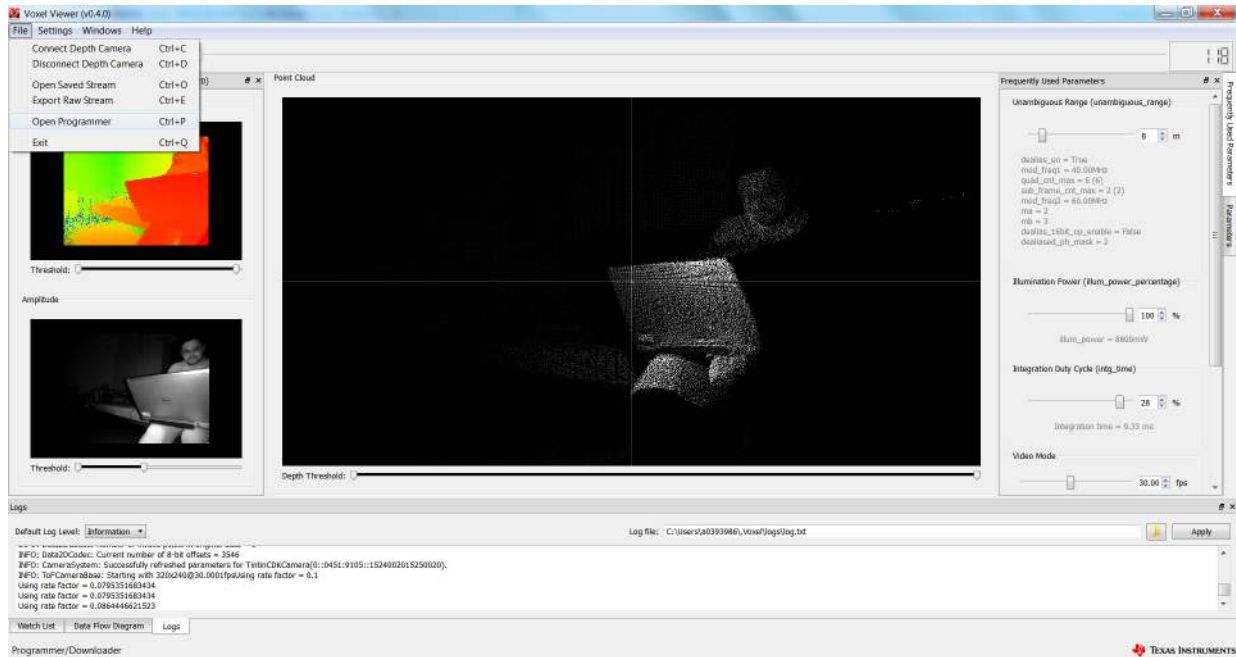

Figure 13. Launching the Programmer From the Voxel Viewer

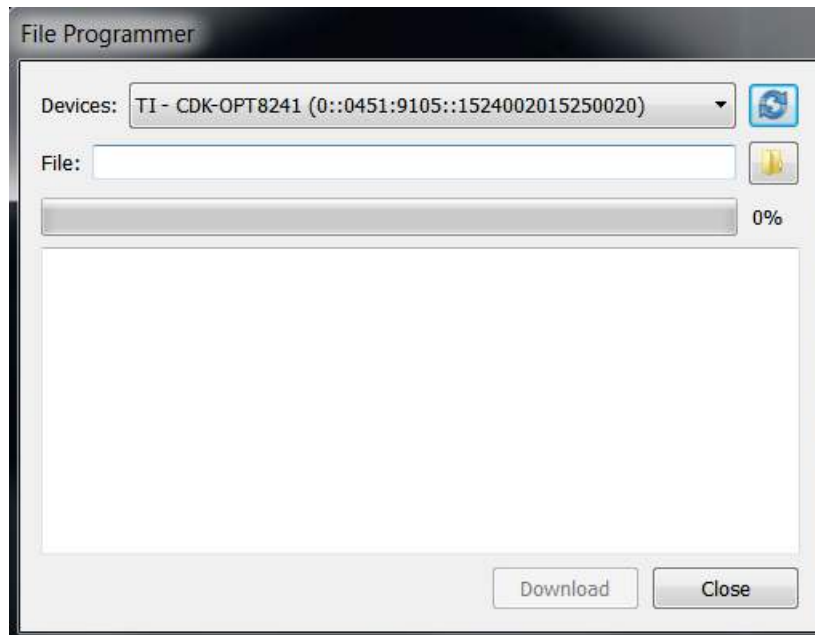

Figure 14. OPT9221 Firmware Download

7 Known Issues

List of known issues for the hardware revision Rev2P0:

- Hardware issues:
 - When the USB cable is connected, the red LED on the illumination board turns on even when the power switch is in the off position. This behavior is not harmful and the rest of the circuit is indeed powered off. Occasional blinking may also be observed.
 - The lens mount has no alignment tabs. This results into incorrect centering and hence noticeable vignetting near the corners of the image.
 - Hot unplug of power supply DC jack may lead to power failure and board reset.
 - The OPT8241 LVDS data capture on the TFC has latency issues and will be fixed in a future OPT9221 firmware. As of firmware version 0.23, the latency issue is not resolved. The issue manifests itself as a 1-in-8 column pattern both in phase and amplitude images and disappears when "data_latency" parameter is adjusted by ± 1 .
- Calibration issues:
 - Frequency calibration is not performed on the boards. This may lead to gain errors in distance measurement.
 - Non-linearity calibration is not performed on the boards. This may lead to varying phase slopes versus distance.

8 Related Documentation From Texas Instruments

Related documentation regarding the EVM is available here: <http://www.ti.com/tool/opt8241-cdk-evm>. The documentation related to the ToF chipset used in the EVM is available in the following:

- Sensor - <http://www.ti.com/product/OPT8241>
- Time-of-Flight Controller - <http://www.ti.com/product/OPT9221>

Revision History

NOTE: Page numbers for previous revisions may differ from page numbers in the current version.

Changes from A Revision (February 2016) to B Revision	Page
• Added class A product statement pertaining to EN 61326-1:2013 in the <i>Safety</i> section.	5

IMPORTANT NOTICE FOR TI DESIGN INFORMATION AND RESOURCES

Texas Instruments Incorporated ("TI") technical, application or other design advice, services or information, including, but not limited to, reference designs and materials relating to evaluation modules, (collectively, "TI Resources") are intended to assist designers who are developing applications that incorporate TI products; by downloading, accessing or using any particular TI Resource in any way, you (individually or, if you are acting on behalf of a company, your company) agree to use it solely for this purpose and subject to the terms of this Notice.

TI's provision of TI Resources does not expand or otherwise alter TI's applicable published warranties or warranty disclaimers for TI products, and no additional obligations or liabilities arise from TI providing such TI Resources. TI reserves the right to make corrections, enhancements, improvements and other changes to its TI Resources.

You understand and agree that you remain responsible for using your independent analysis, evaluation and judgment in designing your applications and that you have full and exclusive responsibility to assure the safety of your applications and compliance of your applications (and of all TI products used in or for your applications) with all applicable regulations, laws and other applicable requirements. You represent that, with respect to your applications, you have all the necessary expertise to create and implement safeguards that (1) anticipate dangerous consequences of failures, (2) monitor failures and their consequences, and (3) lessen the likelihood of failures that might cause harm and take appropriate actions. You agree that prior to using or distributing any applications that include TI products, you will thoroughly test such applications and the functionality of such TI products as used in such applications. TI has not conducted any testing other than that specifically described in the published documentation for a particular TI Resource.

You are authorized to use, copy and modify any individual TI Resource only in connection with the development of applications that include the TI product(s) identified in such TI Resource. NO OTHER LICENSE, EXPRESS OR IMPLIED, BY ESTOPPEL OR OTHERWISE TO ANY OTHER TI INTELLECTUAL PROPERTY RIGHT, AND NO LICENSE TO ANY TECHNOLOGY OR INTELLECTUAL PROPERTY RIGHT OF TI OR ANY THIRD PARTY IS GRANTED HEREIN, including but not limited to any patent right, copyright, mask work right, or other intellectual property right relating to any combination, machine, or process in which TI products or services are used. Information regarding or referencing third-party products or services does not constitute a license to use such products or services, or a warranty or endorsement thereof. Use of TI Resources may require a license from a third party under the patents or other intellectual property of the third party, or a license from TI under the patents or other intellectual property of TI.

TI RESOURCES ARE PROVIDED "AS IS" AND WITH ALL FAULTS. TI DISCLAIMS ALL OTHER WARRANTIES OR REPRESENTATIONS, EXPRESS OR IMPLIED, REGARDING TI RESOURCES OR USE THEREOF, INCLUDING BUT NOT LIMITED TO ACCURACY OR COMPLETENESS, TITLE, ANY EPIDEMIC FAILURE WARRANTY AND ANY IMPLIED WARRANTIES OF MERCHANTABILITY, FITNESS FOR A PARTICULAR PURPOSE, AND NON-INFRINGEMENT OF ANY THIRD PARTY INTELLECTUAL PROPERTY RIGHTS.

TI SHALL NOT BE LIABLE FOR AND SHALL NOT DEFEND OR INDEMNIFY YOU AGAINST ANY CLAIM, INCLUDING BUT NOT LIMITED TO ANY INFRINGEMENT CLAIM THAT RELATES TO OR IS BASED ON ANY COMBINATION OF PRODUCTS EVEN IF DESCRIBED IN TI RESOURCES OR OTHERWISE. IN NO EVENT SHALL TI BE LIABLE FOR ANY ACTUAL, DIRECT, SPECIAL, COLLATERAL, INDIRECT, PUNITIVE, INCIDENTAL, CONSEQUENTIAL OR EXEMPLARY DAMAGES IN CONNECTION WITH OR ARISING OUT OF TI RESOURCES OR USE THEREOF, AND REGARDLESS OF WHETHER TI HAS BEEN ADVISED OF THE POSSIBILITY OF SUCH DAMAGES.

You agree to fully indemnify TI and its representatives against any damages, costs, losses, and/or liabilities arising out of your non-compliance with the terms and provisions of this Notice.

This Notice applies to TI Resources. Additional terms apply to the use and purchase of certain types of materials, TI products and services. These include; without limitation, TI's standard terms for semiconductor products (<http://www.ti.com/sc/docs/stdterms.htm>), [evaluation modules](#), and [samples](http://www.ti.com/sc/docs/sampterm.htm) (<http://www.ti.com/sc/docs/sampterm.htm>).

Mailing Address: Texas Instruments, Post Office Box 655303, Dallas, Texas 75265
Copyright © 2018, Texas Instruments Incorporated