

XCKJ10511D

Limit switch, Limit switches XC Standard, XCKJ, thermoplastic roller lever, 1NC+1 NO, snap action, M12



Main

Range of Product	Telemecanique Limit switches XC Standard
Series name	Standard format
Product or Component Type	Limit switch
Device short name	XCKJ
Sensor design	Form A CENELEC EN 50041
Body type	Fixed
Head type	Rotary head
Material	Metal
Body Material	Zamak
Head material	Zamak
Fixing Mode	By the body
Movement of operating head	Rotary
Type of operator	Spring return roller lever thermoplastic
Type of approach	Lateral approach, 1 or 2 programmable direction
Number of poles	2
Contacts type and composition	1 NC + 1 NO
Contact operation	Snap action

Complementary

Switch actuation	By 30° cam
Electrical connection	Male connector M12, 5 pins
Contacts insulation form	Zb
Number of steps	1
Positive opening	With
Positive opening minimum torque	4.43 lbf.in (0.5 N.m)
Minimum torque for tripping	2.21 lbf.in (0.25 N.m)
Maximum actuation speed	4.92 ft/s (1.5 m/s)
[Ie] rated operational current	0.27 A 50 V, DC-13 EN/IEC 60947-5-1 appendix A 3 A 50 V, AC-15 EN/IEC 60947-5-1 appendix A
[Ithe] conventional enclosed thermal current	4 A
[Ui] rated insulation voltage	60 V 3)IEC 60947-1
Maximum resistance across terminals	25 MOhm IEC 60255-7 category 3
[Uimp] rated impulse withstand voltage	0.8 KV IEC 60664 0.8 kV IEC 60947-1
Short-circuit protection	4 A cartridge fuse gG
Electrical durability	5000000 Cycles, DC-13, inductive, 24 V, 10 W 60 cyc/mn 0.5 IEC 60947-5-1 appendix C 5000000 cycles, DC-13, inductive, 48 V, 7 W 60 cyc/mn 0.5 IEC 60947-5-1 appendix C
Mechanical durability	30000000 cycles
Width	1.57 in (40 mm)
Height	3.50 in (89 mm)
Depth	1.73 in (44 mm)
Net Weight	1.06 lb(US) (0.48 kg)
Terminals description ISO n°1	(13-14)NO (21-22)NC

Environment

Shock resistance	50 gn 11 ms IEC 60068-2-27
Vibration resistance	25 gn 10...500 Hz)IEC 60068-2-6
IP degree of protection	IP66 conforming to IEC 60529
IK degree of protection	IK07 EN 50102
Overvoltage category	Class I IEC 61140 Class I NF C 20-030
Ambient air temperature for operation	-13...158 °F (-25...70 °C)
Ambient Air Temperature for Storage	-40...158 °F (-40...70 °C)
Protective treatment	TC
Product Certifications	CCC CSA UL
Standards	EN 60204-1 IEC 60204-1 UL 508 IEC 60947-5-1 CSA C22.2 No 14 EN 60947-5-1 CENELEC EN 50041

Ordering and shipping details

Category	22411-LIMIT SWITCHES,IEC,XCKJ
Discount Schedule	T
GTIN	3389110388893
Nbr. of units in pkg.	1
Package weight(Lbs)	17.57 oz (498 g)
Returnability	No
Country of origin	FR

Packing Units

Unit Type of Package 1	PCE
Package 1 Height	1.57 in (4 cm)
Package 1 width	7.87 in (20 cm)
Package 1 Length	2.20 in (5.6 cm)
Unit Type of Package 2	S02
Number of Units in Package 2	20
Package 2 Weight	22.73 lb(US) (10.308 kg)
Package 2 Height	5.91 in (15 cm)
Package 2 width	11.81 in (30 cm)
Package 2 Length	15.75 in (40 cm)

Offer Sustainability

Sustainable offer status	Green Premium product
California proposition 65	WARNING: This product can expose you to chemicals including: Diisononyl phthalate (DINP), which is known to the State of California to cause cancer, and Di-isodecyl phthalate (DIDP), which is known to the State of California to cause birth defects or other reproductive harm. For more information go to www.P65Warnings.ca.gov
REACH Regulation	REACH Declaration
EU RoHS Directive	Pro-active compliance (Product out of EU RoHS legal scope) EU RoHS Declaration
Mercury free	Yes
RoHS exemption information	Yes
Environmental Disclosure	Product Environmental Profile

Contractual warranty

Warranty	18 months
----------	-----------

Mounting with Cable Entry

Position of Cable Gland

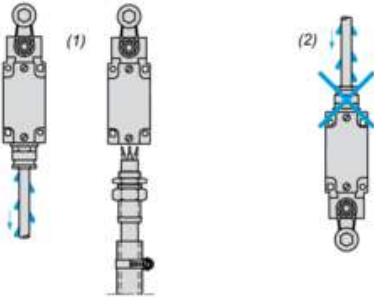

- (1) Recommended
- (2) To be avoided

Mounting with Rotary Heads and Levers

Type of Cam

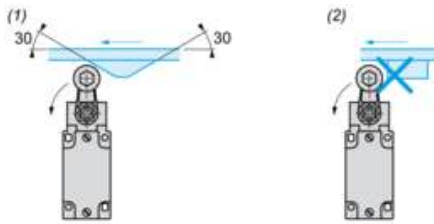

- (1) Recommended
- (2) To be avoided

Setting-up with Lever Head

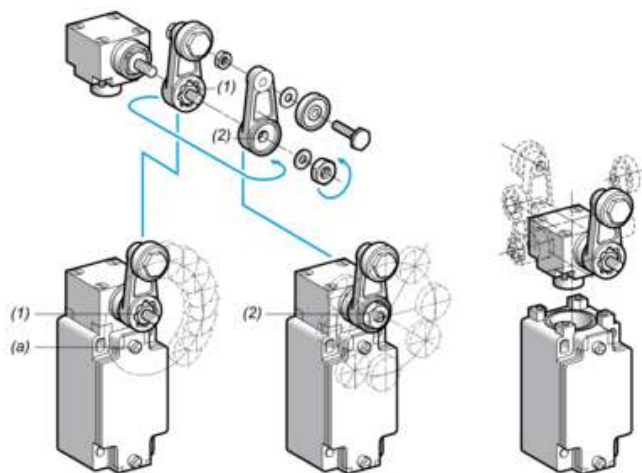

- (1) 5° steps throughout 360° / Tightening torque (Min : 1) (Max : 1.5)
- (2) 45° steps throughout 360° / Tightening torque (Min : 1) (Max : 1.5)
- (a) Tightening torque (Min : 1) (Max : 1.5)

Setting-up with Head ZCKE05

Direction of Actuation Programming



Wiring Diagram

2-pole NC + NO Snap Action

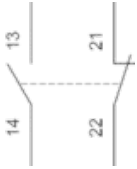

Wiring Diagram

Connections

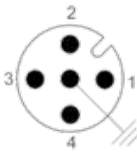

1-2 : NC

3-4 : NO

Characteristics of Actuation

Switch Actuation on End

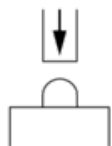

Functionnal Diagram

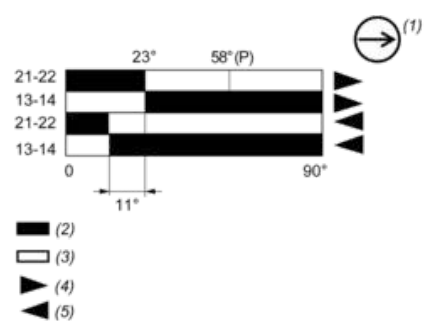

(P) Positive opening point

(1) NC contact with positive opening operation

(2) Closed

(3) Open

(4) Tripping

(5) Resetting