

## Description

Single and multipole magnetic circuit breakers with trip-free mechanism and toggle actuation. A choice of fast magnetic only or hydraulically delayed switching characteristics (S-type MO or HM CBE to EN 60934) ensures suitability for a wide range of applications. Industry standard dimensions and panel mounting. Options include auxiliary changeover contacts, or relay trip function. Low temperature sensitivity at rated load. Approved to CBE standard EN 60934 (IEC 60934).

## Typical applications

Control equipment, communications systems, transportation, power supplies.

## Standard current ratings and typical internal resistance values

Current rating (A)	Curves and internal resistance per pole ( $\Omega$ )			
	F1	F2	K1, M1, T1	K2, M2, T2
0.02	1493	953	2669	2457
0.05	276	152	452	376
0.1	58	37	100	94
0.25	8.2	6.0	15.5	14.7
0.5	2.3	1.47	3.9	3.2
0.75	0.98	0.63	1.65	1.56
1	0.58	0.35	0.95	0.90
2	0.145	0.096	0.26	0.20
2.5	0.096	0.061	0.15	0.15
3	0.065	0.048	0.10	0.10
5	0.025	< 0.02	0.042	0.040
6	< 0.02	< 0.02	0.029	0.028
8	< 0.02	< 0.02	< 0.02	< 0.02
10	< 0.02	< 0.02	< 0.02	< 0.02
12	< 0.02	< 0.02	< 0.02	< 0.02
15	< 0.02	< 0.02	< 0.02	< 0.02
16	< 0.02	< 0.02	< 0.02	< 0.02
20	< 0.02	< 0.02	< 0.02	< 0.02
25	< 0.02	< 0.02	< 0.02	< 0.02
30	< 0.02	< 0.02	< 0.02	< 0.02
40	$\leq 0.01$	-	$\leq 0.01$	-
50	$\leq 0.01$	-	$\leq 0.01$	-

Corrosion	96 hours at 5 % salt mist to IEC 60068-2-11, test Ka
Humidity	240 hours at 95 % RH to IEC 60068-2-78, test Cab
Mass	approx. 65 g per pole

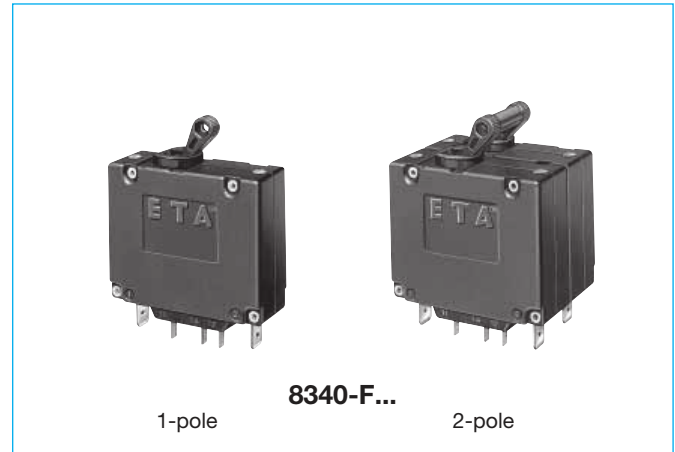

1-pole

8340-F...

2-pole

## Technical data

<b>For further details please see chapter: Technical Information</b>		
Voltage rating	3 AC 415 V; AC 240 V, 50/60 Hz; DC 80 V (higher DC ratings to special order)	
Current ratings	0.02...50 A 1-pole (40 + 50 A DC only) 0.02...30 A multipole	
Auxiliary circuit	6 A, AC 240 V; 3 A, DC 28 V 1 A, DC 65 V; 0.5 A, DC 80 V	
Typical life	3 AC 415 V, AC 240 V: 0.02...30 A 6,000 operations at $1 \times I_N$ , inductive 10,000 operations at $1 \times I_N$ , resistive DC 80 V: 0.02...25 A 6,000 operations at $1 \times I_N$ , inductive 0.02...30 A 10,000 operations at $1 \times I_N$ , resistive 40 + 50 A 6,000 operations at $1 \times I_N$ , resistive	
Ambient temperature	-40...+85 °C (-40...+185 °F)	
Insulation co-ordination (IEC 60664 and 60664A)	rated impulse withstand voltage 2.5 kV reinforced insulation in operating area	pollution degree 2
Dielectric strength (IEC 60664 and 60664A)	test voltage operating area AC 3,000 V pole to pole (2- and 3-pole) AC 1,500 V main to auxiliary circuit AC 3,000 V switching to trip circuit AC 1,500 V (version -X)	
Insulation resistance	> 100 M $\Omega$ (DC 500 V)	
Interrupting capacity $I_{cn}$	1,200 A at AC - 2,000 A at DC	
Interrupting capacity (UL 1077)	$I_N$ 0.02...20 A 25...30 A	
	AC: 1-pole AC 250 V/3,500A AC 250 V/3,500A	
	2-pole AC 250 V/3,500A AC 250 V/5,000A	
	3-pole 3AC 250V/3,500A 3AC250V/5,000A	
	DC: 1-pole 0.02...50 A DC 80 V/3,500 A	
	2-pole 0.02...30 A DC 80 V/3500 A	
Interrupting capacity (UL 489A)	2,000 A	
Degree of protection (IEC 60529/DIN 40050)	operating area IP40 terminal area IP00	
Vibration	with toggle down: 10 g (57-2000Hz) $\pm$ 0.76 mm (10-57 Hz) at $0.9 \times I_N$ directions 1, 2, 3, 4, 5: 10 g (57-2000 Hz) at $1 \times I_N$ . with curves F1, F2 in all planes: 10 g (57-2000 Hz) $\pm$ 0.76 mm (10-57 Hz) at $0.8 \times I_N$ , to IEC 60068-2-6, test Fc 10 frequency cycles/axis	
Shock	100 g (11 ms) at $1 \times I_N$ , directions 1,2,3,4,5 100 g (11 ms) at $0.8 \times I_N$ , direction 6. with curves F1, F2: 100 g (11 ms) at $0.8 \times I_N$ to IEC 60068-2-27, test Ea	

**Ordering information**

<b>Type No.</b>									
8340 magnetic circuit breaker with toggle actuator									
<b>Mounting</b>									
F flange mounting									
<b>Configuration</b>									
1 with mounting nuts 6-32 UNC									
4 with mounting nuts M3									
9 snap-in frame									
<b>Number of poles</b>									
0 single pole, switch only									
1 single pole protected									
2 two pole protected									
3 three pole protected									
4 four pole protected									
5 two pole, protected on one pole only									
6 four pole, protected on poles 1, 2 and 3 only									
7 two pole, switch only									
<b>Panel hardware</b>									
0 without panel hardware									
<b>Terminal design (main contact)</b>									
K3 screw terminals with metric thread, M4 (recommended for $I_N \geq 20$ A)									
K4 screw terminals with metric thread, M5 ( $I_N = 40$ A)									
P1 blade terminals									
X1 blade terminals with separate switching and relay circuit									
<b>Characteristic curves</b>									
<b>Characteristic curve F, instantaneous trip:</b>									
F1 DC trip at $1.01-1.5 \times I_N$									
F2 AC 60/50Hz trip at $1.01-1.5 \times I_N$									
<b>Characteristic curve K, short delay:</b>									
K1 DC trip time at $2 \times I_N$ : 0.16-1.2 s									
K2 AC 60/50Hz trip time at $2 \times I_N$ : 0.13-1.6 s									
<b>Characteristic curve M, medium delay:</b>									
M1 DC trip time at $2 \times I_N$ : 0.6-7.5 s									
M2 AC 60/50Hz trip time at $2 \times I_N$ : 2.2-20 s									
<b>Without characteristic curve:</b>									
Q0 switch only									
<b>Characteristic curve T, long delay:</b>									
T1 DC trip time at $2 \times I_N$ : 10-70 s									
T2 AC 60/50Hz trip time at $2 \times I_N$ : 15-150 s									
<b>Relay trip X:</b>									
X1 voltage trip at DC, instantaneous trip									
X2 voltage trip at AC, instantaneous trip									
<b>Other curves to special order</b> (e.g. pulse delayed, high inrush currents, capacitive loads)									
<b>Actuator colour / design</b>									
A black, long toggle									
B white, long toggle									
C blue, long toggle									
K black, short toggle									
L white, short toggle									
M blue, short toggle									
Z black, without toggle, with slot									
<b>other colours to special order</b>									
<b>Marking on actuator</b>									
0 without marking									
L I-O; ON-OFF									
N I-O; ON-OFF ( $I_N$ on housing top)									
<b>Auxiliary contacts</b>									
H0 without auxiliary contacts									
H1 with auxiliary contacts, gold-flushed									
H2 auxiliary contacts, gold-flushed on one pole only (multipole)									
H3 auxiliary contacts, gold-flushed on poles 1 and 3 (3 and 4-pole)									
<b>Auxiliary contact function</b>									
4 1 change over contact									
<b>Auxiliary contact terminal design</b>									
2 blade terminal 2.8-0.5 mm									
<b>Current ratings</b>									
0.02...50 A									

8340 - F 1 1 0 - P1 M1 - A L H1 4 2 - 30 A

8340 - F 1 1 0 - P1 M1 - A L H1 4 2 - 30 A									
<b>Voltage rating</b>									
only curves X1, X2									
DC 5, 8, 12, 24 V									
AC 110, 220, 240 V									
<b>Options</b>									
H higher flammability rating									
Approvals upon request									
<b>Approval (optional)</b>									
U UL 489 A									
8340 - F 1 1 0 - P1 M1 - A L H1 4 2 - 30 A - ... - ... - U ordering example									

**Homologations**

Authority	Voltage ratings	Current ratings
VDE (EN 60934)	3 AC 415 V; AC 240 V; DC 80 V	0.02...30 A 1 to 6-pole DC 80 V 0.02...50 A 1-pole
UL 1077, CSA	DC 80 V 3 AC 250 V; AC 250 V	0.02...50 A 1 to 6-pole 0.02...30 A 1 to 6-pole
UL 489 A	DC 80 V	0.05...30 A 1, 2-pole
QPL (Sweden)	AC 240 V; DC 50 V	1...30 A
CCC	3 AC 415 V; AC 240 V DC 80 V	0.02...30 A 0.02...50 A 1, 2-pole

**Internal connection diagrams**

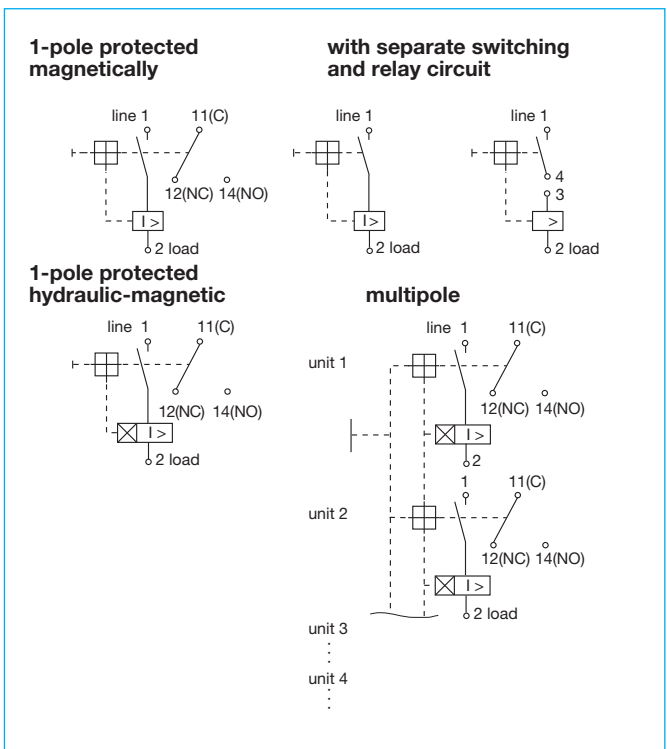

Dimensions

**Flange mounting  
Configuration: F1/F4**

Actuator: long toggle

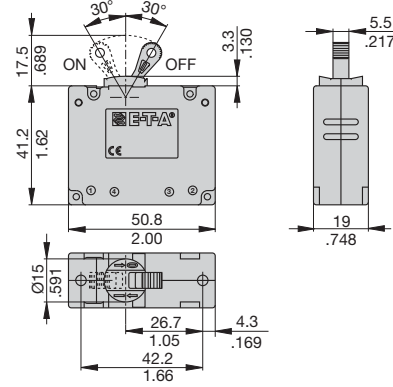

Actuator: short toggle

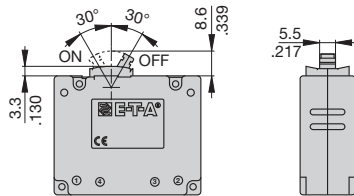

Actuator: without toggle, with slot

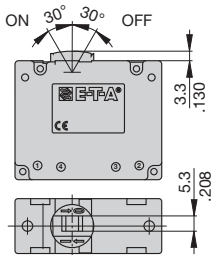

Applicable for nominal dimensions without direct tolerance indication:  
DIN ISO 286 ± IT13

number of poles: 1-4

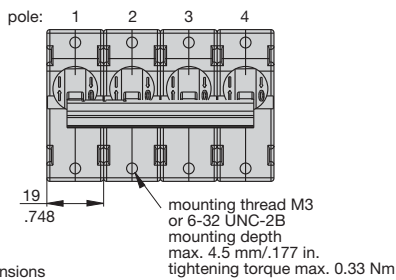

Cut-out dimensions  
max. panel thickness: 3 mm

- 3.5<sup>+0.1</sup> (M3)
- 4<sup>+0.1</sup><sub>-0.15</sub> (6-32UNC)
- .138<sup>-0.004</sup> (M3)
- .157<sup>-0.006</sup> (6-32UNC)

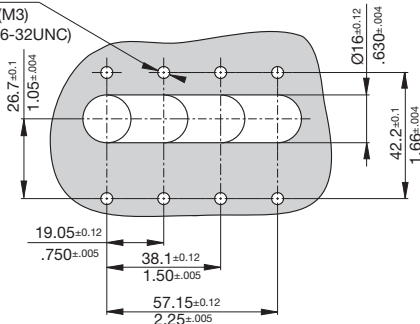

**Configuration: F9**

Actuator: long toggle

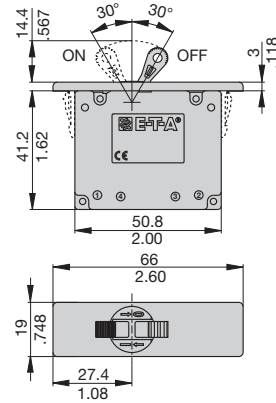

Actuator: short toggle

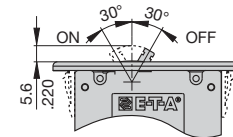

Actuator: without toggle, with slot

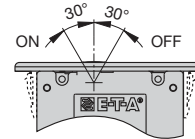

number of poles: 1-4

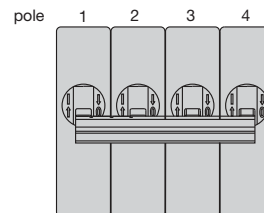

Cut-out dimensions  
max. panel thickness: 2 ± 0.5 mm

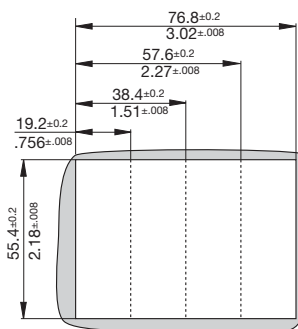

Applicable for nominal dimensions without direct tolerance indication:  
DIN ISO 286 ± IT13

This is a metric design and millimeter dimensions take precedence (mm/inch)

**Terminal design / Dimensions**

**K3/4 screw terminals**  
tightening torque max. 1.2 Nm

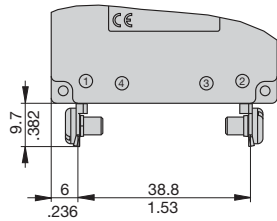

**K3 screw terminals M4**  
**K4 screw terminals M5**

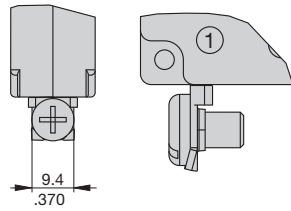

**P1 blade terminals**

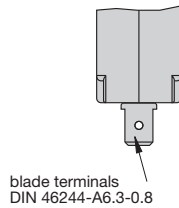
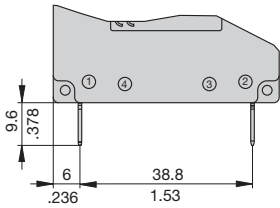

**X1 blade terminals**  
with separate switching and relay circuit

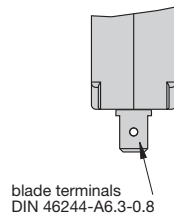
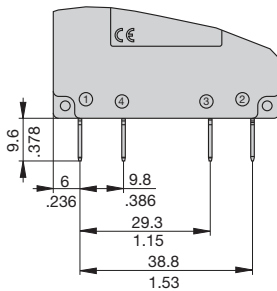

**Auxiliary contacts**  
version H (standard, asymmetrical gold-flushed terminals, silver contacts)

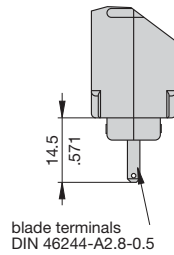
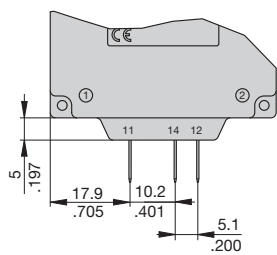

**Actuator configuration**

**Actuator design**

number of poles: 1 - 4  
Configuration: F1 / F4

Actuator long

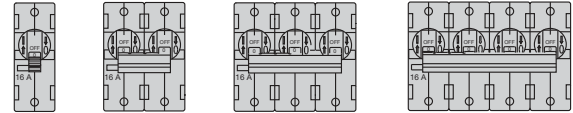

Actuator short

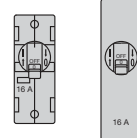

number of poles: 1 - 4  
Configuration: F9

Actuator long

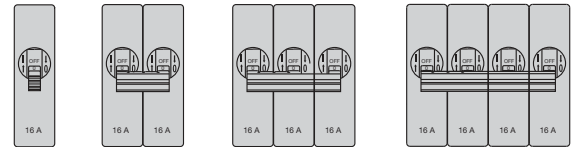

number of poles: 1  
Configuration: F1 / F4 / F9

Actuator: Z (black, without toggle, with slot)

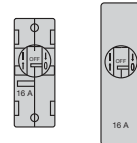

**Installation drawing**

**Terminal design K**

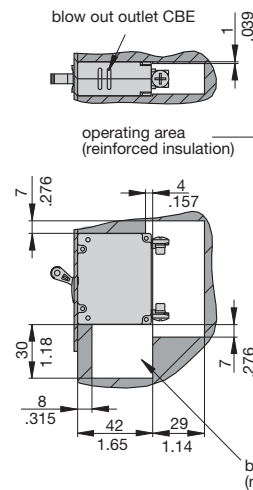

**Terminal design P**

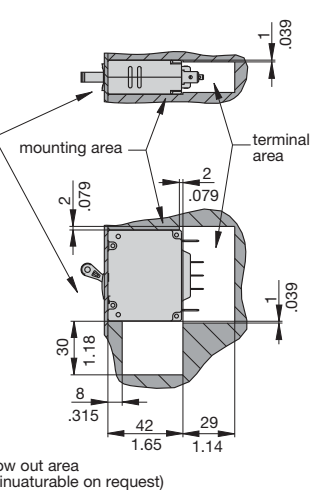

Trip time values indicated for front mounting on a vertical even surface

This is a metric design and millimeter dimensions take precedence (mm/inch)

Typical time/current characteristics at 23 °C / +73.4 °F

**Curve F1 (instantaneous) for DC**

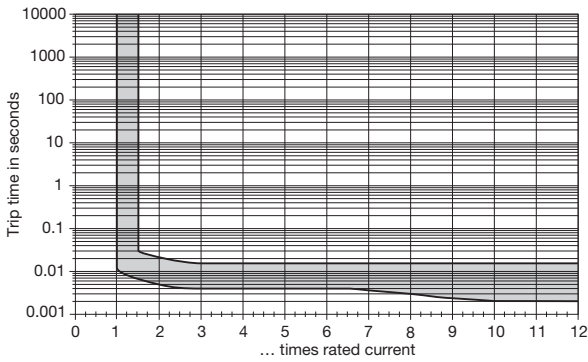

**Curve M0 (medium delay) for AC/DC**

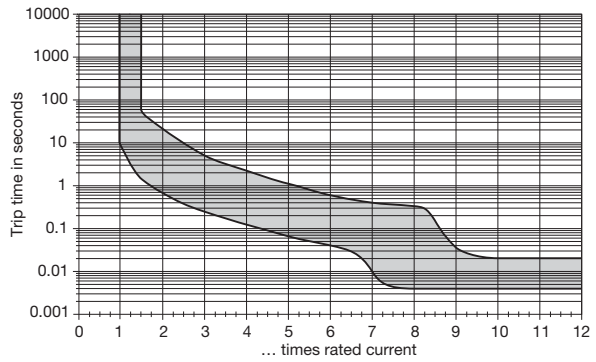

**Curve F2 (instantaneous) for AC 50/60 Hz**

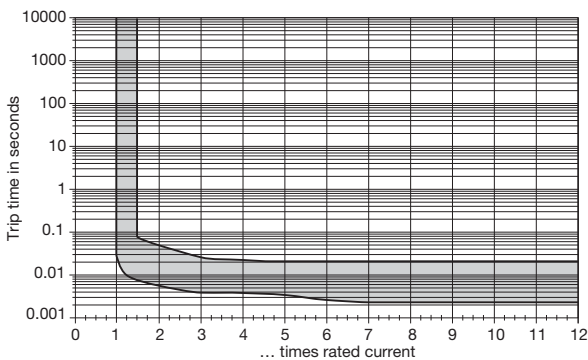

**Curve M1 (medium delay) for DC**

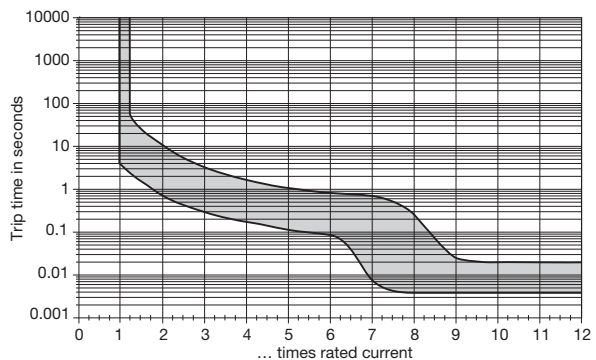

**Curve K1 (short delay) for DC**

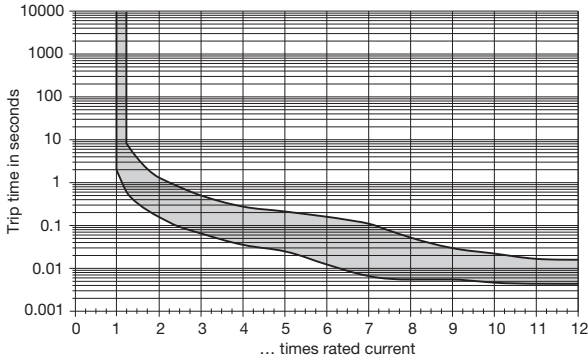

**Curve M2 (medium delay) for AC 50/60 Hz**

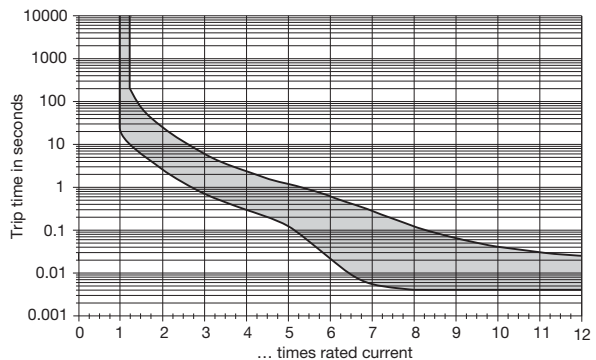

**Curve K2 (short delay) for AC 50/60 Hz**

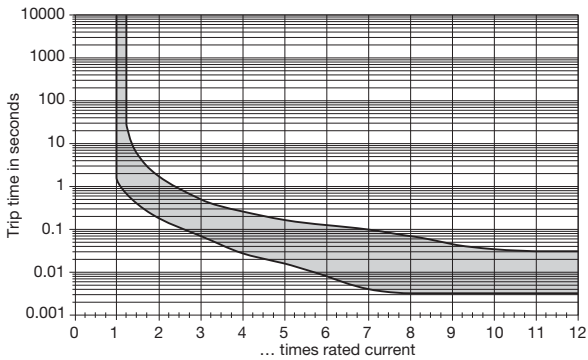

**N.B.** All curves will only be maintained if the escutcheon is mounted on a vertical surface.  
**Other characteristic curves to special order (e. g. with impulse delay for inrush peaks).**

Typical time/current characteristics at 23 °C / +73.4 °F

Curve T1 (long delay) for DC

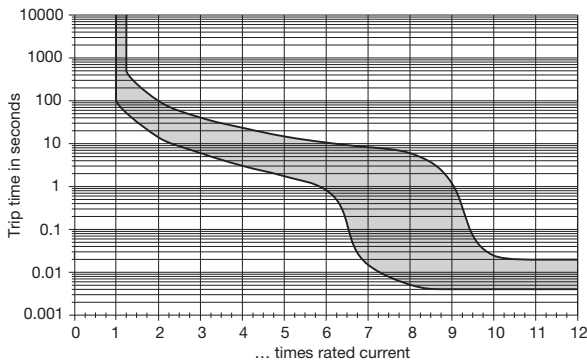

Curve T2 (long delay) for AC 50/60 Hz

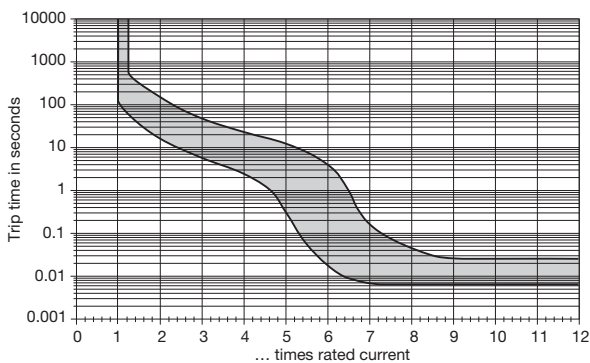

**N.B.** All curves will only be maintained if the escutcheon is mounted on a vertical surface.

Other characteristic curves to special order (e. g. with impulse delay for inrush peaks).

Shock directions / Mounting attitudes

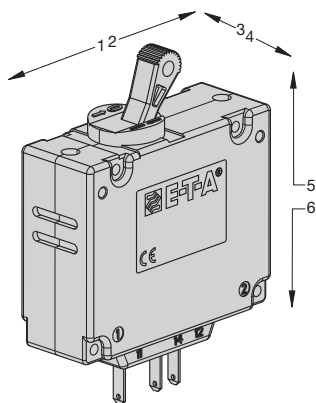

Accessories

Splash cover with mounting plate and screws

1 pole  
Y 303 565 01

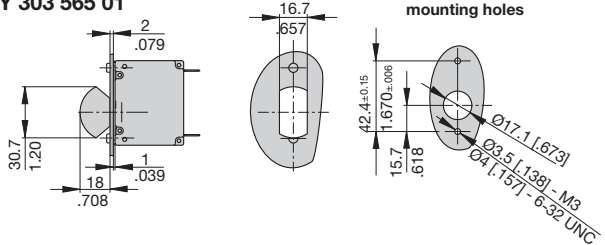

2 pole  
X 211 118 01

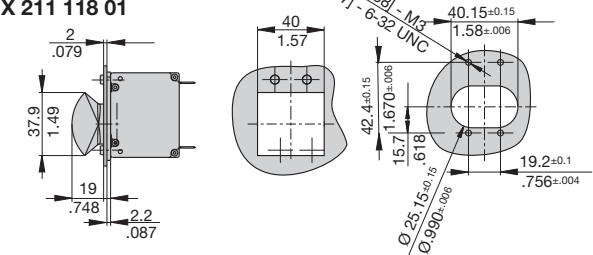

3 pole  
X 211 119 01

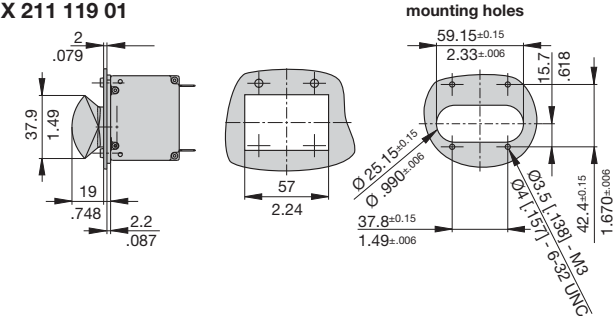

Toggle guard  
Y 307 250 01

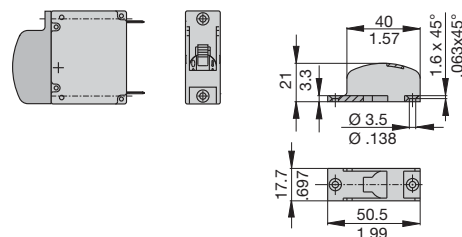

This is a metric design and millimeter dimensions take precedence (mm/inch)

All dimensions without tolerances are for reference only. In the interest of improved design, performance and cost effectiveness the right to make changes in these specifications without notice is reserved. Product markings may not be exactly as the ordering codes. Errors and omissions excepted.