

# QH05TZ600, QH05BZ600

## Qspeed™ Family

600 V, 5 A H-Series PFC Diode

### Product Summary

$I_{F(AVG)}$	5	A
$V_{RRM}$	600	V
$Q_{RR}$ (Typ at 125 °C)	18.9	nC
$I_{RRM}$ (Typ at 125 °C)	1.59	A
Softness $t_B/t_A$ (Typ at 125 °C)	0.86	

### Pin Assignment

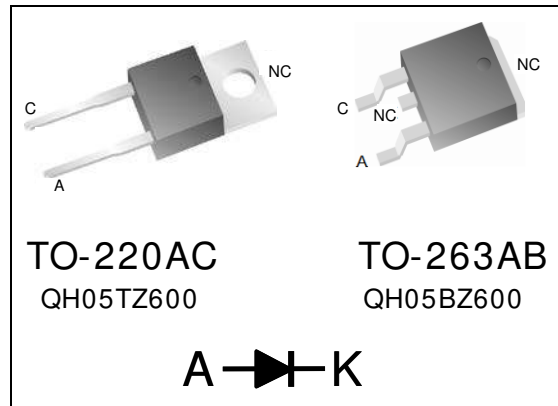

### RoHS Compliant

Package uses Lead-free plating and Green mold compound.  
Halogen free per IEC 61249-2-21.

### General Description

This device has the lowest  $Q_{RR}$  of any 600 V silicon diode. Its recovery characteristics increase efficiency, reduce EMI and eliminate snubbers.

### Applications

- Power Factor Correction (PFC) boost diode
- Motor drive circuits
- DC-AC inverters

### Features

- Low  $Q_{RR}$ , low  $I_{RRM}$ , low  $t_{RR}$
- High  $dI_F/dt$  capable (1000 A /  $\mu$ s)
- Soft recovery

### Benefits

- Increases efficiency
  - Eliminates need for snubber circuits
  - Reduces EMI filter component size & count
- Enables extremely fast switching

### Absolute Maximum Ratings

Absolute maximum ratings are the values beyond which the device may be damaged or have its useful life impaired. Functional operation under these conditions is not implied.

Symbol	Parameter	Conditions	Rating	Units
$V_{RRM}$	Peak repetitive reverse voltage	$T_J = 25\text{ °C}$	600	V
$I_{F(AVG)}$	Average forward current	$T_J = 150\text{ °C}, T_C = 109\text{ °C}$	5	A
$I_{FSM}$	Non-repetitive peak surge current	60 Hz, 1/2 cycle, $T_C = 25\text{ °C}$	50	A
$I_{FSM}$	Non-repetitive peak surge current	1/2 cycle of $t = 28\text{ }\mu$ s Sinusoid, $T_C = 25\text{ °C}$	350	A
$T_J$	Operating junction temperature range		-55 to 150	°C
$T_{STG}$	Storage temperature		-55 to 150	°C
	Lead soldering temperature	Leads at 1.6 mm from case, 10 sec	300	°C
$V_{ISOL}$	Isolation voltage (leads-to-tab)	AC, TO-220	2500	V
$V_{ISOL}$	Isolation voltage (leads-to-tab)	AC, TO-263	1500	V
$P_D$	Power dissipation	$T_C = 25\text{ °C}$	36.8	W

## Thermal Resistance

Symbol	Resistance from:	Conditions	Rating	Units
$R_{\theta JA}$	Junction to ambient	TO-220 (only)	62	$^{\circ}\text{C}/\text{W}$
$R_{\theta JC}$	Junction to case		3.4	$^{\circ}\text{C}/\text{W}$

## Electrical Specifications at $T_J = 25\text{ }^{\circ}\text{C}$ (unless otherwise specified)

Symbol	Parameter	Conditions	Min	Typ	Max	Units	
<b>DC Characteristics</b>							
$I_R$	Reverse current	$V_R = 600\text{ V}, T_J = 25\text{ }^{\circ}\text{C}$	-	-	250	$\mu\text{A}$	
		$V_R = 600\text{ V}, T_J = 125\text{ }^{\circ}\text{C}$	-	0.31	-	$\text{mA}$	
$V_F$	Forward voltage	$I_F = 5\text{ A}, T_J = 25\text{ }^{\circ}\text{C}$	-	2.6	3.1	$\text{V}$	
		$I_F = 5\text{ A}, T_J = 150\text{ }^{\circ}\text{C}$	-	2.2	-	$\text{V}$	
$C_J$	Junction capacitance	$V_R = 10\text{ V}, 1\text{ MHz}$	-	17	-	$\text{pF}$	
<b>Dynamic Characteristics</b>							
$t_{RR}$	Reverse recovery time	$dI/dt = 200\text{ A}/\mu\text{s}$ $V_R = 400\text{ V}, I_F = 5\text{ A}$	$T_J = 25\text{ }^{\circ}\text{C}$	-	10	-	$\text{ns}$
			$T_J = 125\text{ }^{\circ}\text{C}$	-	17.4	-	$\text{ns}$
$Q_{RR}$	Reverse recovery charge	$dI/dt = 200\text{ A}/\mu\text{s}$ $V_R = 400\text{ V}, I_F = 5\text{ A}$	$T_J = 25\text{ }^{\circ}\text{C}$	-	6.5	12	$\text{nC}$
			$T_J = 125\text{ }^{\circ}\text{C}$	-	18.9	-	$\text{nC}$
$I_{RRM}$	Maximum reverse recovery current	$dI/dt = 200\text{ A}/\mu\text{s}$ $V_R = 400\text{ V}, I_F = 5\text{ A}$	$T_J = 25\text{ }^{\circ}\text{C}$	-	1.0	1.55	$\text{A}$
			$T_J = 125\text{ }^{\circ}\text{C}$	-	1.59	-	$\text{A}$
S	Softness factor = $\frac{t_B}{t_A}$	$dI/dt = 200\text{ A}/\mu\text{s}$ $V_R = 400\text{ V}, I_F = 5\text{ A}$	$T_J = 25\text{ }^{\circ}\text{C}$	-	0.8	-	
			$T_J = 125\text{ }^{\circ}\text{C}$	-	0.86	-	

**Note to component engineers:** H-Series diodes employ Schottky technologies in their design and construction. Therefore, Component Engineers should plan their test setups to be similar to those for traditional Schottky test setups. (For additional details, see Application Note AN-300.)

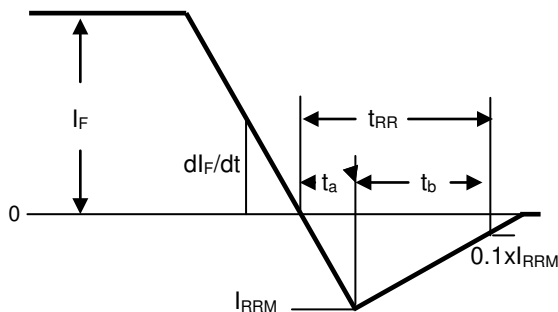
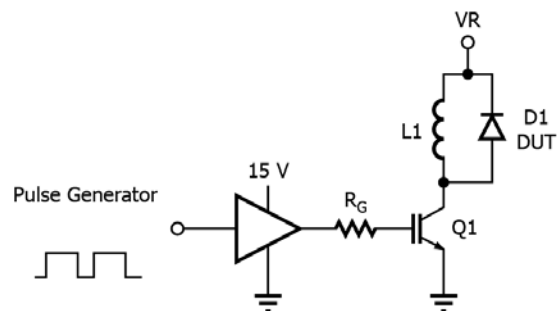

Figure 1. Reverse Recovery Definitions.



PI-7614-041315

Figure 2. Reverse Recovery Test Circuit.

Electrical Specifications at  $T_J = 25\text{ }^\circ\text{C}$  (unless otherwise specified)

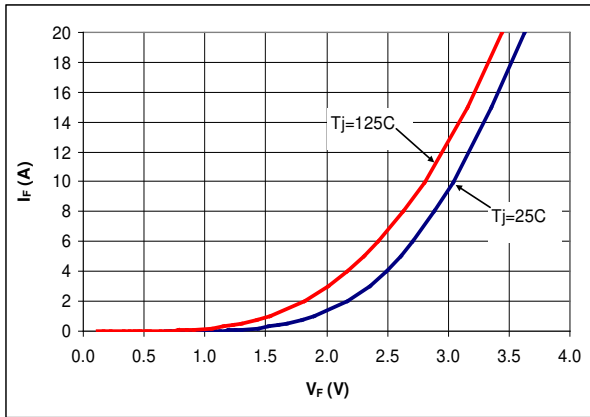

Figure 3. Typical  $I_F$  vs.  $V_F$ .

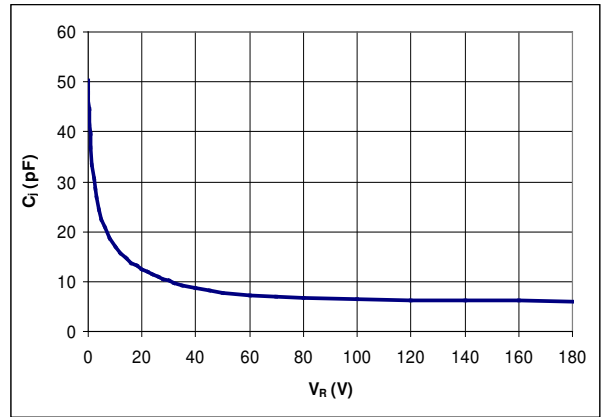

Figure 4. Typical  $C_J$  vs.  $V_R$ .

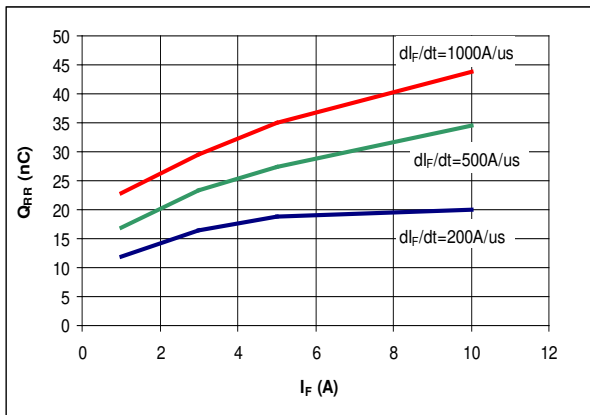

Figure 5. Typical  $Q_{RR}$  vs.  $I_F$  at  $T_J = 125\text{ }^\circ\text{C}$ .

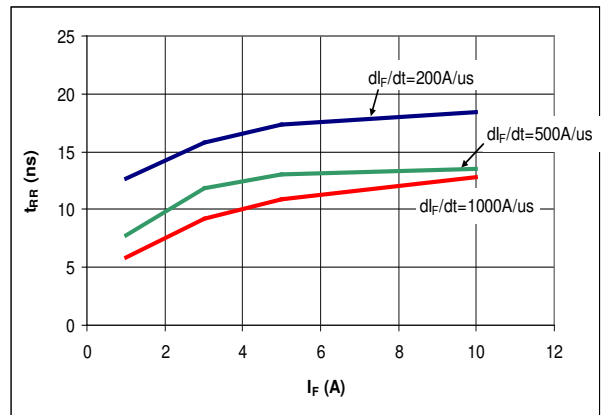

Figure 6. Typical  $t_{RR}$  vs.  $I_F$  at  $T_J = 125\text{ }^\circ\text{C}$ .

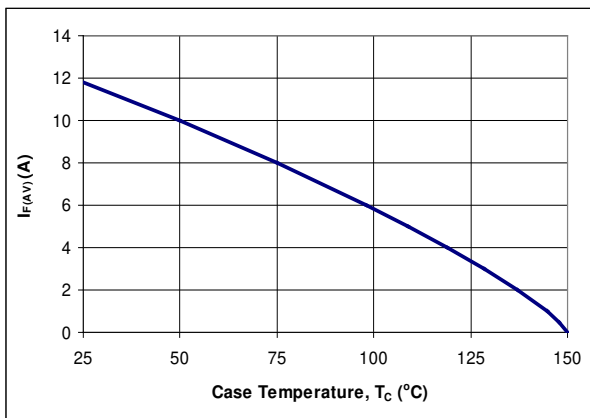

Figure 7. DC Current Derating Curve.

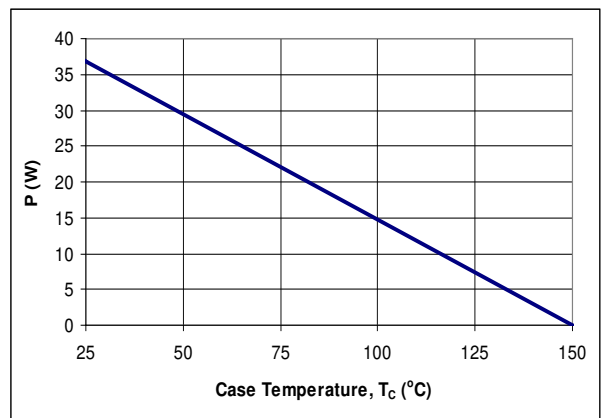

Figure 8. Power Derating Curve.

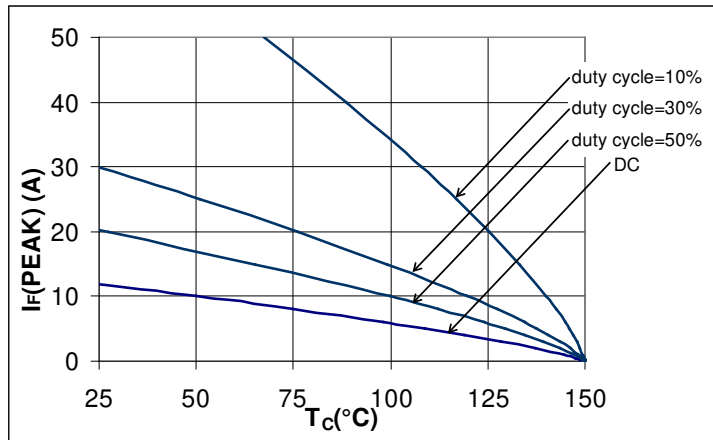

Figure 9.  $I_F$ (PEAK) vs.  $T_C$ ,  $f = 70$  kHz.

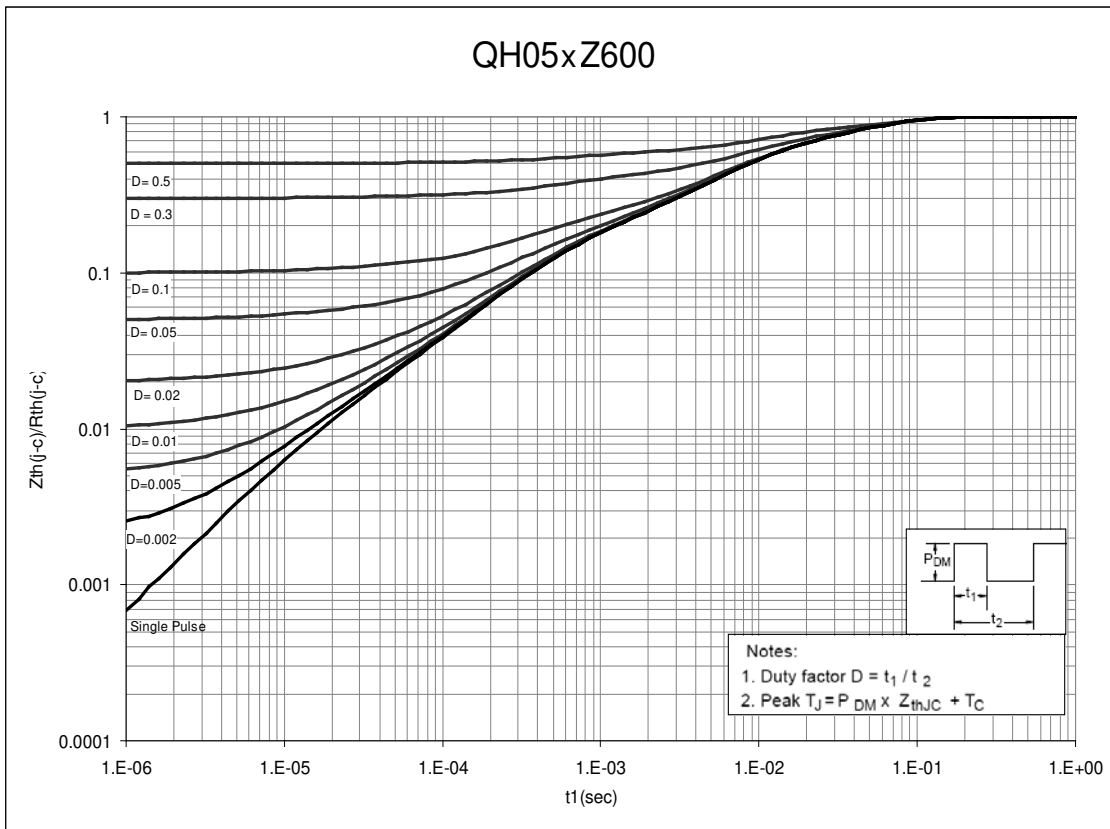
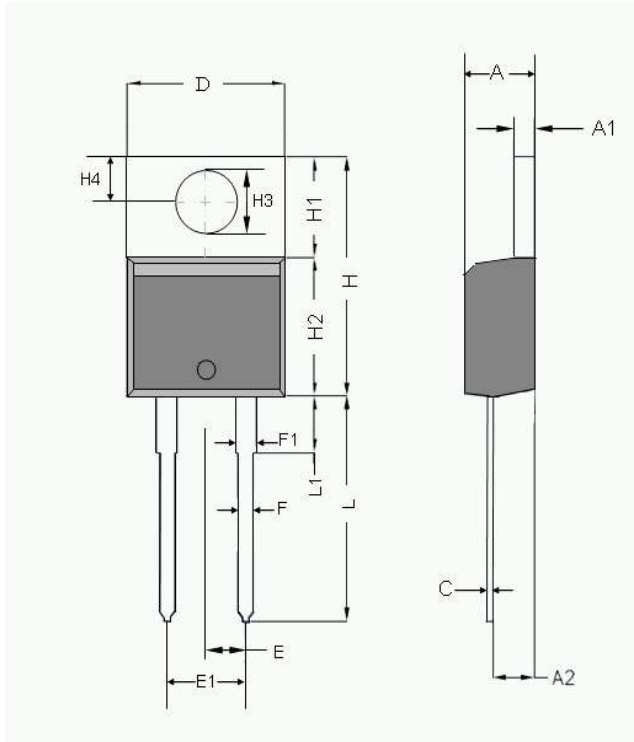

Figure 10. Normalized Maximum Transient Thermal Impedance.

## Dimensional Outline Drawings

TO-220AC



Dim	Millimeters	
	MIN	MAX
A	4.32	4.70
A1	1.14	1.40
A2	2.03	2.79
C	0.34	0.610
D	9.65	10.67
E	2.49	2.59
E1	4.98	5.18
F	0.508	1.016
F1	1.14	1.78
H	14.71	16.51
H1	5.84	6.795
H2	8.40	9.00
H3	3.53	3.96
H4	2.54	3.05
L	12.70	14.22
L1	-	6.35

## Dimensional Outline Drawings

TO-263AB

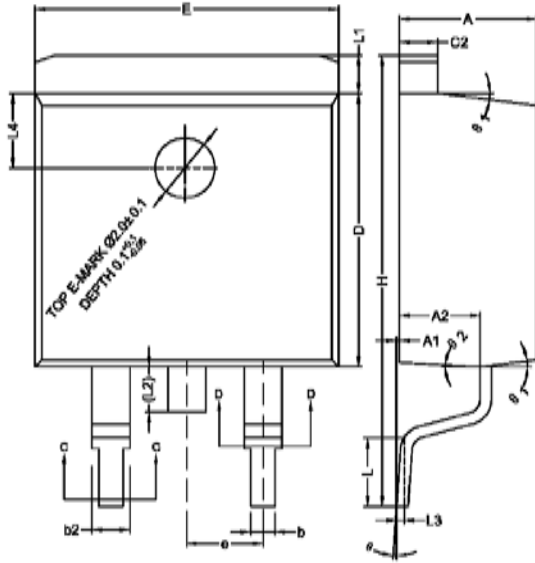

Dim	Millimeters	
	MIN	MAX
A	4.40	4.70
A1	0.00	0.25
A2	2.59	2.79
b	0.77	0.90
b2	1.23	1.36
c2	1.22	1.32
D	9.05	9.25
E	10.06	10.26
e	2.54 BSC	2.54 BSC
H	14.70	15.50
L	2.00	2.60
L1	1.17	1.40
L2	–	1.75
L3	0.25 BSC	0.25 BSC
L4	2.00 BSC	2.00 BSC
$\theta$	0°	8°
$\theta 1$	5°	9°
$\theta 2$	1°	5°

Mechanical Mounting Method	Maximum Torque / Pressure specification
Screw through hole in package tab	1 Newton Meter (nm) or 8.8 inch-pounds (lb-in)
Clamp against package body	12.3 kilogram-force per square centimeter (kgf/cm <sup>2</sup> ) or 175 lbf/in <sup>2</sup>

## Footprint and Solder Pad Dimensions

Pad Dimensions in mm:  
TO-263AB

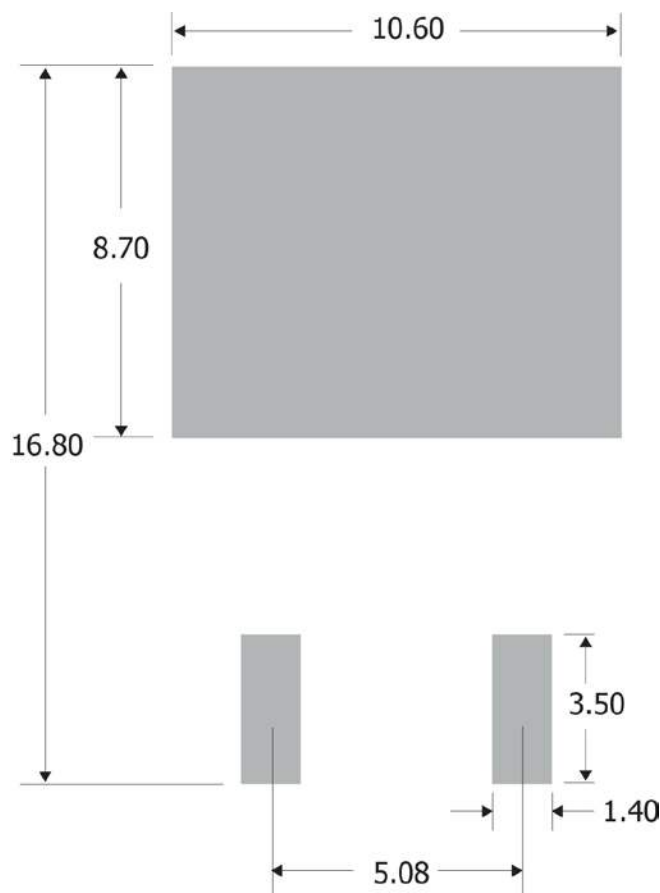

**Soldering time and temperature:** This product has been designed for use with high-temperature, lead-free solder. The component leads can be subjected to a maximum temperature of 300 °C, for up to 10 seconds. See Application Note AN-303, for more details.

## Ordering Information

Part Number	Package	Packing
QH05TZ600	TO-220AC	50 units/tube
QH05BZ600	TO-263AB	800 units/reel

The information contained in this document is subject to change without notice.

---

Revision	Notes	Date
1.0	Released by Qspeed	01/10
1.1	Converted to Power Integrations Document	01/11
1.2	Added QH05BZ600	02/13
1.3	Updated with new Brand Style. Added footprint and solder pad dimension for TO-263AB package.	11/15



For the latest updates, visit our website: [www.power.com](http://www.power.com)

Power Integrations reserves the right to make changes to its products at any time to improve reliability or manufacturability. Power Integrations does not assume any liability arising from the use of any device or circuit described herein. POWER INTEGRATIONS MAKES NO WARRANTY HEREIN AND SPECIFICALLY DISCLAIMS ALL WARRANTIES INCLUDING, WITHOUT LIMITATION, THE IMPLIED WARRANTIES OF MERCHANTABILITY, FITNESS FOR A PARTICULAR PURPOSE, AND NON-INFRINGEMENT OF THIRD PARTY RIGHTS.

#### Patent Information

The products and applications illustrated herein (including transformer construction and circuits' external to the products) may be covered by one or more U.S. and foreign patents, or potentially by pending U.S. and foreign patent applications assigned to Power Integrations. A complete list of Power Integrations' patents may be found at [www.power.com](http://www.power.com). Power Integrations grants its customers a license under certain patent rights as set forth at <http://www.power.com/ip.htm>.

#### Life Support Policy

POWER INTEGRATIONS PRODUCTS ARE NOT AUTHORIZED FOR USE AS CRITICAL COMPONENTS IN LIFE SUPPORT DEVICES OR SYSTEMS WITHOUT THE EXPRESS WRITTEN APPROVAL OF THE PRESIDENT OF POWER INTEGRATIONS. As used herein:

1. A Life support device or system is one which, (i) is intended for surgical implant into the body, or (ii) supports or sustains life, and (iii) whose failure to perform, when properly used in accordance with instructions for use, can be reasonably expected to result in significant injury or death to the user.
2. A critical component is any component of a life support device or system whose failure to perform can be reasonably expected to cause the failure of the life support device or system, or to affect its safety or effectiveness.

The PI Logo, TOPSwitch, TinySwitch, LinkSwitch, LYTSwitch, InnoSwitch, DPA-Switch, PeakSwitch, CAPZero, SENZero, LinkZero, HiperPFS, HiperTFS, HiperLCS, Qspeed, EcoSmart, Clampless, E-Shield, Filterfuse, FluxLink, StackFET, PI Expert and PI FACTS are trademarks of Power Integrations, Inc. Other trademarks are property of their respective companies. © Copyright 2015 Power Integrations, Inc.

## Power Integrations Worldwide Sales Support Locations

#### WORLD HEADQUARTERS

5245 Hellyer Avenue  
San Jose, CA 95138, USA  
Main: +1-408-414-9200  
Customer Service:  
Phone: +1-408-414-9665  
Fax: +1-408-414-9765  
e-mail: [usasales@power.com](mailto:usasales@power.com)

#### GERMANY

Lindwurmstrasse 114  
80337, Munich  
Germany  
Phone: +49-895-527-39110  
Fax: +49-895-527-39200  
e-mail: [eurosales@power.com](mailto:eurosales@power.com)

#### JAPAN

Kosei Dai-3 Building  
2-12-11, Shin-Yokohama,  
Kohoku-ku  
Yokohama-shi, Kanagawa  
222-0033 Japan  
Phone: +81-45-471-1021  
Fax: +81-45-471-3717  
e-mail: [japansales@power.com](mailto:japansales@power.com)

#### TAI WAN

5F, No. 318, Nei Hu Rd.,  
Sec. 1  
Nei Hu District  
Taipei 11493, Taiwan R.O.C.  
Phone: +886-2-2659-4570  
Fax: +886-2-2659-4550  
e-mail: [taiwansales@power.com](mailto:taiwansales@power.com)

#### CHINA (SHANGHAI)

Rm 2410, Charity Plaza, No. 88,  
North Caoxi Road,  
Shanghai, PRC 200030  
Phone: +86-21-6354-6323  
Fax: +86-21-6354-6325  
e-mail: [chinasales@power.com](mailto:chinasales@power.com)

#### INDIA

# 1, 14<sup>th</sup> Main Road  
Vasanthanagar  
Bangalore-560052  
India  
Phone: +91-80-4113-8020  
Fax: +91-80-4113-8023  
e-mail: [indiasales@power.com](mailto:indiasales@power.com)

#### KOREA

RM 602, 6FL  
Korea City Air Terminal B/D,  
159-6  
Samsung-Dong, Kangnam-Gu,  
Seoul, 135-728 Korea  
Phone: +82-2-2016-6610  
Fax: +82-2-2016-6630  
e-mail: [koreasales@power.com](mailto:koreasales@power.com)

#### UK

Cambridge Semiconductor,  
a Power Integrations company  
Westbrook Centre, Block 5,  
2nd Floor  
Milton Road  
Cambridge CB4 1YG  
Phone: +44 (0) 1223-446483  
e-mail: [eurosales@power.com](mailto:eurosales@power.com)

#### CHINA (SHENZHEN)

17/F, Hivac Building, No. 2, Keji  
Nan 8th Road, Nanshan District,  
Shenzhen, China, 518057  
Phone: +86-755-8672-8689  
Fax: +86-755-8672-8690  
e-mail: [chinasales@power.com](mailto:chinasales@power.com)

#### ITALY

Via Milanese 20, 3<sup>rd</sup> Fl.  
20099 Sesto San Giovanni  
(MI) Italy  
Phone: +39-024-550-8701  
Fax: +39-028-928-6009  
e-mail: [eurosales@power.com](mailto:eurosales@power.com)

#### SINGAPORE

51 Newton Road,  
# 19-01/05 Goldhill Plaza  
Singapore, 308900  
Phone: +65-6358-2160  
Fax: +65-6358-2015  
e-mail: [singaporesales@power.com](mailto:singaporesales@power.com)