

## Frequency Timing Generator for Dual Server/Workstation Systems

### General Description

The ICS932S200 is a dual CPU clock generator for serverworks HE-T, HE-SL-T, LE-T chipsets for P III type processors in a Dual-CPU system. Single ended CPU clocks provide faster than 1.5V/ns transition times by parallel connection of 2 CPU pins to each processor.

Spread Spectrum may be enabled by driving the SPREAD# pin active. Spread spectrum typically reduces system EMI by 8dB to 10dB. This simplifies EMI qualification without resorting to board design iterations or costly shielding. The **ICS932S200** employs a proprietary closed loop design, which tightly controls the percentage of spreading over process and temperature variations.

### Key Specification:

- CPU Output Jitter: 150ps
- IOAPIC Output Jitter: 250ps
- 3V66, PCI Output Jitter: 250ps
- CPU Output Skew: <175ps
- PCI Output Skew: <500ps
- 3V66 Output Skew <250ps
- IOAPIC Output Skew <250ps
- CPU to 3V66 Output Offset: 0 - 1.5ns (CPU leads)
- CPU to PCI Output Offset: 1.5 - 4.0ns (CPU leads)
- CPU to APIC Output Offset: 1.5 - 4.0ns (CPU leads)

### Block Diagram

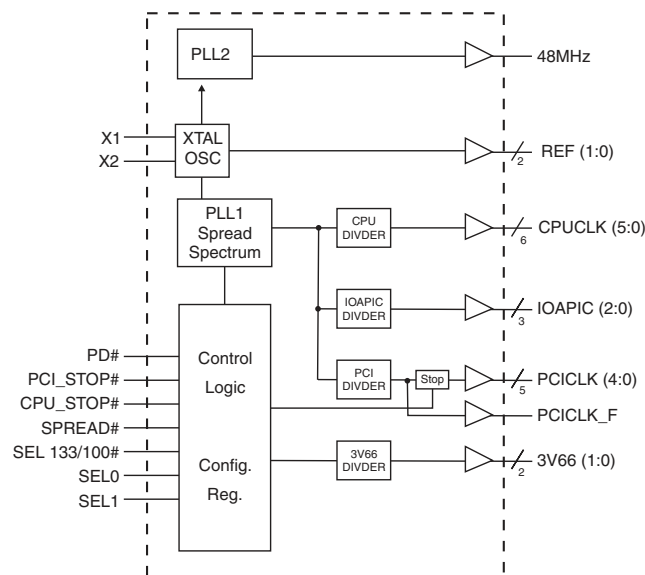

### Features

- Generates the following system clocks:
  - 6 CPU clocks ( 2.5V, 100/133MHz)
  - 6 PCI clocks, including 1 free running(3.3V, 33MHz)
  - 3 IOAPIC clocks (2.5V, 16.67MHz)
  - 2 Fixed frequency 66MHz clocks(3.3V, 66MHz)
  - 2 REF clocks(3.3V, 14.318MHz)
  - 1 USB clock (3.3V, 48MHz)
- Efficient power management through PD#, CPU\_STOP# and PCI\_STOP#.
- 0.5% typical down spread modulation on CPU, PCI, IOAPIC and 3V66 output clocks.
- Uses external 14.318MHz crystal.

### Pin Configuration

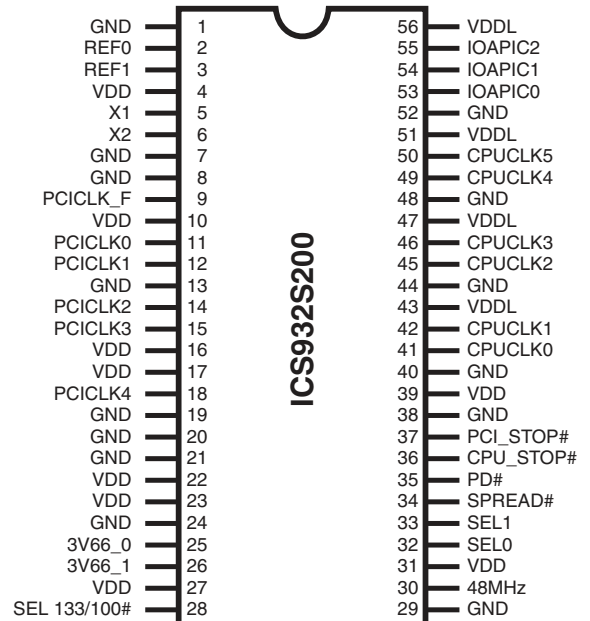

**56-pin 300 mil SSOP**  
**56-pin 240 mil TSSOP**

## Pin Descriptions

Pin number	Pin name	Type	Description
1, 7, 8, 13, 19 20, 21, 24, 29, 38, 40, 44, 48, 52	GND	PWR	Gnd pins
3, 2	REF(1:0)	OUT	14.318MHz reference clock outputs at 3.3V
4, 10, 16, 17, 22, 23, 27, 31, 39	VDD	PWR	Power pins 3.3V
5	X1	IN	XTAL_IN 14.318MHz crystal input
6	X2	OUT	XTAL_OUT Crystal output
9	PCICLK_F	OUT	Free running PCI clock not affected by PCI_STOP#
18, 15, 14, 12, 11	PCICLK (4:0)	OUT	PCI clock outputs at 3.3V. Synchronous to CPU clocks.
26, 25	3V66 (1:0)	OUT	66MHz outputs at 3.3V. These outputs are stopped when CPU_STOP# is driven active..
28	SEL 133/100#	IN	This selects the frequency for the CPU and CPU/2 outputs. High = 133MHz, Low=100MHz
30	48MHz	OUT	Fixed 48MHz clock output. 3.3V
33, 32	SEL (1:0)	IN	Function select pins. See truth table for details.
34	SPREAD#	IN	Enables spread spectrum when active(Low). modulates all the CPU, PCI, IOAPIC and 3V66 clocks. Does not affect the REF and 48MHz clocks. 0.5% down spread modulation.
35	PD#	IN	This asynchronous input powers down the chip when drive active(Low). The internal PLLs are disabled and all the output clocks are held at a Low state.
36	CPU_STOP#	IN	This asynchronous input halts the CPUCLK and the 3V66 clocks at logic "0" when driven active(Low).
37	PCI_STOP#	IN	This asynchronous input halts the PCICLK at logic"0" when driven active(Low). PCICLK_F is not affected by this input.
43, 47, 51, 56	VDDL	PWR	Power pins 2.5V
50, 49, 46, 45, 42, 41	CPUCLK (5:0)	OUT	Host bus clock output at 2.5V. 133MHz or 100MHz depending on the state of the SEL 133/100MHz.
55, 54, 53	IOAPIC (2:0)	OUT	IOAPIC clocks at 2.5V. Synchronous with CPUCLKs but fixed at 16.67MHz.

## Frequency Select:

SEL 133/100#	SEL1	SEL0	CPU MHz	3V66 MHz	PCI MHz	48 MHz	REF MHz	IOAPIC MHz	Comments
0	0	0	Hi-Z	Hi-Z	Hi-Z	Hi-Z	Hi-Z	Hi-Z	Tri-state
0	0	1	N/A	N/A	N/A	N/A	N/A	N/A	Reserved
0	1	0	100	66.6	33.3	Hi-Z	14.318	16.67	48MHz PLL disabled
0	1	1	100	66.6	33.3	48.0	14.318	16.67	
1	0	0	TCLK/2	TCLK/4	TCLK/8	TCLK/2	TCLK	TCLK/16	Test mode (1)
1	0	1	N/A	N/A	N/A	N/A	N/A	N/A	Reserved
1	1	0	133	66.6	33.3	Hi-Z	14.318	16.67	
1	1	1	133	66.6	33.3	48.0	14.318	16.67	

**Note:**

1. TCLK is a test clock driven on the x1 input during test mode.

## ICS932S200 Power Management Features:

CPU_STOP#	PD#	PCI_STOP#	CPUCLK	IOAPIC	3V66	PCI	PCI_F	REF. 48MHz	Osc	VCOs
X	0	X	LOW	LOW	LOW	LOW	LOW	LOW	OFF	OFF
0	1	0	LOW	ON	LOW	LOW	ON	ON	ON	ON
0	1	1	LOW	ON	LOW	ON	ON	ON	ON	ON
1	1	0	ON	ON	ON	LOW	ON	ON	ON	ON
1	1	1	ON	ON	ON	ON	ON	ON	ON	ON

**Note:**

1. LOW means outputs held static LOW as per latency requirement next page.
2. On means active.
3. PD# pulled Low, impacts all outputs including REF and 48 MHz outputs.
4. All 3V66 as well as all CPU clocks should stop cleanly when CPU\_STOP# is pulled LOW.
5. IOAPIC, REF, 48 MHz signals are not controlled by the CPU\_STOP# functionality and are enabled all in all conditions except PD# = LOW

## Power Management Requirements:

Signal	Signal State	Latency
		No. of rising edges of PCICLK
CPU_STOP	0 (disabled)	1
	1 (enabled)	1
PCI_STOP#	0 (disabled)	1
	1 (enabled)	1
PD#	1 (normal operation)	3mS
	0 (power down)	2max.

### Note:

1. Clock on/off latency is defined in the number of rising edges of free running PCICLKs between the clock disable goes low/high to the first valid clock comes out of the device.
2. Power up latency is when PWR\_DWN# goes inactive (high to when the first valid clocks are driven from the device).

## CPU\_STOP# Timing Diagram

CPU\_STOP# is an asynchronous input to the clock synthesizer. It is used to turn off the CPU and 3V66 clocks for low power operation. CPU\_STOP# is asserted asynchronously by the external clock control logic with the rising edge of free running PCI clock (and hence CPU clock) and must be internally synchronized to the external output. All other clocks will continue to run while the CPU clocks are disabled. The CPU clocks must always be stopped in a low state and started in such a manner as to guarantee that the high pulse width is a full pulse.

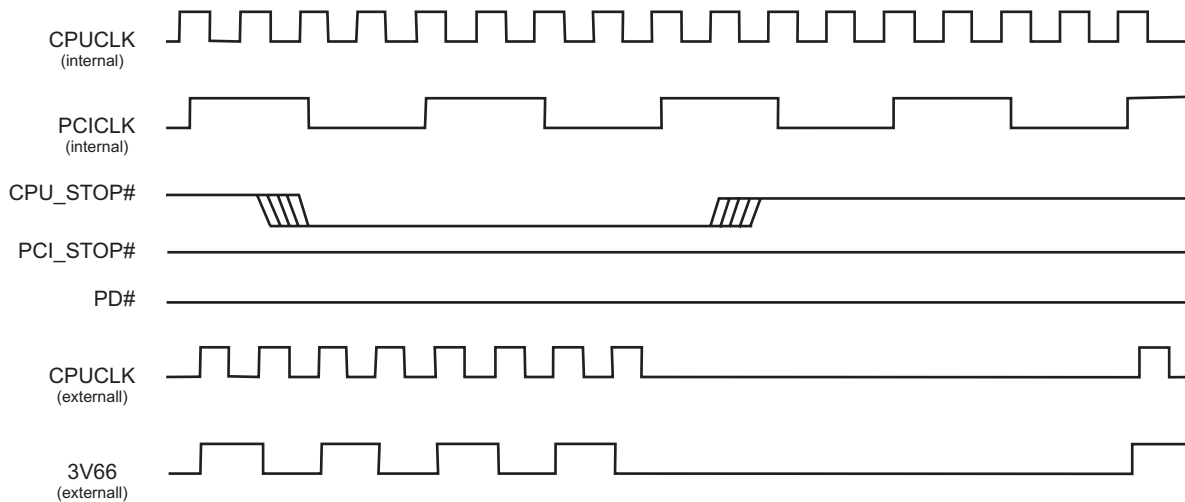

### Notes:

1. All timing is referenced to the internal CPUCLK.
2. The internal label means inside the chip and is a reference only. This in fact may not be the way that the control is designed.
3. 3V66 clocks also stop/start before
4. PD# and PCI\_STOP# are shown in a high state.
5. Diagrams shown with respect to 133MHz. Similar operation when CPU is 100MHz

## PCI\_STOP# Timing Diagram

PCI\_STOP# is an input to the clock synthesizer and must be made synchronous to the clock driver PCICLK\_F output. It is used to turn off the PCI clocks for low power operation. PCI clocks are required to be stopped in a low state and started such that a full high pulse width is guaranteed. **ONLY one rising edge of PCICLK\_F is allowed** after the clock control logic switched for the PCI outputs to become enabled/disabled.

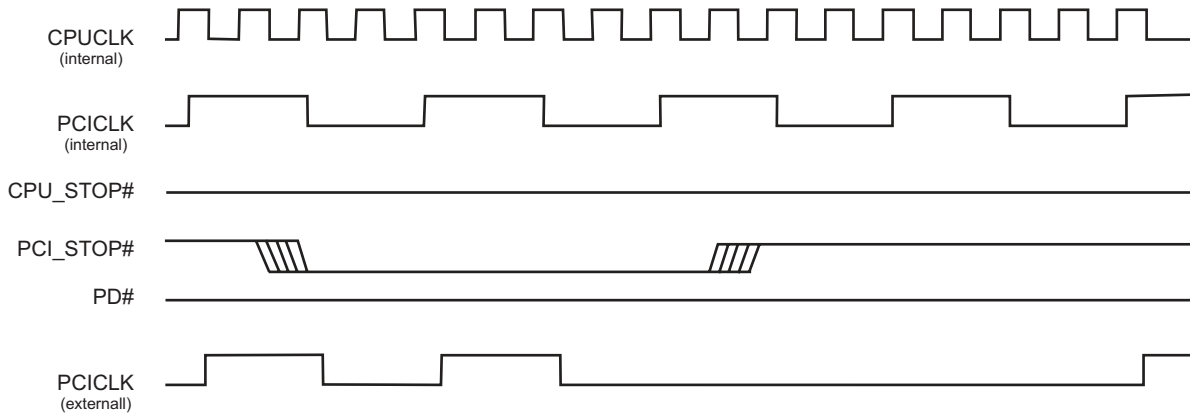

**Notes:**

1. All timing is referenced to CPUCLK.
2. Internal means inside the chip.
3. All other clocks continue to run undisturbed.
4. PD# and CPU\_STOP# are shown in a high state.
5. Diagrams shown with respect to 133MHz. Similar operation when CPU is 100MHz.

## PD# Timing Diagram

The power down selection is used to put the part into a very low power state without turning off the power to the part. PD# is an asynchronous active low input. This signal needs to be synchronized internal to the device prior to powering down the clock synthesizer.

Internal clocks are not running after the device is put in power down. When PD# is active low all clocks need to be driven to a low value and held prior to turning off the VCOs and crystal. The power up latency needs to be less than 3 mS. The power down latency should be as short as possible but conforming to the sequence requirements shown below. PCI\_STOP# and CPU\_STOP# are considered to be don't cares during the power down operations. The REF and 48MHz clocks are expected to be stopped in the LOW state as soon as possible. Due to the state of the internal logic, stopping and holding the REF clock outputs in the LOW state may require more than one clock cycle to complete.

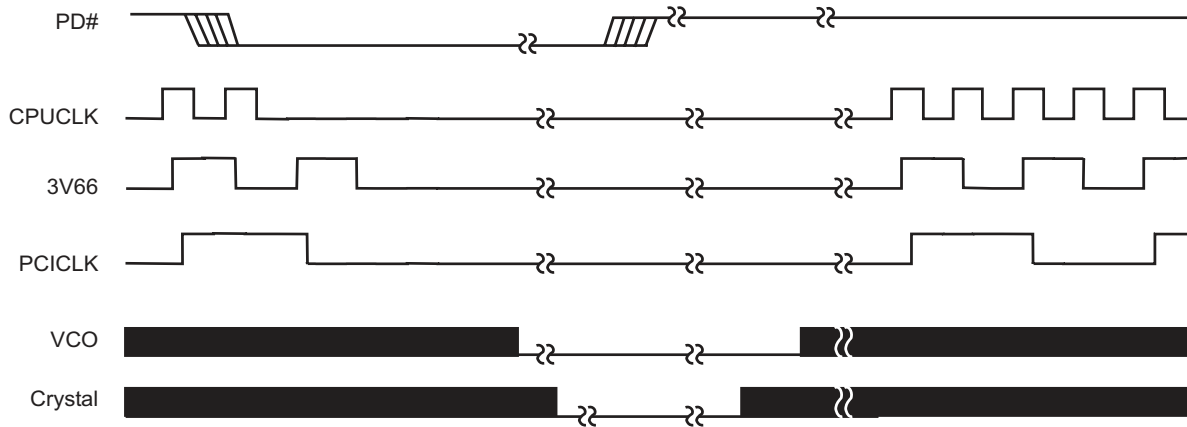

### Notes:

1. All timing is referenced to the Internal CPUCLK (defined as inside the ICS932S200 device).
2. As shown, the outputs Stop Low on the next falling edge after PD# goes low.
3. PD# is an asynchronous input and metastable conditions may exist. This signal is synchronized inside this part.
4. The shaded sections on the VCO and the Crystal signals indicate an active clock.
5. Diagrams shown with respect to 133MHz. Similar operation when CPU is 100MHz.

## Absolute Maximum Ratings

Supply Voltage	7.0 V
Logic Inputs	GND -0.5 V to $V_{DD} + 0.5$ V
Ambient Operating Temperature	0°C to +70°C
Storage Temperature	-65°C to +150°C

Stresses above those listed under *Absolute Maximum Ratings* may cause permanent damage to the device. These ratings are stress specifications only and functional operation of the device at these or any other conditions above those listed in the operational sections of the specifications is not implied. Exposure to absolute maximum rating conditions for extended periods may affect product reliability.

## Electrical Characteristics - Input/Supply/Common Output Parameters

$T_A = 0 - 70^\circ\text{C}$ ; Supply Voltage  $V_{DD} = 3.3\text{ V} \pm 5\%$ ,  $V_{DDL} = 2.5\text{ V} \pm 5\%$  (unless otherwise stated)

PARAMETER	SYMBOL	CONDITIONS	MIN	TYP	MAX	UNITS
Input High Voltage	$V_{IH}$		2		$V_{DD} + 0.3$	V
Input Low Voltage	$V_{IL}$		$V_{SS} - 0.3$		0.8	V
Input High Current	$I_{IH}$	$V_{IN} = V_{DD}$		0.1	5	$\mu\text{A}$
Input Low Current	$I_{IL1}$	$V_{IN} = 0\text{ V}$ ; Inputs with no pull-up resistors	-5	2.0		$\mu\text{A}$
Input Low Current	$I_{IL2}$	$V_{IN} = 0\text{ V}$ ; Inputs with pull-up resistors	-200	-100		$\mu\text{A}$
Operating Supply Current	$I_{DD3.3OP100}$	Select @ 100MHz; Max discrete cap loads		70	160	mA
	$I_{DD3.3OP133}$	Select @ 133MHz; Max discrete cap loads		80		
Power Down Supply Current	$I_{DD3.3PD}$	$C_L = 30\text{ pF}$ ; PWRDWN# = 0		102	200	$\mu\text{A}$
Input frequency	$F_i$	$V_{DD} = 3.3\text{ V}$	12	14.32	16	MHz
Input Capacitance <sup>1</sup>	$C_{IN}$	Logic Inputs			5	pF
	$C_{INX}$	X1 & X2 pins	27	36	45	pF
Transition Time <sup>1</sup>	$T_{Trans}$	To 1st crossing of target Freq.			3	ms
Settling Time <sup>1</sup>	$T_S$	From 1st crossing to 1% target Freq.		1		ms
Clk Stabilization <sup>1</sup>	$T_{Stab}$	From $V_{DD} = 3.3\text{ V}$ to 1% target Freq.			3	ms

<sup>1</sup>Guaranteed by design, not 100% tested in production.

## Electrical Characteristics - Input/Supply/Common Output Parameters

$T_A = 0 - 70^\circ\text{C}$ ; Supply Voltage  $V_{DD} = 3.3\text{ V} \pm 5\%$ ,  $V_{DDL} = 2.5\text{ V} \pm 5\%$  (unless otherwise stated)

PARAMETER	SYMBOL	CONDITIONS	MIN	TYP	MAX	UNITS
Operating Supply Current	$I_{DD2.5OP100}$	Select @ 100MHz; Max discrete cap loads		38	75	mA
	$I_{DD2.5OP133}$	Select @ 133MHz; Max discrete cap loads		69	90	

<sup>1</sup>Guaranteed by design, not 100% tested in production.

## Electrical Characteristics - CPUCLK

$T_A = 0 - 70^\circ\text{C}$ ;  $V_{DD} = 3.3\text{ V} \pm 5\%$ ,  $V_{DDL} = 2.5\text{ V} \pm 5\%$ ;  $C_L = 20\text{ pF}$  (unless otherwise stated)

PARAMETER	SYMBOL	CONDITIONS	MIN	TYP	MAX	UNITS
Output High Voltage	$V_{OH2B}$	$I_{OH} = -12.0\text{ mA}$	2	2.2		V
Output Low Voltage	$V_{OL2B}$	$I_{OL} = 12\text{ mA}$		0.3	0.4	V
Output High Current	$I_{OH2B}$	$V_{OH} = 1.7\text{ V}$		-35	-19	mA
Output Low Current	$I_{OL2B}$	$V_{OL} = 0.7\text{ V}$	19	27		mA
Rise Time	$t_{r2B}^1$	$V_{OL} = 0.4\text{ V}$ , $V_{OH} = 2.0\text{ V}$	0.4	0.84	1.6	ns
Fall Time	$t_{f2B}^1$	$V_{OH} = 2.0\text{ V}$ , $V_{OL} = 0.4\text{ V}$	0.4	0.81	1.6	ns
Duty Cycle	$d_{l2B}^1$	$V_T = 1.25\text{ V}$	45	50.7	55	%
Skew	$t_{sk2B}^1$	$V_T = 1.25\text{ V}$		93	175	ps
Jitter, Cycle-to-cycle	$t_{j\text{cyc-cyc}2B}^1$	$V_T = 1.25\text{ V}$		108	150	ps

<sup>1</sup>Guaranteed by design, not 100% tested in production.

## Electrical Characteristics - 3V66

$T_A = 0 - 70^\circ\text{C}$ ;  $V_{DD} = 3.3\text{ V} \pm 5\%$ ,  $V_{DDL} = 2.5\text{ V} \pm 5\%$ ;  $C_L = 30\text{ pF}$

PARAMETER	SYMBOL	CONDITIONS	MIN	TYP	MAX	UNITS
Output High Voltage	$V_{OH1}$	$I_{OH} = -11\text{ mA}$	2.4	3.1		V
Output Low Voltage	$V_{OL1}$	$I_{OL} = 9.4\text{ mA}$		0.25	0.4	V
Output High Current	$I_{OH1}$	$V_{OH} = 2.0\text{ V}$		-60	-22	mA
Output Low Current	$I_{OL1}$	$V_{OL} = 0.8\text{ V}$	25	44		mA
Rise Time <sup>1</sup>	$t_{r1}$	$V_{OL} = 0.4\text{ V}$ , $V_{OH} = 2.4\text{ V}$	0.5	1.44	2	ns
Fall Time <sup>1</sup>	$t_{f1}$	$V_{OH} = 2.4\text{ V}$ , $V_{OL} = 0.4\text{ V}$	0.5	1.24	2	ns
Duty Cycle <sup>1</sup>	$d_{t1}$	$V_T = 1.5\text{ V}$	45	48.2	55	%
Skew <sup>1</sup>	$t_{sk1}$	$V_T = 1.5\text{ V}$		83	250	ps
Jitter, Cycle-to-cycle <sup>1</sup>	$t_{j\text{cyc-cyc}1}$	$V_T = 1.5\text{ V}$		110	250	ps

<sup>1</sup>Guaranteed by design, not 100% tested in production.



## Electrical Characteristics - PCICLK

$T_A = 0 - 70^\circ\text{C}$ ;  $V_{DD} = 3.3\text{ V} \pm 5\%$ ,  $V_{DDL} = 2.5\text{ V} \pm 5\%$ ;  $C_L = 60\text{ pF}$  for PCI0 & PCI1,  $C_L = 30\text{ pF}$  for other PCIs

PARAMETER	SYMBOL	CONDITIONS	MIN	TYP	MAX	UNITS
Output High Voltage	$V_{OH1}$	$I_{OH} = -11\text{ mA}$	2.4	3.1		V
Output Low Voltage	$V_{OL1}$	$I_{OL} = 9.4\text{ mA}$		0.2	0.4	V
Output High Current	$I_{OH1}$	$V_{OH} = 2.0\text{ V}$		-60	-22	mA
Output Low Current	$I_{OL1}$	$V_{OL} = 0.8\text{ V}$	25	45		mA
Rise Time <sup>1</sup>	$t_{r1}$	$V_{OL} = 0.4\text{ V}$ , $V_{OH} = 2.4\text{ V}$	0.5	1.2	2	ns
Fall Time <sup>1</sup>	$t_{f1}$	$V_{OH} = 2.4\text{ V}$ , $V_{OL} = 0.4\text{ V}$	0.5	1.1	2	ns
Duty Cycle <sup>1</sup>	$d_{t1}$	$V_T = 1.5\text{ V}$	45	50.8	55	%
Skew <sup>1</sup>	$t_{sk1}$	$V_T = 1.5\text{ V}$		79	500	ps
Jitter, One Sigma <sup>1</sup>	$t_{j1\sigma1}$	$V_T = 1.5\text{ V}$			150	ps
Jitter, Absolute <sup>1</sup>	$t_{jabs1}$	$V_T = 1.5\text{ V}$	-250		250	ps
Jitter, Cycle-to-cycle <sup>1</sup>	$t_{j\text{cyc-cyc}1}$	$V_T = 1.5\text{ V}$		129	250	ps

<sup>1</sup>Guaranteed by design, not 100% tested in production.

## Electrical Characteristics - IOAPIC

$T_A = 0 - 70^\circ\text{C}$ ;  $V_{DD} = 3.3\text{ V} \pm 5\%$ ,  $V_{DDL} = 2.5\text{ V} \pm 5\%$ ;  $C_L = 20\text{ pF}$  (unless otherwise stated)

PARAMETER	SYMBOL	CONDITIONS	MIN	TYP	MAX	UNITS
Output High Voltage	$V_{OH4B}$	$I_{OH} = -12\text{ mA}$	2	2.23		V
Output Low Voltage	$V_{OL4B}$	$I_{OL} = 12\text{ mA}$		0.3	0.4	V
Output High Current	$I_{OH4B}$	$V_{OH} = 1.7\text{ V}$		-36	-16	mA
Output Low Current	$I_{OL4B}$	$V_{OL} = 0.7\text{ V}$	19	26		mA
Rise Time <sup>1</sup>	$T_{r4B}$	$V_{OL} = 0.4\text{ V}$ , $V_{OH} = 2.0\text{ V}$	0.4	1.35	1.6	ns
Fall Time <sup>1</sup>	$T_{f4B}$	$V_{OH} = 2.0\text{ V}$ , $V_{OL} = 0.4\text{ V}$	0.4	1.01	1.6	ns
Duty Cycle <sup>1</sup>	$D_{t4B}$	$V_T = 1.25\text{ V}$	45	50.3	55	%
Skew	$t_{sk4B}^1$	$V_T = 1.25\text{ V}$		63	250	ps
Jitter, Cycle-to-cycle <sup>1</sup>	$t_{j\text{cyc-cyc}4B}$	$V_T = 1.25\text{ V}$		80	250	ps

<sup>1</sup>Guaranteed by design, not 100% tested in production.

## Electrical Characteristics - 48MHz, REF

$T_A = 0 - 70^\circ\text{C}$ ;  $V_{DD} = 3.3\text{ V} \pm 5\%$ ,  $V_{DDL} = 2.5\text{ V} \pm 5\%$ ;  $C_L = 20\text{ pF}$  (unless otherwise stated)

PARAMETER	SYMBOL	CONDITIONS	MIN	TYP	MAX	UNITS
Output High Voltage	$V_{OH5}$	$I_{OH} = -12\text{ mA}$	2.6	2.9		V
Output Low Voltage	$V_{OL5}$	$I_{OL} = 9\text{ mA}$		0.3	0.4	V
Output High Current	$I_{OH5}$	$V_{OH} = 2.0\text{ V}$		-35	-22	mA
Output Low Current	$I_{OL5}$	$V_{OL} = 0.8\text{ V}$	17	23		mA
Rise Time <sup>1</sup>	$t_{r5}$	$V_{OL} = 0.4\text{ V}$ , $V_{OH} = 2.4\text{ V}$ , 48MHz		1.9	4	ns
Fall Time <sup>1</sup>	$t_{f5}$	$V_{OH} = 2.4\text{ V}$ , $V_{OL} = 0.4\text{ V}$ , 48MHz		2	4	ns
Duty Cycle <sup>1</sup>	$d_{t5}$	$V_T = 1.5\text{ V}$ , 48MHz	45	50.2	55	%
Rise Time <sup>1</sup>	$t_{r5}$	$V_{OL} = 0.4\text{ V}$ , $V_{OH} = 2.4\text{ V}$ , REF		0.7	N/A	ns
Fall Time <sup>1</sup>	$t_{f5}$	$V_{OH} = 2.4\text{ V}$ , $V_{OL} = 0.4\text{ V}$ , REF		0.5	N/A	ns
Duty Cycle <sup>1</sup>	$d_{t5}$	$V_T = 1.5\text{ V}$ , REF	45	52	N/A	%
Jitter, Cycle-to-cycle <sup>1</sup>	$t_{jvc-cyc5}$	$V_T = 1.5\text{ V}$ , 48MHz		239	500	ps
Jitter, Cycle-to-cycle <sup>1</sup>	$t_{jvc-cyc5}$	$V_T = 1.5\text{ V}$ , REF		413	1000	ps

<sup>1</sup>Guaranteed by design, not 100% tested in production.

SYMBOL	In Millimeters COMMON DIMENSIONS		In Inches COMMON DIMENSIONS	
	MIN	MAX	MIN	MAX
A	2.413	2.794	.095	.110
A1	0.203	0.406	.008	.016
b	0.203	0.343	.008	.0135
c	0.127	0.254	.005	.010
D	SEE VARIATIONS		SEE VARIATIONS	
E	10.033	10.668	.395	.420
E1	7.391	7.595	.291	.299
e	0.635 BASIC		0.025 BASIC	
h	0.381	0.635	.015	.025
L	0.508	1.016	.020	.040
N	SEE VARIATIONS		SEE VARIATIONS	
$\alpha$	0°	8°	0°	8°

VARIATIONS

N	D mm.		D (inch)	
	MIN	MAX	MIN	MAX
56	18.288	18.542	.720	.730

JEDEC MO-118  
DOC# 10-0034  
6/100  
REV B

300 mil SSOP

## Ordering Information

932S200yFT

Example:

XXXX y F - PPP T

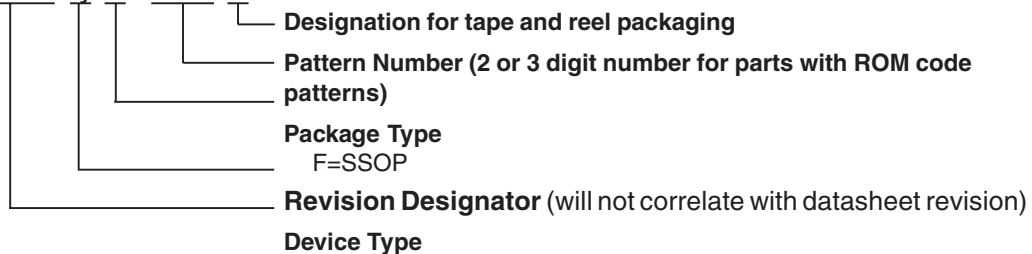

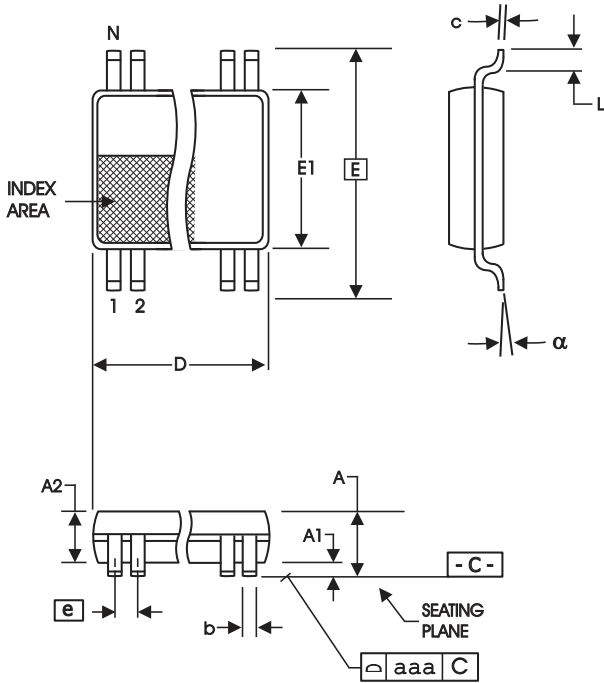

**6.10 mm. Body, 0.50 mm. pitch TSSOP**  
**(240 mil) (0.020 mil)**

SYMBOL	In Millimeters		In Inches	
	COMMON DIMENSIONS		COMMON DIMENSIONS	
	MIN	MAX	MIN	MAX
A	--	1.20	--	.047
A1	0.05	0.15	.002	.006
A2	0.80	1.05	.032	.041
b	0.17	0.27	.007	.011
c	0.09	0.20	.0035	.008
D	SEE VARIATIONS		SEE VARIATIONS	
E	8.10 BASIC		0.319 BASIC	
E1	6.00	6.20	.236	.244
e	0.50 BASIC		0.020 BASIC	
L	0.45	0.75	.018	.030
N	SEE VARIATIONS		SEE VARIATIONS	
α	0°	8°	0°	8°
aaa	--	0.10	--	.004

**VARIATIONS**

N	D mm.		D (inch)	
	MIN	MAX	MIN	MAX
56	13.90	14.10	.547	.555

Reference Doc.: JEDEC Publication 95, MO-153  
 10-0039

**Ordering Information**

**932S200yGT**

Example:

**XXXX y G - PPP T**

- XXXX — Revision Designator (will not correlate with datasheet revision)
- y — Designation for tape and reel packaging
- G — Package Type (G=TSSOP)
- PPP — Pattern Number (2 or 3 digit number for parts with ROM code patterns)
- T — Device Type

**Revision History**

<b>Rev.</b>	<b>Issue Date</b>	<b>Description</b>	<b>Page #</b>
D	12/15/2008	Removed ICS prefix from ordering information	11-12

## IMPORTANT NOTICE AND DISCLAIMER

RENESAS ELECTRONICS CORPORATION AND ITS SUBSIDIARIES (“RENESAS”) PROVIDES TECHNICAL SPECIFICATIONS AND RELIABILITY DATA (INCLUDING DATASHEETS), DESIGN RESOURCES (INCLUDING REFERENCE DESIGNS), APPLICATION OR OTHER DESIGN ADVICE, WEB TOOLS, SAFETY INFORMATION, AND OTHER RESOURCES “AS IS” AND WITH ALL FAULTS, AND DISCLAIMS ALL WARRANTIES, EXPRESS OR IMPLIED, INCLUDING, WITHOUT LIMITATION, ANY IMPLIED WARRANTIES OF MERCHANTABILITY, FITNESS FOR A PARTICULAR PURPOSE, OR NON-INFRINGEMENT OF THIRD PARTY INTELLECTUAL PROPERTY RIGHTS.

These resources are intended for developers skilled in the art designing with Renesas products. You are solely responsible for (1) selecting the appropriate products for your application, (2) designing, validating, and testing your application, and (3) ensuring your application meets applicable standards, and any other safety, security, or other requirements. These resources are subject to change without notice. Renesas grants you permission to use these resources only for development of an application that uses Renesas products. Other reproduction or use of these resources is strictly prohibited. No license is granted to any other Renesas intellectual property or to any third party intellectual property. Renesas disclaims responsibility for, and you will fully indemnify Renesas and its representatives against, any claims, damages, costs, losses, or liabilities arising out of your use of these resources. Renesas' products are provided only subject to Renesas' Terms and Conditions of Sale or other applicable terms agreed to in writing. No use of any Renesas resources expands or otherwise alters any applicable warranties or warranty disclaimers for these products.

(Disclaimer Rev.1.0 Mar 2020)

### Corporate Headquarters

TOYOSU FORESIA, 3-2-24 Toyosu,  
Koto-ku, Tokyo 135-0061, Japan  
[www.renesas.com](http://www.renesas.com)

### Contact Information

For further information on a product, technology, the most up-to-date version of a document, or your nearest sales office, please visit:  
[www.renesas.com/contact/](http://www.renesas.com/contact/)

### Trademarks

Renesas and the Renesas logo are trademarks of Renesas Electronics Corporation. All trademarks and registered trademarks are the property of their respective owners.