

TIG067SS



ON Semiconductor®

www.onsemi.com

IGBT

400V, 150A, VCE(sat);3.8V Single N-Channel

Features

- Low-saturation Voltage
- Enhancement Type
- High Speed Switching
- 4.0V Drive
- Built-in Gate-to-Emitter Protection Diode
- Pb-Free, Halogen Free and RoHS Compliance

Applications

- Light-controlling Flash

Specifications

Absolute Maximum Ratings at Ta=25°C

Parameter	Symbol	Conditions	Ratings	Unit
Collector-to-Emitter Voltage (DC)	V _{CES}		400	V
Collector-to-Emitter Voltage (Pulse)	V _{CESP}	PW≤1ms	450	V
Gate-to-Emitter Voltage (DC)	V _{GES}		±6	V
Gate-to-Emitter Voltage (Pulse)	V _{GESP}	PW≤1ms	±8	V
Collector Current (Pulse)	I _{CP}	C _M =600μF	150	A
Maximum Collector-to-Emitter dv / dt	dv / dt	V _{CE} ≤320V, starting T _{ch} =25°C	1500	V / μs
Allowable Power Dissipation	P _D	When mounted on FR4 substrate (11,680mm ² ×1.6mm)	1.2	W
Channel Temperature	T _{ch}		150	°C
Storage Temperature	T _{stg}		-40 to +150	°C

Stresses exceeding Maximum Ratings may damage the device. Maximum Ratings are stress ratings only. Functional operation above the Recommended Operating Conditions is not implied. Extended exposure to stresses above the Recommended Operating Conditions may affect device reliability.

Package Dimensions

unit : mm (typ)

7072-002

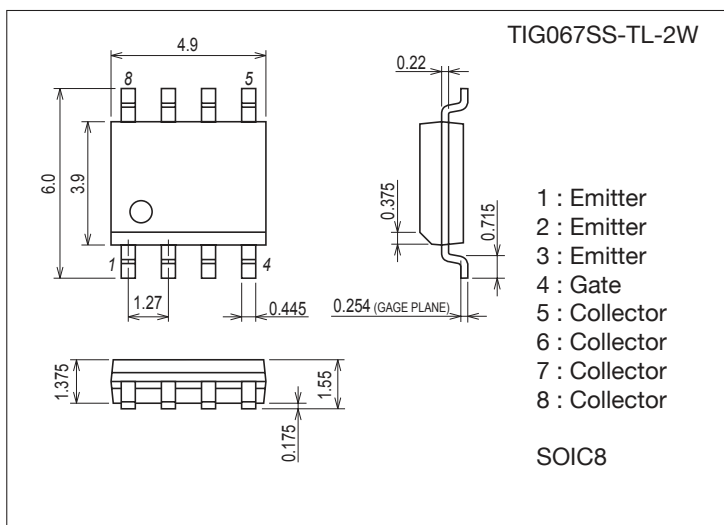

Product & Package Information

- Package : SOIC8
- JEITA, JEDEC : SC-87, SOT-96
- Minimum Packing Quantity : 2500 pcs./reel

Packing Type: TL

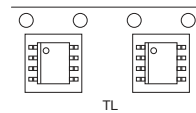

Marking

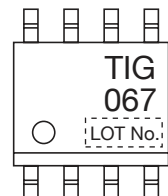

Electrical Connection

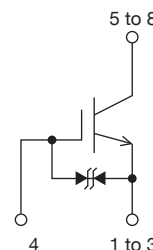

ORDERING INFORMATION

See detailed ordering and shipping information on page 2 of this data sheet.

TIG067SS

Electrical Characteristics at Ta=25°C

Parameter	Symbol	Conditions	Ratings			Unit
			min	typ	max	
Collector-to-Emitter Breakdown Voltage	$V_{(BR)CES}$	$I_C=2mA, V_{GE}=0V$	400			V
Collector-to-Emitter Cutoff Current	I_{CES}	$V_{CE}=320V, V_{GE}=0V$			10	μA
Gate-to-Emitter Leakage Current	I_{GES}	$V_{GE}=\pm 6V, V_{CE}=0V$			± 10	μA
Gate-to-Emitter Threshold Voltage	$V_{GE(off)}$	$V_{CE}=10V, I_C=1mA$	0.4		1.0	V
Collector-to-Emitter Saturation Voltage	$V_{CE(sat)}$	$I_C=150A, V_{GE}=4V$		3.8	5	V
Input Capacitance	C_{ies}			5100		pF
Output Capacitance	C_{oes}	$V_{CE}=10V, f=1MHz$		59		pF
Reverse Transfer Capacitance	C_{res}			43		pF
Fall Time	t_f	$I_C=150A, V_{CC}=320V, \text{Resistor load } V_{GE}=4V, R_G=36\Omega$		270		ns

Product parametric performance is indicated in the Electrical Characteristics for the listed test conditions, unless otherwise noted. Product performance may not be indicated by the Electrical Characteristics if operated under different conditions.

Fig1 Large Current R Load Switching Circuit

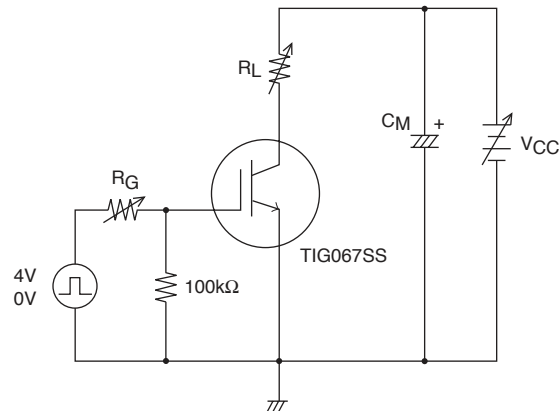

Note1. Gate Series Resistance $R_G \geq 36\Omega$ is recommended for protection purpose at the time of turn OFF. However, if $dv/dt \leq 1500/\mu s$ is satisfied at customer's actual set evaluation, $R_G < 36\Omega$ can also be used.

Note2. The collector voltage gradient dv/dt must be smaller than $1500V/\mu s$ to protect the device when it is turned off.

ORDERING INFORMATION

Device	Package	Shipping	memo
TIG067SS-TL-2W	SOIC8	2,500pcs./reel	Pb-Free and Halogen Free

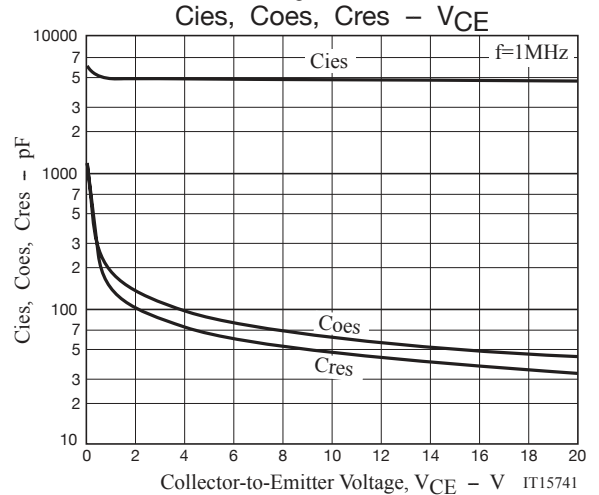
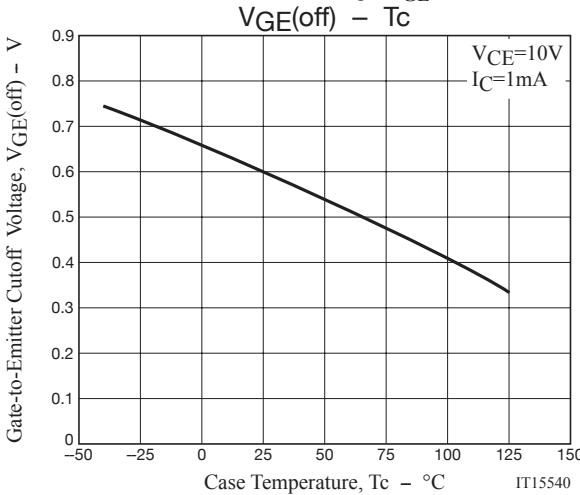
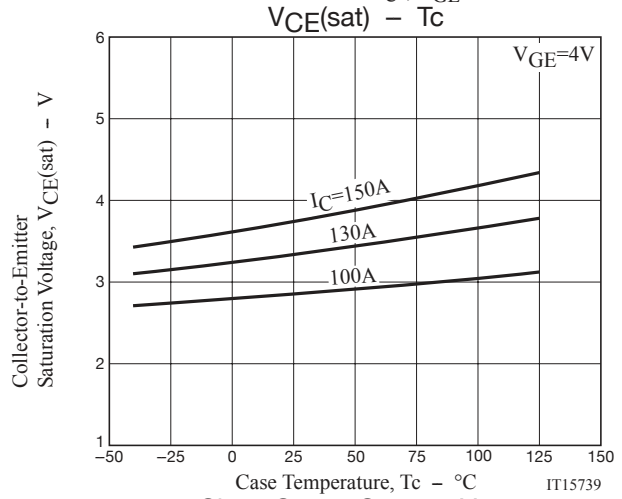
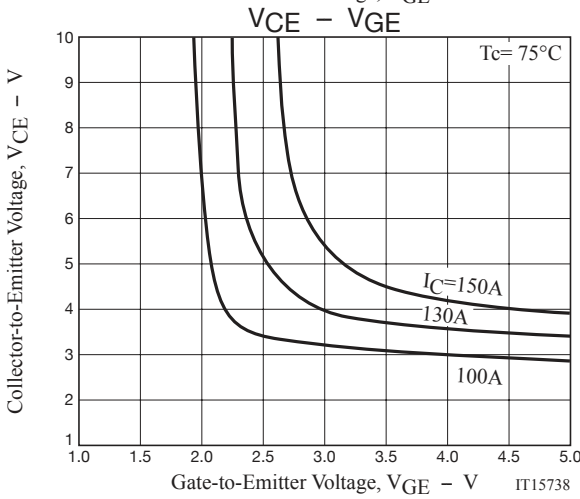
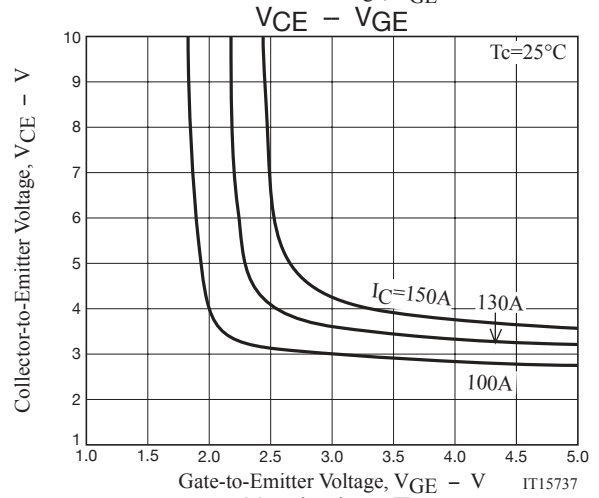
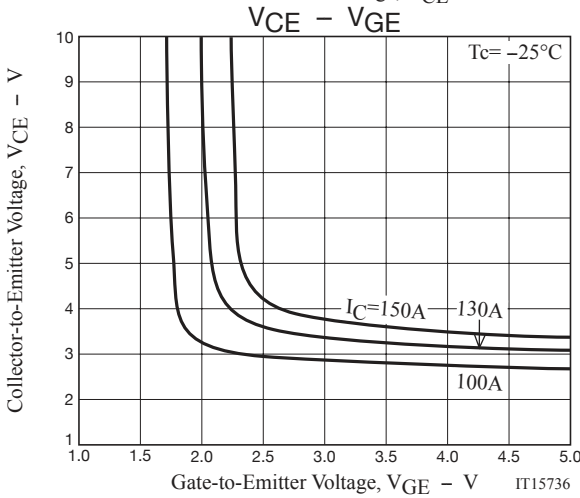
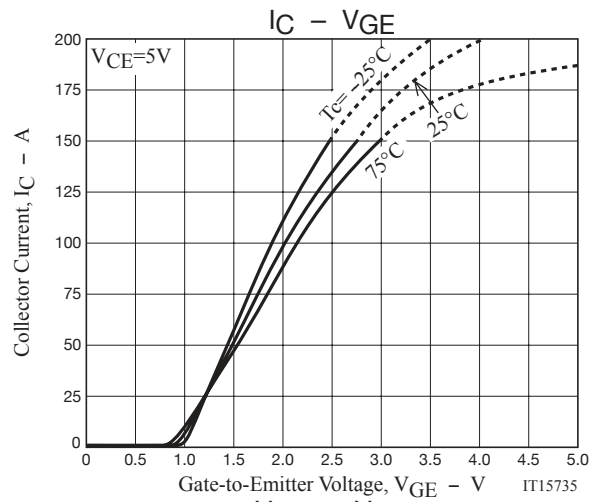
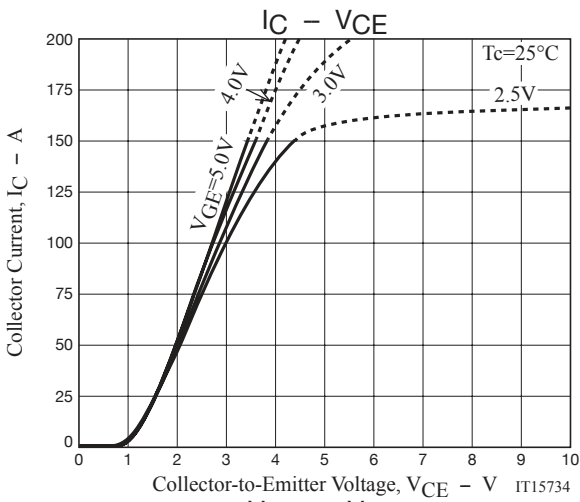

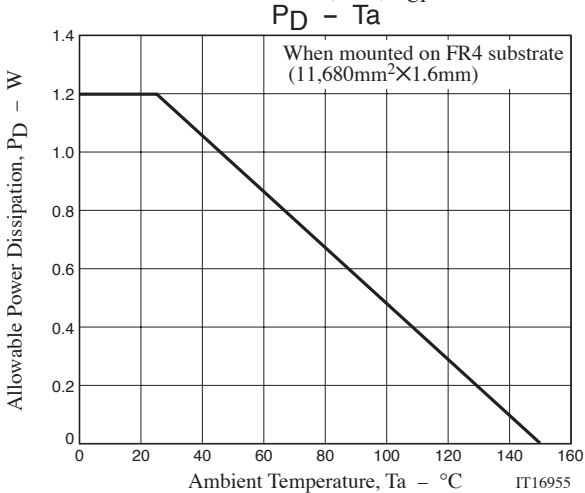
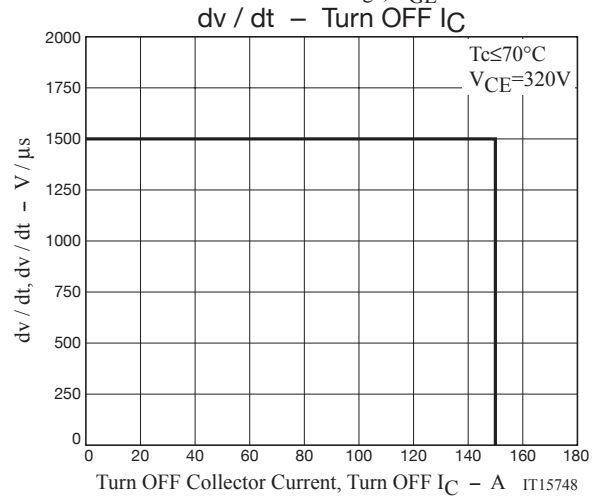
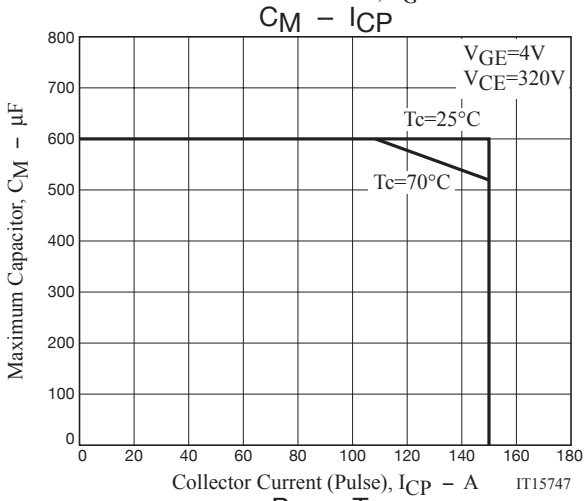
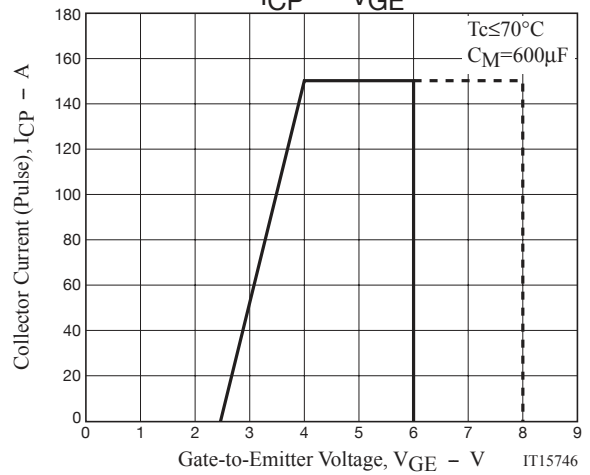
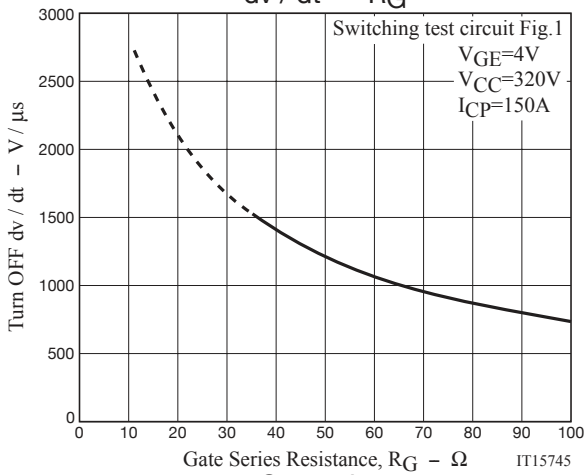
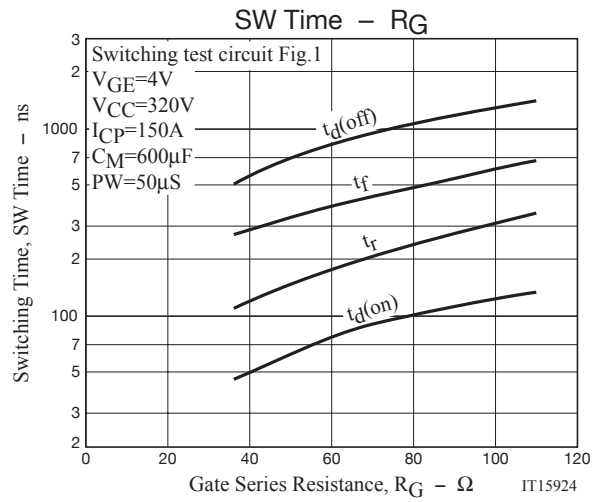
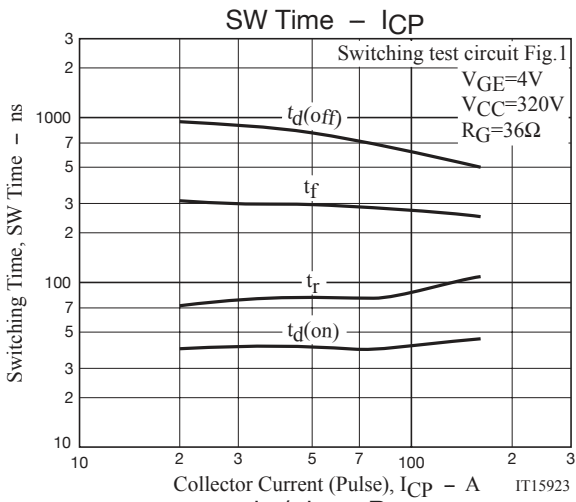

Definition of dv/dt

dv/dt is defined as the maximum slope of the below V_{CE} curve during turn-off period.
 $dv/dt = \Delta V_{CE} / \Delta t = \Delta V_{CE} / 100ns$

Overall waveform

Enlarged picture of turn-off period

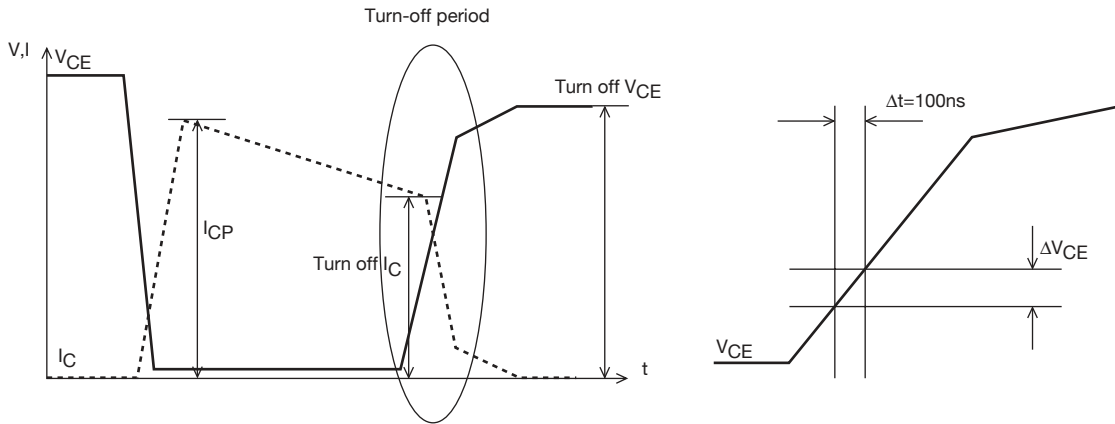

Definition of Switching Time

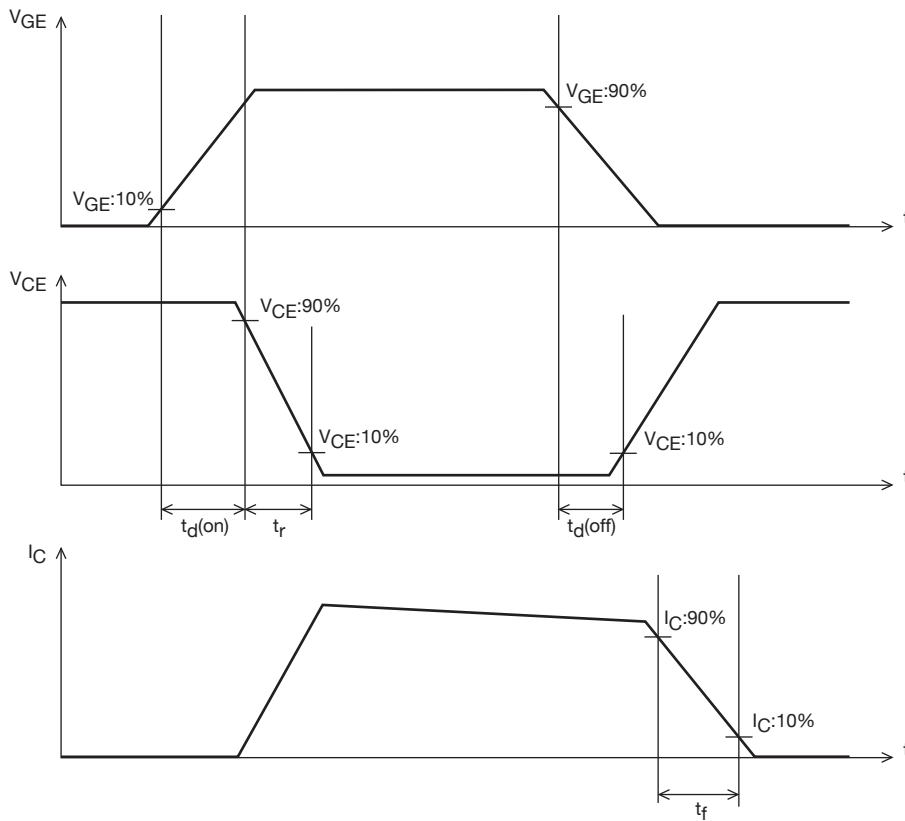

TIG067SS

Outline Drawing TIG067SS-TL-2W

Land Pattern Example

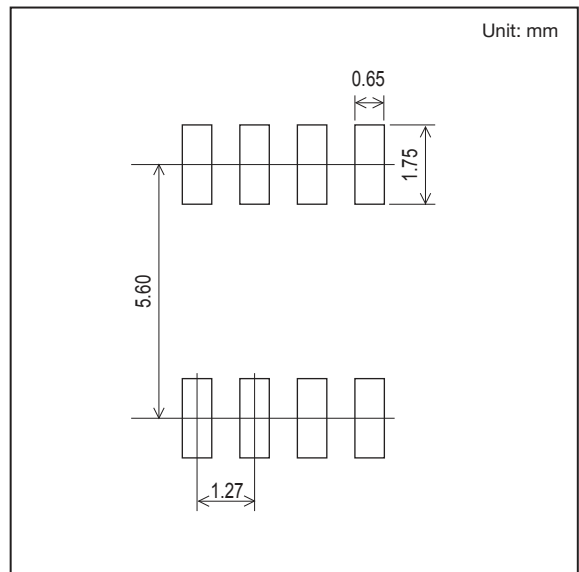
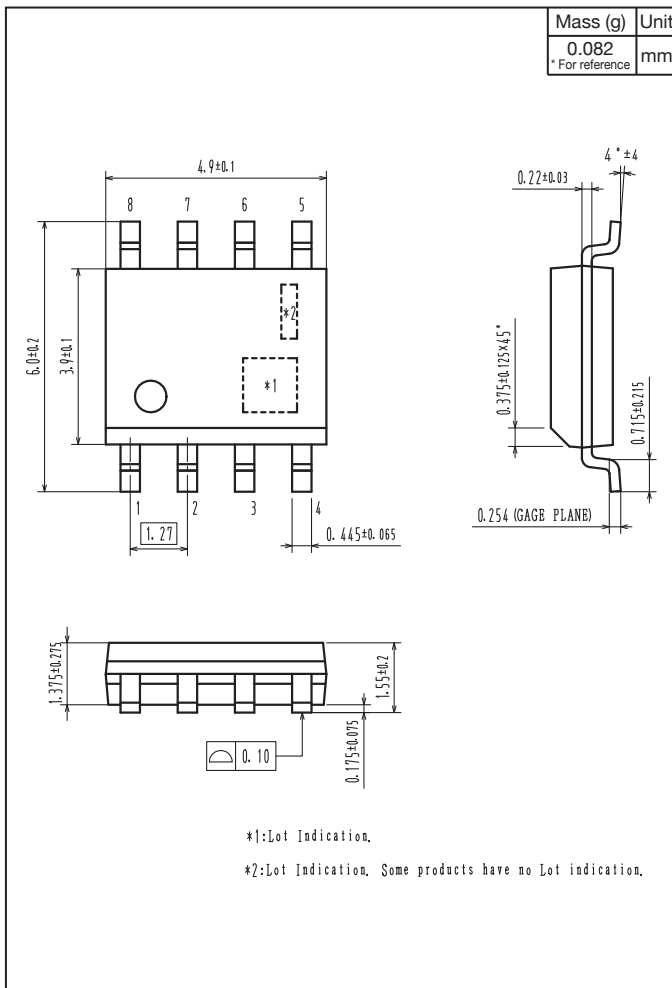

ON Semiconductor and the ON logo are registered trademarks of Semiconductor Components Industries, LLC (SCILLC) or its subsidiaries in the United States and/or other countries. SCILLC owns the rights to a number of patents, trademarks, copyrights, trade secrets, and other intellectual property. A listing of SCILLC's product/patent coverage may be accessed at www.onsemi.com/site/pdf/Patent-Marking.pdf. SCILLC reserves the right to make changes without further notice to any products herein. SCILLC makes no warranty, representation or guarantee regarding the suitability of its products for any particular purpose, nor does SCILLC assume any liability arising out of the application or use of any product or circuit, and specifically disclaims any and all liability, including without limitation special, consequential or incidental damages. "Typical" parameters which may be provided in SCILLC data sheets and/or specifications can and do vary in different applications and actual performance may vary over time. All operating parameters, including "Typicals" must be validated for each customer application by customer's technical experts. SCILLC does not convey any license under its patent rights nor the rights of others. SCILLC products are not designed, intended, or authorized for use as components in systems intended for surgical implant into the body, or other applications intended to support or sustain life, or for any other application in which the failure of the SCILLC product could create a situation where personal injury or death may occur. Should Buyer purchase or use SCILLC products for any such unintended or unauthorized application, Buyer shall indemnify and hold SCILLC and its officers, employees, subsidiaries, affiliates, and distributors harmless against all claims, costs, damages, and expenses, and reasonable attorney fees arising out of, directly or indirectly, any claim of personal injury or death associated with such unintended or unauthorized use, even if such claim alleges that SCILLC was negligent regarding the design or manufacture of the part. SCILLC is an Equal Opportunity/Affirmative Action Employer. This literature is subject to all applicable copyright laws and is not for resale in any manner.