

SMD 1206, Pt Temperature Sensor according to DIN EN 60751

Temperature range -50 °C to +130 °C (150 °C*)

- Pt RTD in standard SMD format
- High accuracy and interchangeability of a platinum sensor
- Automated mounting via standard pick-and-place tools
- Blister reel packaging
- Available in large volumes

SMD 1206 Pt RTD elements are designed for automated assembly on printed circuit boards. The precision, accuracy and interchangeability of a Pt RTD in an SMD package provides an ideal solution for board-mounted temperature sensing, board protection, and temperature compensation. Application areas include HVAC, automobiles, e-mobility, and medical and industrial equipment.

In principle, the products can also be used in automotive applications, in this case YAGEO Nexensos will check upon the request of the customer, whether additional requirements can be met (e.g. IMDS, PPAP).

Nominal Resistance R ₀ [Ω]	Tolerance Class	Order Number	Packaging
Pt100	F 0.3 (B) F 0.6 (2B)	32207590 32207589	Blister reel Blister reel
Pt1000	F 0.3 (B) F 0.6 (2B)	32207595 32207594	Blister reel Blister reel

Temperature Range of Tolerance Class

Validity of Class F 0.3 (B) -50 °C to +130 °C

Validity of Class F 0.6 (2B) -50 °C to +130 °C

*(With the use of expansion-matched circuit board materials temperatures up to +150 °C are possible)

Temperature Coefficient

TCR = 3850 ppm/K

Response Time

Water (v = 0.4 m/s): t_{0.5} = 0.15 s

t_{0.9} = 0.3 s

Air (v = 2 m/s): t_{0.5} = 3.5 s

t_{0.9} = 10 s

Measuring Current

Pt100 Ω: 0.3 to 1 mA

Pt1000 Ω: 0.1 to 0.3 mA

(self-heating has to be considered)

Long-Term Stability

The drift of the resistance value at 0 °C after a storage for 1000 hours in air at the declared upper temperature limit is not more than the tolerance value of the declared tolerance class according DIN EN 60751.

Typical drift of R(0 °C) is 0.06 % after 1000 hours at +150 °C.

Self-Heating

0.4 K/mW at 0 °C

YAGEO Nexensos GmbH, Germany
Web: www.yageo-nexensos.com
Contact: nexensos.america@yageo.com

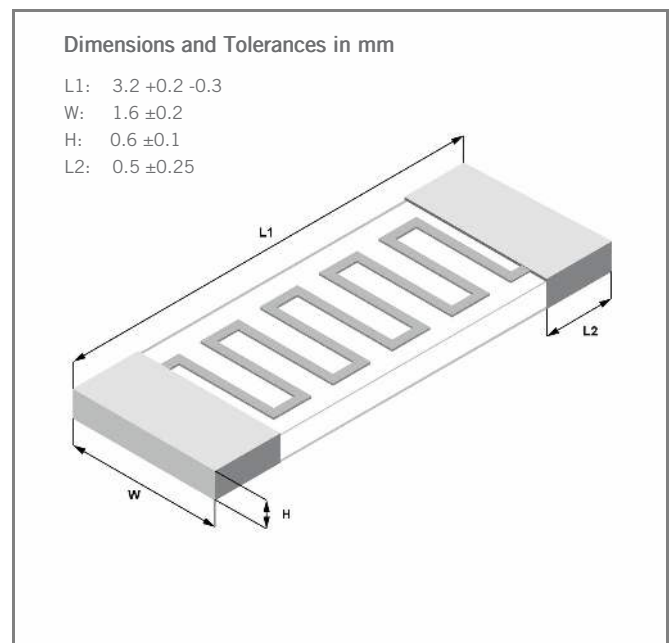

Image for illustration purposes only
Color, shape and forming of metallization may vary

SMD 1206, Pt Temperature Sensor according to DIN EN 60751

Temperature range -50 °C to +130 °C (150 °C*)

Types

Pt 1000 SMD 0603
Pt 1000 SMD 0805
Pt 1000 SMD 1206

Mounting

Layout of the circuit board: Benchmark II 150Qm (Material FR4 35Qm Cu, size 190.5 x 127 x 1.5mm)
Circuit board surfaces: chem. Ag, Cu OSP, NiAu, chem. Sn
Soldering paste: F640 SA30C5-89 M30 (Material SnAgCu 96.5/3.0/0.5)

Soldering Conditions

Limit profiles: High and Low
Atmosphere: Nitrogen and air

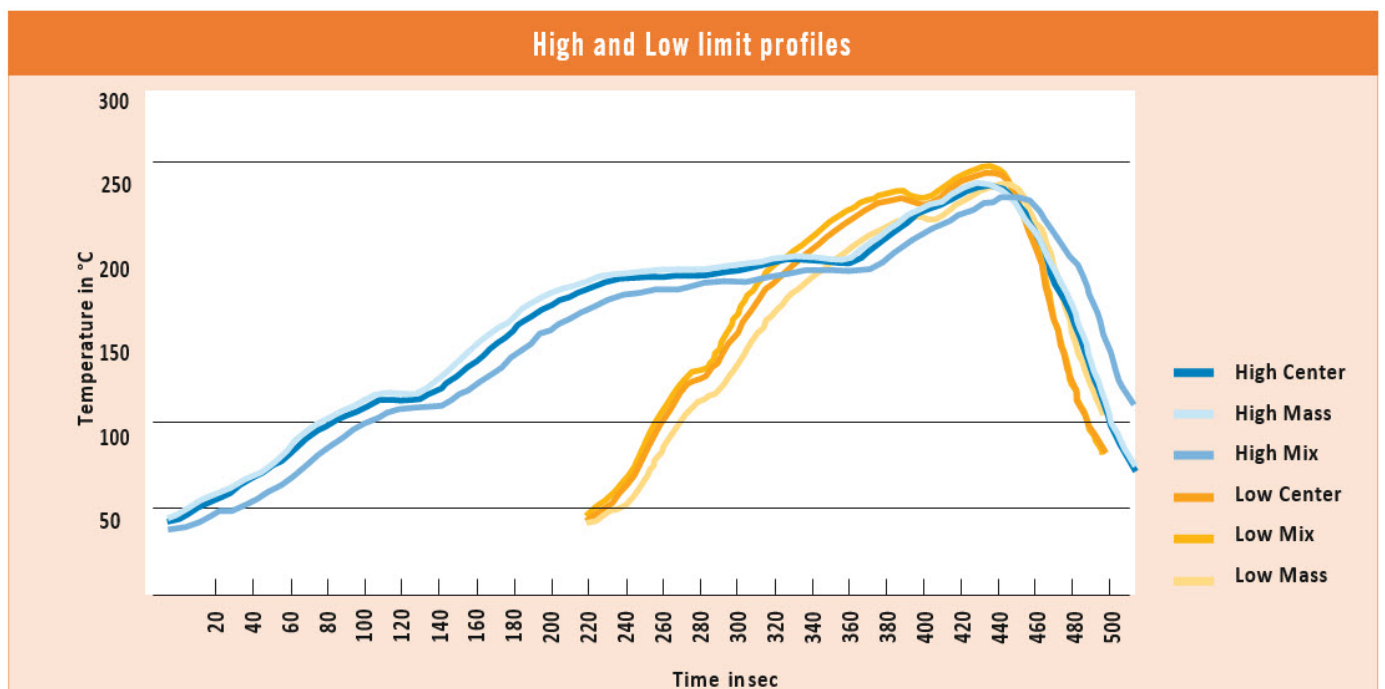

		Peak (max. temperature)		Time over 217 °C in sec.	
		High [Total throughput time 520 sec]	Low [Total throughput time 280 sec]	High [Total throughput time 520 sec]	Low [Total throughput time 280 sec]
Sensor position on circuit board	Center	+237 °C	+245 °C	60	92
	Mass	+231 °C	+238 °C	49	68
	Mix	+238 °C	+248 °C	65	103

Result

All tested samples showed a sufficient wetting under the described profiles High and Low, based on a visual soldering point inspection. All given data should not be constructed as guaranteeing specific properties of the product or its suitability for a specific particular application. The data are an extract from a test report with status from July 2010.

SMD 1206, Pt Temperature Sensor according to DIN EN 60751

Temperature range -50 °C to +130 °C (150 °C*)

Soldering Connection

End termination galvanic tin plated with Ni barrier layer

Connection Technology

Face up mounting; reflow soldering or wave soldering, e.g double wave ≤ 8 s/235 °C

Packaging

Blister reel

"Face-up" 4000 pcs/ reel

Alternative packaging forms on request

Storage Life

At least 9 months (after manufacture), when stored under the recommended conditions. Longer shelf life may be possible, depending upon actual storage conditions, after requalification by customer.

Nitrogen atmosphere recommended.

Note

Other tolerances and values of resistance are available on request

California Proposition 65



WARNING

WARNING: This product can expose you to chemicals including nickel, which is known to the State of California to cause cancer.

For more information go to www.p65warnings.ca.gov



The information provided in this data sheet describes certain technical characteristics of the product, but shall not be qualified or construed as quality guarantee (Beschaffenheitsgarantie) in the meaning of sections 443 and 444 German Civil Code. The information provided in this data sheet regarding measurement values (including, but not limited to, response time, long-term stability, vibration and shock resistance, insulation resistance and self-heating) are average values that have been obtained under laboratory conditions in tests of large numbers of the product. Product results or measurements achieved by customer or any other person in any production, test, or other environment may vary depending on the specific conditions of use.

The customer is solely responsible to determine whether the product is suited for the customer's intended use; in this respect YAGEO Nexensos cannot assume any liability. The sale of any products by YAGEO Nexensos is exclusively subject to the General Terms of Sale and Delivery of YAGEO Nexensos in their current version at the time of purchase, which is available under www.yageo-nexensos.com/tc or may be furnished upon request. This data sheet is subject to changes without prior notice.

YAGEO Nexensos GmbH, Reinhard-Heraeus-Ring 23, 63801 Kleinostheim, Germany