

## **LMX2492EVM Evaluation Module**

The LMX2492EVM is design to evaluate the performance of LMX2492. This board consists of a LMX2492 device, a LP5900-3.3V LDO, a 9.4 - 10.8 GHz VCO and a 100 MHz crystal oscillator.

The LMX2492 is a low noise 14 GHz wideband delta-sigma fractional N PLL with ramp and chirp generation. It consists of a phase frequency detector, programmable charge pump, and high frequency input for the external VCO. The LMX2492 supports a broad and flexible class of ramping capabilities, including FSK and configurable piecewise linear FM modulation profiles of up to 8 segments.

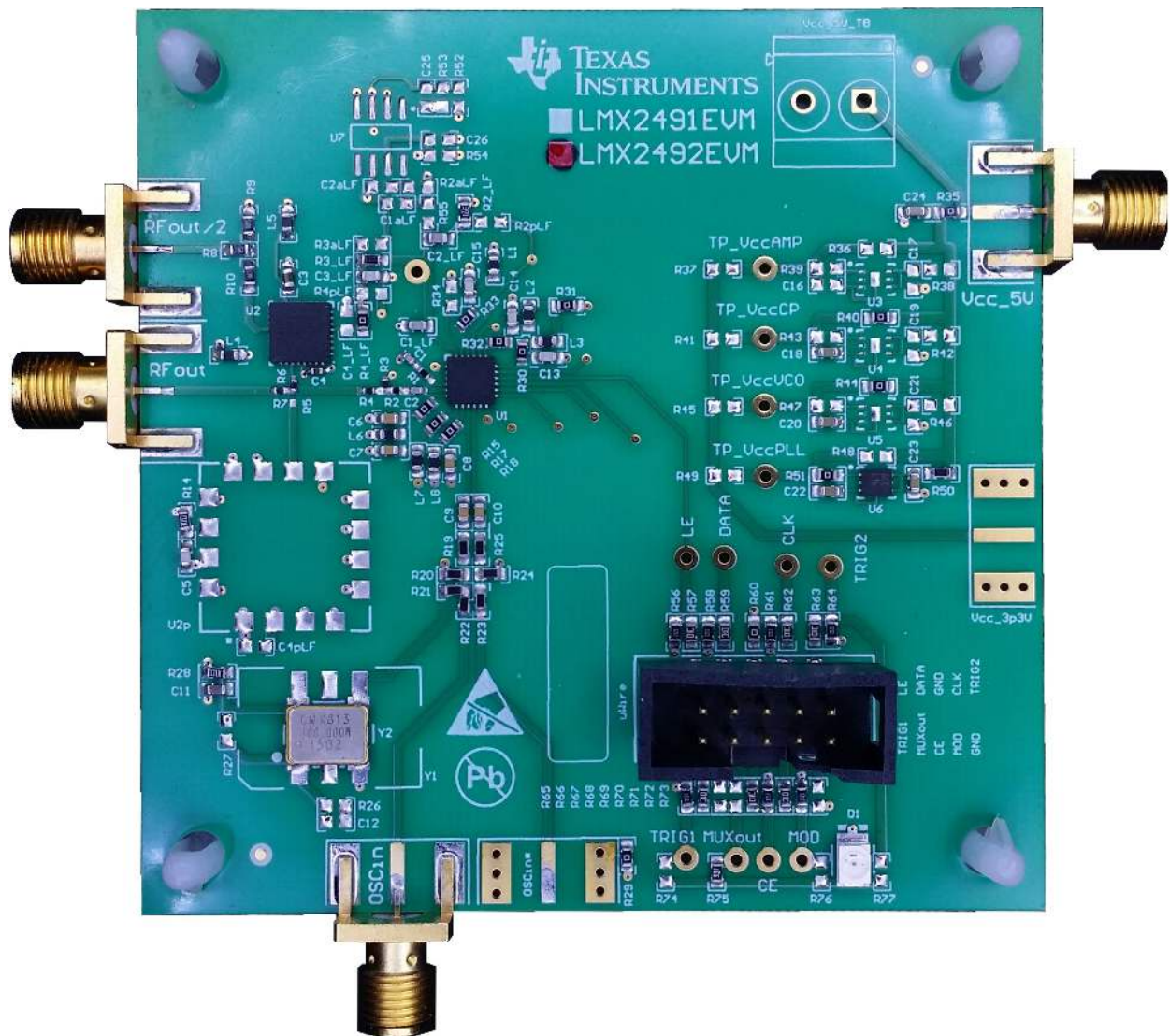

### **Contents**

1	LMX2492EVM Evaluation Module .....	3
2	Setup .....	4

3	Typical Measurement .....	6
4	Schematic .....	12
5	PCB Layout and Layer Stack-up .....	14
6	Bill of Materials .....	17
7	Troubleshooting Guide .....	18
Appendix A	USB2ANY Firmware Upgrade .....	19
Appendix B	Using Different Reference Clock .....	22

### List of Figures

1	EVM Connection Diagram .....	4
2	Select Device in TICS Pro .....	5
3	Default Mode .....	5
4	IO Port .....	5
5	Loop Filter .....	6
6	Default Output .....	7
7	TICS Pro FSK Configuration .....	7
8	FSK Example .....	8
9	Continuous Sawtooth Ramp Configuration .....	8
10	Continuous Sawtooth Ramp Example .....	9
11	Continuous Trapezoid Ramp Configuration .....	9
12	Flag Out Pins Configuration .....	10
13	Flags Out Timing .....	10
14	Continuous Trapezoid Ramp Example .....	10
15	Readback Setting .....	11
16	Register Readback .....	11
17	LMX2492EVM Schematic (Page 1) .....	12
18	LMX2492EVM Schematic (Page 2) .....	13
19	PCB Layer Stack-up .....	14
20	Top Layer .....	14
21	GND Layer .....	15
22	Power Layer .....	15
23	Bottom Layer .....	16
24	Troubleshooting Guide .....	18
25	Firmware Requirement .....	19
26	Firmware Loader .....	19
27	BSL Button .....	20
28	Update Firmware .....	20
29	Firmware Update Completed .....	21
30	USB Communications .....	21
31	Reference Clock Input Configuration .....	22

### List of Tables

1	Loop Filter Configuration .....	6
2	Bill of Materials .....	17

### Trademarks

All trademarks are the property of their respective owners.

## 1 LMX2492EVM Evaluation Module

### 1.1 Evaluation Module Contents

In the box, there are:

- One LMX2492EVM board (SV601040-002).
- One USB2ANY module (HPA665-001).
- One USB cable.
- One 10-pin ribbon cable.

### 1.2 Evaluation Setup Requirement

The evaluation will require the following hardware and software:

- A DC power supply
- A spectrum analyzer or a signal analyzer
- A PC running Windows 7 or more recent version
- An oscilloscope (optional)
- A high quality signal generator (optional)
- A function waveform generator (optional)
- Texas Instruments Clocks and Synthesizers TICS Pro software
- Texas Instruments PLLatinum Simulator Tool (optional)

### 1.3 Resources

Related evaluation and development resources are as follows:

- [LMX2492 datasheet](#)
- [LMX2491 datasheet](#)
- [TICS Pro software](#)
- [PLLatinum Simulator Tool](#) (PLL Sim)

## 2 Setup

### 2.1 Connection Diagram

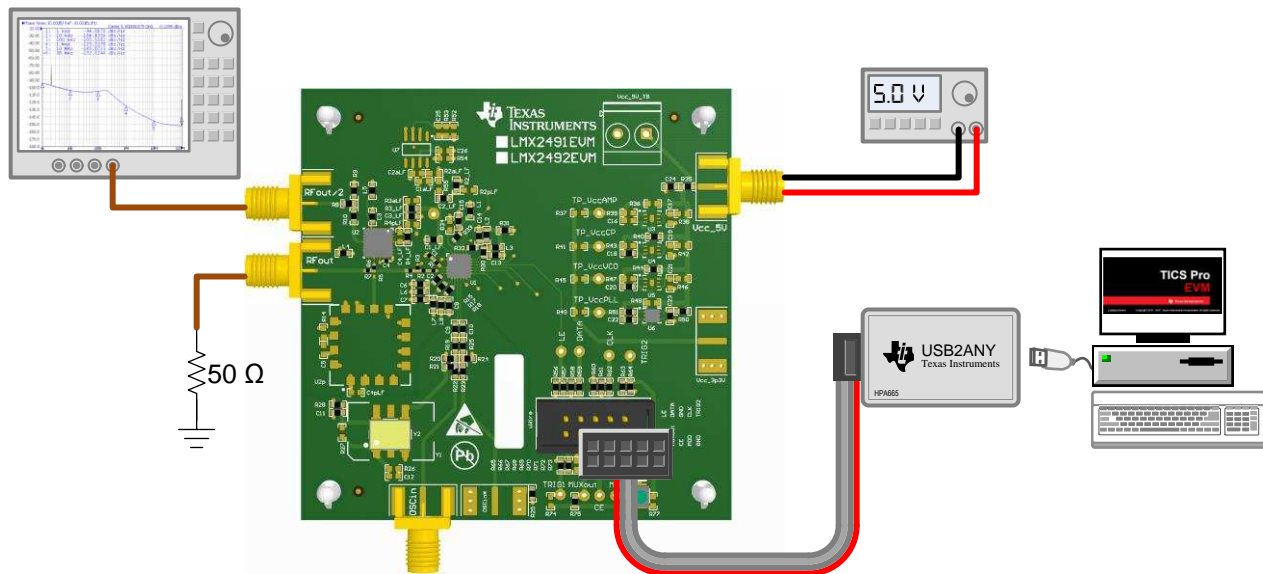

**Figure 1. EVM Connection Diagram**

### 2.2 Power Supply

Apply 5-V to Vcc\_5V SMA connector. The on-board VCO and the optional op-amp require 5-V supply while the on-board XO and LMX2492 need 3.3-V supply. The on-board LDO regulates 5-V down to 3.3-V. Never apply more than 6-V to Vcc\_5V SMA connector or otherwise the LDO will be damaged. The total current consumption of the board is about 240 mA.

### 2.3 Reference Clock

By default, the board is operated with the on-board 100-MHz CMOS XO. If required, the board can be modified to operate with an external clock source. In this case, apply a single-ended clock to the OSCin SMA connector or apply a differential clock to both OSCin and OSCin\* SMA connectors. See [Appendix B](#) for details.

### 2.4 RF Output

Connect RFOut/2 SMA connector to a spectrum analyzer or a signal analyzer. By default, the output signal frequency is 4.8 GHz and the amplitude is about  $-3$  dBm. Because the frequency accuracy of the on-board XO is 25 ppm, RF output frequency may also be off by 25 ppm. The phase noise of the XO is not bad but not excellent, as a result, RF output phase noise may not look very good.

### 2.5 Programming

Connect the uWire header to a PC using the USB2ANY module. The firmware of the USB2ANY may not be up-to-date. In this case, follow the procedures outlined in [Appendix A](#) to get it updated.

### 2.6 Evaluation Software

Download and install TICS Pro to a PC. Run the software and follow the following steps to get started.

1. Go to "Select Device" → "PLL" → LMX2492

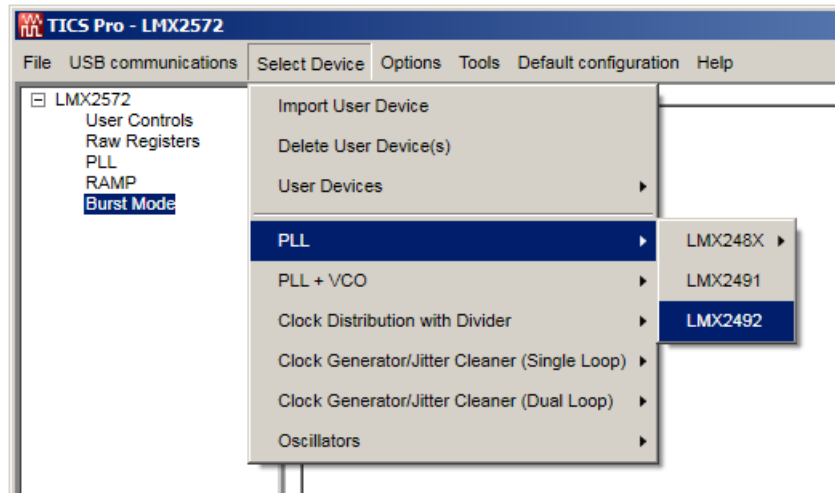

Figure 2. Select Device in TICS Pro

2. Go to "Default configuration" → "Default Mode xxxx-xx-xx"

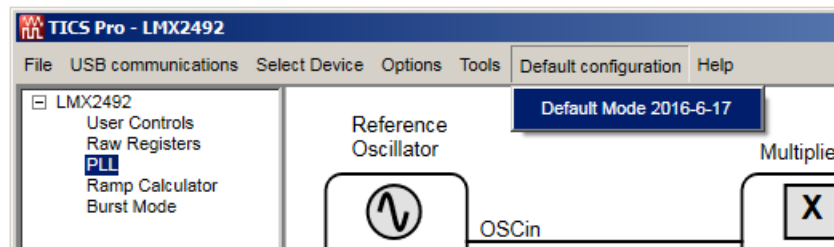

Figure 3. Default Mode

## 2.7 EVM Strap Options

The MUXout pin is not connected to the uWire header but is used as the lock detect indicator. Other IO pins, such as TRIG1, TRIG2 and MOD are connected to the uWire header. They could be used as the input trigger sources or output flag indicators during frequency ramping.

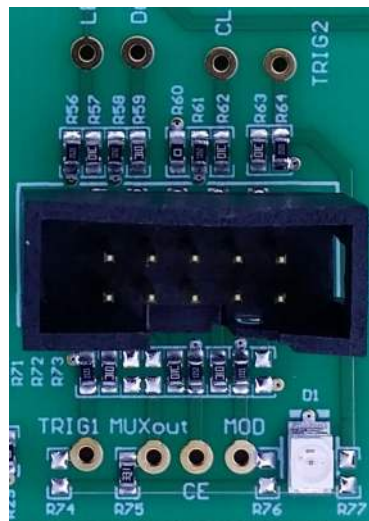

Figure 4. IO Port

### 3 Typical Measurement

#### 3.1 Default Configuration

##### 3.1.1 Loop Filter

The parameters for the loop filter are:

**Table 1. Loop Filter Configuration**

PARAMETER	VALUE
VCO frequency	9.4 - 10.8 GHz
VCO gain	240 MHz/V
Effective charge pump gain	3.1 mA
Phase detector frequency	100 MHz
Loop bandwidth	435 kHz
Phase margin	60.8 degrees
C1_LF	68 pF
C2_LF	3.9 nF
C3_LF	150 pF
C4_LF	Open
R2_LF	390 $\Omega$
R3_LF	150 $\Omega$
R4_LF	0 $\Omega$

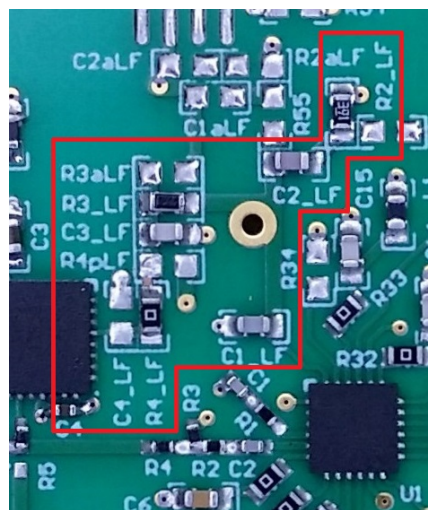

**Figure 5. Loop Filter**

##### 3.1.2 Typical Output

1. Follow [Section 2](#) to setup the evaluation.
  2. Go to "USB communications" → "Write All Registers" to write all the registers to LMX2492.
- Default output is 4.8 GHz at RFout/2 SMA connector.

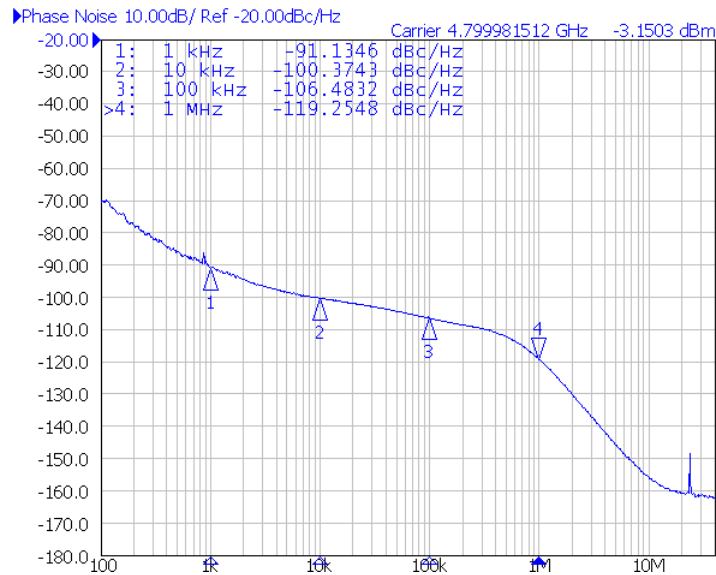

Figure 6. Default Output

### 3.2 Additional Tests

#### 3.2.1 Frequency Shift Keying (FSK) Example

FSK operation requires an external input trigger signal at either MOD, TRIG1 or TRIG2 pin. In this example, MOD pin is selected as the Trigger A source. A 20 kHz square-wave clock will be applied to MOD pin to toggle the RF output to switch between 9600 MHz and 9604 MHz. That is, FSK deviation is 4 MHz.

The screenshot shows the TICS Pro configuration interface with the following settings highlighted:

- General Tab:**
  - TRIG2\_PIN:** MOD\_PIN (highlighted with a red box)
  - TRIG2\_MUX:** Input
- General Ramp Controls Tab:**
  - RAMP\_EN:** Checked (highlighted with a red box)
  - RAMP\_TRIGA:** MOD Rising Edge (highlighted with a red box)
  - FSK\_DEV\_TRIG:** Trigger A (highlighted with a red box)
  - FSK\_DEV:** 671089

Figure 7. TICS Pro FSK Configuration

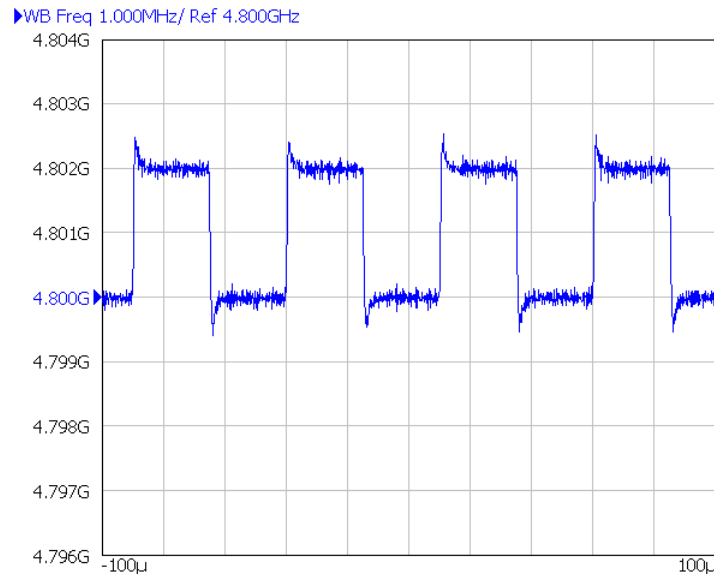

Figure 8. FSK Example

### 3.2.2 Continuous Sawtooth Ramp Example

This example shows how to generate a continuous sawtooth ramp. Only one ramp segment is necessary as it will loop back to itself.

#### Limits and Comparators

<b>VCO Output Limit</b> High 12000 MHz Low 9000 MHz		Valid In Ramp 0 1 2 3 4 5 6 7 <input type="checkbox"/> <input type="checkbox"/> <input type="checkbox"/> <input type="checkbox"/> <input type="checkbox"/> <input type="checkbox"/> <input type="checkbox"/> <input type="checkbox"/>	Register Programming Sign Decimal Value 2's Complement High 0 402653184 402653184 Low 1 100683296 8489271296		
CMP0 9800 MHz CMP1 9400 MHz			Sign Decimal Value 2's Complement CMP0 0 33554432 33554432 CMP1 1 33554432 8556380160		

*This range must be greater than the ramp range*

*Don't care because they are not enabled*

#### Ramps

Ramp Enable

Ramp Number	Actual Start Frequency (MHz)	Desired End Frequency (MHz)	Duration (us)	Dly	Next Ramp	Start next ramp after	RST	FL	Flags	Actual End Frequency (MHz)	Length	Increment (dec)
0	9600	9700	100	<input type="checkbox"/>	0	TOC Timeout	<input checked="" type="checkbox"/>	<input type="checkbox"/>	Disabled	9700.01659392	10000	1678
1	-1	10500	100	<input type="checkbox"/>	0	TOC Timeout	<input type="checkbox"/>	<input type="checkbox"/>	Disabled	-1	10000	10000
2	-1	10500	100	<input type="checkbox"/>	0	TOC Timeout	<input type="checkbox"/>	<input type="checkbox"/>	Disabled	-1	10000	10000
3	-1	10500	100	<input type="checkbox"/>	0	TOC Timeout	<input type="checkbox"/>	<input type="checkbox"/>	Disabled	-1	10000	10000
4	-1	10500	100	<input type="checkbox"/>	0	TOC Timeout	<input type="checkbox"/>	<input type="checkbox"/>	Disabled	-1	10000	10000
5	-1	10500	100	<input type="checkbox"/>	0	TOC Timeout	<input type="checkbox"/>	<input type="checkbox"/>	Disabled	-1	10000	10000
6	-1	10500	100	<input type="checkbox"/>	0	TOC Timeout	<input type="checkbox"/>	<input type="checkbox"/>	Disabled	-1	10000	10000
7	-1	10500	100	<input type="checkbox"/>	0	TOC Timeout	<input type="checkbox"/>	<input type="checkbox"/>	Disabled	-1	10000	10000

Ramp Count 0 Ramp Auto  RAMP\_AUTO Ramp In Source Ramp Transition

Trigger Source A Disabled Trigger Source B Disabled Trigger Source C Disabled  
 FSK Trigger Disabled FSK Deviation 0 Phase Mod. En  RAMP\_PM\_EN

Increment (2s complement)

0	1678	4	0
1	0	5	0
2	0	6	0
3	0	7	0

Figure 9. Continuous Sawtooth Ramp Configuration



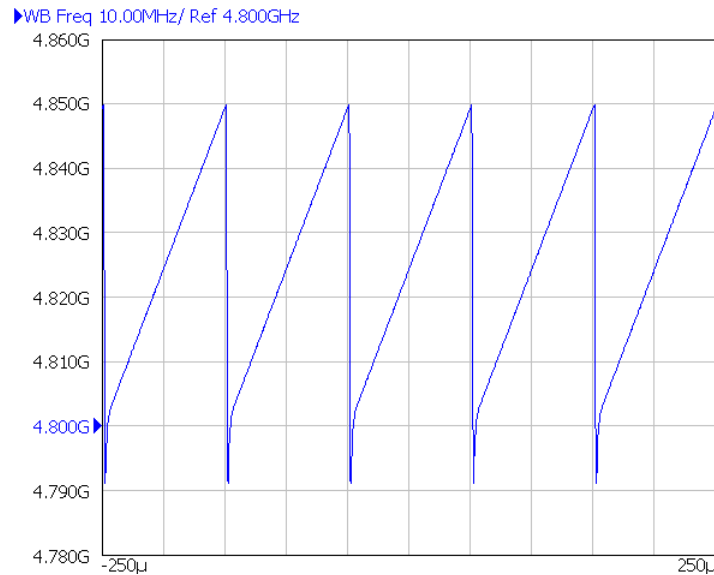

Figure 10. Continuous Sawtooth Ramp Example

### 3.2.3 Continuous Trapezoid Ramp Example

This is a long-ramp example, the ramp duration is 1 ms. RAMPx\_DLY is enabled so that the ramp generator will ramp every 2 phase detector cycles. Output flags are turned on to indicate the start of a ramp.

**Ramps** Ramp Enable  RAMPx\_DLY

Ramp Number	Actual Start Frequency (MHz)	Desired End Frequency (MHz)	Duration (us)	Dly	Next Ramp	Start next ramp after	RST	FL	Flags	Actual End Frequency (MHz)	Length	Increment (dec)
0	9600	9600	500	<input type="checkbox"/>	1	TOC Timeout	<input type="checkbox"/>	<input type="checkbox"/>	Disabled	9600	50000	0
1	9600	9700	1000	<input checked="" type="checkbox"/>	2	TOC Timeout	<input type="checkbox"/>	<input type="checkbox"/>	Flag0	9700.13580322	50000	336
2	9700.13580322	9700	500	<input type="checkbox"/>	3	TOC Timeout	<input type="checkbox"/>	<input type="checkbox"/>	Disabled	9700.13580322	50000	0
3	9700.13580322	9600	1000	<input checked="" type="checkbox"/>	0	TOC Timeout	<input type="checkbox"/>	<input type="checkbox"/>	Flag0 & Fla	9600	50000	-336
4	-1	10500	100	<input type="checkbox"/>	0	TOC Timeout	<input type="checkbox"/>	<input type="checkbox"/>	Disabled	-1	10000	10000
5	-1	10500	100	<input type="checkbox"/>	0	TOC Timeout	<input type="checkbox"/>	<input type="checkbox"/>	Disabled	-1	10000	10000
6	-1	10500	100	<input type="checkbox"/>	0	TOC Timeout	<input type="checkbox"/>	<input type="checkbox"/>	Disabled	-1	10000	10000
7	-1	10500	100	<input type="checkbox"/>	0	TOC Timeout	<input type="checkbox"/>	<input type="checkbox"/>	Disabled	-1	10000	10000

Ramp Count: 0 Ramp Auto:  RAMP\_AUTO Ramp In Source: Ramp Transition

Trigger Source A: Disabled Trigger Source B: Disabled Trigger Source C: Disabled

FSK Trigger: Disabled FSK Deviation: 0 Phase Mod. En:  RAMP\_PM\_EN

Increment (2s complement)

0	0	4	0
1	336	5	0
2	0	6	0
3	1073741488	7	0

Figure 11. Continuous Trapezoid Ramp Configuration

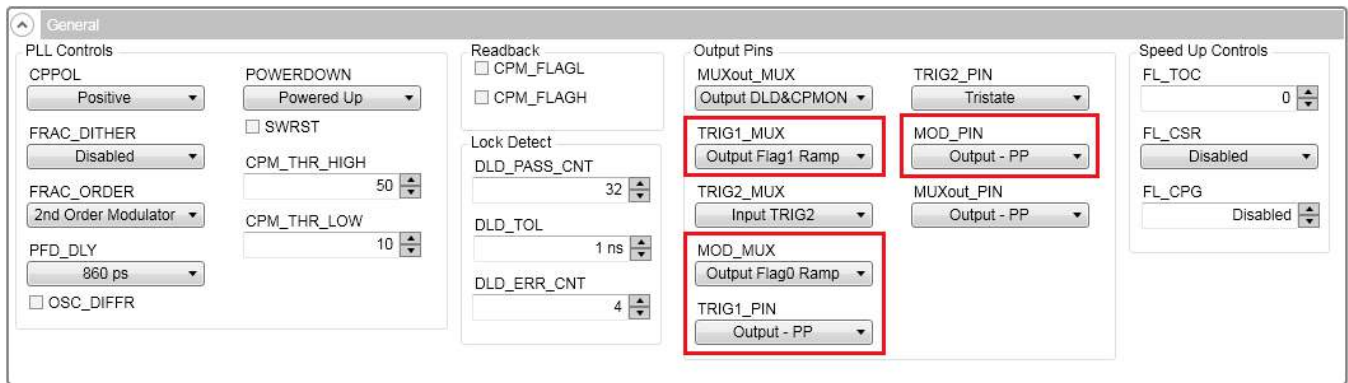

Figure 12. Flag Out Pins Configuration

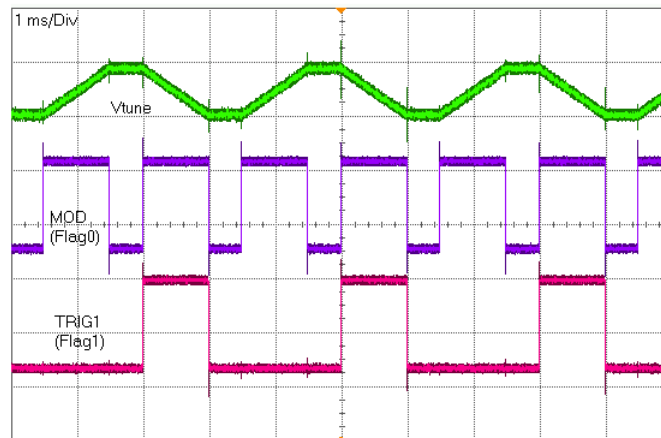

Figure 13. Flags Out Timing

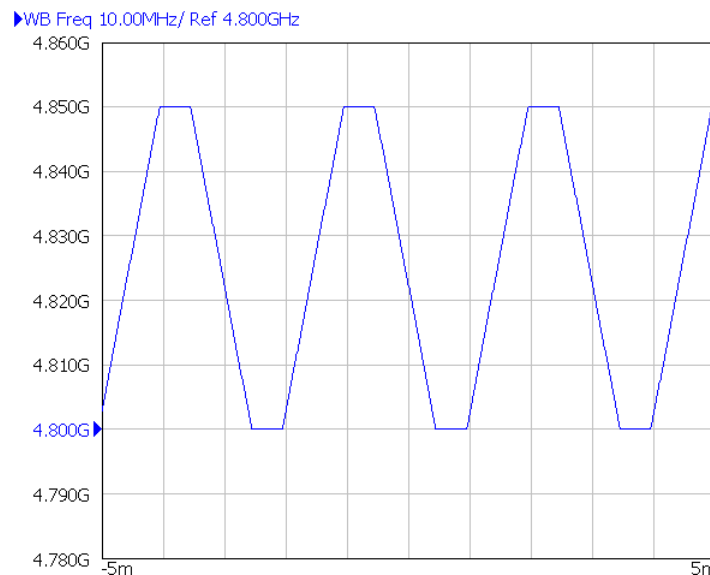

Figure 14. Continuous Trapezoid Ramp Example

### 3.2.4 Register Readback

To read back the written register values,

1. Remove R75 so that the MUXout pin is disconnected from the LED.
2. Populate R68 to connect MUXout pin to USB2ANY.
3. In TICS Pro, set MUXout pin to "Output Readback".

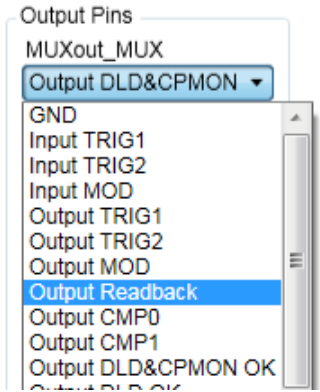

Figure 15. Readback Setting

4. Click on the Register Name that you want to read back.
5. Click the Read Register button to read back the register value.

Register Name	Address/Value	2	2	2	2	1	1	1	1	1	1	1	1	1	1	0	0	0	0	0	0	0	0	0	0
		3	2	1	0	9	8	7	6	5	4	3	2	1	0	9	8	7	6	5	4	3	2	1	0
R38	0x002618	0	0	0	0	0	0	0	0	0	0	1	0	0	1	1	0	0	0	0	1	1	0	0	0
R37	0x002510	0	0	0	0	0	0	0	0	0	0	1	0	0	1	0	1	0	0	0	1	0	0	0	0
R36	0x002408	0	0	0	0	0	0	0	0	0	0	1	0	0	1	0	0	0	0	0	0	1	0	0	0
R35	0x002341	0	0	0	0	0	0	0	0	0	0	1	0	0	0	1	1	0	1	0	0	0	0	0	1
R34	0x002204	0	0	0	0	0	0	0	0	0	0	1	0	0	0	1	0	0	0	0	0	0	1	0	0

Data: 0x002618

Write Register

Read Register

Figure 16. Register Readback

4 Schematic

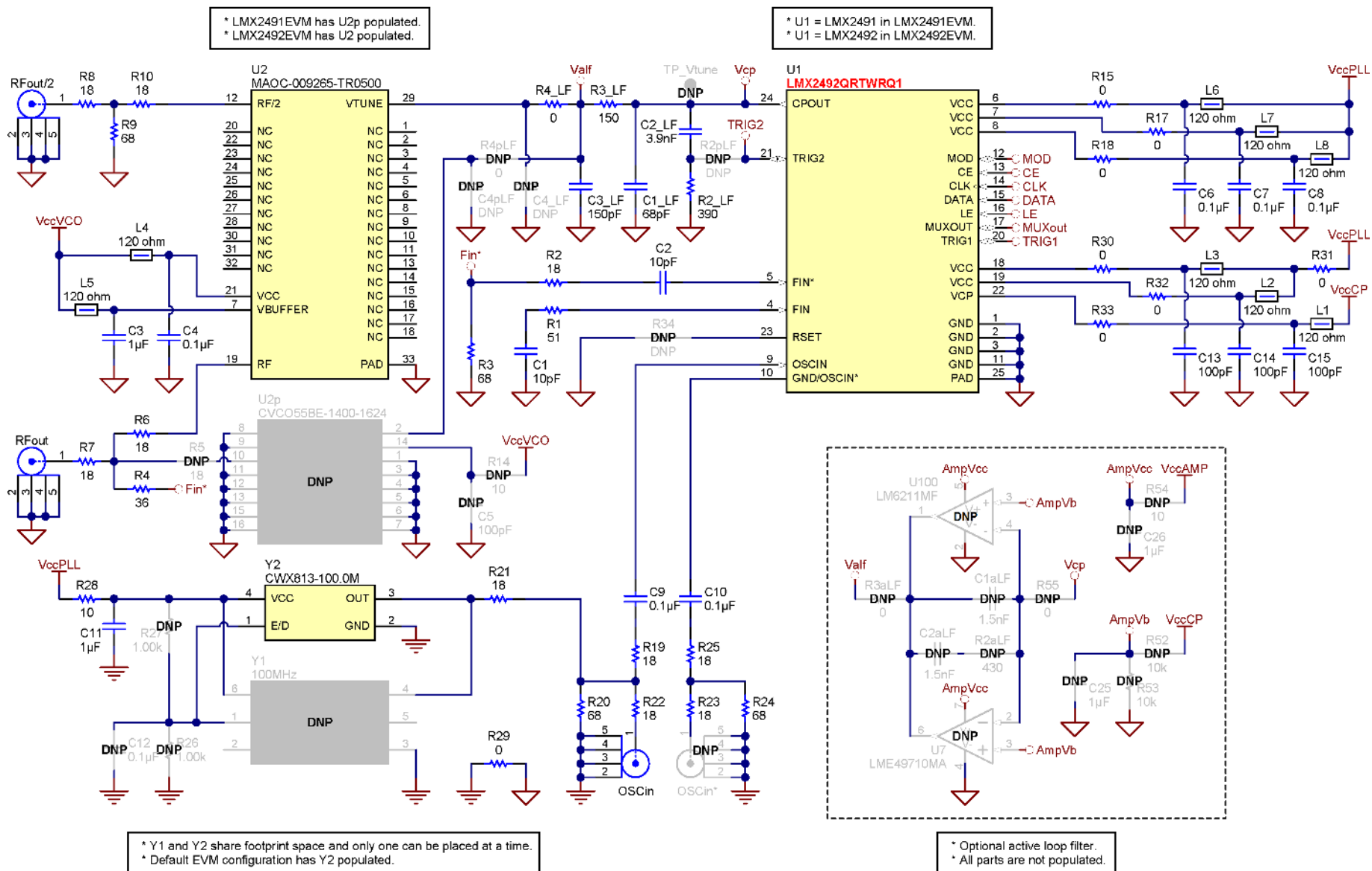

Figure 17. LMX2492EVM Schematic (Page 1)

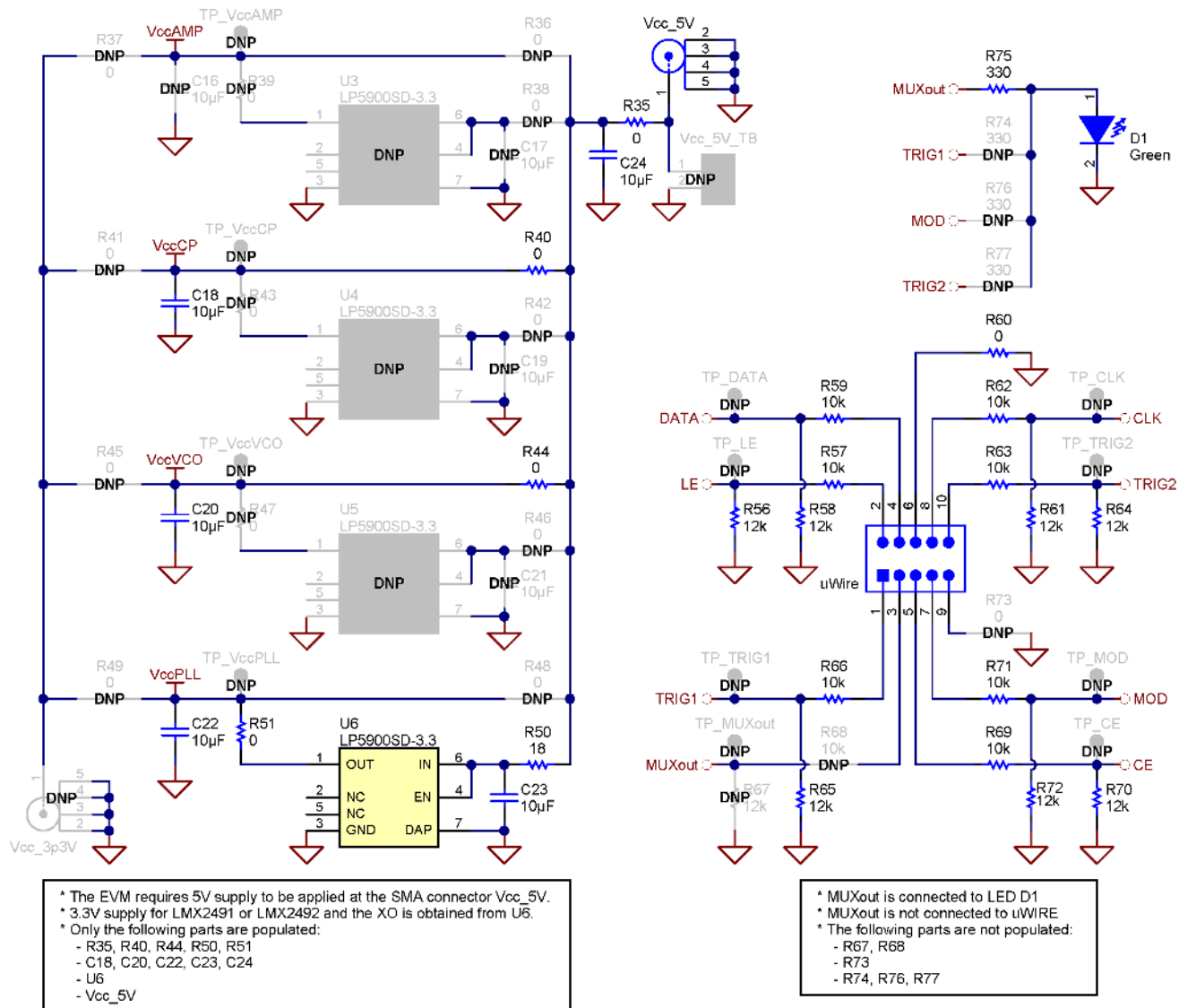

Figure 18. LMX2492EVM Schematic (Page 2)

## 5 PCB Layout and Layer Stack-up

### 5.1 PCB Layer Stack-up

The top layer is 1 oz copper.

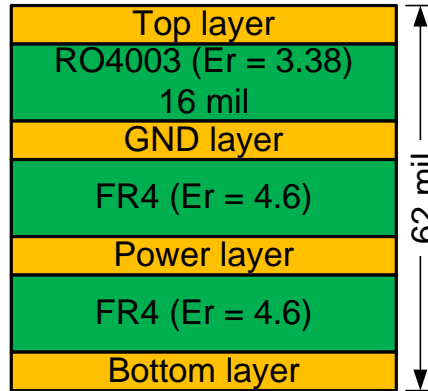

Figure 19. PCB Layer Stack-up

### 5.2 PCB Layout

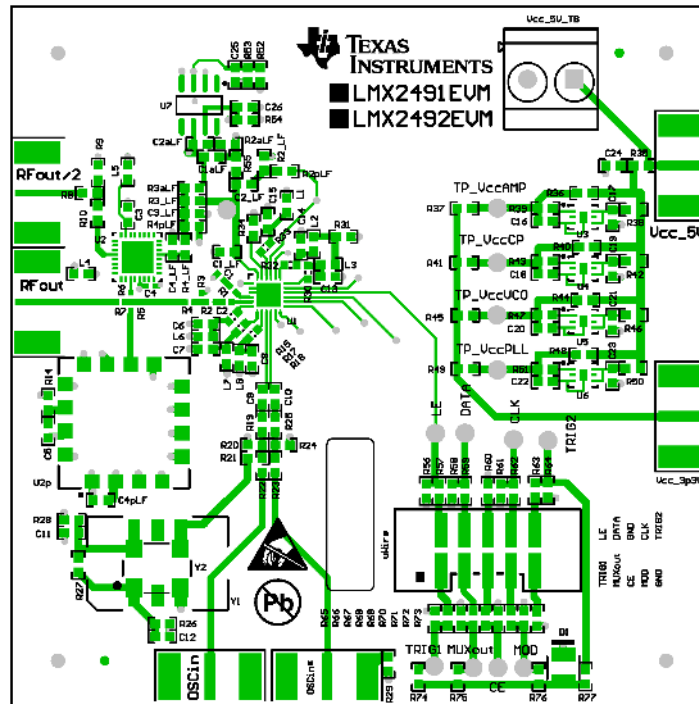

Figure 20. Top Layer

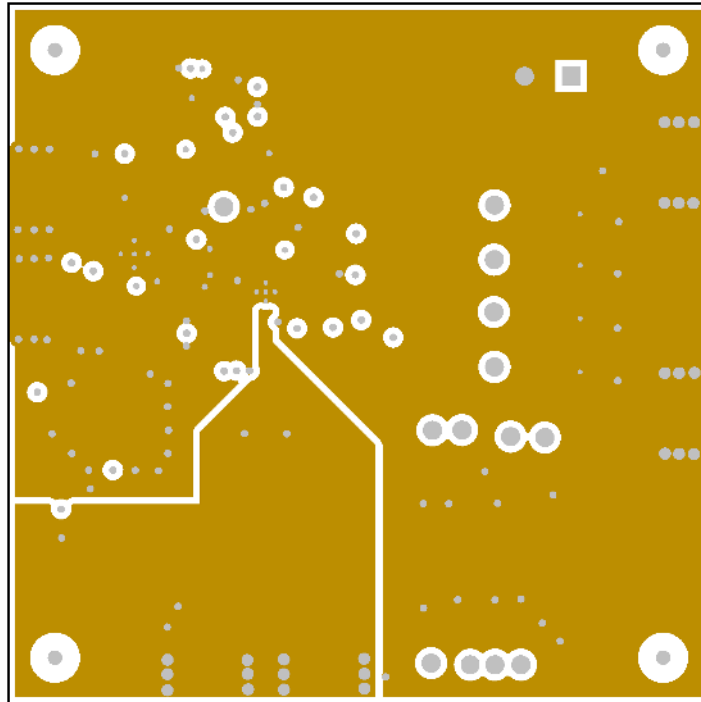

Figure 21. GND Layer

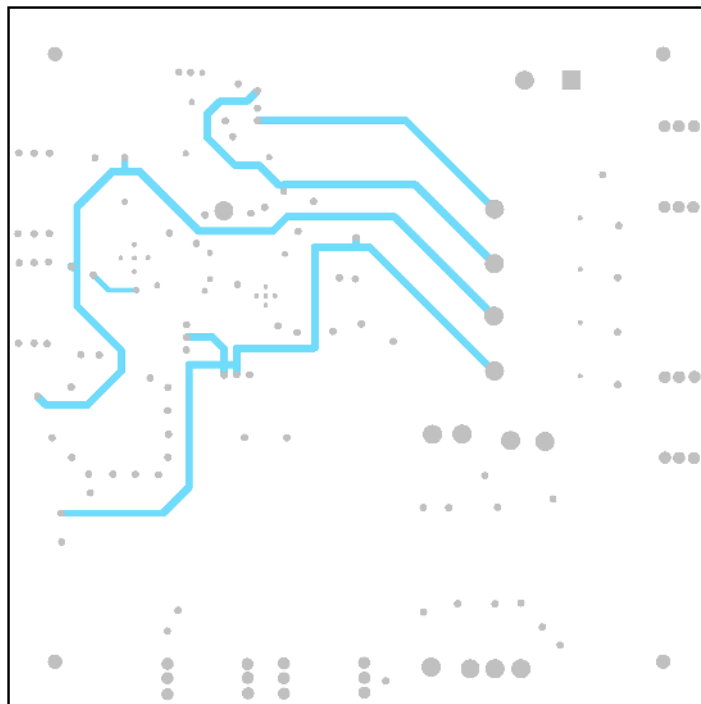
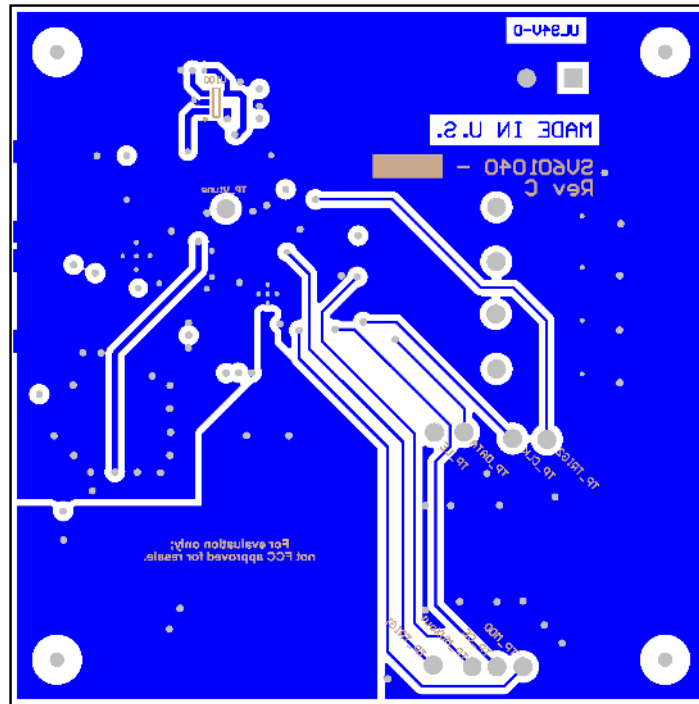

Figure 22. Power Layer



**Figure 23. Bottom Layer**



## 6 Bill of Materials

**Table 2. Bill of Materials**

DESIGNATOR	QUANTITY	DESCRIPTION	PART NUMBER	MANUFACTURER
C1, C2	2	CAP, CERM, 10 pF, 50 V, ±5%, COG/NP0, 0402	500R07S100JV4T	Johanson Technology
C1_LF	1	CAP, CERM, 68 pF, 50 V, ±5%, COG/NP0, 0603	C0603C680J5GACTU	Kemet
C2_LF	1	CAP, CERM, 3900 pF, 50 V, ±5%, COG/NP0, 0603	GRM1885C1H392JA01D	MuRata
C3, C11	2	CAP, CERM, 1 µF, 16 V, ±10%, X7R, 0603	C1608X7R1C105K	TDK
C3_LF	1	CAP, CERM, 150 pF, 50 V, ±5%, COG/NP0, 0603	C0603C151J5GACTU	Kemet
C4	1	CAP, CERM, 0.1 µF, 50 V, ±10%, COG/NP0, 0402	C1005X7R1H104K	TDK
C6, C7, C8, C9, C10	5	CAP, CERM, 0.1 µF, 16 V, ±5%, X7R, 0603	0603YC104JAT2A	AVX
C13, C14, C15	3	CAP, CERM, 100 pF, 50 V, ±5%, COG/NP0, 0603	C0603C101J5GACTU	Kemet
C18, C20, C22, C23, C24	5	CAP, CERM, 10 µF, 6.3 V, ±20%, X5R, 0603	C0603C106M9PACTU	Kemet
D1	1	LED, Green, SMD	SML-LX2832GC-TR	Lumex
L1, L2, L3, L4, L5, L6, L7, L8	8	3 A Ferrite Bead, 120 Ω @ 100 MHz, SMD	BLM18SG121TN1D	MuRata
OSCI <sub>n</sub> , Vcc_5V	2	Connector, SMT, End launch SMA 50 Ω	142-0701-851	Emerson Network Power Connectivity
R1	1	RES, 51 Ω, 5%, 0.063 W, 0402	CRCW040251R0JNED	Vishay-Dale
R2, R6, R7	3	RES, 18 Ω, 5%, 0.063 W, 0402	CRCW040218R0JNED	Vishay-Dale
R2_LF	1	RES, 390 Ω, 5%, 0.1 W, 0603	CRCW0603390RJNEA	Vishay-Dale
R3	1	RES, 68 Ω, 5%, 0.063 W, 0402	CRCW040268R0JNED	Vishay-Dale
R3_LF	1	RES, 150 Ω, 5%, 0.1 W, 0603	CRCW0603150RJNEA	Vishay-Dale
R4	1	RES, 36 Ω, 5%, 0.063 W, 0402	CRCW040236R0JNED	Vishay-Dale
R4_LF, R15, R17, R18, R29, R30, R31, R32, R33, R35, R40, R44, R51, R60	14	RES, 0 Ω, 5%, 0.1 W, 0603	CRCW06030000Z0EA	Vishay-Dale
R8, R10, R19, R21, R22, R23, R25, R50	8	RES, 18 Ω, 5%, 0.1 W, 0603	CRCW060318R0JNEA	Vishay-Dale
R9, R20, R24	3	RES, 68 Ω, 5%, 0.1 W, 0603	CRCW060368R0JNEA	Vishay-Dale
R28	1	RES, 10 Ω, 5%, 0.1 W, 0603	CRCW060310R0JNEA	Vishay-Dale
R56, R58, R61, R64, R65, R70, R72	7	RES, 12k Ω, 5%, 0.1 W, 0603	CRCW060312K0JNEA	Vishay-Dale
R57, R59, R62, R63, R66, R69, R71	7	RES, 10k Ω, 5%, 0.1 W, 0603	CRCW060310K0JNEA	Vishay-Dale
R75	1	RES, 330 Ω, 5%, 0.1 W, 0603	RC0603JR-07330RL	Yageo America
RFout, RFout/2	2	Connector, SMT, End launch SMA 50 Ω	142-0701-851	Emerson Network Power
U1	1	500 MHz to 14 GHz Wideband, Low Noise Fractional N PLL With Ramp/Chirp Generation	LMX2492QRTWRQ1	Texas Instruments
U2	1	Voltage Controlled Oscillator 9.4 - 10.8 GHz	MAOC-009265-TR0500	MACOM
U6	1	Ultra Low Noise, 150 mA Linear Regulator for RF/Analog Circuits Requires No Bypass Capacitor	LP5900SD-3.3	Texas Instruments
uWire	1	Header (shrouded), 100mil, 5x2, Gold plated, SMD	52601-S10-8LF	FCI
Y2	1	OSC 100.0000 MHz 3.3 V ±25 PPM SMD	CWX813-100.0M	Connor-Winfield

## 7 Troubleshooting Guide

If the EVM does not work as expected, use the following chart to identify potential root causes. Couples of thing to note:

- Make modifications to the EVM or change the default settings until AFTER it is verified to be working.
- Register readback requires the correct hardware and software setup. See [Section 3.2.4](#) for details.
- The POR current of the LMX2492EVM is approximately 175 mA.
- The powerdown current of the LMX2492EVM is approximately 175 mA.

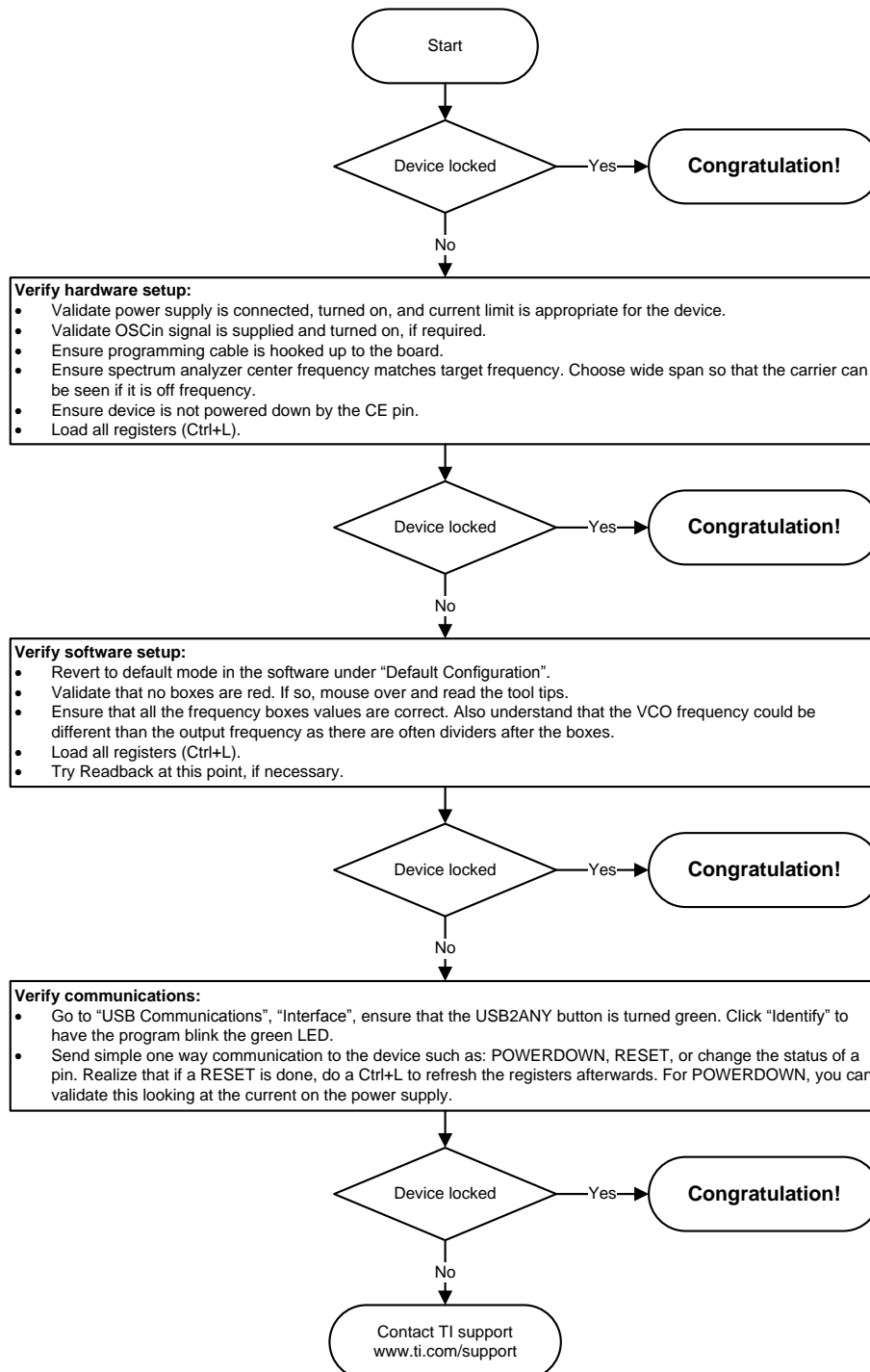
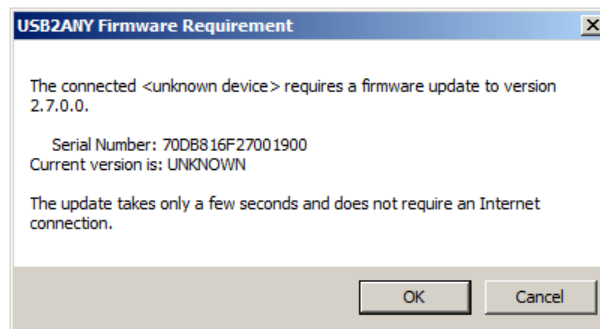

**Figure 24. Troubleshooting Guide**

## USB2ANY Firmware Upgrade

Usually when the USB2ANY module is used at the first time, TICS Pro will request for a firmware update. Simply follow the pop-up instructions to complete the update. This is necessary to ensure that the USB connection between the PC and the USB2ANY module is properly setup, otherwise the programming to LMX2492EVM will not be successful.

1. When you see this message, click the "OK" button.



**Figure 25. Firmware Requirement**

2. Next, follow the on-screen procedure.

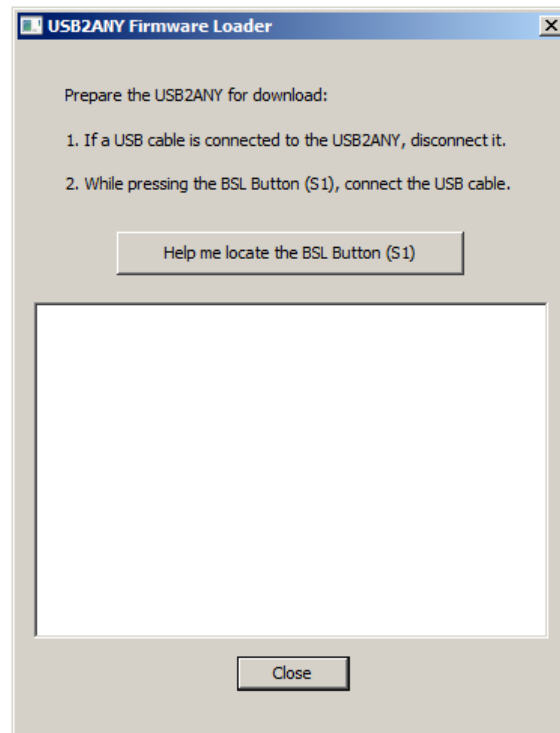

**Figure 26. Firmware Loader**

3. If you don't know the location of the BSL button, click the long button in the middle of the screen.

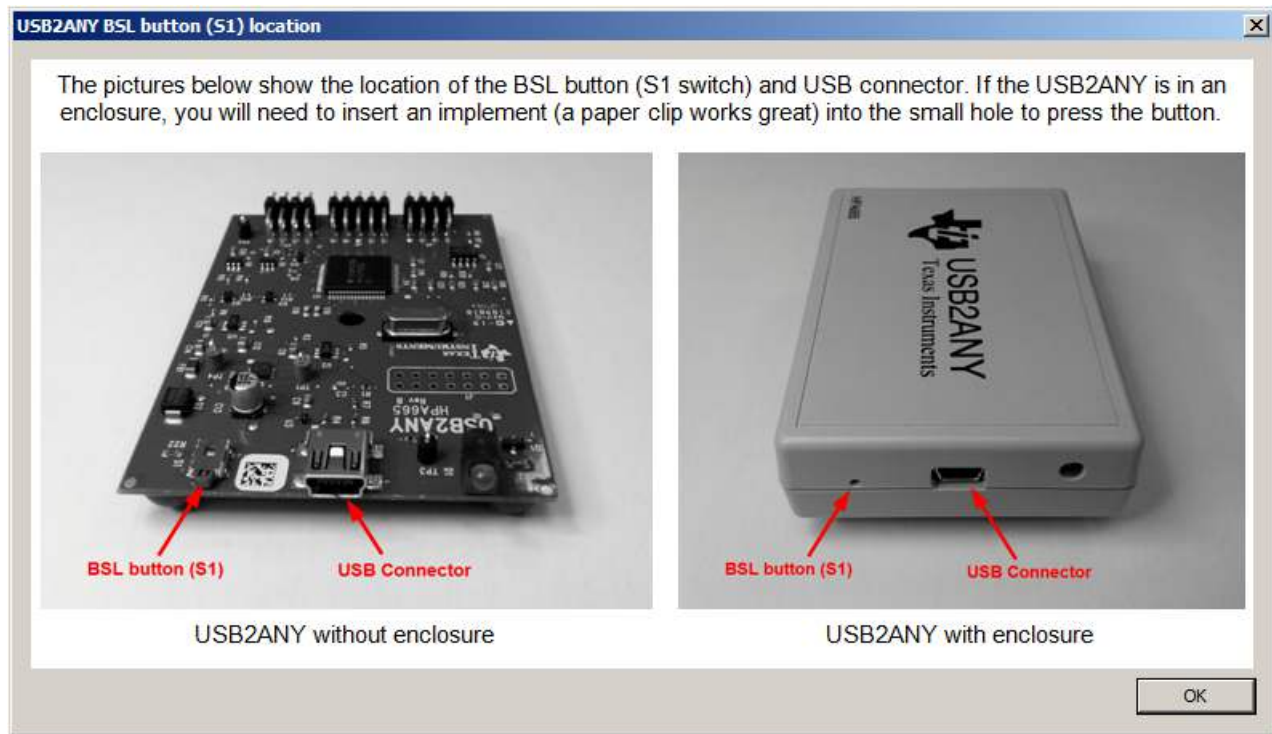

Figure 27. BSL Button

4. Click the "OK" button to go back to the previous screen. Follow the on-screen procedure until the below screen is pop-up.

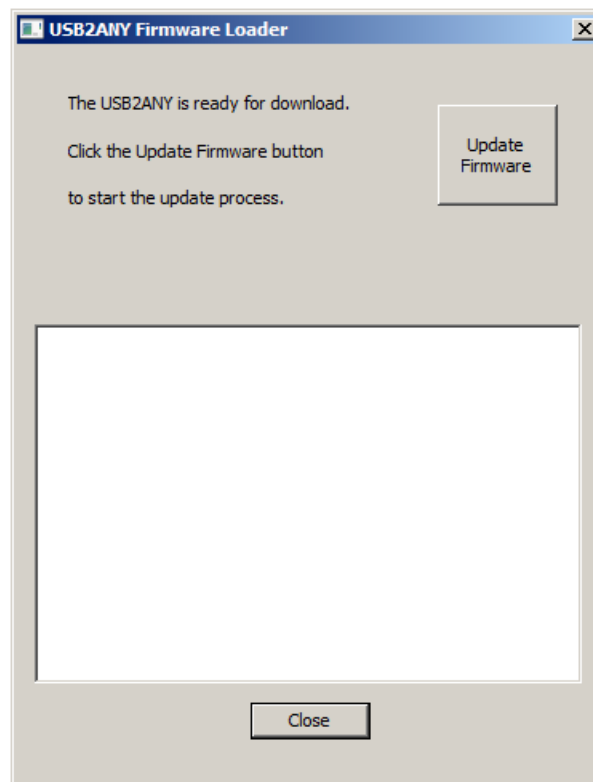
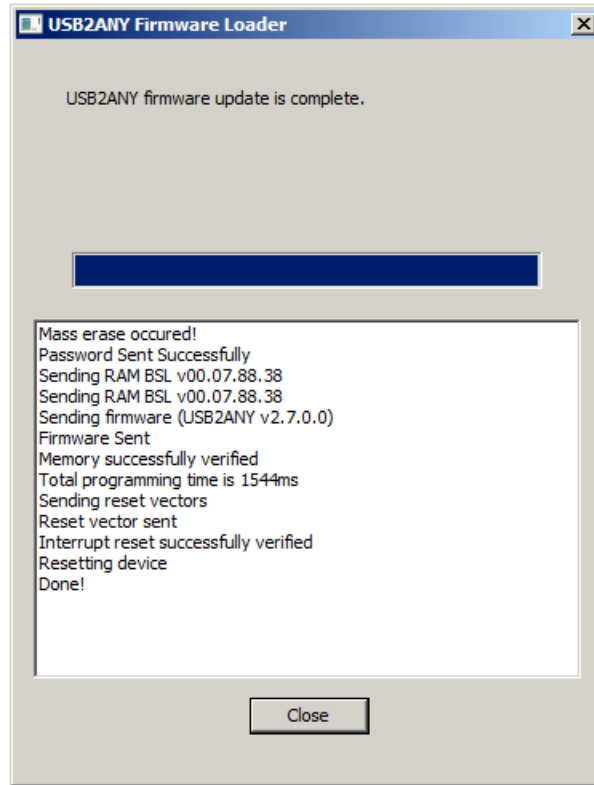

Figure 28. Update Firmware

5. Click the "Upgrade Firmware" button, the firmware will be upgrading. Click the "Close" button after it is done.



**Figure 29. Firmware Update Completed**

6. Check the USB connection in TICS Pro by clicking USB communications → Interface. Make sure the USB Connected button is turned green.

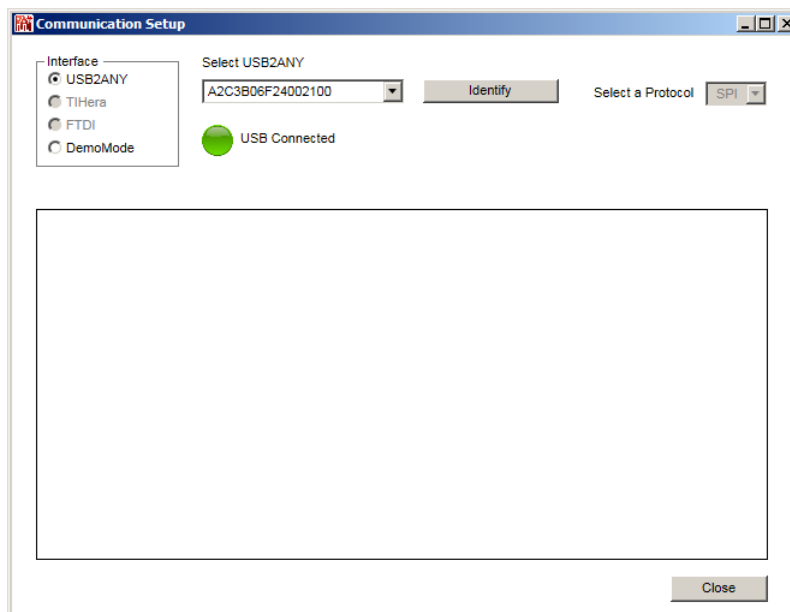

**Figure 30. USB Communications**

## Using Different Reference Clock

There are different options to provide a reference clock to LMX2492EVM. By default, the EVM is configured for the on-board single-ended XO clock. To use external clock, R21 and R28 must be removed. If external differential clock is desired, OSCin\* SMA connector is required.

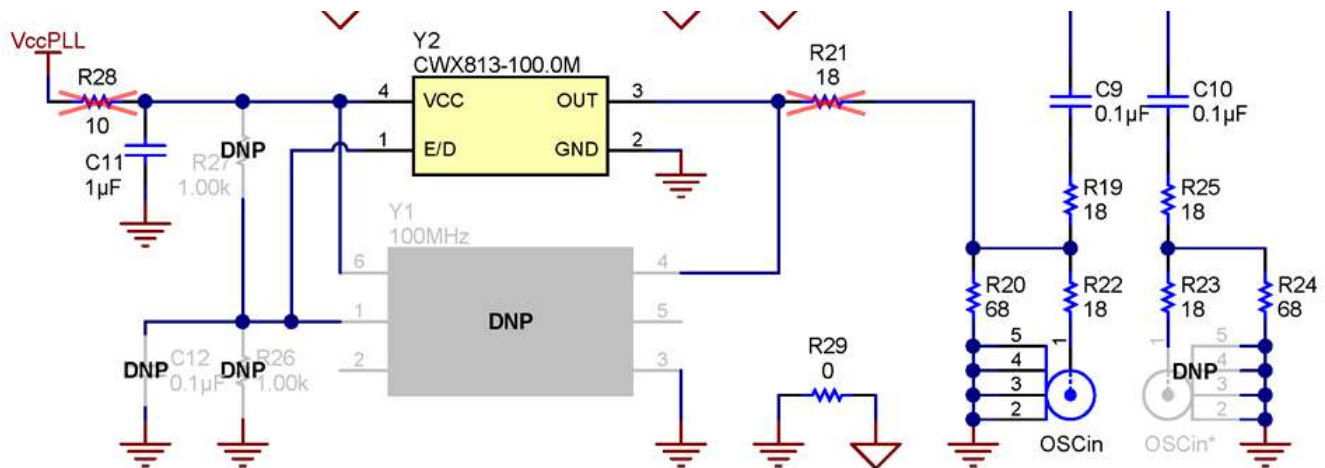

**Figure 31. Reference Clock Input Configuration**

## Revision History

NOTE: Page numbers for previous revisions may differ from page numbers in the current version.

<b>Changes from D Revision (September 2015) to E Revision</b>	<b>Page</b>
• Changed to use on-board XO .....	4
• Changed to use TICS Pro to program the device.....	4
• Changed VCO frequency and VCO gain.....	6
• Changed U2 part number.....	17
• Added Appendix A.....	19
• Added Appendix B.....	22

## STANDARD TERMS FOR EVALUATION MODULES

1. *Delivery:* TI delivers TI evaluation boards, kits, or modules, including any accompanying demonstration software, components, and/or documentation which may be provided together or separately (collectively, an "EVM" or "EVMs") to the User ("User") in accordance with the terms set forth herein. User's acceptance of the EVM is expressly subject to the following terms.
  - 1.1 EVMs are intended solely for product or software developers for use in a research and development setting to facilitate feasibility evaluation, experimentation, or scientific analysis of TI semiconductor products. EVMs have no direct function and are not finished products. EVMs shall not be directly or indirectly assembled as a part or subassembly in any finished product. For clarification, any software or software tools provided with the EVM ("Software") shall not be subject to the terms and conditions set forth herein but rather shall be subject to the applicable terms that accompany such Software
  - 1.2 EVMs are not intended for consumer or household use. EVMs may not be sold, sublicensed, leased, rented, loaned, assigned, or otherwise distributed for commercial purposes by Users, in whole or in part, or used in any finished product or production system.
2. *Limited Warranty and Related Remedies/Disclaimers:*
  - 2.1 These terms do not apply to Software. The warranty, if any, for Software is covered in the applicable Software License Agreement.
  - 2.2 TI warrants that the TI EVM will conform to TI's published specifications for ninety (90) days after the date TI delivers such EVM to User. Notwithstanding the foregoing, TI shall not be liable for a nonconforming EVM if (a) the nonconformity was caused by neglect, misuse or mistreatment by an entity other than TI, including improper installation or testing, or for any EVMs that have been altered or modified in any way by an entity other than TI, (b) the nonconformity resulted from User's design, specifications or instructions for such EVMs or improper system design, or (c) User has not paid on time. Testing and other quality control techniques are used to the extent TI deems necessary. TI does not test all parameters of each EVM. User's claims against TI under this Section 2 are void if User fails to notify TI of any apparent defects in the EVMs within ten (10) business days after delivery, or of any hidden defects with ten (10) business days after the defect has been detected.
  - 2.3 TI's sole liability shall be at its option to repair or replace EVMs that fail to conform to the warranty set forth above, or credit User's account for such EVM. TI's liability under this warranty shall be limited to EVMs that are returned during the warranty period to the address designated by TI and that are determined by TI not to conform to such warranty. If TI elects to repair or replace such EVM, TI shall have a reasonable time to repair such EVM or provide replacements. Repaired EVMs shall be warranted for the remainder of the original warranty period. Replaced EVMs shall be warranted for a new full ninety (90) day warranty period.
3. *Regulatory Notices:*
  - 3.1 *United States*
    - 3.1.1 *Notice applicable to EVMs not FCC-Approved:*

**FCC NOTICE:** This kit is designed to allow product developers to evaluate electronic components, circuitry, or software associated with the kit to determine whether to incorporate such items in a finished product and software developers to write software applications for use with the end product. This kit is not a finished product and when assembled may not be resold or otherwise marketed unless all required FCC equipment authorizations are first obtained. Operation is subject to the condition that this product not cause harmful interference to licensed radio stations and that this product accept harmful interference. Unless the assembled kit is designed to operate under part 15, part 18 or part 95 of this chapter, the operator of the kit must operate under the authority of an FCC license holder or must secure an experimental authorization under part 5 of this chapter.
    - 3.1.2 *For EVMs annotated as FCC – FEDERAL COMMUNICATIONS COMMISSION Part 15 Compliant:*

### CAUTION

This device complies with part 15 of the FCC Rules. Operation is subject to the following two conditions: (1) This device may not cause harmful interference, and (2) this device must accept any interference received, including interference that may cause undesired operation.

Changes or modifications not expressly approved by the party responsible for compliance could void the user's authority to operate the equipment.

### FCC Interference Statement for Class A EVM devices

*NOTE: This equipment has been tested and found to comply with the limits for a Class A digital device, pursuant to part 15 of the FCC Rules. These limits are designed to provide reasonable protection against harmful interference when the equipment is operated in a commercial environment. This equipment generates, uses, and can radiate radio frequency energy and, if not installed and used in accordance with the instruction manual, may cause harmful interference to radio communications. Operation of this equipment in a residential area is likely to cause harmful interference in which case the user will be required to correct the interference at his own expense.*



## FCC Interference Statement for Class B EVM devices

*NOTE: This equipment has been tested and found to comply with the limits for a Class B digital device, pursuant to part 15 of the FCC Rules. These limits are designed to provide reasonable protection against harmful interference in a residential installation. This equipment generates, uses and can radiate radio frequency energy and, if not installed and used in accordance with the instructions, may cause harmful interference to radio communications. However, there is no guarantee that interference will not occur in a particular installation. If this equipment does cause harmful interference to radio or television reception, which can be determined by turning the equipment off and on, the user is encouraged to try to correct the interference by one or more of the following measures:*

- Reorient or relocate the receiving antenna.
- Increase the separation between the equipment and receiver.
- Connect the equipment into an outlet on a circuit different from that to which the receiver is connected.
- Consult the dealer or an experienced radio/TV technician for help.

### 3.2 Canada

3.2.1 For EVMs issued with an Industry Canada Certificate of Conformance to RSS-210 or RSS-247

#### Concerning EVMs Including Radio Transmitters:

This device complies with Industry Canada license-exempt RSSs. Operation is subject to the following two conditions:

(1) this device may not cause interference, and (2) this device must accept any interference, including interference that may cause undesired operation of the device.

#### Concernant les EVMs avec appareils radio:

Le présent appareil est conforme aux CNR d'Industrie Canada applicables aux appareils radio exempts de licence. L'exploitation est autorisée aux deux conditions suivantes: (1) l'appareil ne doit pas produire de brouillage, et (2) l'utilisateur de l'appareil doit accepter tout brouillage radioélectrique subi, même si le brouillage est susceptible d'en compromettre le fonctionnement.

#### Concerning EVMs Including Detachable Antennas:

Under Industry Canada regulations, this radio transmitter may only operate using an antenna of a type and maximum (or lesser) gain approved for the transmitter by Industry Canada. To reduce potential radio interference to other users, the antenna type and its gain should be so chosen that the equivalent isotropically radiated power (e.i.r.p.) is not more than that necessary for successful communication. This radio transmitter has been approved by Industry Canada to operate with the antenna types listed in the user guide with the maximum permissible gain and required antenna impedance for each antenna type indicated. Antenna types not included in this list, having a gain greater than the maximum gain indicated for that type, are strictly prohibited for use with this device.

#### Concernant les EVMs avec antennes détachables

Conformément à la réglementation d'Industrie Canada, le présent émetteur radio peut fonctionner avec une antenne d'un type et d'un gain maximal (ou inférieur) approuvé pour l'émetteur par Industrie Canada. Dans le but de réduire les risques de brouillage radioélectrique à l'intention des autres utilisateurs, il faut choisir le type d'antenne et son gain de sorte que la puissance isotrope rayonnée équivalente (p.i.r.e.) ne dépasse pas l'intensité nécessaire à l'établissement d'une communication satisfaisante. Le présent émetteur radio a été approuvé par Industrie Canada pour fonctionner avec les types d'antenne énumérés dans le manuel d'usage et ayant un gain admissible maximal et l'impédance requise pour chaque type d'antenne. Les types d'antenne non inclus dans cette liste, ou dont le gain est supérieur au gain maximal indiqué, sont strictement interdits pour l'exploitation de l'émetteur.

### 3.3 Japan

3.3.1 *Notice for EVMs delivered in Japan:* Please see [http://www.tij.co.jp/lstds/ti\\_ja/general/eStore/notice\\_01.page](http://www.tij.co.jp/lstds/ti_ja/general/eStore/notice_01.page) 日本国内に輸入される評価用キット、ボードについては、次のところをご覧ください。  
[http://www.tij.co.jp/lstds/ti\\_ja/general/eStore/notice\\_01.page](http://www.tij.co.jp/lstds/ti_ja/general/eStore/notice_01.page)

3.3.2 *Notice for Users of EVMs Considered "Radio Frequency Products" in Japan:* EVMs entering Japan may not be certified by TI as conforming to Technical Regulations of Radio Law of Japan.

If User uses EVMs in Japan, not certified to Technical Regulations of Radio Law of Japan, User is required to follow the instructions set forth by Radio Law of Japan, which includes, but is not limited to, the instructions below with respect to EVMs (which for the avoidance of doubt are stated strictly for convenience and should be verified by User):

1. Use EVMs in a shielded room or any other test facility as defined in the notification #173 issued by Ministry of Internal Affairs and Communications on March 28, 2006, based on Sub-section 1.1 of Article 6 of the Ministry's Rule for Enforcement of Radio Law of Japan,
2. Use EVMs only after User obtains the license of Test Radio Station as provided in Radio Law of Japan with respect to EVMs, or
3. Use of EVMs only after User obtains the Technical Regulations Conformity Certification as provided in Radio Law of Japan with respect to EVMs. Also, do not transfer EVMs, unless User gives the same notice above to the transferee. Please note that if User does not follow the instructions above, User will be subject to penalties of Radio Law of Japan.

【無線電波を送信する製品の開発キットをお使いになる際の注意事項】 開発キットの中には技術基準適合証明を受けていないものがあります。技術適合証明を受けていないものご使用に際しては、電波法遵守のため、以下のいずれかの措置を取っていただく必要がありますのでご注意ください。

1. 電波法施行規則第6条第1項第1号に基づく平成18年3月28日総務省告示第173号で定められた電波暗室等の試験設備でご使用いただく。
2. 実験局の免許を取得後ご使用いただく。
3. 技術基準適合証明を取得後ご使用いただく。

なお、本製品は、上記の「ご使用にあたっての注意」を譲渡先、移転先に通知しない限り、譲渡、移転できないものとします。

上記を遵守頂けない場合は、電波法の罰則が適用される可能性があることをご留意ください。日本テキサス・インスツルメンツ株式会社  
東京都新宿区西新宿 6 丁目 2 4 番 1 号  
西新宿三井ビル

3.3.3 *Notice for EVMs for Power Line Communication:* Please see [http://www.tij.co.jp/llds/ti\\_ja/general/eStore/notice\\_02.page](http://www.tij.co.jp/llds/ti_ja/general/eStore/notice_02.page)  
電力線搬送波通信についての開発キットをお使いになる際の注意事項については、次のところをご覧ください。 [http://www.tij.co.jp/llds/ti\\_ja/general/eStore/notice\\_02.page](http://www.tij.co.jp/llds/ti_ja/general/eStore/notice_02.page)

#### 3.4 *European Union*

##### 3.4.1 *For EVMs subject to EU Directive 2014/30/EU (Electromagnetic Compatibility Directive):*

This is a class A product intended for use in environments other than domestic environments that are connected to a low-voltage power-supply network that supplies buildings used for domestic purposes. In a domestic environment this product may cause radio interference in which case the user may be required to take adequate measures.

#### 4 *EVM Use Restrictions and Warnings:*

4.1 EVMS ARE NOT FOR USE IN FUNCTIONAL SAFETY AND/OR SAFETY CRITICAL EVALUATIONS, INCLUDING BUT NOT LIMITED TO EVALUATIONS OF LIFE SUPPORT APPLICATIONS.

4.2 User must read and apply the user guide and other available documentation provided by TI regarding the EVM prior to handling or using the EVM, including without limitation any warning or restriction notices. The notices contain important safety information related to, for example, temperatures and voltages.

##### 4.3 *Safety-Related Warnings and Restrictions:*

4.3.1 User shall operate the EVM within TI's recommended specifications and environmental considerations stated in the user guide, other available documentation provided by TI, and any other applicable requirements and employ reasonable and customary safeguards. Exceeding the specified performance ratings and specifications (including but not limited to input and output voltage, current, power, and environmental ranges) for the EVM may cause personal injury or death, or property damage. If there are questions concerning performance ratings and specifications, User should contact a TI field representative prior to connecting interface electronics including input power and intended loads. Any loads applied outside of the specified output range may also result in unintended and/or inaccurate operation and/or possible permanent damage to the EVM and/or interface electronics. Please consult the EVM user guide prior to connecting any load to the EVM output. If there is uncertainty as to the load specification, please contact a TI field representative. During normal operation, even with the inputs and outputs kept within the specified allowable ranges, some circuit components may have elevated case temperatures. These components include but are not limited to linear regulators, switching transistors, pass transistors, current sense resistors, and heat sinks, which can be identified using the information in the associated documentation. When working with the EVM, please be aware that the EVM may become very warm.

4.3.2 EVMs are intended solely for use by technically qualified, professional electronics experts who are familiar with the dangers and application risks associated with handling electrical mechanical components, systems, and subsystems. User assumes all responsibility and liability for proper and safe handling and use of the EVM by User or its employees, affiliates, contractors or designees. User assumes all responsibility and liability to ensure that any interfaces (electronic and/or mechanical) between the EVM and any human body are designed with suitable isolation and means to safely limit accessible leakage currents to minimize the risk of electrical shock hazard. User assumes all responsibility and liability for any improper or unsafe handling or use of the EVM by User or its employees, affiliates, contractors or designees.

4.4 User assumes all responsibility and liability to determine whether the EVM is subject to any applicable international, federal, state, or local laws and regulations related to User's handling and use of the EVM and, if applicable, User assumes all responsibility and liability for compliance in all respects with such laws and regulations. User assumes all responsibility and liability for proper disposal and recycling of the EVM consistent with all applicable international, federal, state, and local requirements.

5. *Accuracy of Information:* To the extent TI provides information on the availability and function of EVMs, TI attempts to be as accurate as possible. However, TI does not warrant the accuracy of EVM descriptions, EVM availability or other information on its websites as accurate, complete, reliable, current, or error-free.

6. *Disclaimers:*
- 6.1 EXCEPT AS SET FORTH ABOVE, EVMS AND ANY MATERIALS PROVIDED WITH THE EVM (INCLUDING, BUT NOT LIMITED TO, REFERENCE DESIGNS AND THE DESIGN OF THE EVM ITSELF) ARE PROVIDED "AS IS" AND "WITH ALL FAULTS." TI DISCLAIMS ALL OTHER WARRANTIES, EXPRESS OR IMPLIED, REGARDING SUCH ITEMS, INCLUDING BUT NOT LIMITED TO ANY EPIDEMIC FAILURE WARRANTY OR IMPLIED WARRANTIES OF MERCHANTABILITY OR FITNESS FOR A PARTICULAR PURPOSE OR NON-INFRINGEMENT OF ANY THIRD PARTY PATENTS, COPYRIGHTS, TRADE SECRETS OR OTHER INTELLECTUAL PROPERTY RIGHTS.
- 6.2 EXCEPT FOR THE LIMITED RIGHT TO USE THE EVM SET FORTH HEREIN, NOTHING IN THESE TERMS SHALL BE CONSTRUED AS GRANTING OR CONFERRING ANY RIGHTS BY LICENSE, PATENT, OR ANY OTHER INDUSTRIAL OR INTELLECTUAL PROPERTY RIGHT OF TI, ITS SUPPLIERS/LICENSORS OR ANY OTHER THIRD PARTY, TO USE THE EVM IN ANY FINISHED END-USER OR READY-TO-USE FINAL PRODUCT, OR FOR ANY INVENTION, DISCOVERY OR IMPROVEMENT, REGARDLESS OF WHEN MADE, CONCEIVED OR ACQUIRED.
7. *USER'S INDEMNITY OBLIGATIONS AND REPRESENTATIONS.* USER WILL DEFEND, INDEMNIFY AND HOLD TI, ITS LICENSORS AND THEIR REPRESENTATIVES HARMLESS FROM AND AGAINST ANY AND ALL CLAIMS, DAMAGES, LOSSES, EXPENSES, COSTS AND LIABILITIES (COLLECTIVELY, "CLAIMS") ARISING OUT OF OR IN CONNECTION WITH ANY HANDLING OR USE OF THE EVM THAT IS NOT IN ACCORDANCE WITH THESE TERMS. THIS OBLIGATION SHALL APPLY WHETHER CLAIMS ARISE UNDER STATUTE, REGULATION, OR THE LAW OF TORT, CONTRACT OR ANY OTHER LEGAL THEORY, AND EVEN IF THE EVM FAILS TO PERFORM AS DESCRIBED OR EXPECTED.
8. *Limitations on Damages and Liability:*
- 8.1 *General Limitations.* IN NO EVENT SHALL TI BE LIABLE FOR ANY SPECIAL, COLLATERAL, INDIRECT, PUNITIVE, INCIDENTAL, CONSEQUENTIAL, OR EXEMPLARY DAMAGES IN CONNECTION WITH OR ARISING OUT OF THESE TERMS OR THE USE OF THE EVMS , REGARDLESS OF WHETHER TI HAS BEEN ADVISED OF THE POSSIBILITY OF SUCH DAMAGES. EXCLUDED DAMAGES INCLUDE, BUT ARE NOT LIMITED TO, COST OF REMOVAL OR REINSTALLATION, ANCILLARY COSTS TO THE PROCUREMENT OF SUBSTITUTE GOODS OR SERVICES, RETESTING, OUTSIDE COMPUTER TIME, LABOR COSTS, LOSS OF GOODWILL, LOSS OF PROFITS, LOSS OF SAVINGS, LOSS OF USE, LOSS OF DATA, OR BUSINESS INTERRUPTION. NO CLAIM, SUIT OR ACTION SHALL BE BROUGHT AGAINST TI MORE THAN TWELVE (12) MONTHS AFTER THE EVENT THAT GAVE RISE TO THE CAUSE OF ACTION HAS OCCURRED.
- 8.2 *Specific Limitations.* IN NO EVENT SHALL TI'S AGGREGATE LIABILITY FROM ANY USE OF AN EVM PROVIDED HEREUNDER, INCLUDING FROM ANY WARRANTY, INDEMNITY OR OTHER OBLIGATION ARISING OUT OF OR IN CONNECTION WITH THESE TERMS, , EXCEED THE TOTAL AMOUNT PAID TO TI BY USER FOR THE PARTICULAR EVM(S) AT ISSUE DURING THE PRIOR TWELVE (12) MONTHS WITH RESPECT TO WHICH LOSSES OR DAMAGES ARE CLAIMED. THE EXISTENCE OF MORE THAN ONE CLAIM SHALL NOT ENLARGE OR EXTEND THIS LIMIT.
9. *Return Policy.* Except as otherwise provided, TI does not offer any refunds, returns, or exchanges. Furthermore, no return of EVM(s) will be accepted if the package has been opened and no return of the EVM(s) will be accepted if they are damaged or otherwise not in a resalable condition. If User feels it has been incorrectly charged for the EVM(s) it ordered or that delivery violates the applicable order, User should contact TI. All refunds will be made in full within thirty (30) working days from the return of the components(s), excluding any postage or packaging costs.
10. *Governing Law:* These terms and conditions shall be governed by and interpreted in accordance with the laws of the State of Texas, without reference to conflict-of-laws principles. User agrees that non-exclusive jurisdiction for any dispute arising out of or relating to these terms and conditions lies within courts located in the State of Texas and consents to venue in Dallas County, Texas. Notwithstanding the foregoing, any judgment may be enforced in any United States or foreign court, and TI may seek injunctive relief in any United States or foreign court.

## IMPORTANT NOTICE FOR TI DESIGN INFORMATION AND RESOURCES

Texas Instruments Incorporated ("TI") technical, application or other design advice, services or information, including, but not limited to, reference designs and materials relating to evaluation modules, (collectively, "TI Resources") are intended to assist designers who are developing applications that incorporate TI products; by downloading, accessing or using any particular TI Resource in any way, you (individually or, if you are acting on behalf of a company, your company) agree to use it solely for this purpose and subject to the terms of this Notice.

TI's provision of TI Resources does not expand or otherwise alter TI's applicable published warranties or warranty disclaimers for TI products, and no additional obligations or liabilities arise from TI providing such TI Resources. TI reserves the right to make corrections, enhancements, improvements and other changes to its TI Resources.

You understand and agree that you remain responsible for using your independent analysis, evaluation and judgment in designing your applications and that you have full and exclusive responsibility to assure the safety of your applications and compliance of your applications (and of all TI products used in or for your applications) with all applicable regulations, laws and other applicable requirements. You represent that, with respect to your applications, you have all the necessary expertise to create and implement safeguards that (1) anticipate dangerous consequences of failures, (2) monitor failures and their consequences, and (3) lessen the likelihood of failures that might cause harm and take appropriate actions. You agree that prior to using or distributing any applications that include TI products, you will thoroughly test such applications and the functionality of such TI products as used in such applications. TI has not conducted any testing other than that specifically described in the published documentation for a particular TI Resource.

You are authorized to use, copy and modify any individual TI Resource only in connection with the development of applications that include the TI product(s) identified in such TI Resource. NO OTHER LICENSE, EXPRESS OR IMPLIED, BY ESTOPPEL OR OTHERWISE TO ANY OTHER TI INTELLECTUAL PROPERTY RIGHT, AND NO LICENSE TO ANY TECHNOLOGY OR INTELLECTUAL PROPERTY RIGHT OF TI OR ANY THIRD PARTY IS GRANTED HEREIN, including but not limited to any patent right, copyright, mask work right, or other intellectual property right relating to any combination, machine, or process in which TI products or services are used. Information regarding or referencing third-party products or services does not constitute a license to use such products or services, or a warranty or endorsement thereof. Use of TI Resources may require a license from a third party under the patents or other intellectual property of the third party, or a license from TI under the patents or other intellectual property of TI.

TI RESOURCES ARE PROVIDED "AS IS" AND WITH ALL FAULTS. TI DISCLAIMS ALL OTHER WARRANTIES OR REPRESENTATIONS, EXPRESS OR IMPLIED, REGARDING TI RESOURCES OR USE THEREOF, INCLUDING BUT NOT LIMITED TO ACCURACY OR COMPLETENESS, TITLE, ANY EPIDEMIC FAILURE WARRANTY AND ANY IMPLIED WARRANTIES OF MERCHANTABILITY, FITNESS FOR A PARTICULAR PURPOSE, AND NON-INFRINGEMENT OF ANY THIRD PARTY INTELLECTUAL PROPERTY RIGHTS.

TI SHALL NOT BE LIABLE FOR AND SHALL NOT DEFEND OR INDEMNIFY YOU AGAINST ANY CLAIM, INCLUDING BUT NOT LIMITED TO ANY INFRINGEMENT CLAIM THAT RELATES TO OR IS BASED ON ANY COMBINATION OF PRODUCTS EVEN IF DESCRIBED IN TI RESOURCES OR OTHERWISE. IN NO EVENT SHALL TI BE LIABLE FOR ANY ACTUAL, DIRECT, SPECIAL, COLLATERAL, INDIRECT, PUNITIVE, INCIDENTAL, CONSEQUENTIAL OR EXEMPLARY DAMAGES IN CONNECTION WITH OR ARISING OUT OF TI RESOURCES OR USE THEREOF, AND REGARDLESS OF WHETHER TI HAS BEEN ADVISED OF THE POSSIBILITY OF SUCH DAMAGES.

You agree to fully indemnify TI and its representatives against any damages, costs, losses, and/or liabilities arising out of your non-compliance with the terms and provisions of this Notice.

This Notice applies to TI Resources. Additional terms apply to the use and purchase of certain types of materials, TI products and services. These include; without limitation, TI's standard terms for semiconductor products (<http://www.ti.com/sc/docs/stdterms.htm>), [evaluation modules](#), and [samples](http://www.ti.com/sc/docs/sampterm.htm) (<http://www.ti.com/sc/docs/sampterm.htm>).

Mailing Address: Texas Instruments, Post Office Box 655303, Dallas, Texas 75265  
Copyright © 2017, Texas Instruments Incorporated