

REVISIONS					
REV	DATE	DESCRIPTION	BY	CHK	APPV
H7	23NOV2022	REVIS PER ECR-22-154022	RK	MT	

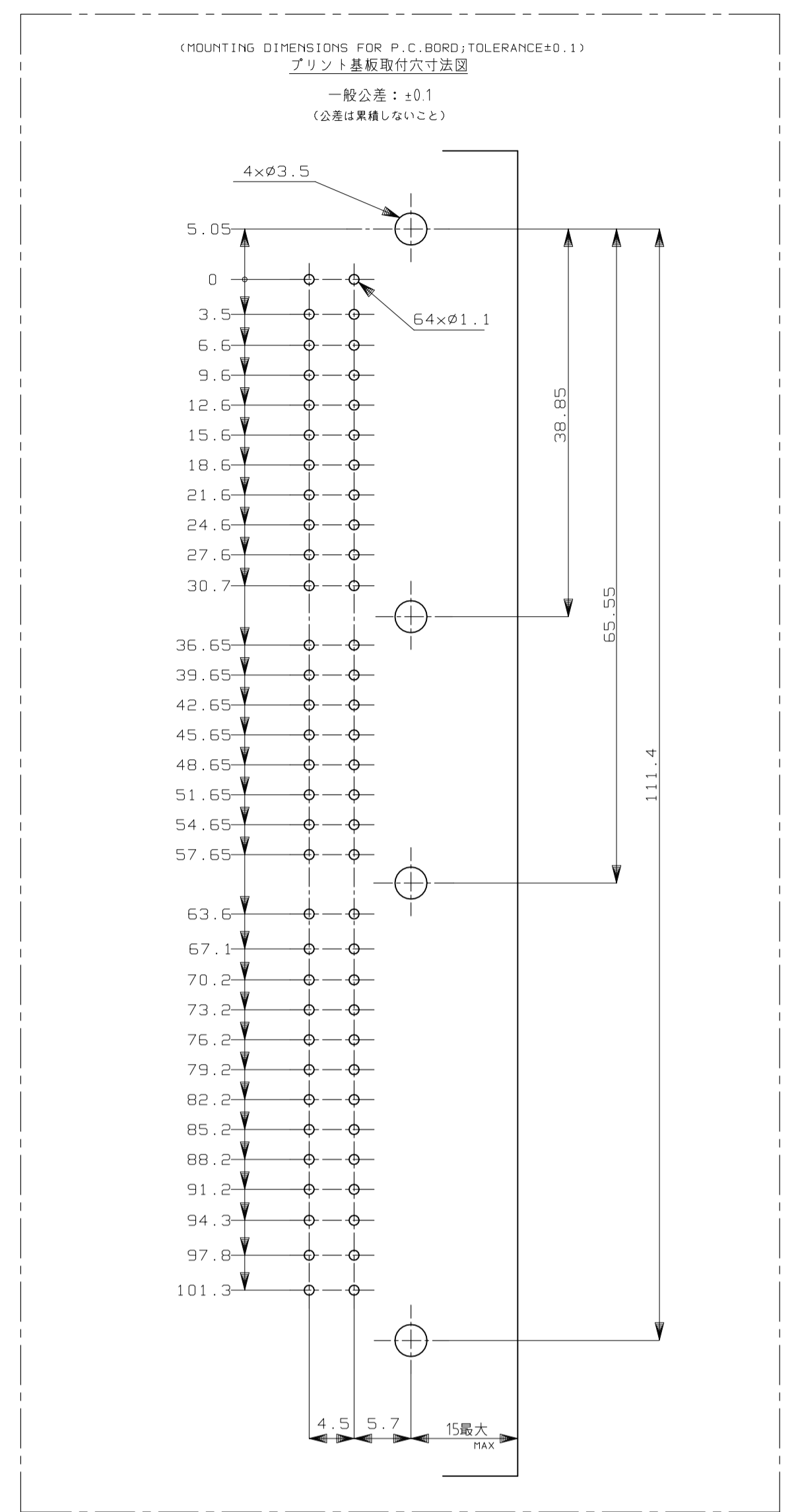

- △ [X] 面から2mmの範囲で測定
- 2. 嵌合相手ハウジング型 174516, 174515, 174514, 917992, 917989, 917981
- 3. 推奨取付ねじ: JIS B1115, B1112 タップねじ, なべ2種
呼び径3, 長さ6mm以下 (締付けトルク: 0.4N-m (4kg-cm) 以下)
- 4. 適用製品規格番号: 108-5280, 108-5342
- △ 回路番号:
- パワー回路 ① ~ ⑩
- シグナル回路 ⑪ ~ ⑥④

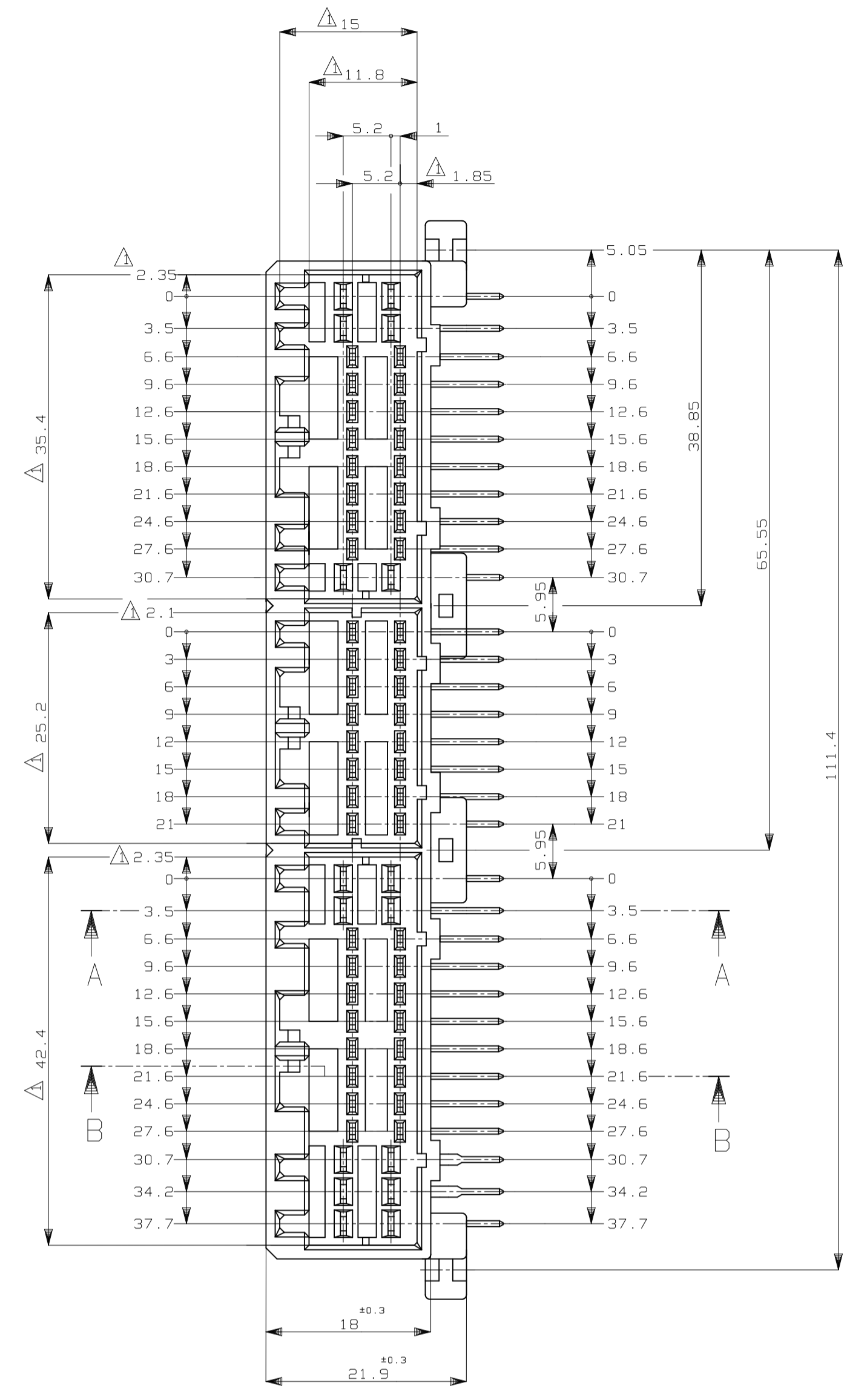
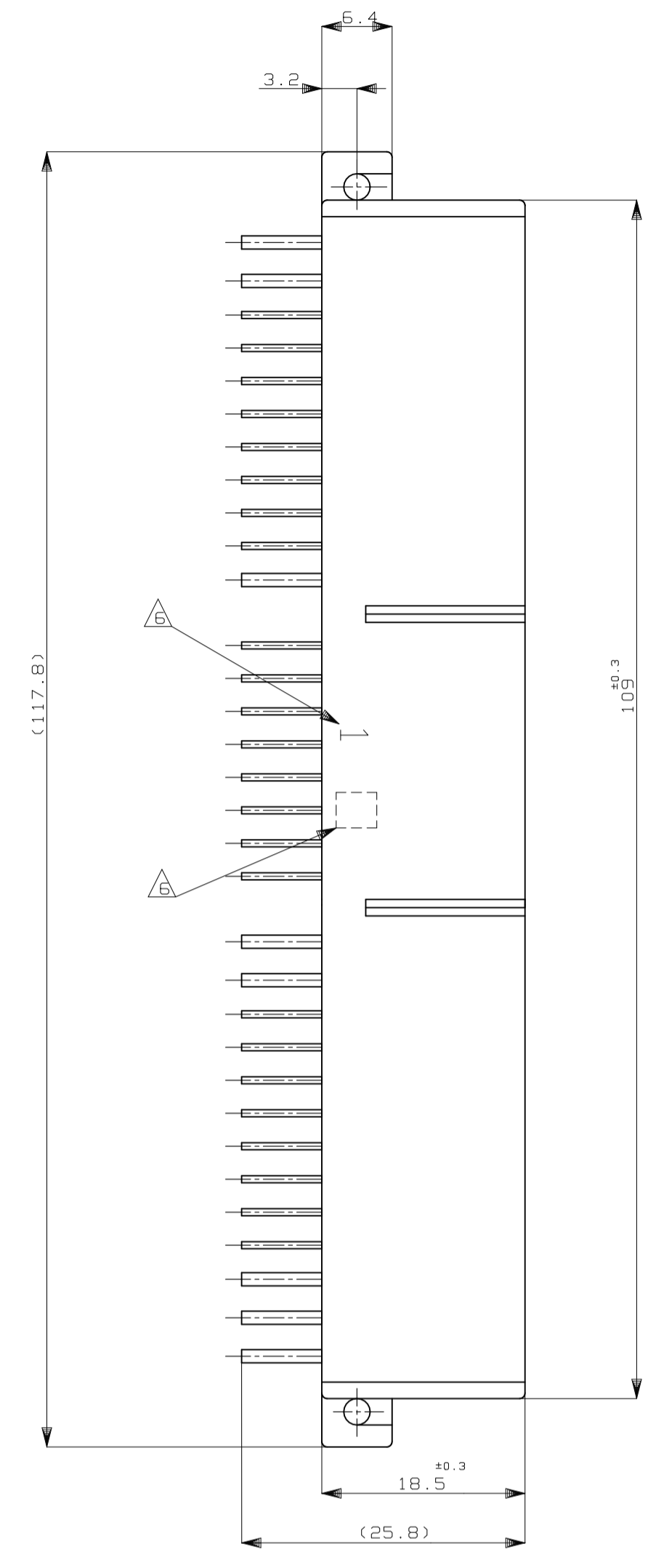
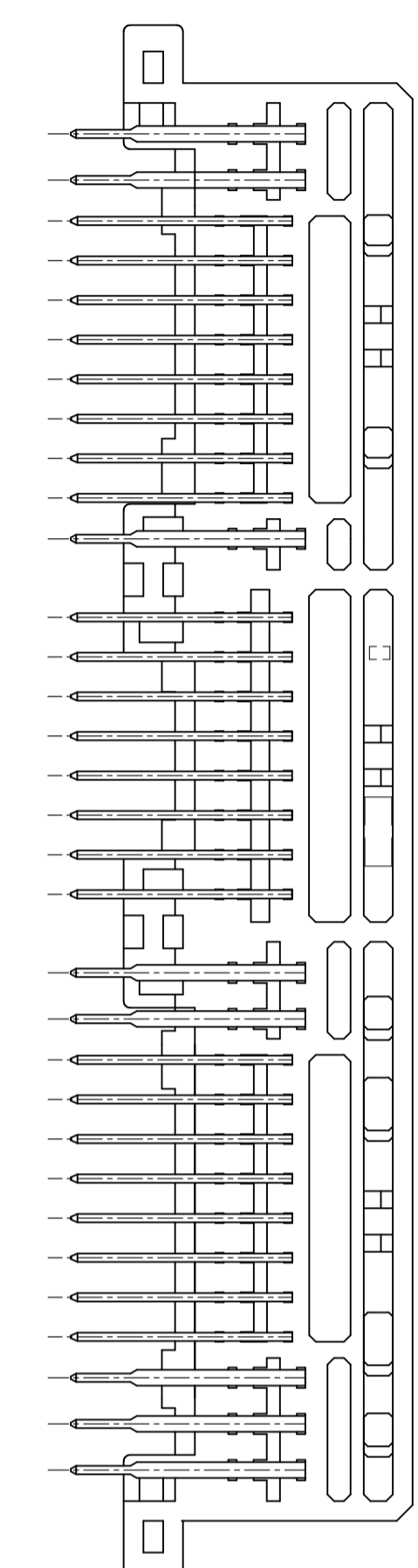
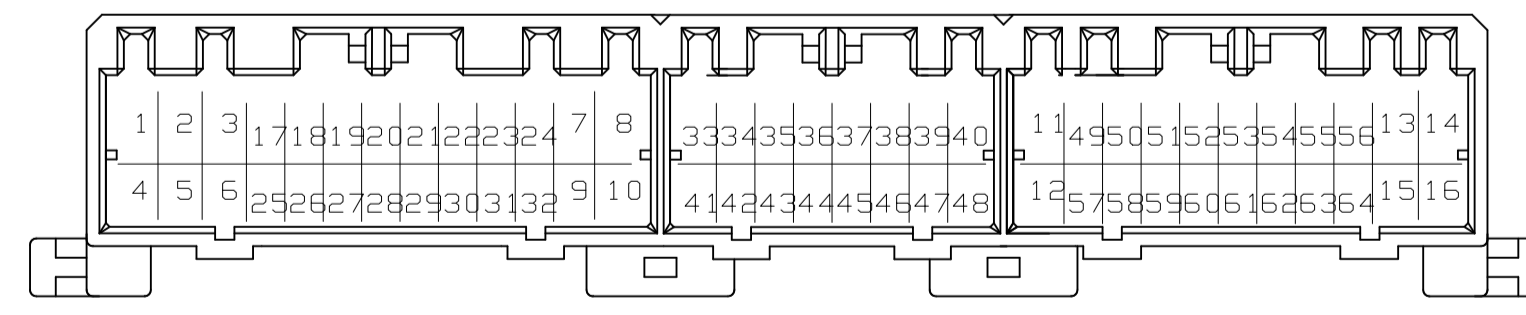

- △ 適用製品型番のプリフィックス及びIDマークをカラーホットマークにて表示
- 1. MUST BE KEPT BETWEEN [X] AND 2
- 2. THE MATING PLUG HSG PART NUMBER: 174516, 174515, 174514, 917992, 917989, 917981
- 3. RECOMMENDED MOUNTING SCREW: 3mm DIA, 6mm LENGTH (MAX.)
PAN HEAD, CLASS 2 TAPPING SCREW SPECIFIED IN JIS B1115, B1112
(TIGHTENING TORQUE: 0.4N-m (4kg-cm) MAX.)
- 4. APPLICABLE PRODUCT SPEC NO.: 108-5280, 108-5342
- △ CIRCUIT NUMBER
- POWER CIRCUIT NO. ① ~ ⑩
- SIGNAL CIRCUIT NO. ⑪ ~ ⑥④
- △ INDICATED PREFIX AND ID MARK OF PRODUCT P/N BY COLOR HOT MARK

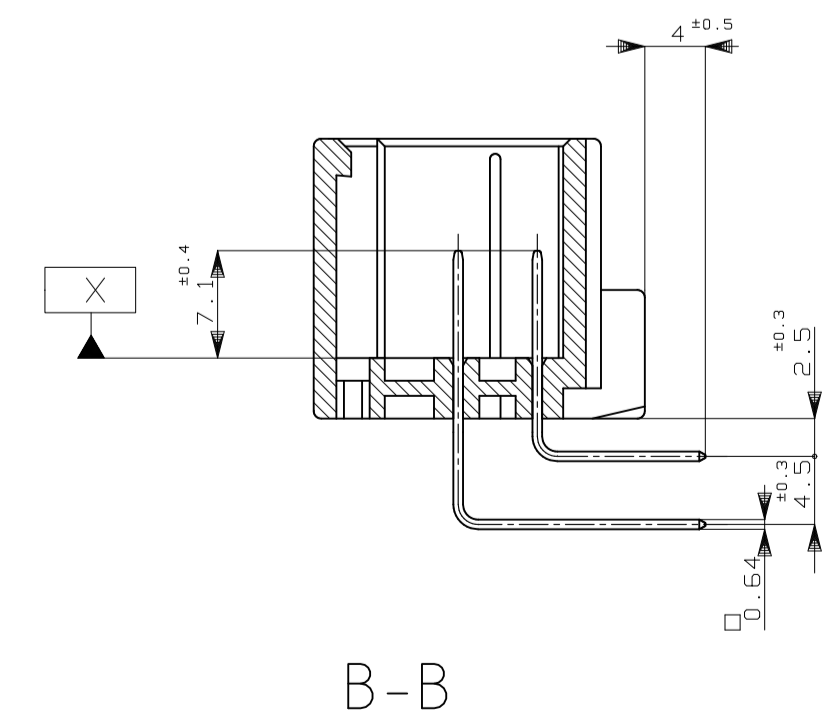
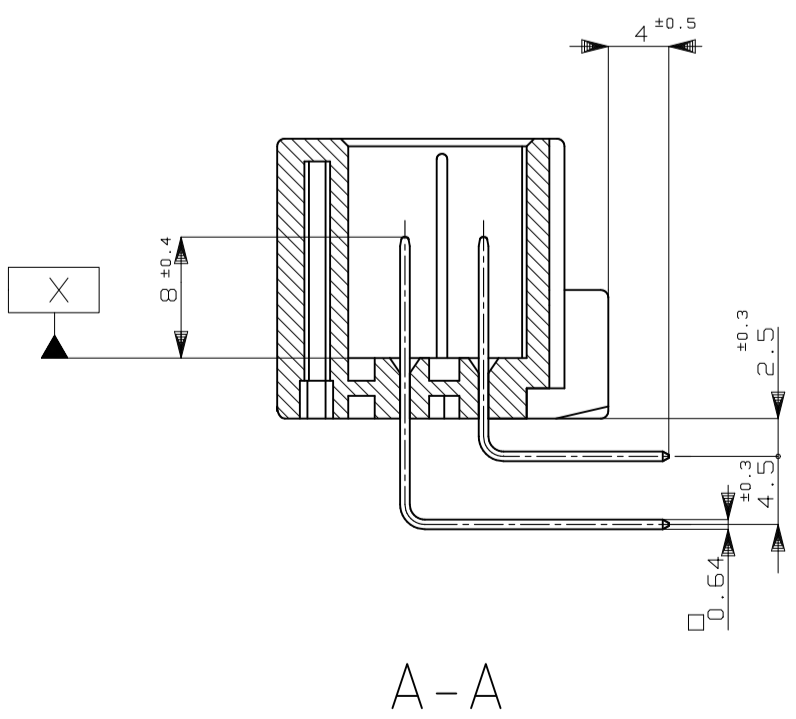

REV	DESCRIPTION	DATE	BY	CHK	APPV
OBSOLETE	59 SELECTIVE-TIN (MATTE) PRE-TIN x 56 SELECTIVE GOLD x 8				
OBSOLETE	51 SELECTIVE-TIN (MATTE) PRE-TIN x 56 SELECTIVE GOLD x 64	1~16			
OBSOLETE	52 SELECTIVE-TIN (MATTE) PRE-TIN x 16 SELECTIVE GOLD x 48	-			
OBSOLETE	59 SELECTIVE-TIN (MATTE) PRE-TIN x 56 SELECTIVE GOLD x 8				
OBSOLETE	56 SELECTIVE-TIN (MATTE) PRE-TIN x 52 SELECTIVE GOLD x 55	14, 16			
OBSOLETE	9 TIN-LEAD PRE-TIN x 56 SELECTIVE GOLD x 8				
OBSOLETE	9 TIN-LEAD PRE-TIN x 56 SELECTIVE GOLD x 8				
OBSOLETE	8 TIN-LEAD PRE-TIN x 52 SELECTIVE GOLD x 12	33, 34, 38~39, 40, 43, 50, 53~56			
OBSOLETE	7 TIN-LEAD PRE-TIN x 48 SELECTIVE GOLD x 16	-	33~40, 49~56		
OBSOLETE	6 TIN-LEAD PRE-TIN x 48 SELECTIVE GOLD x 9	14, 16			
OBSOLETE	5 TIN-LEAD PRE-TIN x 55 SELECTIVE GOLD x 24	-	17~24, 33~40, 49~56		
OBSOLETE	4 TIN-LEAD PRE-TIN x 40 SELECTIVE GOLD x 22	-	23, 24, 31~48, 52, 57		
OBSOLETE	3 TIN-LEAD PRE-TIN x 42 SELECTIVE GOLD x 52	7~10			
OBSOLETE	3 TIN-LEAD PRE-TIN x 12 SELECTIVE GOLD x 52	7~10			
OBSOLETE	2 TIN-LEAD PRE-TIN x 16 SELECTIVE GOLD x 48	-			
OBSOLETE	2 TIN-LEAD PRE-TIN x 16 SELECTIVE GOLD x 48				
OBSOLETE	2 TIN-LEAD PRE-TIN x 16 SELECTIVE GOLD x 48				
OBSOLETE	1 TIN-LEAD PRE-TIN x 64 SELECTIVE GOLD x 64	1~16			
OBSOLETE	1 TIN-LEAD PRE-TIN x 64 SELECTIVE GOLD x 64	1~16			
OBSOLETE	0 PRE-TIN x 64	-			
OBSOLETE	0 PRE-TIN x 64	-			

THIS DRAWING IS A CONTROLLED DOCUMENT.

DIN T. SHINOHARA 12FEB08
CHK K. BETSUJI 12FEB08
APPV K. BETSUJI 12FEB08

TE Connectivity

64 POSITION CAP HOUSING ASSEMBLY
040/070 SERIES HYBRID I/O CONNECTOR

SIZE: A1 CAGE CODE: 00779 DRAWING NO: 174518

WEIGHT: 29.9 g

CUSTOMER DRAWING

SCALE: 2:1 SHEET: 1 of 1 REV: H7