

APPROVAL SHEET

WQBD1005- 3216 Chip Bead Series AEC-Q200



*Contents in this sheet are subject to change without prior notice.

FEATURES

1. Monolithic inorganic material construction
2. Closed magnetic circuit avoids crosstalk
3. SMD Type & suitable for reflow and wave soldering
4. Available in various sizes
5. Excellent solderability and heat resistance
6. AEC-Q200 Qualified.

APPLICATIONS

Filtering between analog and digital circuitry, clock generation circuitry, I/O interconnects, isolation between RF noisy circuits and logic devices susceptible to functional degradation, power supply filtering to prevent conducted RF energy from corrupting the power generation circuitry. Sharp impedance characteristics can effectively minimize attenuation, high frequency EMI prevention of LCD monitor, PDA, Computers, Computer peripherals, Cellular Equipment, Digital TV, Digital Cameras, Audio/Visual Equipment, DVD, Wireless Communication Devices, MP3. Qualified based on AECQ200 for Automotive usage.

SHAPE and DIMENSION

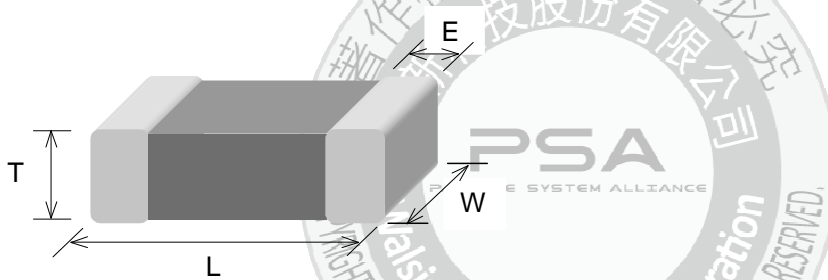

TYPE	1005 (EIA 0402)	1608 (EIA 0603)	2012 (EIA 0805)	3216 (EIA 1206)
L	1.00±0.10	1.60±0.15	2.00±0.20	3.20±0.20
W	0.50±0.10	0.80±0.15	1.25±0.20	1.60±0.20
T	0.50±0.10	0.80±0.15	0.90±0.20	1.10±0.20
E	0.25±0.10	0.30±0.20	0.50±0.30	0.50±0.30
Unit	mm			

Ordering Information

WQ	BD	1005	K2	U	300	T	P
Product Code	Serie	Dimensions	Series extension	Tolerance	Value	Packing Code	
Inductor AEC-Q200	Chip Bead.	1005 (0402) 1608 (0603) 2012 (0805) 3216 (1206)	Refer to characteristic	U: ±25%	300 =30 OHM 301 =300 OHM 102 =1000OHM	T = 7" Paper Tape P = 7" Plastic Tape	P= General L= Low DCR

PART NUMBER AND CHARACTERISTICS TABLE

WQBD1005-3216 series (AEC-Q200)

Walsin Part Number	Impedance (Ω) +/-25%	Test Frequency (MHz)	DC Resistance (Ω) max.	Rated Current (mA) max.
WQBD1005K2U700TP	70	100	0.15	600
WQBD1005K2U121TP	120	100	0.25	500
WQBD1005K2U241TP	240	100	0.35	300
WQBD1005K2U601TP	600	100	0.65	200
WQBD1005K2U102TP	1000	100	0.90	200
WQBD1005K2U182TP	1800	100	1.40	200
Walsin Part Number	Impedance (Ω) +/-25%	Test Frequency (MHz)	DC Resistance (Ω) max.	Rated Current (mA) max.
WQBD1608K2U800TP	80	100	0.10	600
WQBD1608K2U121TP	120	100	0.18	500
WQBD1608K2U221TP	220	100	0.25	500
WQBD1608K2U471TP	470	100	0.35	500
WQBD1608K2U601TP	600	100	0.38	500
WQBD1608K2U102TP	1000	100	0.50	400
WQBD1608K2U182TP	1800	100	1.50	50
WQBD1608K2U222TP	2200	100	1.50	50
WQBD1608K2U252TP	2500	100	1.50	50
Walsin Part Number	Impedance (Ω) +/-25%	Test Frequency (MHz)	DC Resistance (Ω) max.	Rated Current (mA) max.
WQBD2012K2U121TP	120	100	0.15	200
WQBD2012K2U151TP	150	100	0.15	200
WQBD2012K2U221TP	220	100	0.20	200
WQBD2012K2U601TP	600	100	0.30	200
WQBD2012K2U102TP	1000	100	0.45	200
Walsin Part Number	Impedance (Ω) +/-25%	Test Frequency (MHz)	DC Resistance (Ω) max.	Rated Current (mA) max.
WQBD3216K2U601PP	600	100	0.90	200
Test Level	250 mV			
Test Instruments	<ul style="list-style-type: none"> ●Agilent 4291B RF IMPEDANCE / MATERIAL ANALYZER ●Agilent 4338B MILLIOHMMETER ●Agilent 8720E S-PARAMETER NETWORK ANALYZER ●HP6632B SYSTEM DC POWER SUPPLY 			

GENERAL TECHNICAL DATA

1. Operating temperature range : - 55°C ~ +125°C
2. Storage Condition : Less than 40°C and 70% RH
3. Storage Time: 6 months Max.
4. Soldering method: Reflow

PART NUMBER AND CHARACTERISTICS TABLE

Walsin Part Number	Impedance (Ω) +/-25%	Test Frequency (MHz)	DC Resistance (Ω) max.	Rated Current (mA) max.
WQBD1005K2U601TL	600	100	0.6	300
Test Level	250 mV			
Test Instruments	<ul style="list-style-type: none"> •Agilent 4291B RF IMPEDANCE / MATERIAL ANALYZER •Agilent 4338B MILLIOHMMETER •Agilent 8720E S-PARAMETER NETWORK ANALYZER •HP6632B SYSTEM DC POWER SUPPLY 			

GENERAL TECHNICAL DATA

1. Operating temperature range : - 55°C ~ +125°C
2. Storage Condition : Less than 40°C and 70% RH
3. Storage Time: 6 months Max.
4. Soldering method: Reflow



TAPE AND REEL SPECIFICATIONS

PLASTIC CARRIER

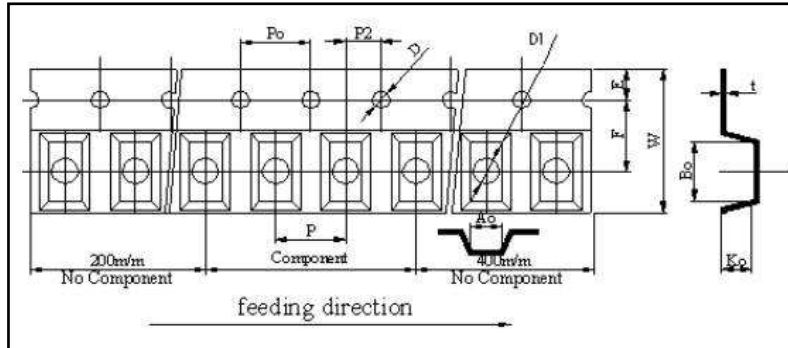

PAPER CARRIER

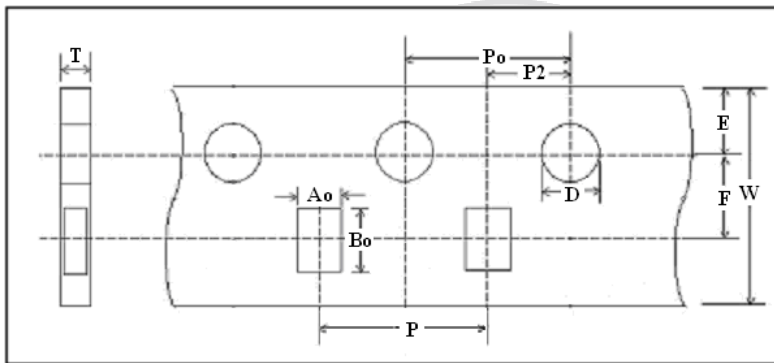

TAPING DIMENSIONS

Size	3216	2012	1608	1005
Symbol	PLASTIC	PAPER	PAPER	PAPER
W	7.90~8.30	8.00±0.10	8.00±0.10	8.00±0.10
P	4.00±0.10	4.00±0.10	4.00±0.10	2.00±0.05
E	1.75±0.10	1.75±0.10	1.75±0.10	1.75±0.05
F	3.50±0.05	3.50±0.10	3.50±0.10	3.50±0.05
D	1.55±0.05	1.56±0.10	1.56±0.10	1.55±0.05
D1	0.95~1.20	NA	NA	NA
Po	4.00±0.10	4.00±0.10	4.00±0.10	4.00±0.10
Po10	40.0±0.20	40.0±0.20	NA	NA
P2	2.00±0.05	2.00±0.10	2.00±0.10	2.00±0.05
Ao	1.85±0.10	1.50±0.05	1.05±0.05	0.62±0.03
Bo	3.43±0.10	2.30±0.05	1.85±0.05	1.12±0.03
Ko(T)	1.22±0.10	0.95±0.05	0.95±0.05	0.60±0.03
t	0.25±0.10	NA	NA	NA

Unit: mm

REEL DIMENSIONS

Unit: mm

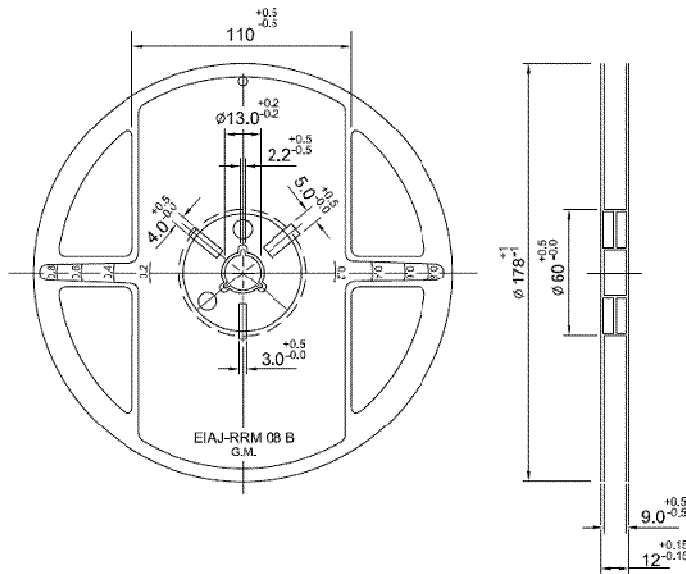

7" Reel Packaging Quantity				
PART SIZE (EIA SIZE)	1005 (0402)	1608 (0603)	2012 (0805)	3216 (1206)
Qty.(pcs)	10,000	4,000	4,000	3,000
BOX	5 reels / inner box			

RECOMMENDED SOLDERING CONDITIONS

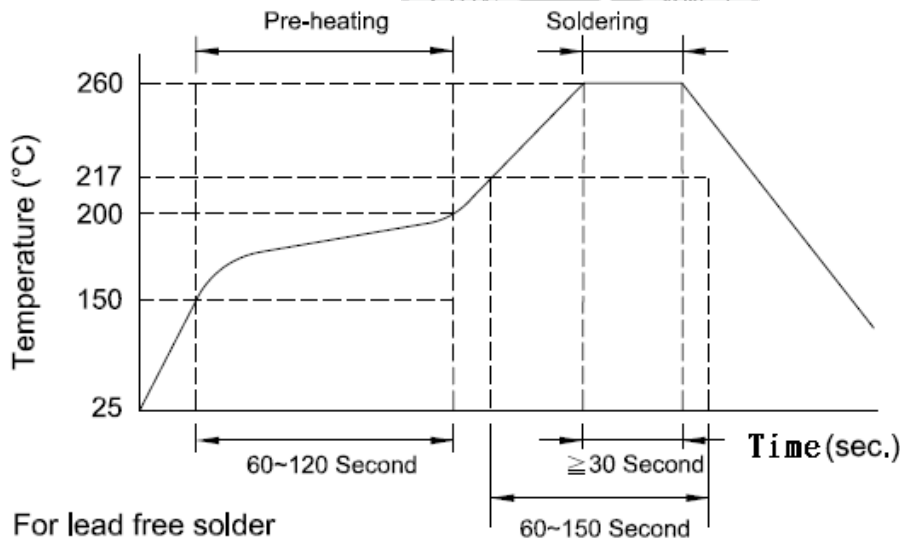

Impedance Frequency Characteristic (Typical)

WQBD1005K2U700TP

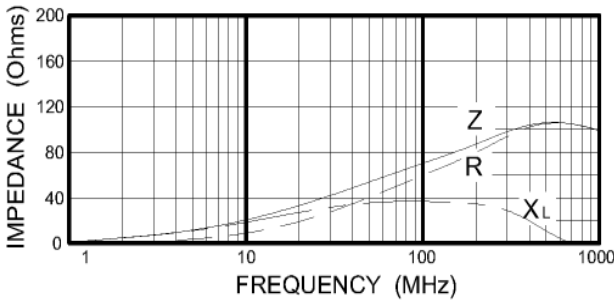

WQBD1005K2U121TP

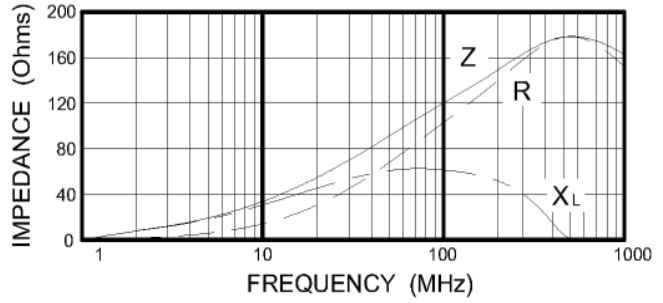

WQBD1005K2U241TP

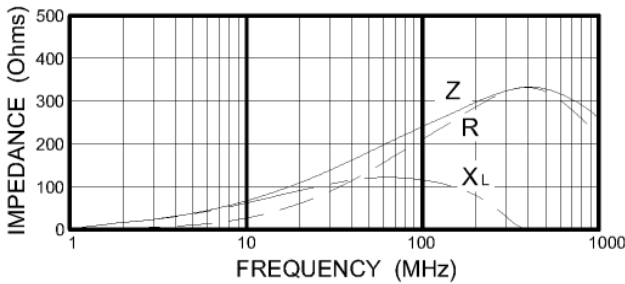

WQBD1005K2U601TP

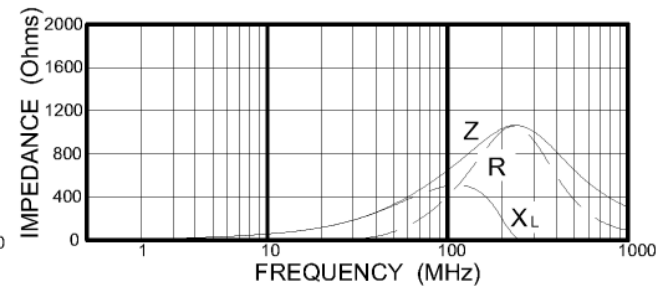

WQBD1005K2U102TP

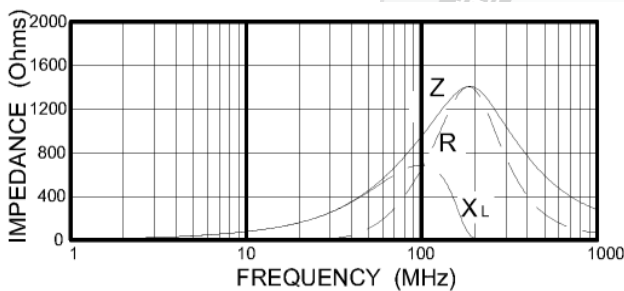

WQBD1005K2U182TP

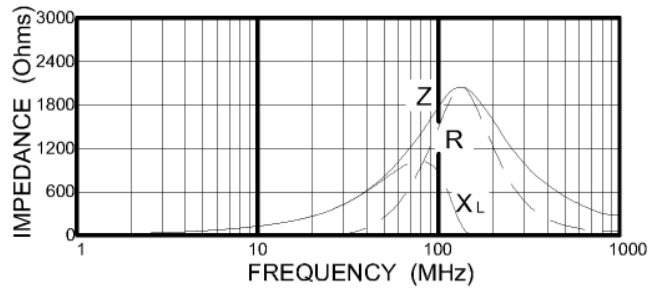

WQBD1608K2U800TP

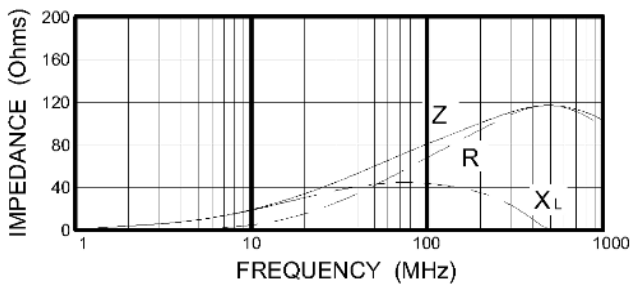

WQBD1608K2U121TP

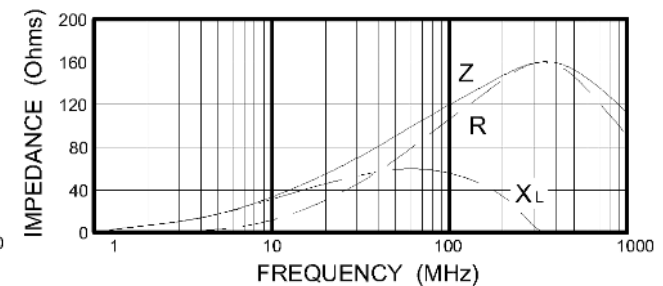

Impedance Frequency Characteristic (Typical)

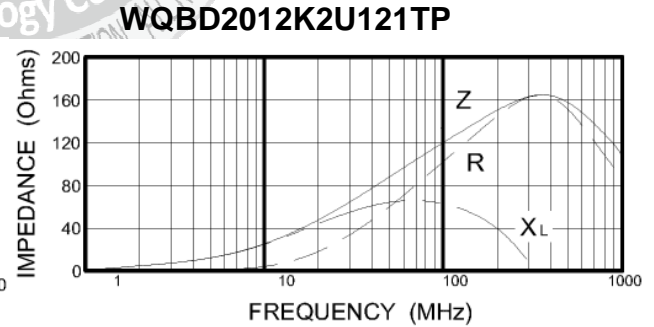
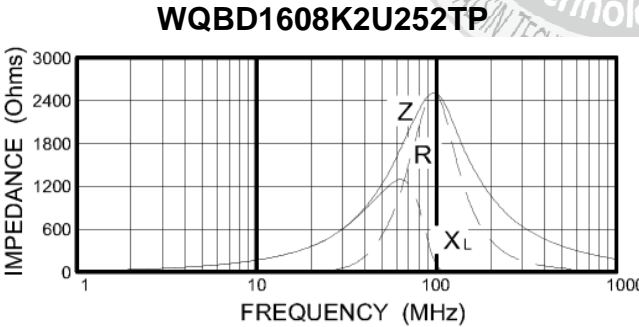
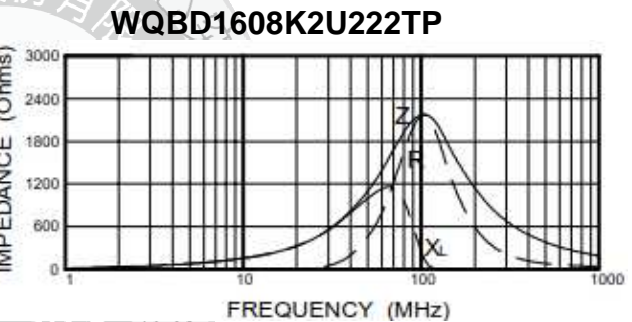
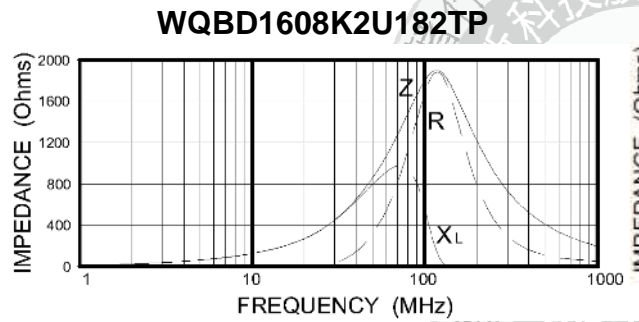
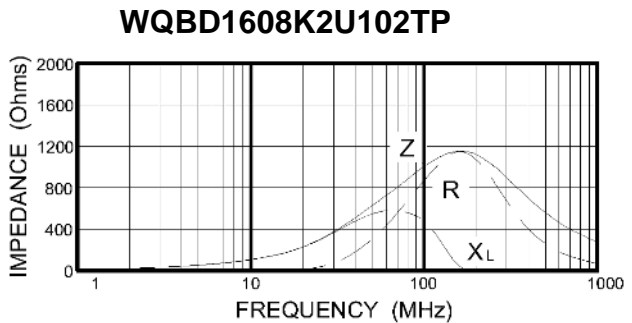
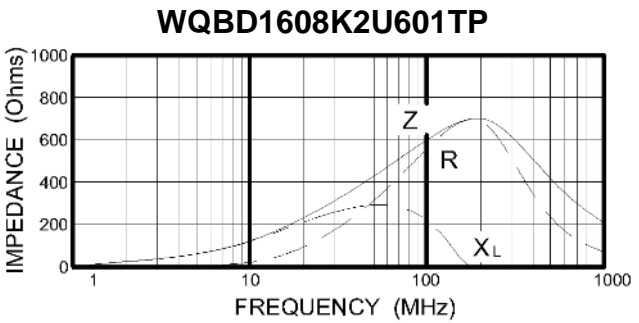
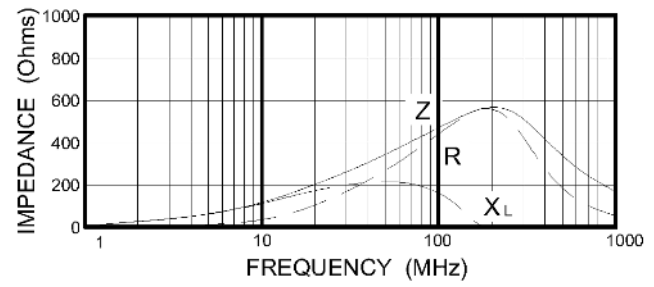
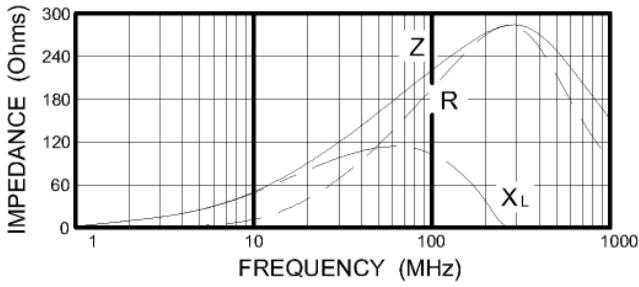

Impedance Frequency Characteristic (Typical) WQBD2012K2U151TP

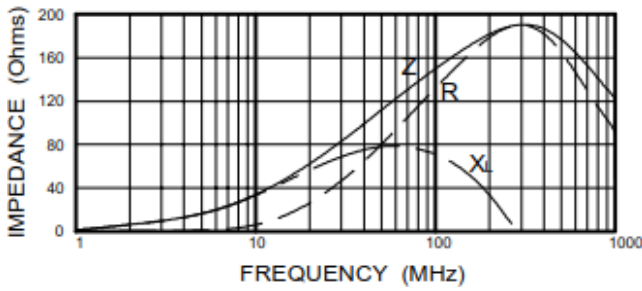

WQBD2012K2U221TP

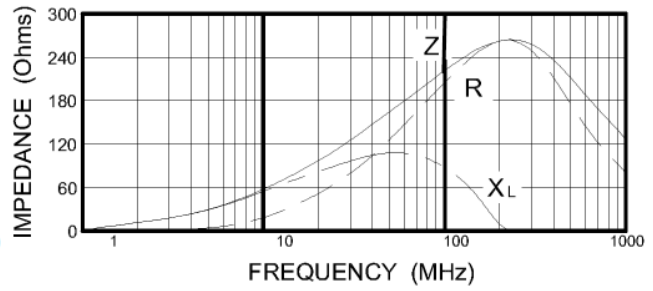

WQBD2012K2U601TP

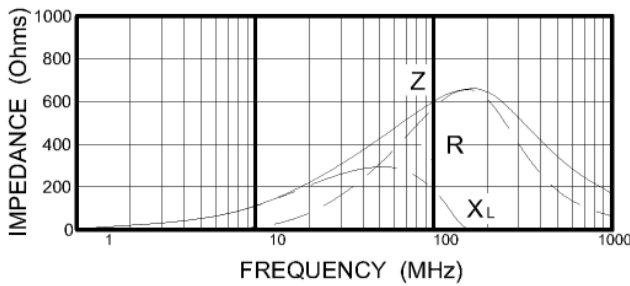

WQBD2012K2U102TP

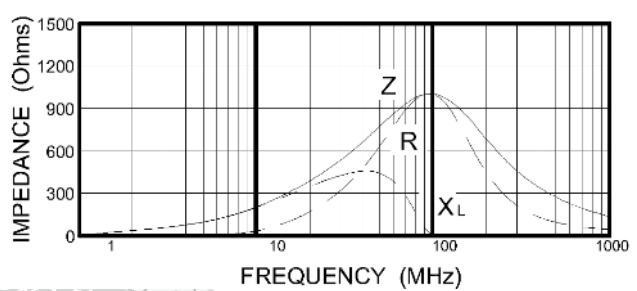

WQBD3216K2U601PP

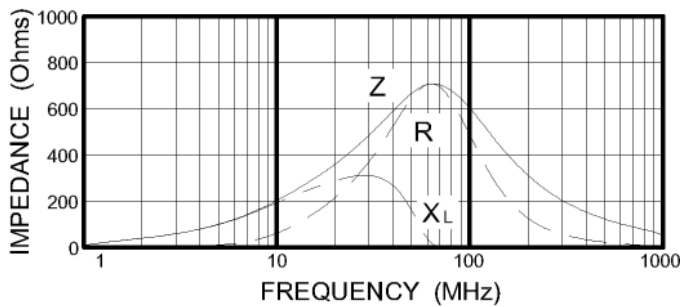

Impedance Frequency Characteristic (Typical)

WQBD1005K2U601PL

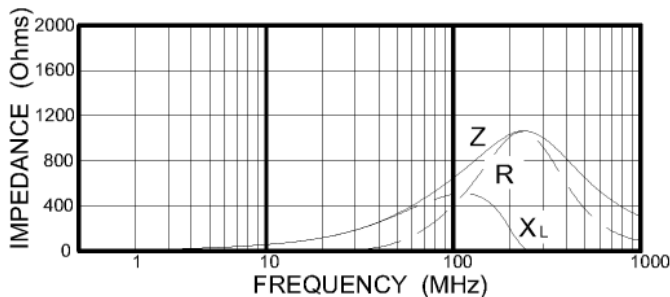

RELIABILITY AND TEST CONDITION

Test item	Test condition	Criteria
High Temperature Exposure	1. Temperature : $125^{\circ}\text{C} \pm 5^{\circ}\text{C}$ 2. Test time : 1000 hrs Measurement: at ambient temperature 24 hours after test completion	1. No mechanical damage 2. Impedance value should be within $\pm 30\%$ of the initial value
Temperature Cycle	1. Temperature : $-55 \sim +125^{\circ}\text{C}$ 2. Cycle : 1000 cycles 3. Dwell time : 30minutes Measurement : at ambient temperature 24 hours after test completion	1. No mechanical damage 2. Impedance value should be within $\pm 30\%$ of the initial value
Biased Humidity	1. Temperature : $85^{\circ}\text{C} \pm 2^{\circ}\text{C}$ 2. Humidity : 85 % RH 3. Test time : 1000 hours 4. Apply current : full rated current Measurement: at ambient temperature 24 hours after test completion	1. No mechanical damage 2. Impedance value should be within $\pm 30\%$ of the initial value
Operational Life	1. Temperature : $125^{\circ}\text{C} \pm 5^{\circ}\text{C}$ 2. Test time : 1000 hours 3. Apply current : full rated current Measurement : at ambient temperature 24 hours after test completion	1. No mechanical damage 2. Impedance value should be within $\pm 30\%$ of the initial value
Mechanical Shock	Condition F:1500g's/0.5ms/Half sine	1. No mechanical damage 2. Impedance value should be within $\pm 30\%$ of the initial value
Vibration Test	5g's for 20 minutes,12cycles each of 3 orientations Test from 10-2000Hz.,12cycles each of 3 orientations	1. No mechanical damage 2. Impedance value should be within $\pm 30\%$ of the initial value
Resistance to Solder Heat	1. Solder temperature : $260 \pm 5^{\circ}\text{C}$ 2. Flux : Rosin 3. DIP time : 10 ± 1 sec	1. More than 95 % of terminal electrode should be covered with new solder 2. No mechanical damage 3. Impedance value should be within $\pm 30\%$ of the initial value

Test item	Test condition	Criteria												
ESD	Classification Levels 1C 1000 V (DC) to < 2000 V (DC)	1. No mechanical damage 2. Impedance value should be within $\pm 30\%$ of the initial value												
Solderability Test	1. Solder temperature : $235 \pm 5^\circ\text{C}$ 2. Flux : Rosin 3. DIP time : 5 ± 1 sec	1. More than 95 % of terminal electrode should be covered with new solder 2. No mechanical damage												
Board Flex	Epoxy-PCB(1.6mm) Deflection 2mm(min) 60s minimum holding time	No mechanical damage.												
Terminal Strength	<table border="1"> <thead> <tr> <th>Size</th> <th>Apply Force(F)</th> <th>Test Time</th> </tr> </thead> <tbody> <tr> <td>1005</td> <td>5N</td> <td>10 ± 1 sec</td> </tr> <tr> <td>1608</td> <td>10 N</td> <td>10 ± 1 sec</td> </tr> <tr> <td>≥ 2012</td> <td>17.7 N</td> <td>60 ± 1 sec</td> </tr> </tbody> </table>	Size	Apply Force(F)	Test Time	1005	5N	10 ± 1 sec	1608	10 N	10 ± 1 sec	≥ 2012	17.7 N	60 ± 1 sec	No mechanical damage
Size	Apply Force(F)	Test Time												
1005	5N	10 ± 1 sec												
1608	10 N	10 ± 1 sec												
≥ 2012	17.7 N	60 ± 1 sec												

LAND PATTERNS FOR REFLOW SOLDERING

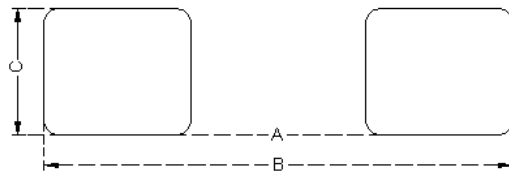

SOLDER LAND INFORMATION

Unit: mm (inches)

Size	A	B	C
1005	0.4 (0.016)	1.2 ~ 1.4 (0.047 ~ 0.055)	0.5 (0.020)
1608	0.7 (0.028)	1.8 ~ 2.0 (0.071 ~ 0.079)	0.7 (0.028)
2012	1.2 (0.047)	3.0 ~ 4.0 (0.118 ~ 0.157)	1.0 (0.039)
3216	2.0 (0.079)	4.2 ~ 5.2 (0.165 ~ 0.205)	1.2 (0.047)