

## P-Channel Enhancement Mode Power MOSFET

### Description

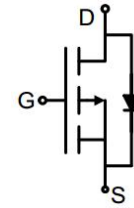
The G18P03D3 uses advanced trench technology to provide excellent  $R_{DS(ON)}$ , low gate charge. It can be used in a wide variety of applications.

### General Features

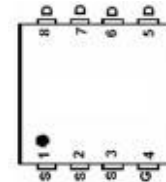
- $V_{DS}$  -30V
- $I_D$  (at  $V_{GS} = -10V$ ) -50A
- $R_{DS(ON)}$  (at  $V_{GS} = -10V$ ) < 10m $\Omega$
- $R_{DS(ON)}$  (at  $V_{GS} = -4.5V$ ) < 15m $\Omega$
- 100% Avalanche Tested
- RoHS Compliant

### Application

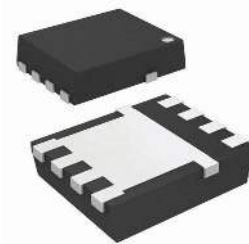
- Power switch
- DC/DC converters



Schematic diagram



pin assignment



DFN3X3-8L

### Ordering Information

Device	Package	Marking	Packaging
G18P03D3	DFN3x3-8L	G18P03	5000pcs/Reel

### Absolute Maximum Ratings $T_C = 25^\circ\text{C}$ , unless otherwise noted

Parameter	Symbol	Value	Unit
Drain-Source Voltage	$V_{DS}$	-30	V
Continuous Drain Current	$I_D$	-50	A
Pulsed Drain Current (note1)	$I_{DM}$	-200	A
Gate-Source Voltage	$V_{GS}$	$\pm 20$	V
Power Dissipation	$P_D$	60	W
Operating Junction and Storage Temperature Range	$T_J, T_{stg}$	-55 To 150	$^\circ\text{C}$

### Thermal Resistance

Parameter	Symbol	Value	Unit
Thermal Resistance, Junction-to-Ambient	$R_{thJA}$	80	$^\circ\text{C/W}$
Maximum Junction-to-Case	$R_{thJC}$	2.08	$^\circ\text{C/W}$

Specifications $T_J = 25^\circ\text{C}$ , unless otherwise noted						
Parameter	Symbol	Test Conditions	Value			Unit
			Min.	Typ.	Max.	
<b>Static Parameters</b>						
Drain-Source Breakdown Voltage	$V_{(BR)DSS}$	$V_{GS} = 0V, I_D = -250\mu A$	-30	--	--	V
Zero Gate Voltage Drain Current	$I_{DSS}$	$V_{DS} = -30V, V_{GS} = 0V$	--	--	-1	$\mu A$
Gate-Source Leakage	$I_{GSS}$	$V_{GS} = \pm 20V$	--	--	$\pm 100$	nA
Gate-Source Threshold Voltage	$V_{GS(th)}$	$V_{DS} = V_{GS}, I_D = -250\mu A$	-1	-1.5	-2.5	V
Drain-Source On-Resistance	$R_{DS(on)}$	$V_{GS} = -10V, I_D = -10A$	--	7.5	10	m $\Omega$
		$V_{GS} = -4.5V, I_D = -8A$	--	11	15	
Forward Transconductance	$g_{FS}$	$V_{DS} = -5V, I_D = -10A$	--	22	--	S
<b>Dynamic Parameters</b>						
Input Capacitance	$C_{iss}$	$V_{GS} = 0V,$ $V_{DS} = -15V,$ $f = 1.0MHz$	--	3074	--	pF
Output Capacitance	$C_{oss}$		--	518	--	
Reverse Transfer Capacitance	$C_{rss}$		--	455	--	
Total Gate Charge	$Q_g$	$V_{DD} = -15V,$ $I_D = -10A,$ $V_{GS} = -10V$	--	45	--	nC
Gate-Source Charge	$Q_{gs}$		--	6	--	
Gate-Drain Charge	$Q_{gd}$		--	13	--	
Turn-on Delay Time	$t_{d(on)}$	$V_{DD} = -15V,$ $I_D = -10A,$ $R_G = 3\Omega$	--	11	--	ns
Turn-on Rise Time	$t_r$		--	9	--	
Turn-off Delay Time	$t_{d(off)}$		--	24	--	
Turn-off Fall Time	$t_f$		--	12	--	
<b>Drain-Source Body Diode Characteristics</b>						
Continuous Body Diode Current	$I_S$	$T_C = 25^\circ\text{C}$	--	--	-50	A
Body Diode Voltage	$V_{SD}$	$T_J = 25^\circ\text{C}, I_{SD} = -10A, V_{GS} = 0V$	--	--	-1.2	V
Reverse Recovery Charge	$Q_{rr}$	$I_F = -10A, V_{GS} = 0V$ $di/dt = -100A/\mu s$	--	8	--	nC
Reverse Recovery Time	$T_{rr}$		--	15	--	ns

### Notes

1. Repetitive Rating: Pulse width limited by maximum junction temperature
2. Identical low side and high side switch with identical  $R_G$

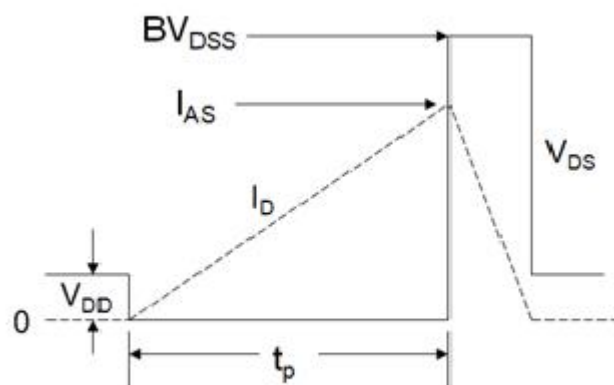
### Gate Charge Test Circuit



### Switch Time Test Circuit

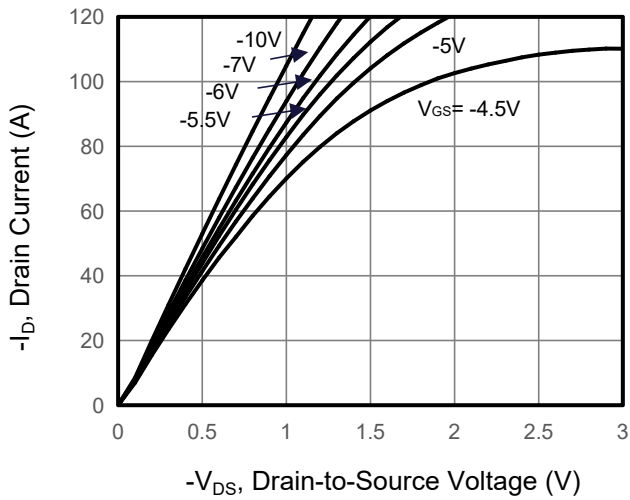


### EAS Test Circuit

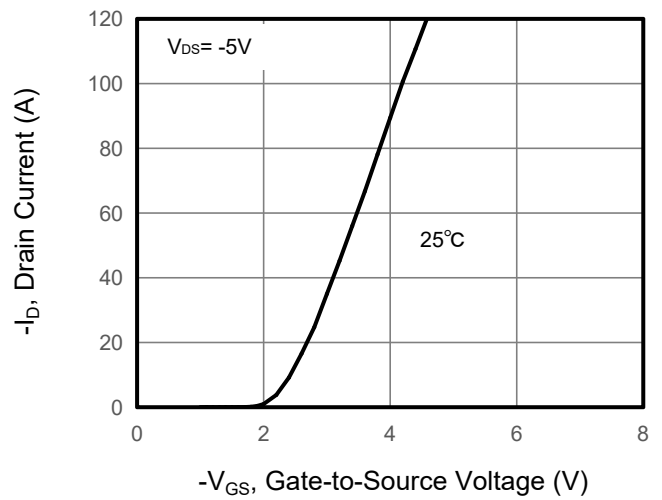


Typical Characteristics  $T_J = 25^\circ\text{C}$ , unless otherwise noted

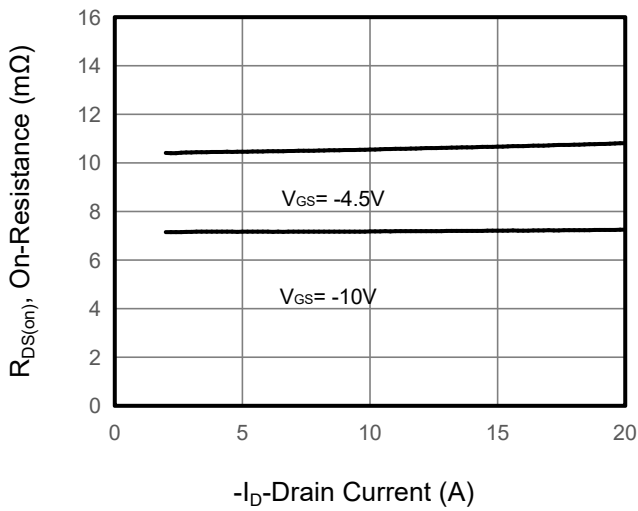
**Figure 1. Output Characteristics**



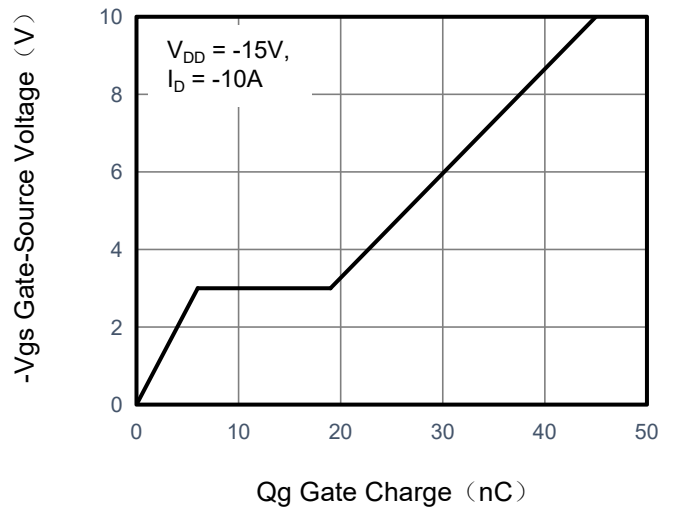
**Figure 2. Transfer Characteristics**



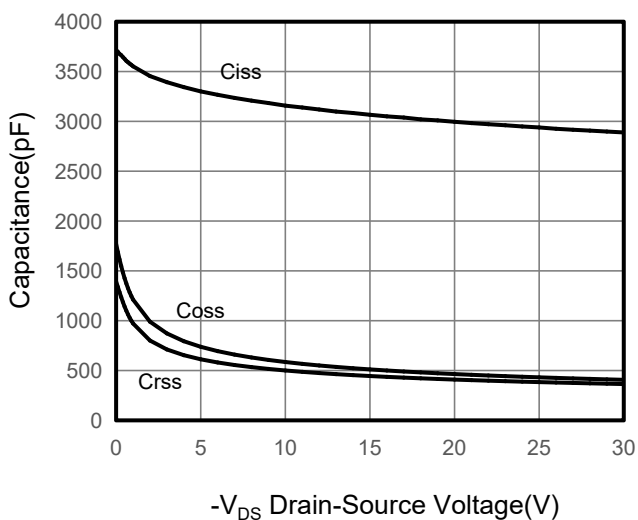
**Figure 3. Drain Source On Resistance**



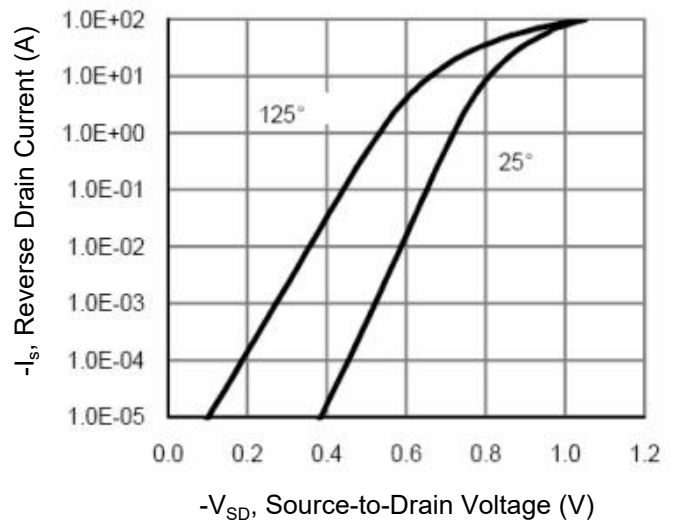
**Figure 4. Gate Charge**



**Figure 5. Capacitance**

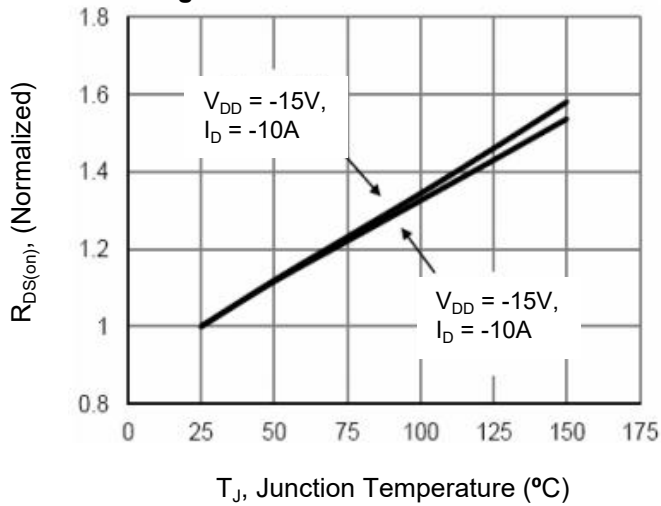


**Figure 6. Source-Drain Diode Forward**

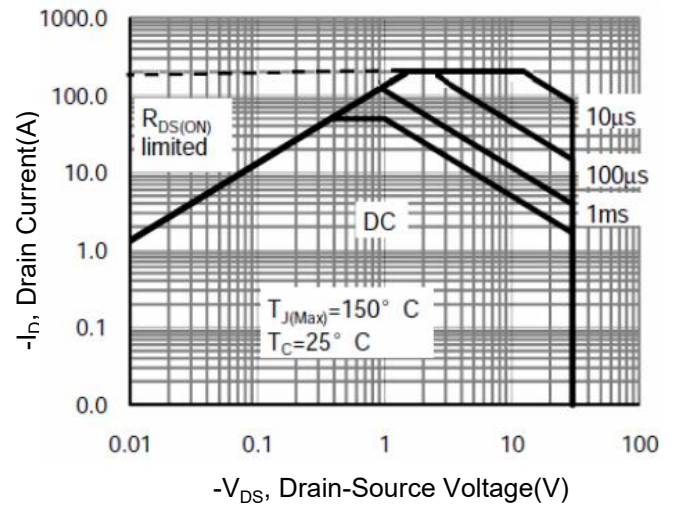


## Typical Characteristics $T_J = 25^\circ\text{C}$ , unless otherwise noted

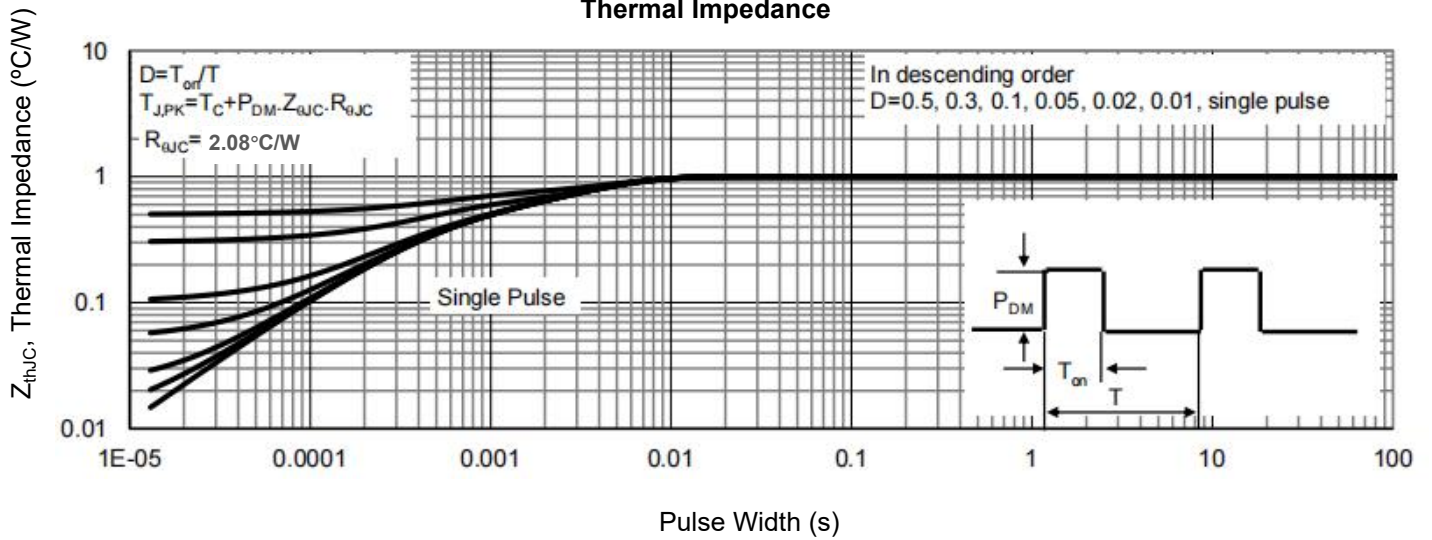
**Figure 7. Drain-Source On-Resistance**



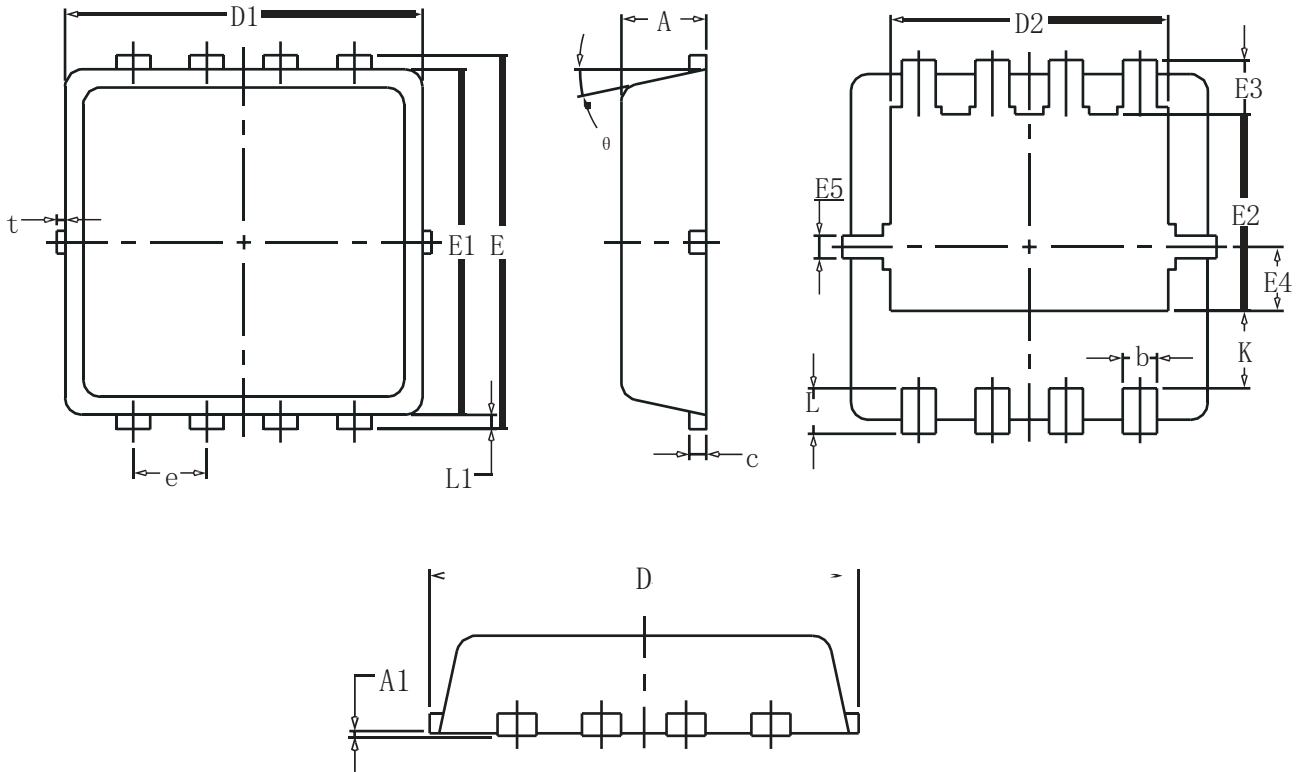
**Figure 10. Safe Operation Area**



**Figure 9. Normalized Maximum Transient Thermal Impedance**



## DFN3x3-8L Package Information



SYMBOL	COMMON		
	MM		
	MIN	NOM	MAX
A	0.70	0.75	0.85
A1	-	-	0.05
b	0.20	0.30	0.40
c	0.10	0.152	0.25
D	3.15	3.30	3.45
D1	3.00	3.15	3.25
D2	2.29	2.45	2.65
E	3.15	3.30	3.45
E1	2.90	3.05	3.20
E2	1.54	1.74	1.94
E3	0.28	0.48	0.65
E4	0.37	0.57	0.77
E5	0.10	0.20	0.30
e	0.60	0.65	0.70
K	0.59	0.69	0.89
L	0.30	0.40	0.50
L1	0.06	0.125	0.20
t	0	0.075	0.13
$\theta$	10°	12°	14°