

FEATURES

- Very wide bandwidth to 24 GHz
- Time delay range: 70 ps typical
- Single-ended or differential operation
- Adjustable differential output amplitude with 780 mV p-p typical at 10 GHz
- Delay control modulation bandwidth: 1.6 GHz typical
- Single supply: 3.3 V
- 24-terminal ceramic, leadless chip carrier (LCC)

APPLICATIONS

- Synchronization of clock and data
- Transponder design
- Serial data transmissions up to 32 Gbps
- Broadband test and measurement
- RF ATE applications

GENERAL DESCRIPTION

The **HMC911** is a broadband time delay with 62 ps to 75 ps continuously adjustable delay range to 24 GHz. The delay control is linearly monotonic with respect to the differential delay control voltage (V_{DCP} and V_{DCN}), and the control input has a modulation bandwidth of 1.6 Hz. The **HMC911** provides a differential output voltage with constant amplitude for single-ended or differential input voltages above the input sensitivity level, and the output voltage swing can be adjusted using the V_{AC} control pin.

FUNCTIONAL BLOCK DIAGRAM

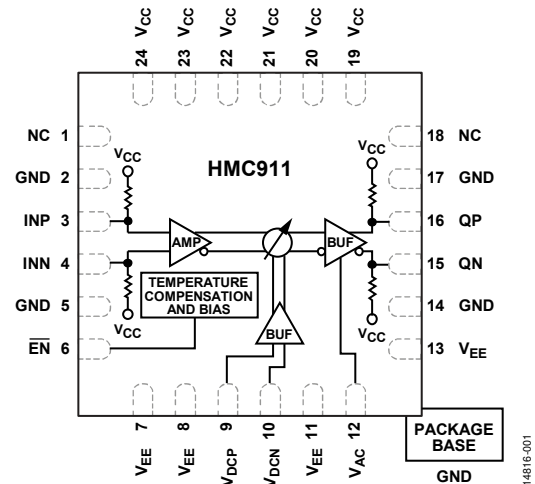

Figure 1.

The **HMC911** features internal temperature compensation and bias circuitry to minimize delay variations with temperature. All RF inputs and outputs of the **HMC911** are internally terminated with $50\ \Omega$ to V_{CC} and can be ac-coupled or dc-coupled. Output pins connect directly to a $50\ \Omega$ to V_{CC} terminated system. However, use dc blocking capacitors if the terminated system input is $50\ \Omega$ to a dc voltage other than V_{CC} .

The **HMC911** is available in a RoHS-compliant, 24-terminal, ceramic, leadless chip carrier.

TABLE OF CONTENTS

Features	1	Pin Configuration and Function Descriptions.....	5
Applications.....	1	Interface Schematics	6
Functional Block Diagram	1	Typical Performance Characteristics	7
General Description	1	Applications Information	11
Revision History	2	Evaluation Printed Circuit Board (PCB).....	11
Specifications.....	3	Typical Application Circuit	12
Absolute Maximum Ratings.....	4	Outline Dimensions	13
ESD Caution.....	4	Ordering Guide	13

REVISION HISTORY

10/2016—Rev. v02.0614 to Rev. B

Updated Format.....	Universal	Changes to Figure 13 Caption	7
Changes to Product Title, Features Section, and General Description Section.....	1	Changes to Figure 17 Caption and Figure 20 Caption	8
Changes to Table 1.....	3	Changes to Figure 31 Caption	10
Changes to Table 2.....	4	Changes to Table 4.....	11
Changes to Table 3.....	5	Changes to Typical Application Circuit Section	12
Changes to Figure 4 and Figure 6.....	6	Updated Outline Dimensions.....	13
		Changes to Ordering Guide.....	13

SPECIFICATIONS

$T_A = 25^\circ\text{C}$, $V_{CC} = 3.3\text{ V}$, $V_{AC} = 2.6\text{ V}$, $V_{EE} = \text{GND} = 0\text{ V}$, unless otherwise noted.

Table 1.

Parameter	Min	Typ	Max	Unit	Test Conditions/Comments
POWER SUPPLY					
Voltage	3.13	3.3	3.47	V	$\pm 5\%$ tolerance
Current	460		530	mA	
TIME DELAY RANGE					
10 GHz	62	70	71	ps	$V_{DCP} = 3.9\text{ V}$, $V_{DCN} = 3.3\text{ V}$
18 GHz	64	70	73	ps	
22 GHz	66	70	75	ps	
TIME DELAY SENSITIVITY					
Voltage		116		ps/V	$V_{DCP} = V_{DCN} = 3.3\text{ V}$ at 18 GHz
Temperature		0.04		ps/ $^\circ\text{C}$	
PHASE SHIFT RANGE					
10 GHz	210		250	Degrees	$V_{DCP} = 3.9\text{ V}$, $V_{DCN} = 3.3\text{ V}$
18 GHz	400		475	Degrees	
22 GHz	515		595	Degrees	
MAXIMUM DATA RATE	32			Gbps	
MAXIMUM CLOCK FREQUENCY	24			GHz	
DELAY CONTROL					
Modulation Bandwidth		1.6		GHz	
Voltage (V_{DCP} and V_{DCN})	$V_{CC} - 0.6$		$V_{CC} + 0.6$	V	
INPUT VOLTAGE					
Low (V_{IL})	$V_{CC} - 500$	$V_{CC} - 200$	$V_{CC} - 25$	mV	
High (V_{IH})	$V_{CC} + 25$	$V_{CC} + 200$	$V_{CC} + 500$	mV	
INPUT AMPLITUDE, PEAK TO PEAK					
Single Ended	50		1000	mV p-p	
Differential	100		2000	mV p-p	
OUTPUT AMPLITUDE					
10 GHz	370	390	640	mV p-p	$V_{AC} = 2.6\text{ V}$ Single-ended
	740	780	1280	mV p-p	
18 GHz	350	375	640	mV p-p	Single-ended
	700	750	1280	mV p-p	
22 GHz	340	350	640	mV p-p	Single-ended
	680	700	1280	mV p-p	
CONTROL VOLTAGE (V_{AC})	1.7	2.6	2.7	V	
HARMONIC SUPPRESSION ($f_{IN} - 2f_{IN}$) ^{1,2}					
10 GHz	21		32	dBc	$V_{DCP} = V_{DCN} = 3.3\text{ V}$
20 GHz	19		30	dBc	
RETURN LOSS					
Input		9		dB	Frequency < 24 GHz
Output		10		dB	
RMS JITTER		0.3		ps, p-p	32 Gbps, 10101 ... data
TIME ³					
Rise (t_R)		15		ps	
Fall (t_F)		14		ps	
PROPAGATION DELAY		480		ps	$V_{DCP} = 2.7\text{ V}$, $V_{DCN} = 3.3\text{ V}$ (relative to zero time delay)

¹ Harmonic suppression measurements were taken for single-ended inputs and outputs.

² f_{IN} is the fundamental frequency.

³ $V_{INPUT} =$ differential 400 mV p-p, and $f_{DATA} = 22.5\text{ Gbps}$, and pseudorandom bit sequences (PRBS) $2^{33} - 1$

ABSOLUTE MAXIMUM RATINGS

Table 2.

Parameter	Rating
Power Supply Voltage (V_{CC})	-0.5 V to +3.75 V
Input Voltage (V_{IN})	$V_{CC} - 1.2$ V to $V_{CC} + 0.6$ V
Output Voltage (V_{OUT})	$V_{CC} - 1.2$ V to $V_{CC} + 0.6$ V
Delay Control Voltage (V_{DCP} , V_{DCN})	0 V to $V_{CC} + 0.6$ V
Power-Down (Enable) Pin (\overline{EN})	0 V to $V_{CC} + 0.6$ V
Amplitude Control (V_{AC})	0 V to $V_{CC} + 0.6$ V
Continuous Power Dissipation, P_{DISS} ($T_A = 85^\circ\text{C}$, Derate 54.96 mW/ $^\circ\text{C}$ above 85 $^\circ\text{C}$)	2.2 W
Thermal Resistance (Junction to Ground Paddle)	18.2 $^\circ\text{C}/\text{W}$
Channel Temperature (T_C)	125 $^\circ\text{C}$
Maximum Peak Reflow Temperature (MSL3) ¹	260 $^\circ\text{C}$
Storage Temperature Range	-65 $^\circ\text{C}$ to +125 $^\circ\text{C}$
Operating Temperature Range	-40 $^\circ\text{C}$ to +85 $^\circ\text{C}$
Electrostatic Discharge (ESD) Human Body Model (HBM)	Class 1B

¹ See the Ordering Guide section.

Stresses at or above those listed under Absolute Maximum Ratings may cause permanent damage to the product. This is a stress rating only; functional operation of the product at these or any other conditions above those indicated in the operational section of this specification is not implied. Operation beyond the maximum operating conditions for extended periods may affect product reliability.

ESD CAUTION



ESD (electrostatic discharge) sensitive device. Charged devices and circuit boards can discharge without detection. Although this product features patented or proprietary protection circuitry, damage may occur on devices subjected to high energy ESD. Therefore, proper ESD precautions should be taken to avoid performance degradation or loss of functionality.

PIN CONFIGURATION AND FUNCTION DESCRIPTIONS

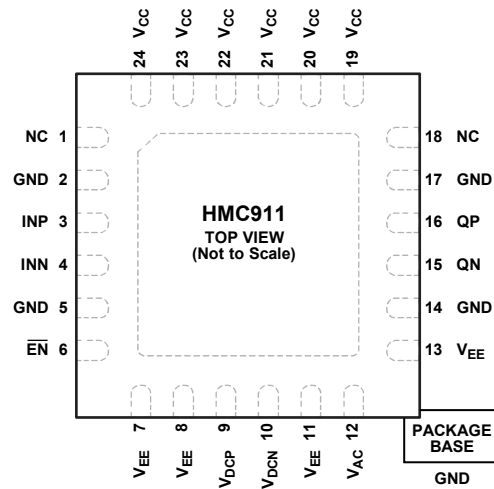

NOTES
 1. NC = NO CONNECT.
 2. EXPOSED PAD. CONNECT THE EXPOSED PAD TO RF/DC GROUND

14816-002

Figure 2. Pin Configuration

Table 3. Pin Function Descriptions

Pin No.	Mnemonic	Description
1, 18	NC	No Connect. These pins are not connected internally; however, all data shown herein was measured with these pins connected to RF/dc ground externally.
2, 5, 14, 17	GND	Ground Pin. Connect these signal grounds to 0 V. See Figure 3 for the interface schematic.
3	INP	Positive Differential RF Input Pin. See Figure 4 for the interface schematic.
4	INN	Negative Differential RF Input Pin. See Figure 4 for the interface schematic.
6	$\overline{\text{EN}}$	Enable Pin for the Time Delay. For normal operation, leave this pin open or apply 3.3 V. To disable the HMC911, apply 0 V. When disabled, the total current consumption drops to 15 mA. See Figure 5 for the interface schematic.
7, 8, 11, 13	V_{EE}	Supply Grounds. Connect these pins to 0 V. See Figure 6 for the interface schematic.
9	V_{DCP}	Positive Differential Time Delay Control Pin. See Figure 7 for the interface schematic.
10	V_{DCN}	Negative Differential Time Delay Control Pin. See Figure 7 for the interface schematic.
12	V_{AC}	Output Amplitude Control Pin. See Figure 8 for the interface schematic.
15	QN	Negative Differential RF Output Pin. See Figure 9 for the interface schematic.
16	QP	Positive Differential RF Output Pin. See Figure 9 for the interface schematic.
19 to 24	V_{CC}	Positive Supply Pins. See Figure 10 for the interface schematic.
	EPAD	Exposed Pad. Connect the exposed pad to RF/dc ground.

INTERFACE SCHEMATICS



Figure 3. GND Interface Schematic

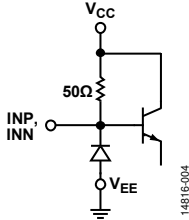

Figure 4. INP and INN Interface Schematic

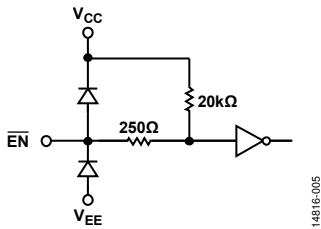

Figure 5. \overline{EN} Interface Schematic

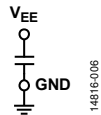

Figure 6. VEE Interface Schematic

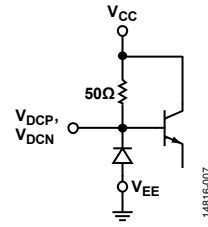

Figure 7. V_{DCP} and V_{DCN} Interface Schematic

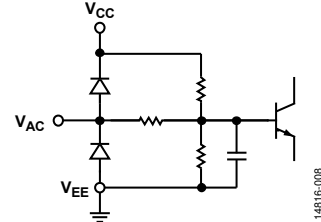

Figure 8. V_{AC} Interface Schematic

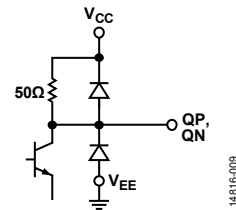

Figure 9. QN and QP Interface Schematic

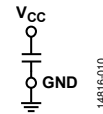

Figure 10. V_{CC} Interface Schematic

TYPICAL PERFORMANCE CHARACTERISTICS

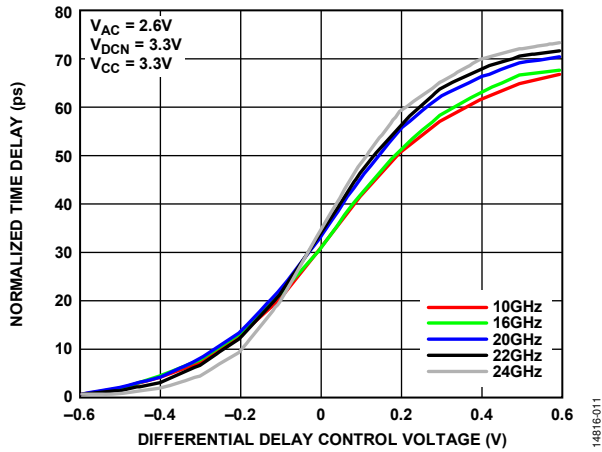

Figure 11. Normalized Time Delay vs. Differential Delay Control Voltage, Differential Delay Control Voltage Represents $V_{DCP} - V_{DCN}$ Voltage on the X-Axis

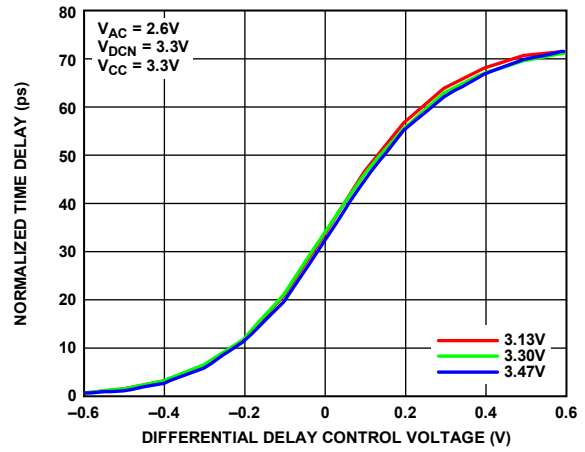

Figure 14. Normalized Time Delay vs. Differential Delay Control Voltage at 22 GHz for Various Voltages, Differential Delay Control Voltage Represents $V_{DCP} - V_{DCN}$ Voltage on the X-Axis

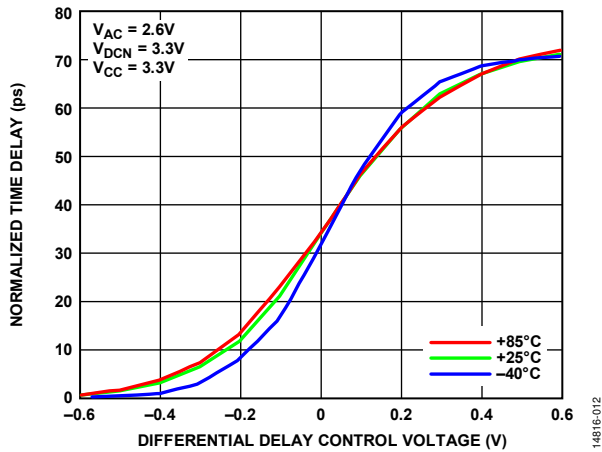

Figure 12. Normalized Time Delay vs. Differential Delay Control Voltage at 22 GHz for Various Temperatures, Differential Delay Control Voltage Represents $V_{DCP} - V_{DCN}$ Voltage on the X-Axis

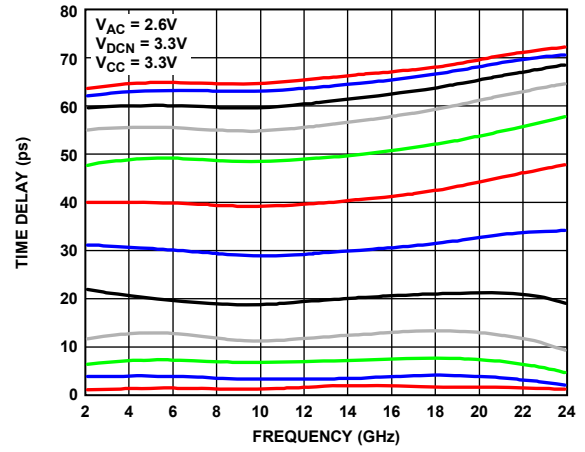

Figure 15. Time Delay vs. Frequency at $V_{DCP} = 2.7$ V to 3.9 V with 0.1 V Step

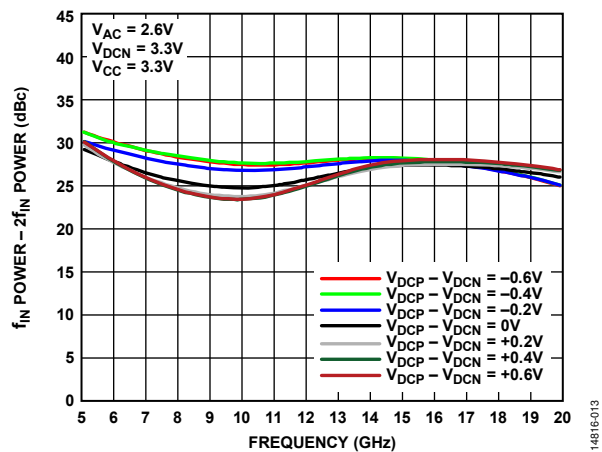

Figure 13. f_{IN} Power - $2f_{IN}$ Power vs. Frequency

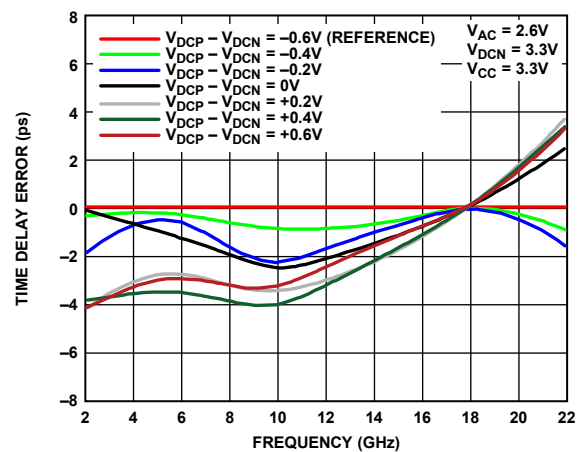

Figure 16. Time Delay Error vs. Frequency at Mean Frequency (f_{MEAN}) = 18 GHz

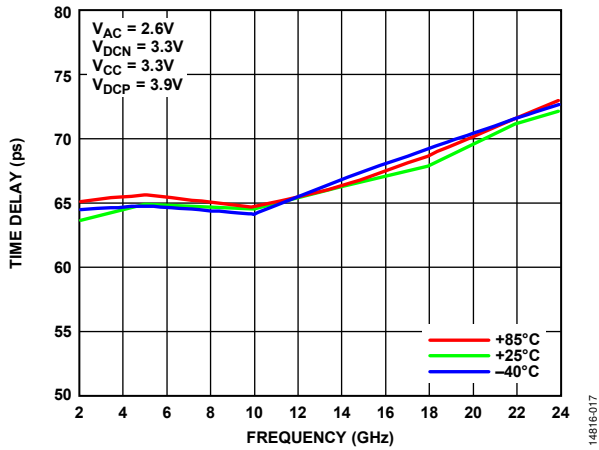

Figure 17. Programmable Maximum Time Delay vs. Frequency for Various Temperatures

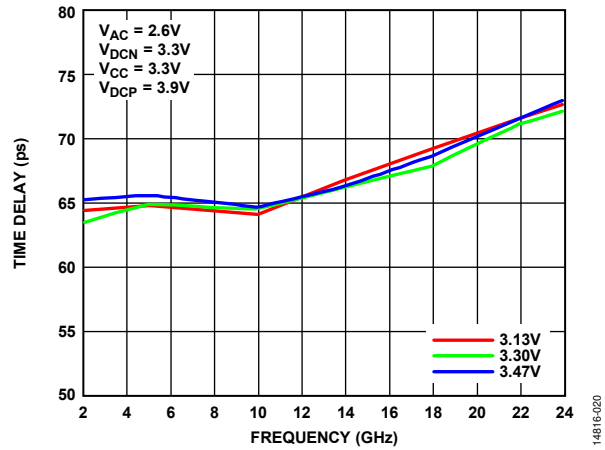

Figure 20. Programmable Maximum Time Delay vs. Frequency for Various Voltages

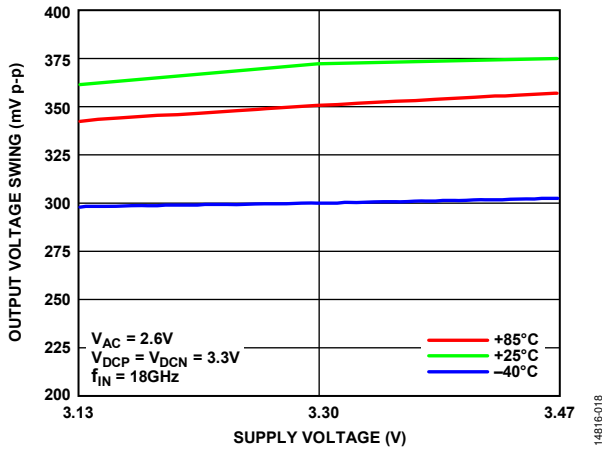

Figure 18. Single-Ended Output Voltage Swing vs. Supply Voltage for Various Temperatures

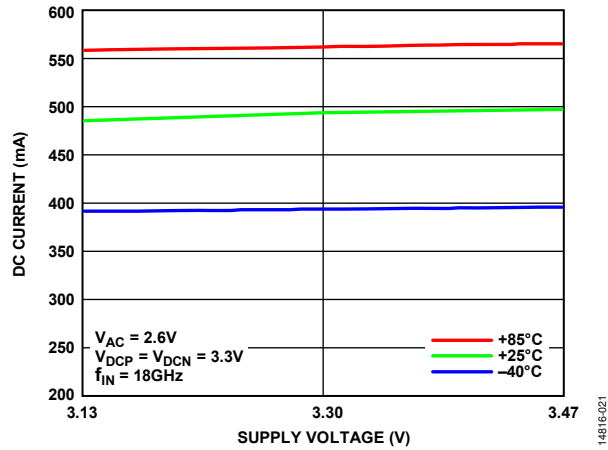

Figure 21. DC Current vs. Supply Voltage for Various Temperatures

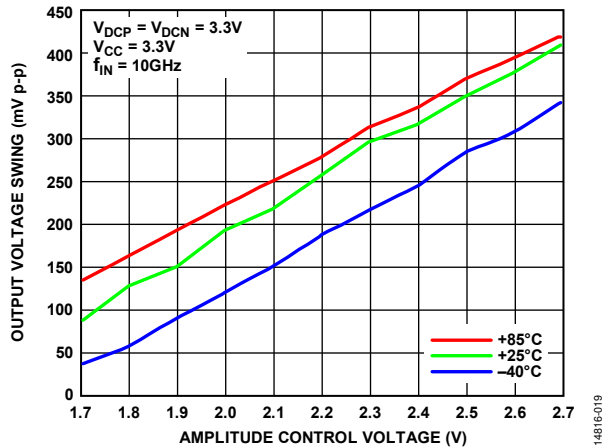

Figure 19. Single-Ended Output Voltage Swing vs. Amplitude Control Voltage (V_{AC}) for Various Temperatures

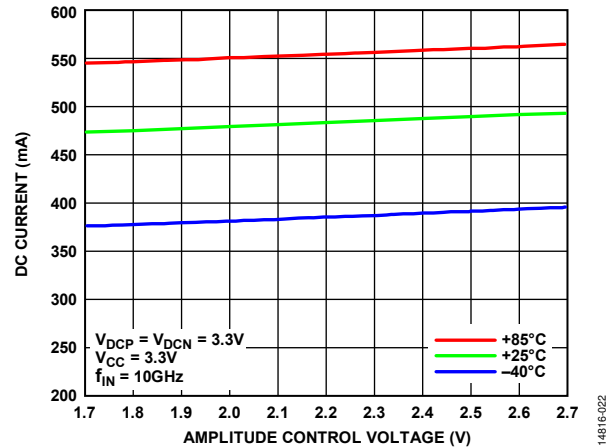

Figure 22. DC Current vs. Amplitude Control Voltage (V_{AC}) for Various Temperatures

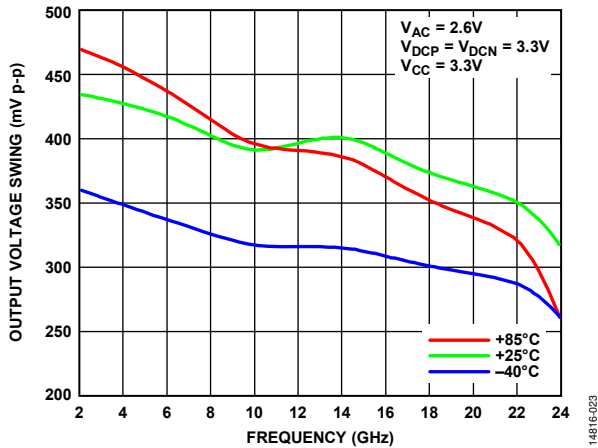

Figure 23. Single-Ended Output Voltage Swing vs. Frequency for Various Temperatures

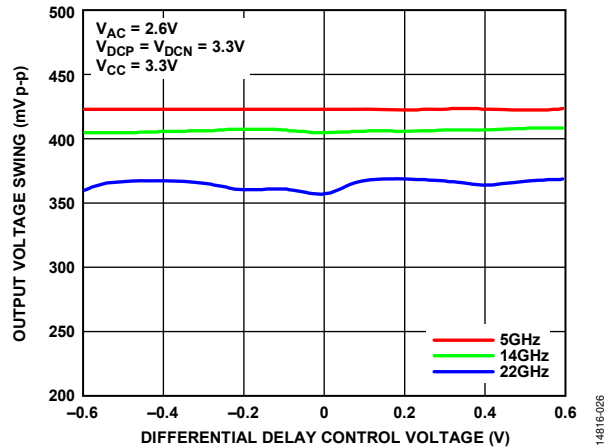

Figure 26. Single-Ended Output Voltage Swing vs. Differential Delay Control Voltage, Differential Control Voltage Represents $V_{DCP} - V_{DCN}$ Voltage on the X-Axis

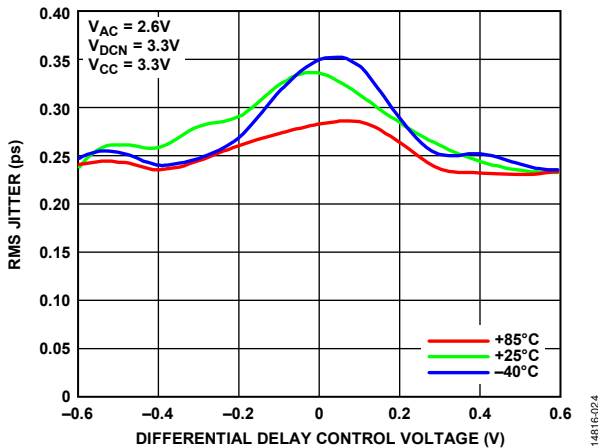

Figure 24. RMS Jitter vs. Differential Delay Control Voltage at 18 GHz for Various Temperatures, Differential Control Voltage Represents $V_{DCP} - V_{DCN}$ Voltage on the X-Axis

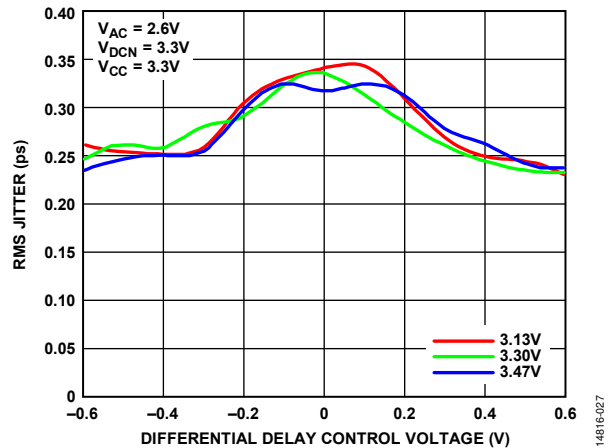

Figure 27. RMS Jitter vs. Differential Delay Control Voltage at 18 GHz for Various Voltages, Differential Control Voltage Represents $V_{DCP} - V_{DCN}$ Voltage on the X-Axis

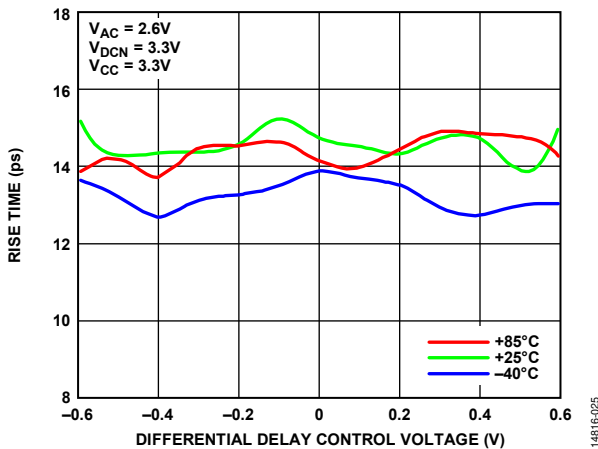

Figure 25. Rise Time vs. Differential Delay Control Voltage, Differential Control Voltage Represents $V_{DCP} - V_{DCN}$ Voltage on the X-Axis, Input Data Rate = 22.5 Gbps, PRBS $2^{33} - 1$

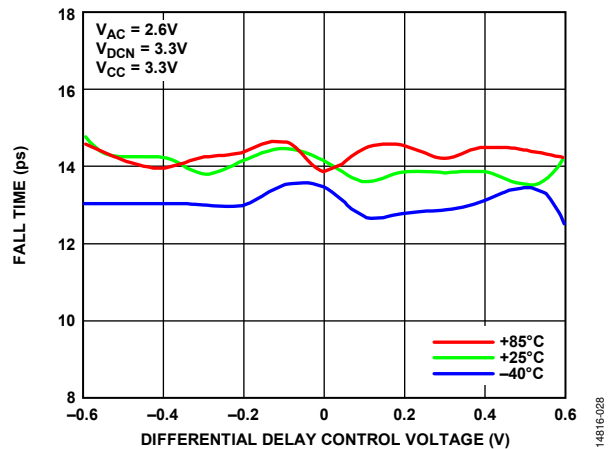

Figure 28. Fall Time vs. Differential Delay Control Voltage, Differential Control Voltage Represents $V_{DCP} - V_{DCN}$ Voltage on the X-Axis, Input Data Rate = 22.5 Gbps, PRBS $2^{33} - 1$

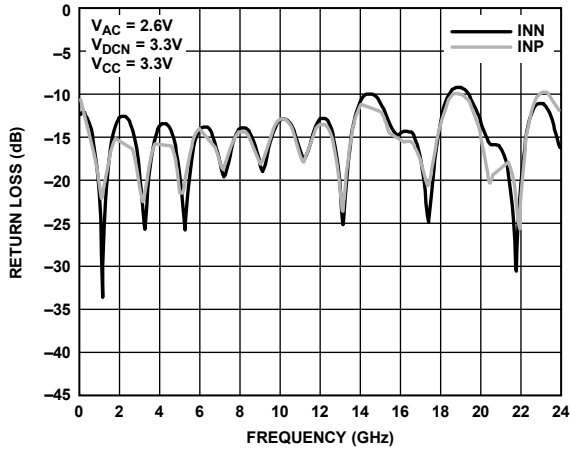

Figure 29. Input Return Loss vs. Frequency,

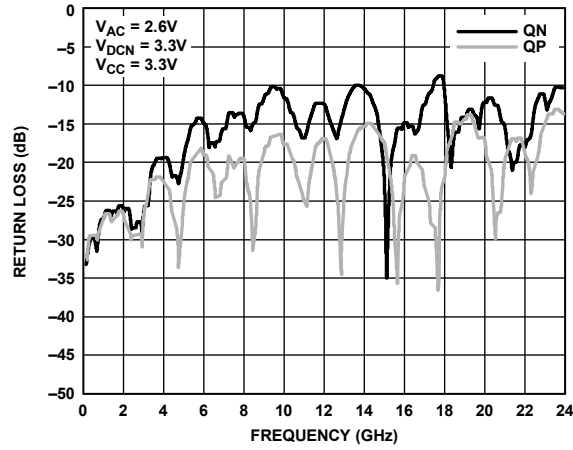

Figure 32. Output Return Loss vs. Frequency,

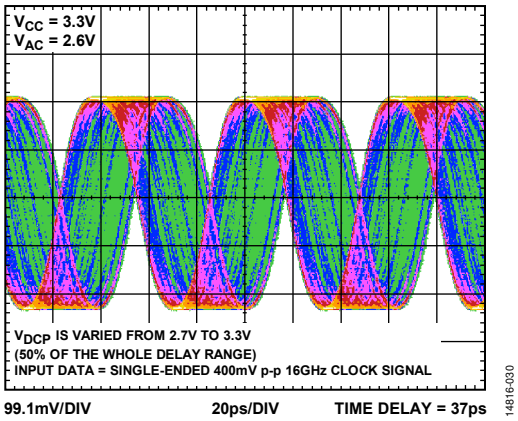

Figure 30. Output Eye Diagram Continuous Snapshot for 16 GHz Input

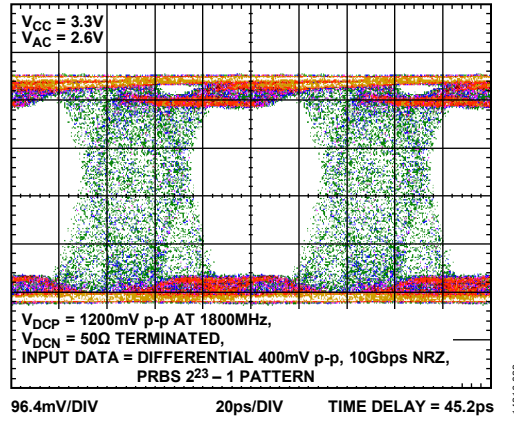

Figure 33. Output Eye Diagram Continuous Snapshot for 10 Gbps Input

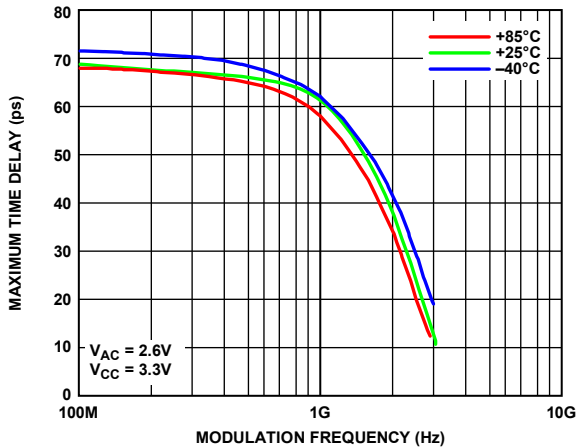

Figure 31. Maximum Time Delay vs. Modulation Frequency, Input Data Rate = 22.5 Gbps, PRBS 2²³ - 1, 6 dBm Input Power Applied to V_{DCP} and V_{DCN} Terminated to 50 Ω

APPLICATIONS INFORMATION

EVALUATION PRINTED CIRCUIT BOARD (PCB)

Generate the evaluation PCB used in this application with proper RF circuit design techniques. Signal lines at the RF port must have 50 Ω impedance, and the package ground leads and exposed paddle must be connected directly to the ground plane similar to what is shown in Figure 34. Use a sufficient number

of via holes to connect the top and bottom ground planes. Mount the evaluation board to an appropriate heat sink. The evaluation PCB shown is available from Analog Devices, Inc., upon request.

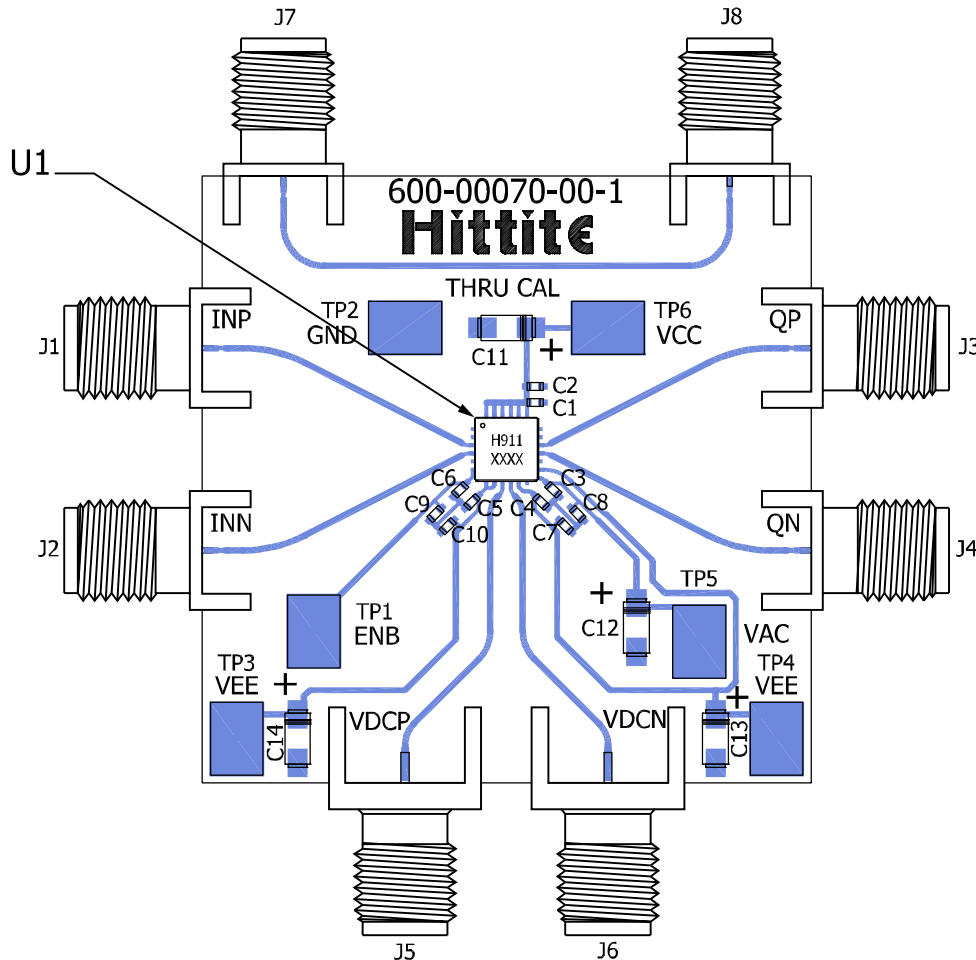

Figure 34. 600-00070-00-1 (EVAL01-HMC911LC4B) Evaluation Board

14816-035

Bill of Materials

Table 4.

Component	Description
J1 to J4	K connectors
J5, J6	SMA connectors
J7, J8	SMA connectors for through calibration
TP1 to TP6	DC test points
C1, C3 to C6	1 nF capacitors, 0402 package
C2, C7 to C10	0.1 μF capacitors, 0402 package
C9	100 nF capacitor, 0402 package
C11 to C14	4.7 μF tantalum capacitors
U1	HMC911 analog phase shifter
PCB	600-00070-00-1 (EVAL01-HMC911LC4B ¹) evaluation PCB, circuit board material: Rogers 4350 or Arlon 25 FR

¹ Reference this number when ordering the completed evaluation PCB.

TYPICAL APPLICATION CIRCUIT

Figure 35 shows the typical application circuit. Note that TP2 goes to ground and is not shown in Figure 35.

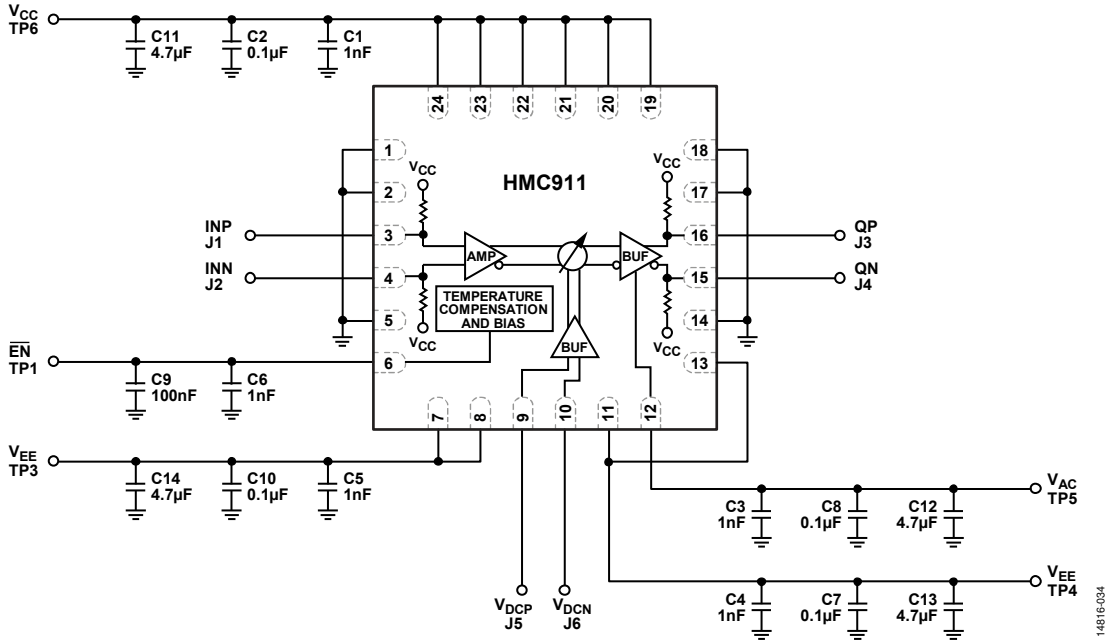

Figure 35. Typical Application Circuit

14816-034

OUTLINE DIMENSIONS

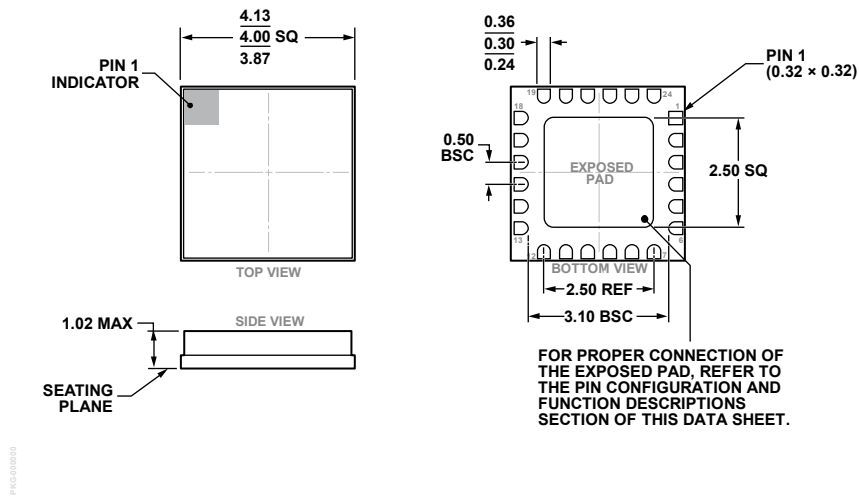

Figure 36. 24-Terminal Ceramic Leadless Chip [LCC] (E-24-1)
Dimensions shown in millimeters

ORDERING GUIDE

Model ¹	Temperature Range	Package Body Material	Lead Finish	MSL Rating ²	Package Description	Package Option
HMC911LC4B	-40°C to +85°C	Alumina, White	Gold over Nickel	MSL3	24-Terminal LCC	E-24-1
HMC911LC4BTR	-40°C to +85°C	Alumina, White	Gold over Nickel	MSL3	24-Terminal LCC	E-24-1
HMC911LC4BTR-R5	-40°C to +85°C	Alumina, White	Gold over Nickel	MSL3	24-Terminal LCC	E-24-1
EVAL01-HMC911LC4B					Evaluation Board	

¹ The HMC911LC4B, HMC911LC4BTR, and HMC911LC4BTR-R5 are RoHS Compliant Parts.

² See the Absolute Maximum Ratings section for additional information.