

PART NUMBER	SML-LX1210GGC-TR	REV	K
REV	E.C.N. NUMBER AND REVISION COMMENTS	DATE	
A	ADDED TAPE W/POLARITY AND DIRECTION	11.06.95	
B	E.C.N. #10196.	06.25.96	
C	E.C.N. #10324.	03.17.97	
D	E.C.N. #10404. & #10BRDR & REDRAWN.	05.22.98	
E	E.C.N. #10BRDR.	10.04.99	
F	E.C.N. #10695.	01.04.01	
G	E.C.N. #10972.	03.25.03	
H	E.C.N. #11148.	02.07.05	
I	E.C.N. #11508.	03.10.09	
J	E.C.N. #10BRDR & REDRAWN.	07.22.11	
K	ECN-Lumex201800160	10.22.18	

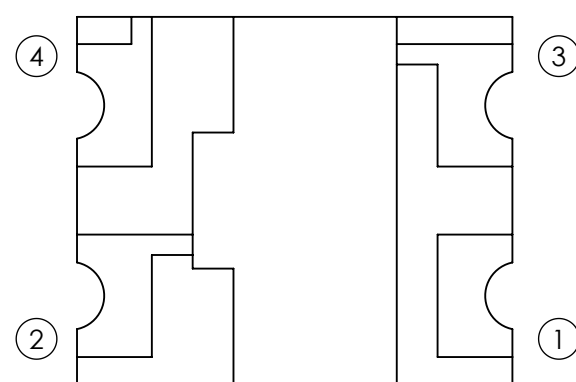

POLARITY

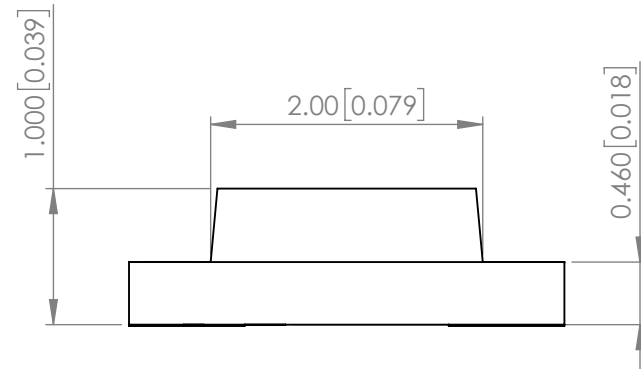
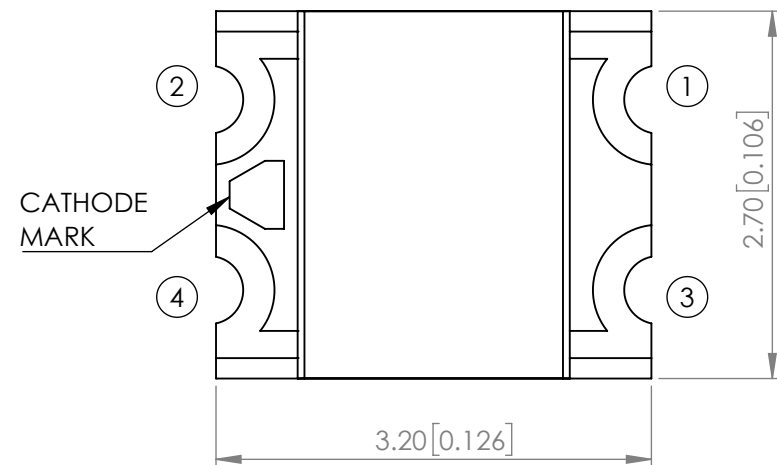
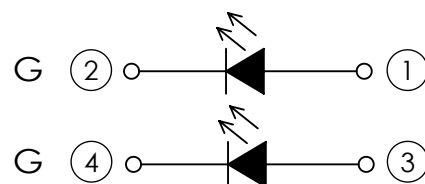

ELECTRO-OPTICAL CHARACTERISTIC TA=25°C

PARAMETER	MIN	TYP	MAX	UNITS	TEST COND
PEAK WAVELENGTH	-	570	-	nm	If=20mA
FORWARD VOLTAGE	-	2.1	2.4	Vf	If=20mA
REVERSE CURRENT	-	-	10	uA	VR=5V
LUMINOUS INTENSITY	-	10	-	mcd	If=20mA
VIEWING ANGLE	-	140	-	2x theta1/2	-
EMITTED COLOR	GREEN				
EPOXY LENS FINISH	WATER CLEAR				

RECOMMENDED SOLDER PAD LAYOUT

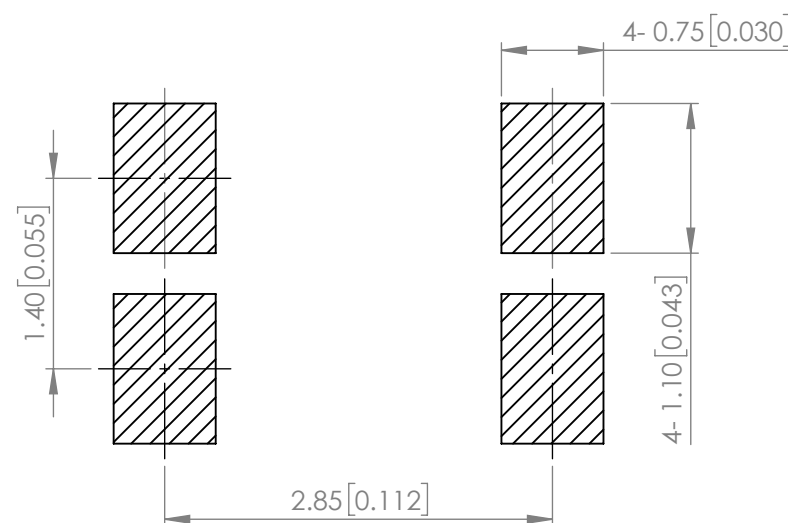

ABSOLUTE MAXIMUM RATINGS TA=25°C

PARAMETER	MAX	UNITS
PEAK FORWARD CURRENT	60	mA
FORWARD CURRENT	30	mA
REVERSE VOLTAGE	5	V
POWER DISSIPATION	72	mW
STORAGE TEMPERATURE	-40 TO +90	°C
OPERATING TEMPERATURE	-40 TO +85	°C
SOLDERING TEMPERATURE	3 SEC. MAX @ 260	°C

*t<10us

**MOISTURE SENSITIVE DEVICE
PER JEDEC LEVEL 3 STANDARDS**

*UNLESS OTHERWISE SPECIFIED TOLERANCES PER DECIMAL PRECISION ARE: X=±1 (±0.039), X.X=±0.5 (±0.020), X.XX=±0.25 (±0.010), X.XXX=±0.127 (±0.005). LEAD SIZE=±0.05 (±0.002), LEAD LENGTH=±0.75 (±0.030). MIN= ^{+DECIMAL PRECISION} -0.00 MAX= ^{+0.00} -DECIMAL PRECISION

 <p>425 N. GARY AVE. CAROL STREAM, IL 60188 PHONE : 800-278-5666 FAX : 630-315-2150 WEB : WWW.LUMEX.COM</p>	3.2(L)*2.7(W)*1.0(H)mm, PCB SURFACE MOUNT TOP VIEW LED, DUAL GaP 570nm GREEN CHIPS, WATER CLEAR LENS, TAPE & REEL.	DATE : 2018.10.22	DRAWN BY : C.C.
	THE SPECIFICATIONS MAY CHANGE AT ANY TIME WITHOUT NOTICE.	PAGE : 1 OF 2	CHKD BY : E.C.
	CONFIDENTIAL INFORMATION	SCALE : NTF	APRVD BY : G.Y.
	THE INFORMATION CONTAINED IN THIS DOCUMENT IS THE PROPERTY OF LUMEX INC. EXCEPT AS SPECIFICALLY AUTHORIZED IN WRITING BY LUMEX INC., THE HOLDER OF THIS DOCUMENT SHALL KEEP ALL INFORMATION CONTAINED HEREIN CONFIDENTIAL AND SHALL PROTECT SAME IN WHOLE OR IN PART FROM DISCLOSURE AND DISSEMINATION TO ALL THIRD PARTIES.	UNIT : mm [INCH]	Ⓢ

PROFILE

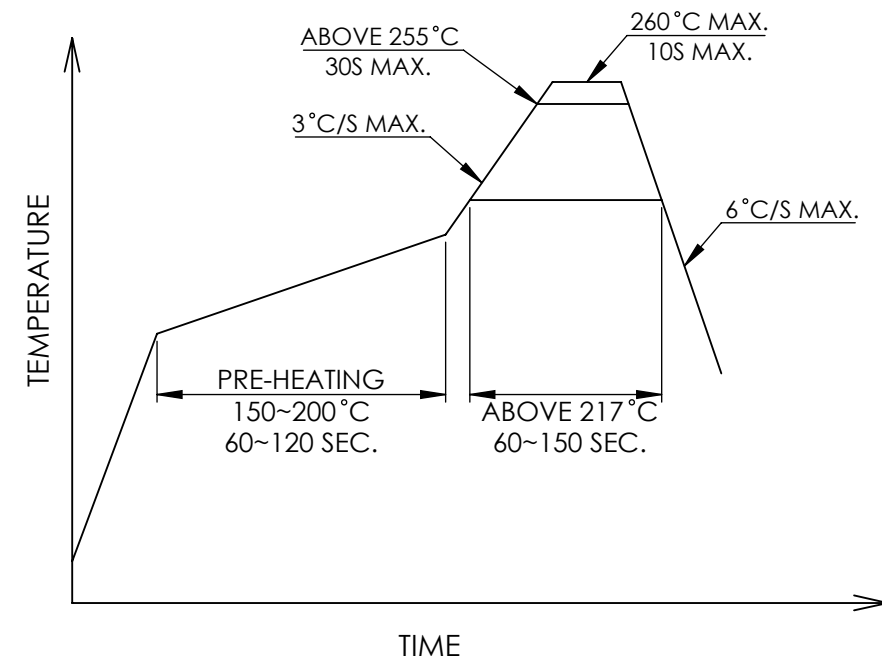

CARRIER TAPE DIMENSION

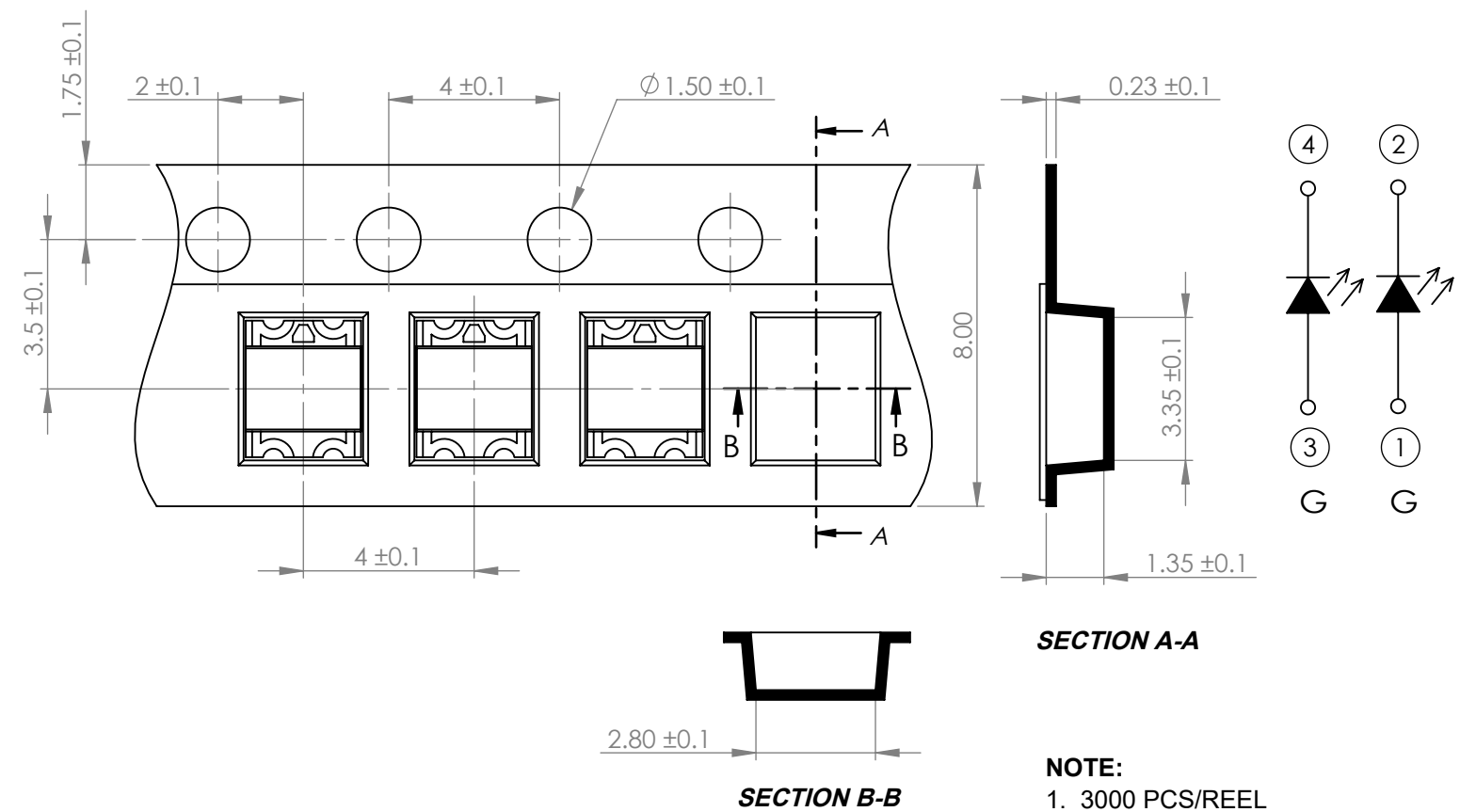

*UNLESS OTHERWISE SPECIFIED TOLERANCES PER DECIMAL PRECISION ARE: X=±1 (±0.039), X.X=±0.5 (±0.020), X.XX=±0.25 (±0.010), X.XXX=±0.127 (±0.005). LEAD SIZE=±0.05 (±0.002), LEAD LENGTH=±0.75 (±0.030). MIN= ^{+DECIMAL PRECISION}/_{-0.00} MAX.= ^{+0.00}/_{-DECIMAL PRECISION}



425 N. GARY AVE.
CAROL STREAM, IL 60188
PHONE : 800-278-5666
FAX : 630-315-2150
WEB : WWW.LUMEX.COM

3.2(L)*2.7(W)*1.0(H)mm, PCB SURFACE MOUNT TOP VIEW LED, DUAL GaP 570nm GREEN CHIPS, WATER CLEAR LENS, TAPE & REEL.

****THE SPECIFICATIONS MAY CHANGE AT ANY TIME WITHOUT NOTICE.****

CONFIDENTIAL INFORMATION
THE INFORMATION CONTAINED IN THIS DOCUMENT IS THE PROPERTY OF LUMEX INC. EXCEPT AS SPECIFICALLY AUTHORIZED IN WRITING BY LUMEX INC., THE HOLDER OF THIS DOCUMENT SHALL KEEP ALL INFORMATION CONTAINED HEREIN CONFIDENTIAL AND SHALL PROTECT SAME IN WHOLE OR IN PART FROM DISCLOSURE AND DISSEMINATION TO ALL THIRD PARTIES.

DATE : 2018.10.22	DRAWN BY : C.C.
PAGE : 2 OF 2	CHKD BY : E.C.
SCALE : NTF	APRVD BY : G.Y.
UNIT : mm [INCH]	Ⓝ