

THIS DRAWING IS UNPUBLISHED.

RELEASED FOR PUBLICATION

20

© COPYRIGHT 20

BY TYCO ELECTRONICS CORPORATION. ALL INTERNATIONAL RIGHTS RESERVED.

LOC GP DIST 00

REVISIONS

P	LTR	DESCRIPTION	DATE	DWN	APVD
	B	REV PER ECO-10-018470	10SEP2010	RG	DO

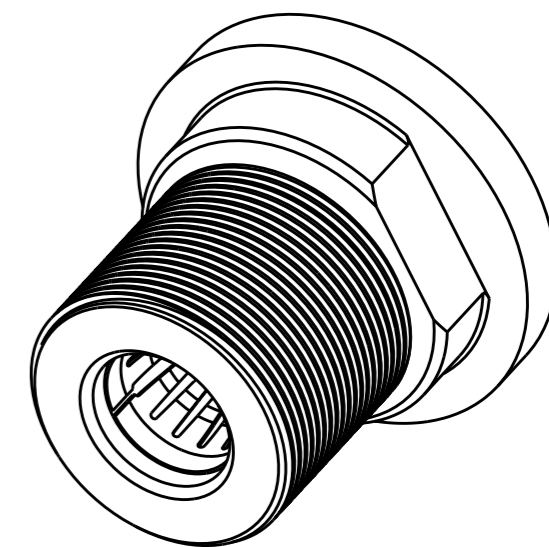
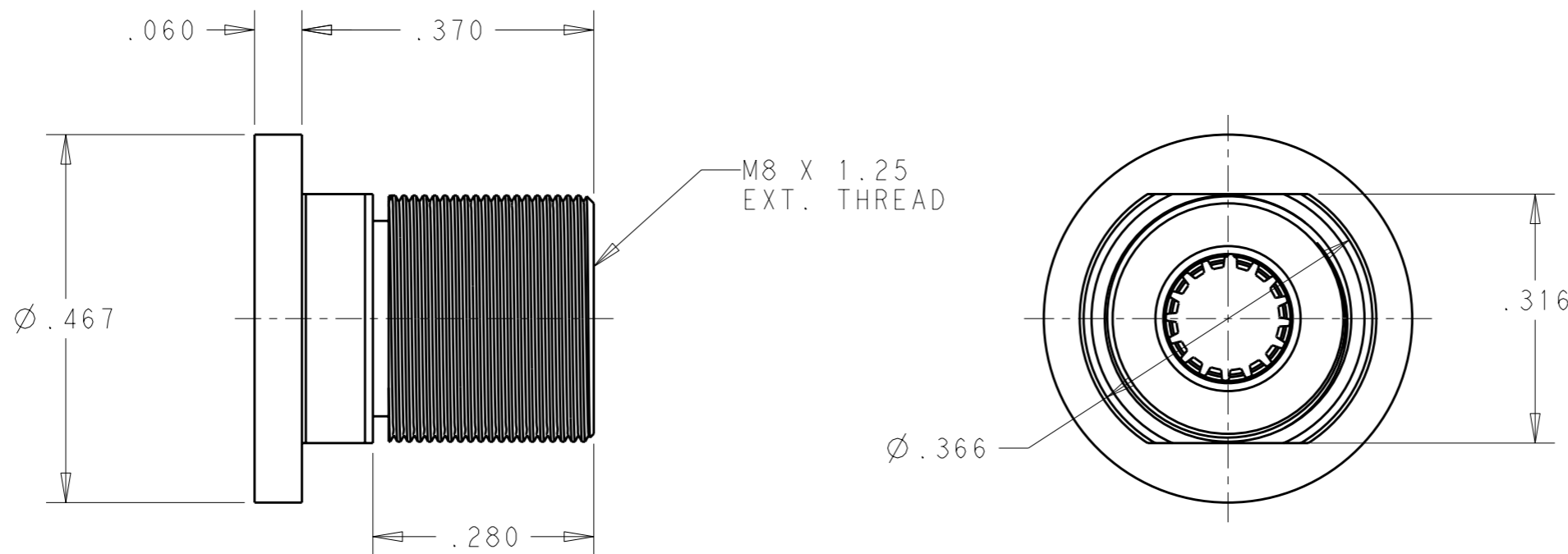

1 MATERIAL:
 SOCKET BODY: COPPER ALLOY
 CROWN BAND: BERYLLIUM COPPER

2 FINISH:
 SOCKET BODY: SILVER PLATE .000200 MIN THK. OVER NICKEL .000050 MIN THK.
 CROWN BAND: GOLD PLATE .000030 MIN THK. OVER NICKEL .000050 MIN THK.

AS SHOWN	2085459-1
DESCRIPTION	PART NUMBER

<small>THIS DRAWING IS A CONTROLLED DOCUMENT FOR TYCO ELECTRONICS CORPORATION IT IS SUBJECT TO CHANGE AND THE CONTROLLING ENGINEERING ORGANIZATION SHOULD BE CONTACTED FOR THE LATEST REVISION.</small>		DWN R.GRZYBOWSKI 28APR2010 CHK D.ORRIS 28APR2010 APVD M.PERCHEK 28APR2010		Tyco Electronics Corporation Harrisburg, PA 17105-3608	
DIMENSIONS: INCHES 		TOLERANCES UNLESS OTHERWISE SPECIFIED: 0 PLC ±- 1 PLC ±- 2 PLC ±.01 3 PLC ±.005 4 PLC ±-- ANGLES ±-		NAME SOCKET BODY SUB-ASSEMBLY CROWN INSERT PCB SOCKET	
MATERIAL - 1		FINISH - 2		PRODUCT SPEC - APPLICATION SPEC - WEIGHT -	
CUSTOMER DRAWING				SIZE A3 CAGE CODE 300779 DRAWING NO C-2085459	RESTRICTED TO -
				SCALE 5:1	SHEET 1 OF 1 REV B