

# XS518B1DAL5

Inductive proximity sensors XS, inductive sensor XS5 M18, L62mm, brass, Sn5mm, 12...48 VDC, cable 5 m



## Main

Range of Product	Telemecanique Inductive proximity sensors XS
Series name	General purpose
Sensor Type	Inductive proximity sensor
Device Application	-
Sensor name	XS5
Sensor design	Cylindrical M18
Size	56 mm
Body type	Fixed
Detector flush mounting acceptance	Flush mountable
Material	Metal
Type of output signal	Discrete
Wiring Technique	2-wire
[Sn] nominal sensing distance	0.20 in (5 mm)
Discrete output function	1 NO
Output circuit type	DC
Electrical connection	Cable
Cable length	16.40 ft (5 m)
[Us] rated supply voltage	12...48 V DC
Switching capacity in mA	1.5...100 mA DC overload and short-circuit protection
IP degree of protection	IP68 double insulation conforming to IEC 60529 IP69K conforming to DIN 40050

## Complementary

Thread type	M18 x 1
Detection face	Frontal
Front material	PPS
Enclosure Material	Nickel Plated Brass
Operating zone	0.00...0.16 in (0...4 mm)
Differential travel	1...15% of Sr
Cable composition	2 x 0.34 mm <sup>2</sup>
Wire insulation material	PvR
Status LED	Output state 1 LED yellow)
Supply voltage limits	10...58 V DC
Maximum residual current	0.5 mA open state
Switching frequency	<= 3000 Hz
Maximum voltage drop	<4 V closed)
Maximum delay first up	10 ms
Maximum delay response	0.15 ms
Maximum delay recovery	0.2 ms
Marking	CE
Threaded length	2.05 in (52 mm)
Length	2.44 in (62 mm)
Net Weight	0.53 lb(US) (0.24 kg)

## Environment

Product Certifications	UL CSA CCC
Ambient Air Temperature for Operation	-13...158 °F (-25...70 °C)
Ambient Air Temperature for Storage	-40...185 °F (-40...85 °C)
Vibration resistance	25 gn +/- 2 mm 10...55 Hz)IEC 60068-2-6
Shock resistance	50 gn 11 ms IEC 60068-2-27

## Ordering and shipping details

Category	22486-SENSORS, PROXIMITY
Discount Schedule	DS2
GTIN	3389110129342
Nbr. of units in pkg.	1
Package weight(Lbs)	5.93 oz (168.0 g)
Returnability	No
Country of origin	FR

## Packing Units

Unit Type of Package 1	PCE
Package 1 Height	1.57 in (4 cm)
Package 1 width	5.43 in (13.8 cm)
Package 1 Length	5.04 in (12.8 cm)
Unit Type of Package 2	S02
Number of Units in Package 2	12
Package 2 Weight	5.79 lb(US) (2.628 kg)
Package 2 Height	5.91 in (15 cm)
Package 2 width	11.81 in (30 cm)
Package 2 Length	15.75 in (40 cm)
Package 3 Height	5.91 in (15 cm)

## Offer Sustainability

Sustainable offer status	Green Premium product
California proposition 65	WARNING: This product can expose you to chemicals including: Diisononyl phthalate (DINP), which is known to the State of California to cause cancer, and Di-isodecyl phthalate (DIDP), which is known to the State of California to cause birth defects or other reproductive harm. For more information go to <a href="http://www.P65Warnings.ca.gov">www.P65Warnings.ca.gov</a>
REACH Regulation	<a href="#">REACH Declaration</a>
EU RoHS Directive	Pro-active compliance (Product out of EU RoHS legal scope) <a href="#">EU RoHS Declaration</a>
Mercury free	Yes
RoHS exemption information	<a href="#">Yes</a>
Environmental Disclosure	<a href="#">Product Environmental Profile</a>
Circularity Profile	<a href="#">End Of Life Information</a>

## Contractual warranty

Warranty	18 months
----------	-----------

Dimensions

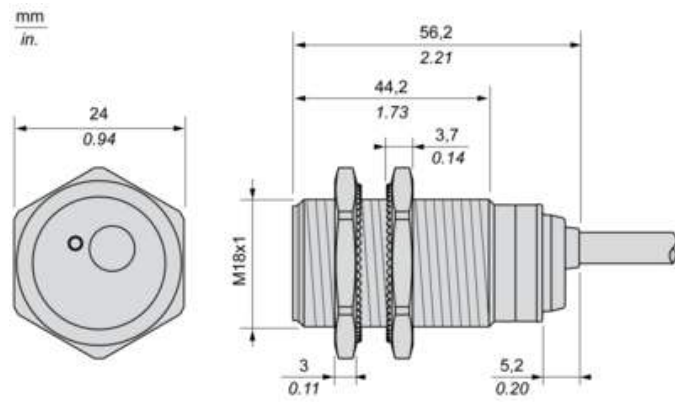

---

Minimum Mounting Distances

---

Side by side

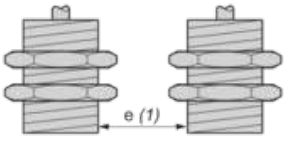

$e (1) \geq 10 \text{ mm}/0.39 \text{ in.}$

Face to face

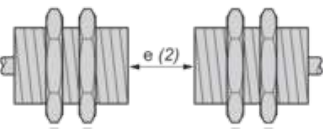

$e (2) \geq 60 \text{ mm}/2.36 \text{ in.}$

Facing a metal object

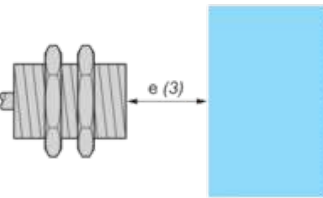

$e (3) \geq 15 \text{ mm}/0.60 \text{ in.}$

---

Mounting

---

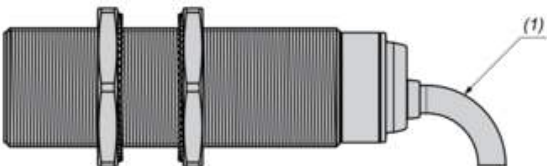

(1) Bending cable: 4 x external cable diameter

---

## Wiring Schemes

---

### 2-Wire Non-polarised

NO output

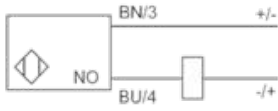

BU : Blue

BN : Brown

## Performance Curves

Standard Steel Target : 18x18x1 mm

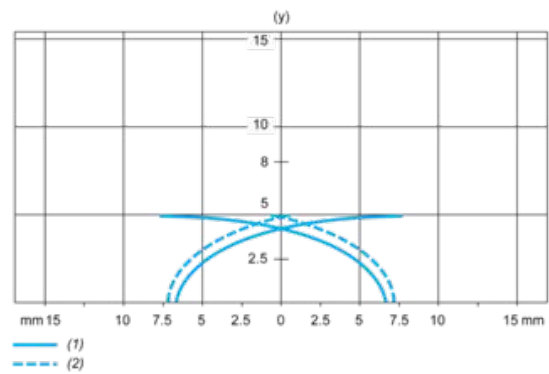

(1) Pick-up points

(2) Drop-out points (object approaching from the side)

(y) Sensing distance in mm