

TPS65286 Dual Power Distribution Switches With 4.5-V to 28-V Input Voltage, 6-A Output Current Synchronous Buck Regulator

1 Features

- Integrated Dual Power Distribution Switches:
 - 2.5 V to 6 V Operating Input Voltage Range
 - Integrated Back-to-Back Power MOSFETs With Typical 100-mΩ On-Resistance
 - Adjustable Current Limiting from 75 mA to 2.7 A
 - ±6% Current-Limit Accuracy at 1.2 A (Typical)
 - Latch-off Over Current Protection Versions
 - Reverse Input-Output Voltage Protection
 - Built-In Soft-Start
- Integrated Buck DCDC Converter:
 - 4.5 V to 28 V Wide Input Voltage Range
 - Maximum Continuous 6-A Output Load Current
 - Feedback Reference Voltage 0.6 V ±1%
 - Fixed 500-kHz Switching Frequency
 - Built-In Internal Soft-Start Time: 1 ms
 - Cycle-by-Cycle Current Limit
 - Adjustable Current Limit Threshold
 - Output Over-Voltage Protection
 - External Clock Synchronization
 - Over Temperature Protection

2 Applications

- USB Ports and USB Hubs
- Digital TV
- Computing Power
- Laptop Dock
- Car Infotainment
- Monitoring

4 Simplified Schematic

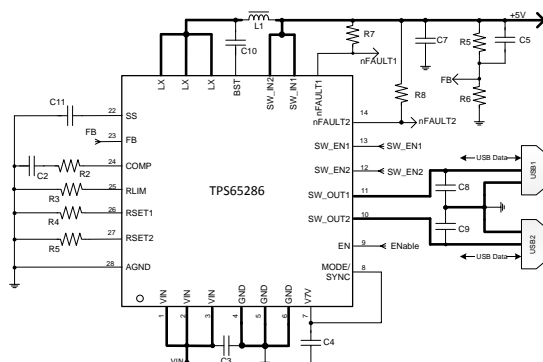

3 Description

The TPS65286 is a full featured 4.5-V to 28-V V_{IN} , 6-A output current synchronous step down DCDC converter, which is optimized for small designs through high efficiency and integrating the high-side and low-side MOSFETs. The device also incorporates dual N-channel MOSFET power switches for power distribution systems. This device provides a total power distribution solution, where precision current limiting and fast protection response are required.

A dual 100-mΩ independent power distribution switch limits the output current to a programmable current limit threshold between typical 50 mA~2.7 A by using an external resistor. The current limit accuracy can be achieved as tightly as ±6% at typical 1.2 A. The nFAULT output asserts low under over-current and reverse-voltage conditions.

Constant frequency peak current mode control in the DCDC converter simplifies the compensation and optimizes transient response. Cycle-by-cycle over-current protection and operating in hiccup mode limit MOSFET power dissipation. When die temperature exceeds thermal over loading threshold, the over temperature protection shuts down the device.

Device Information

ORDER NUMBER	PACKAGE	BODY SIZE
TPS65286RHD	VQFN (28)	5 mm x 5 mm



Table of Contents

1 Features	1	8.2 Functional Block Diagram	14
2 Applications	1	8.3 Feature Description	15
3 Description	1	8.4 Device Functional Modes	23
4 Simplified Schematic	1	9 Application and Implementation	24
5 Revision History	2	9.1 Application Information	24
6 Terminal Configuration and Functions	3	9.2 Typical Applications	24
7 Specifications	5	10 Power Supply Recommendations	34
7.1 Absolute Maximum Ratings	5	11 Layout	36
7.2 Handling Ratings	5	11.1 Layout Guidelines	36
7.3 Recommended Operating Conditions	5	11.2 Layout Example	37
7.4 Thermal Information	6	12 Device and Documentation Support	38
7.5 Electrical Characteristics	6	12.1 Trademarks	38
7.6 Typical Characteristics	10	12.2 Electrostatic Discharge Caution	38
8 Detailed Description	13	12.3 Glossary	38
8.1 Overview	13	13 Mechanical, Packaging, and Orderable Information	38

5 Revision History

DATE	VERSION	NOTES
March 2014	*	Initial release

6 Terminal Configuration and Functions

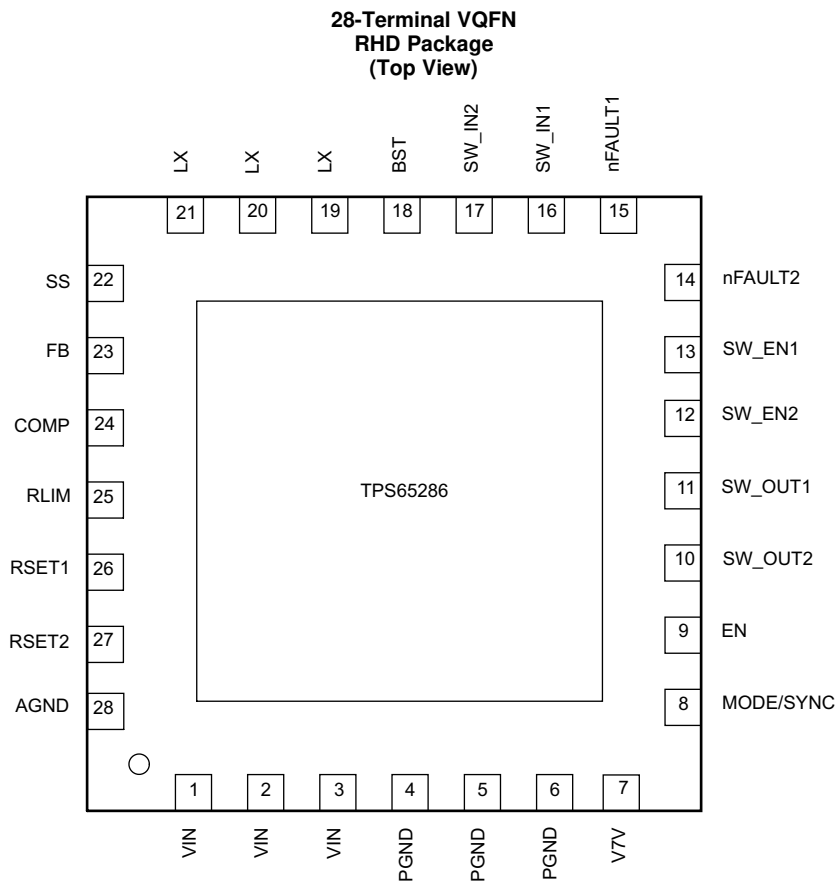

There is no electric signal down bonded to thermal pad inside IC. Exposed thermal pad must be soldered to PCB for optimal thermal performance.

Terminal Functions

NAME	NO.	DESCRIPTION
VIN	1, 2, 3	Input power supply for buck. Connect this terminal as close as practical to the (+) terminal of an input ceramic capacitor (suggest 22 μ F).
PGND	4, 5, 6	Power ground connection. Connect this terminal as close as practical to the (-) terminal of input capacitor.
V7V	7	Internal low-drop linear regulator (LDO) output. The internal driver and control circuits are powered from this voltage. Decouple this terminal to power ground with a minimum 1-M μ F ceramic capacitor. The output voltage level of LDO is regulated to typical 6.3 V for optimal conduction on-resistances of internal power MOSFETs. In PCB design, the power ground and analog ground should have one-point common connection at the (-) terminal of V7V bypass capacitor.
MODE/SYNC	8	External synchronization input to internal clock oscillator in forced continuous mode. When an external clock is applied to this terminal, the internal oscillator will force the rising edge of clock signal to be synchronized with the falling edge of the external clock. Connecting this terminal to ground forces a continuous current mode (CCM) operation in buck converter. Connecting this terminal to V7V the buck converter will automatically operate in pulse skipping mode (PSM) at light load condition to save the power.
EN	9	Enable for buck converter. Adjust the input under-voltage lockup with two resistors.
SW_OUT2	10	Power switch 2 output
SW_OUT1	11	Power switch 1 output
SW_EN2	12	Enable power switch 2. There is an internal 1.25-M Ω pull-up resistor connecting this terminal to SW_IN2.
SW_EN1	13	Enable power switch 1. There is an internal 1.25-M Ω pull-up resistor connecting this terminal to SW_IN1.
nFAULT2	14	Active low open drain output, asserted during over-current or reverse-voltage condition of power switch 2.
nFAULT1	15	Active low open drain output, asserted during over-current or reverse-voltage condition of power switch 1.
SW_IN1	16	Power switch input voltage for USB1. Connect to buck output, or other power supply input.
SW_IN2	17	Power switch input voltage for USB2. Connect to buck output, or other power supply input.
BST	18	Bootstrapped supply to the high side floating gate driver in buck converter. Connect a capacitor (recommend 47 nF) from this terminal to LX.
LX	19, 20, 21	Switching node connection to the inductor and bootstrap capacitor for buck converter. This terminal voltage swings from a diode voltage below the ground up to V_{IN} voltage.
SS	22	Soft-start and tracking input for buck converter. An internal 5.5- μ A pull-up current source is connected to this terminal. An external soft-start can be programmed by connecting a capacitor between this terminal and ground. Leave the terminal floating to have a default 1ms of soft-start time. This terminal allows the start-up of buck output to track an external voltage using an external resistor divider at this terminal.
FB	23	Feedback sensing terminal for buck output voltage. Connect this terminal to the resistor divider of buck output. The feedback reference voltage is 0.6 V \pm 1%.
COMP	24	Error amplifier output and Loop compensation terminal for buck. Connect a series resistor and capacitor to compensate the control loop of buck converter with peak current PWM mode.
RLIM	25	BUCK current limit control terminal. An external resistor used to set current limit threshold of buck converter. Recommended 120 k Ω \leq RLIM \leq 450k Ω . Connect this terminal to GND, set the current limit to 8 A.
RSET1	26	Power switch current limit control terminal. An external resistor used to set current limit threshold of power switch 1. Recommended 9.1 k Ω \leq RLIM \leq 300 k Ω .
RSET2	27	Power switch current limit control terminal. An external resistor used to set current limit threshold of power switch 2. Recommended 9.1 k Ω \leq RLIM \leq 300 k Ω .
AGND	28	Analog ground common to buck controller and power switch controller. AGND must be routed separately from high current power grounds to the (-) terminal of bypass capacitor of internal V7V LDO output.
Power PAD		Exposed pad beneath the IC. Connect to the power ground. Always solder power pad to the board, and have as many vias as possible on the PCB to enhance power dissipation. There is no electric signal down bonded to pad inside the IC package.

7 Specifications

7.1 Absolute Maximum Ratings⁽¹⁾

over operating free-air temperature range (unless otherwise noted)

	VALUE	UNIT
Voltage range at VIN, LX	–0.3 to 30	V
Voltage range at LX (maximum withstand voltage transient < 20 ns)	–1 to 30	V
Voltage at BST referenced to LX terminal	–0.3 to 7	V
Voltage at SW_IN1, SW_OUT1, SW_IN2, SW_OUT2	–0.3 to 7	V
Voltage at EN, SW_EN1, SW_EN2, nFAULT1, nFAULT2, V7V, MODE/SYNC	–0.3 to 7	V
Voltage at SS, COMP, RLIM, RSET1, RSET2, FB	–0.3 to 3.6	V
Voltage at AGND, PGND	–0.3 to 0.3	V
T _J Operating virtual junction temperature range	–40 to 125	°C

- (1) Stresses beyond those listed under "absolute maximum ratings" may cause permanent damage to the device. These are stress ratings only, and functional operation of the device at these or any other conditions beyond those indicated under "recommended operating conditions" is not implied. Exposure to absolute–maximum–rated conditions for extended periods may affect device reliability.

7.2 Handling Ratings

PARAMETER	DEFINITION	MIN	MAX	UNIT
T _{stg}	Storage temperature range	–55	150	°C
V _{ESD} ⁽¹⁾	Human body model (HBM) ESD stress voltage ⁽²⁾	2000		V
	Charge device model (CDM) ESD stress voltage ⁽³⁾	500		

- (1) Electrostatic discharge (ESD) to measure device sensitivity/immunity to damage caused by assembly line electrostatic discharges into the device.
- (2) Level listed above is the passing level per ANSI/ESDA/JEDEC JS-001. JEDEC document JEP155 states that 500-V HBM allows safe manufacturing with a standard ESD control process. *Terminals listed as 1 kV may actually have higher performance.*
- (3) Level listed above is the passing level per EIA-JEDEC JESD22-C101. JEDEC document JEP157 states that 250-V CDM allows safe manufacturing with a standard ESD control process. *Terminals listed as 250 V may actually have higher performance.*

7.3 Recommended Operating Conditions

over operating free-air temperature range (unless otherwise noted)

	MIN	NOM	MAX	UNIT
V _{IN} Input operating voltage	4.5		28	V
T _A Ambient temperature	–40		125	°C

7.4 Thermal Information

THERMAL METRIC ⁽¹⁾		TPS65286	UNIT
		RHD	
		28 TERMINAL	
$R_{\theta JA}$	Junction-to-ambient thermal resistance ⁽²⁾	35.6	°C/W
$R_{\theta Jc top}$	Junction-to-case (top) thermal resistance ⁽³⁾	24.2	
$R_{\theta JB}$	Junction-to-board thermal resistance ⁽⁴⁾	7.9	
$R_{\psi JT}$	Junction-to-top characterization parameter ⁽⁵⁾	0.3	
$R_{\psi JB}$	Junction-to-board characterization parameter ⁽⁶⁾	7.96	
$R_{\theta Jc bot}$	Junction-to-case (bottom) thermal resistance ⁽⁷⁾	1.1	

(1) For more information about traditional and new thermal metrics, see the *IC Package Thermal Metrics* application report, [SPRA953](#).

(2) The junction-to-ambient thermal resistance under natural convection is obtained in a simulation on a JEDEC-standard, high-K board, as specified in JESD51-7, in an environment described in JESD51-2a.

(3) The junction-to-case (top) thermal resistance is obtained by simulating a cold plate test on the package top. No specific JEDEC-standard test exists, but a close description can be found in the ANSI SEMI standard G30-88.

(4) The junction-to-board thermal resistance is obtained by simulating in an environment with a ring cold plate fixture to control the PCB temperature, as described in JESD51-8.

(5) The junction-to-top characterization parameter, ψ_{JT} , estimates the junction temperature of a device in a real system and is extracted from the simulation data for obtaining θ_{JA} , using a procedure described in JESD51-2a (sections 6 and 7).

(6) The junction-to-board characterization parameter, ψ_{JB} , estimates the junction temperature of a device in a real system and is extracted from the simulation data for obtaining θ_{JA} , using a procedure described in JESD51-2a (sections 6 and 7).

(7) The junction-to-case (bottom) thermal resistance is obtained by simulating a cold plate test on the exposed (power) pad. No specific JEDEC standard test exists, but a close description can be found in the ANSI SEMI standard G30-88.

7.5 Electrical Characteristics

$T_J = 25^\circ\text{C}$, $V_{IN} = 24\text{ V}$, $f_{SW} = 500\text{ kHz}$, $R_{nFAULTx} = 100\text{ k}\Omega$ (unless otherwise noted)

PARAMETER	TEST CONDITIONS	MIN	TYP	MAX	UNIT	
INPUT SUPPLY						
V_{IN}	Input voltage range	VIN1 and VIN2	4.5	28	V	
I_{DDSDN}	Shutdown supply current	EN1 = EN2 = low	7.60	15	μA	
I_{DDQ_NSW}	Quiescent current without buck switching	EN = high, ENx = low, FB = 1 V Without buck switching	0.8		mA	
I_{DDQ_SW}	Input quiescent current with buck switching	EN = high, ENx = low, FB = 0.6 V With buck switching	26		mA	
UVLO	V_{IN} under voltage lockout	Rising V_{IN}	4	4.25	4.50	V
		Falling V_{IN}	3.75	4	4.25	
		Hysteresis		0.25		
V_{7V}	Low side gate driver, controller, biasing supply	V_{7V} load current = 0 A, $V_{IN} = 24\text{ V}$	6.10	6.25	6.4	V
I_{OCP_V7V}	Current limit of V7V LDO		83		mA	
ENABLE						
V_{ENR}	Enable threshold	Rising		1.21	1.26	V
V_{ENF}	Enable threshold	Falling	1.10	1.17		V
I_{ENL}	Enable pull-up current	EN = 1 V		3		μA
I_{ENH}	Enable pull-up current	EN = 1.5 V		6		μA
I_{ENHYS}	Enable hysteresis current			3		μA

Electrical Characteristics (continued)
 $T_J = 25^\circ\text{C}$, $V_{IN} = 24\text{ V}$, $f_{SW} = 500\text{ kHz}$, $R_{nFAULTx} = 100\text{ k}\Omega$ (unless otherwise noted)

PARAMETER		TEST CONDITIONS	MIN	TYP	MAX	UNIT
OSCILLATOR						
f_{SW}	Switching frequency	Internal oscillator clock frequency	400	500	600	kHz
T_{SYNC_w}	Clock sync minimum pulse width		80			ns
V_{SYNC_HI}	Clock sync high threshold				2	V
V_{SYNC_LO}	Clock sync low threshold		0.8			V
V_{SYNC_D}	Clock falling edge to LX rising edge delay				120	ns
f_{SYNC}	Clock sync frequency range		200		1600	kHz
BUCK CONVERTER						
V_{IN}	Input supply voltage		4.5		28	V
V_{FB}	Feedback voltage	$V_{COMP} = 1.2\text{ V}$, $T_J = 25^\circ\text{C}$	0.594	0.6	0.606	%V
		$V_{COMP} = 1.2\text{ V}$, $T_J = 40^\circ\text{C}$ to 125°C	0.588	0.6	0.612	
G_{m_EA}	Error amplifier trans-conductance	$-4\text{ }\mu\text{A} < I_{COMP} < 4\text{ }\mu\text{A}$		1240		μS
G_{m_SRC}	COMP voltage to inductor current $G_m^{(1)}$	$I_{LX} = 0.5\text{ A}$		9.2		A/V
I_{SS}	Soft-Start terminal charging current	SS = 1 V		5.5		μA
T_{SS_INT}	Internal Soft-Start time	SS terminal floats	0.5	1	1.5	ms
I_{LIMIT}	Buck peak inductor current limit	$R_{LIM} = 0\text{ }\Omega$	6.6	7.7	8.7	A
		$R_{LIM} = 200\text{ k}\Omega$		5.2		
T_{ON_MIN}	Minimum on time (current sense blanking)			85	120	ns
R_{dson_HS}	On resistance of high side FET	$V_{7V} = 6.25\text{ V}$, includes bondwire resistance		55		m Ω
R_{dson_LS}	On resistance of low side FET	$V_{IN} = 24\text{ V}$, includes bondwire resistance		30		m Ω
$T_{hiccupwait}$	Hiccup wait time			256		cycles
T_{hiccup_re}	Hiccup time before re-start			8192		cycles
POWER DISTRIBUTION SWITCH						
V_{SW_IN}	Power switch input voltage range		2.5		6	V
V_{UVLO_SW}	Input under-voltage lock out	V_{SW_IN} rising	2.15	2.25	2.35	V
		V_{SW_IN} falling	2.05	2.15	2.25	
		Hysteresis		0.1		
R_{DSON_SW}	Power switch NDMOS on-resistance	$V_{SW_INx} = 5\text{ V}$, $I_{SW_OUTx} = 0.5\text{ A}$, $T_J = 25^\circ\text{C}$, includes bondwire resistance		100		m Ω
		$V_{SW_INx} = 2.5\text{ V}$, $I_{SW_OUTx} = 0.5\text{ A}$, $T_J = 25^\circ\text{C}$, includes bondwire resistance		100		
t_{D_on}	Turn-on delay time			1.26	1.9	ms
t_{D_off}	Turn-off delay time	$V_{SW_INx} = 5\text{ V}$, $C_L = 10\text{ }\mu\text{F}$, $R_L = 100\text{ }\Omega$ (see Figure 1)		1.17	1.76	ms
t_r	Output rise time			0.86	1.3	ms
t_f	Output fall time			1.37	2.06	ms
I_{OS}	Current limit threshold (Maximum DC current delivered to load) and short circuit current, SW_OUT connect to ground		$R_{SET} = 14.3\text{ k}\Omega$	1.65	1.76	1.87
		$R_{SET} = 20\text{ k}\Omega$	1.18	1.26	1.34	
		$R_{SET} = 50\text{ k}\Omega$		0.5		
		R_{SET} shorted to SW_IN or open	1.18	1.2	1.34	
T_{IOS}	Response time to short circuit	$V_{SW_INx} = 5\text{ V}$		2		μs

(1) Ensured by design.

Electrical Characteristics (continued)
 $T_J = 25^\circ\text{C}$, $V_{IN} = 24\text{ V}$, $f_{SW} = 500\text{ kHz}$, $R_{nFAULTx} = 100\text{ k}\Omega$ (unless otherwise noted)

PARAMETER		TEST CONDITIONS	MIN	TYP	MAX	UNIT
$T_{DEGLITCH(OCP)}$	Switch over current fault deglitch	Fault assertion or de-assertion due to over-current condition	7	10	13	ms
V_{L_nFAULT}	nFAULTx terminal output low voltage	$I_{nFAULTx} = 1\text{ mA}$			400	mV
V_{EN_SWH}	SW_EN1/2 high level input voltage	SW_EN1, SW_EN2	2			V
V_{EN_SWL}	SW_EN1/2 low level input voltage	SW_EN1, SW_EN2			0.4	V
R_{DIS}	Discharge resistance ⁽²⁾	$V_{SW_INx} = 5\text{ V}$, $V_{SW_ENx} = 0\text{ V}$		104		Ω
THERMAL SHUTDOWN						
T_{TRIP_BUCK}	Thermal protection trip point	Rising temperature		160		$^\circ\text{C}$
T_{HYST_BUCK}		Hysteresis		20		$^\circ\text{C}$
T_{TRIP_SW}	Power switch thermal protection trip point	Rising temperature		145		$^\circ\text{C}$
T_{HYST}		Hysteresis		20		$^\circ\text{C}$

- (2) The discharge function is active when the device is disabled (when enable is de-asserted). The discharge function offers a resistive discharge path for the external storage capacitor.

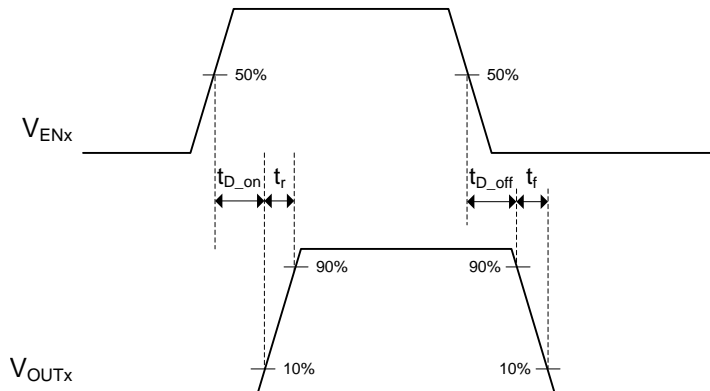

Figure 1. Power Switches Test Circuit and Voltage Waveforms

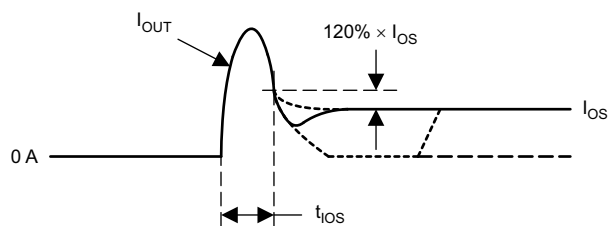

Figure 2. Response Time to Short Circuit Waveform

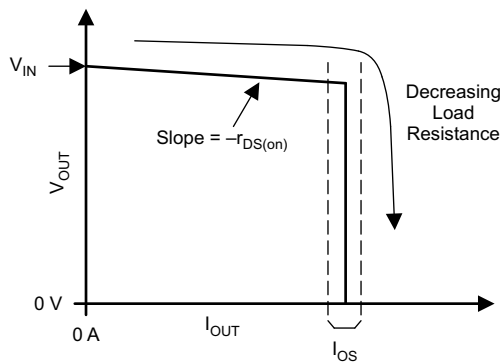

Figure 3. Output Voltage vs Current Limit Threshold

7.6 Typical Characteristics

$T_A = 25^\circ\text{C}$, $V_{IN} = 24\text{ V}$, $V_{OUT} = 5\text{ V}$, $f_{SW} = 500\text{ kHz}$, $R_{nFAULT} = 100\text{ k}\Omega$ (unless otherwise noted)

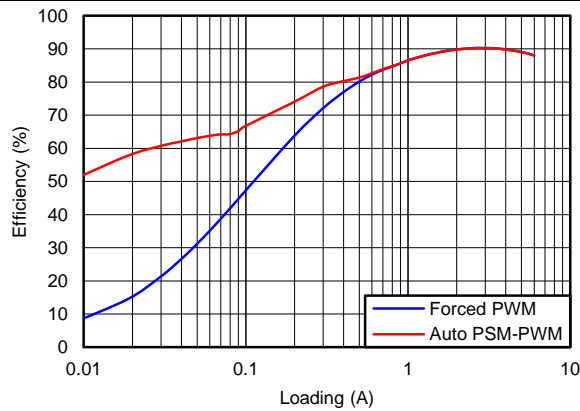

Figure 4. Buck Efficiency, $V_{OUT} = 5\text{ V}$

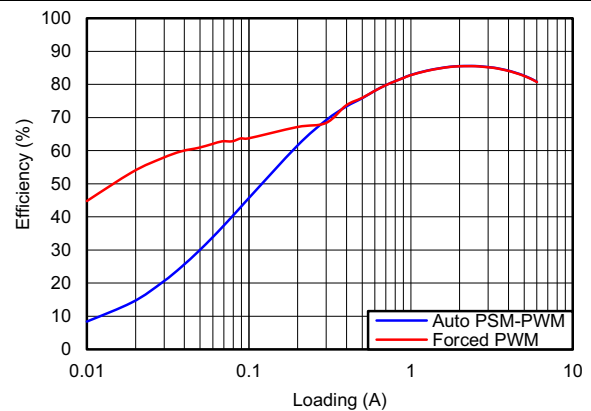

Figure 5. Buck Efficiency, $V_{OUT} = 2.5\text{ V}$

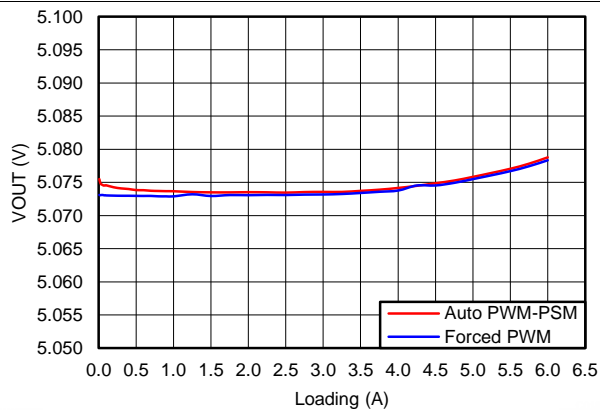

Figure 6. Buck Line Regulation, $V_{OUT} = 5\text{ V}$

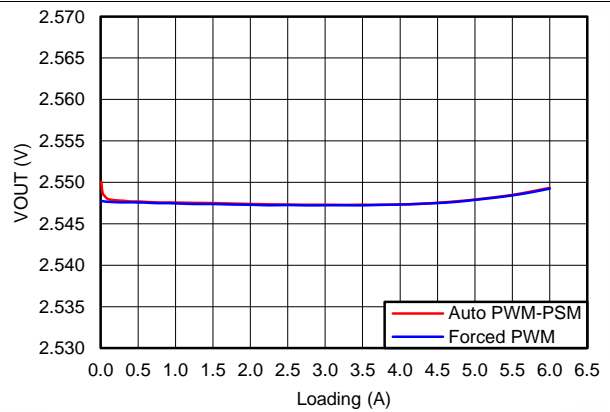

Figure 7. Buck Line Regulation, $V_{OUT} = 2.5\text{ V}$

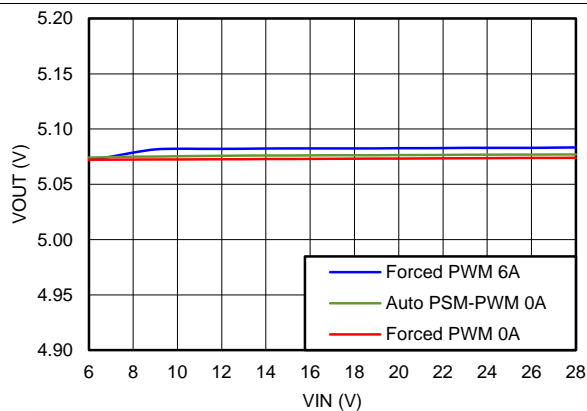

Figure 8. Buck Load Regulation, $V_{OUT} = 5\text{ V}$

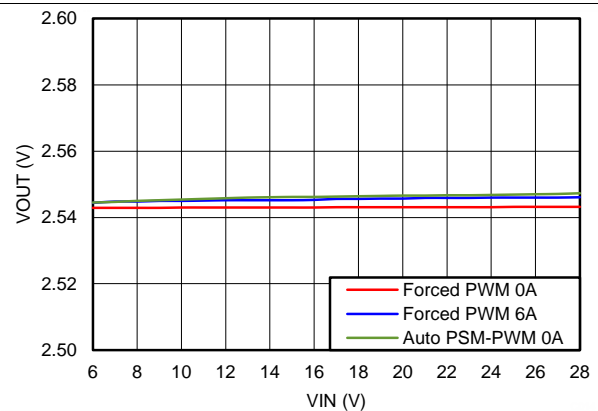

Figure 9. Buck Load Regulation, $V_{OUT} = 2.5\text{ V}$

Typical Characteristics (continued)

T_A = 25°C, V_{IN} = 24 V, V_{OUT} = 5 V, f_{SW} = 500 kHz, R_{nFAULT} = 100 kΩ (unless otherwise noted)

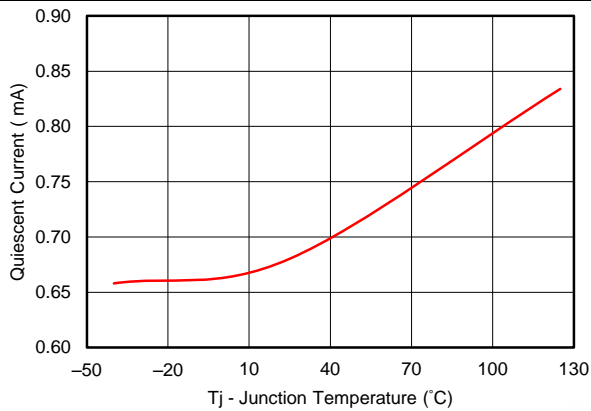

Figure 10. I_{IN} (Without Switching) vs Temperature

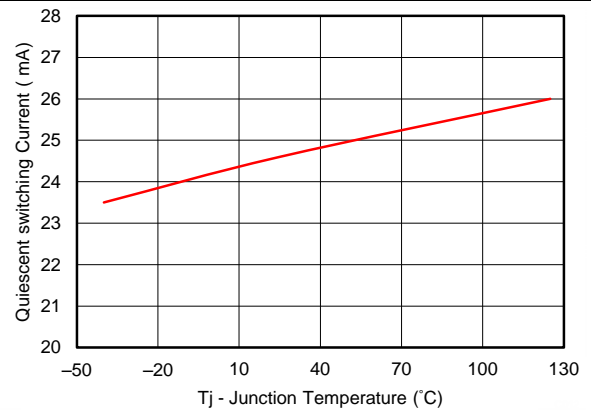

Figure 11. I_{IN} (With Buck Switching) vs Temperature

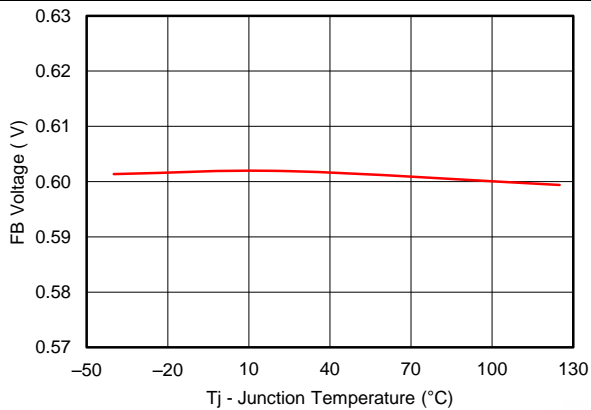

Figure 12. Reference Voltage vs Temperature

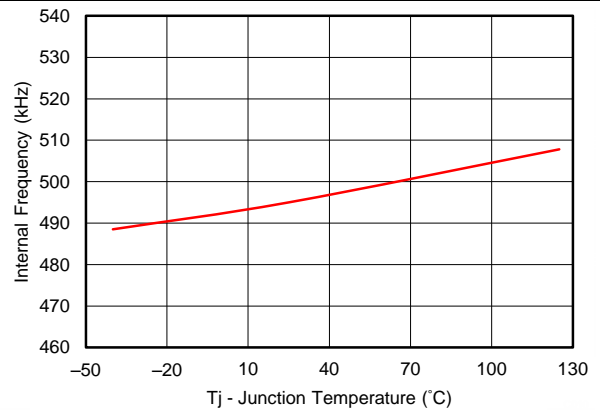

Figure 13. Oscillator Frequency vs Temperature

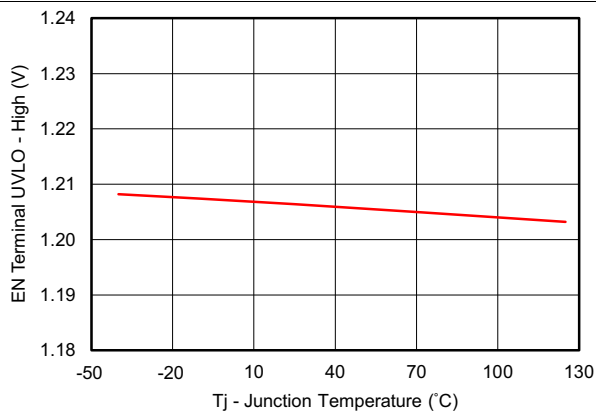

Figure 14. EN UVLO Start vs Temperature

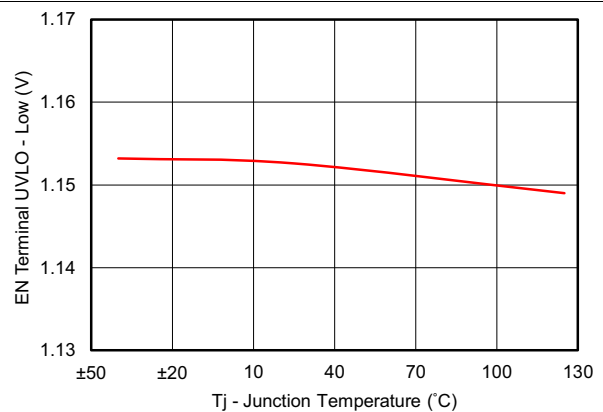

Figure 15. EN UVLO Stop vs Temperature

Typical Characteristics (continued)

$T_A = 25^\circ\text{C}$, $V_{IN} = 24\text{ V}$, $V_{OUT} = 5\text{ V}$, $f_{SW} = 500\text{ kHz}$, $R_{nFAULT} = 100\text{ k}\Omega$ (unless otherwise noted)

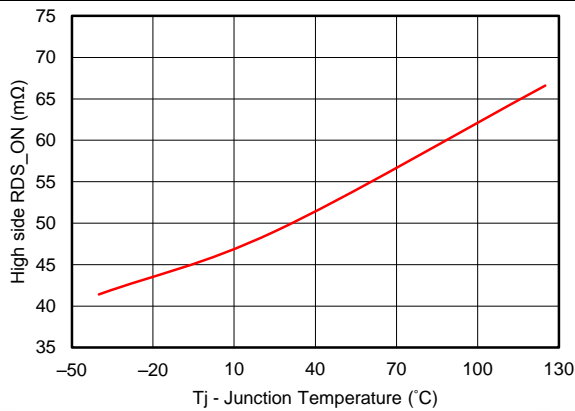

Figure 16. High-Side R_{DS_ON} vs Temperature

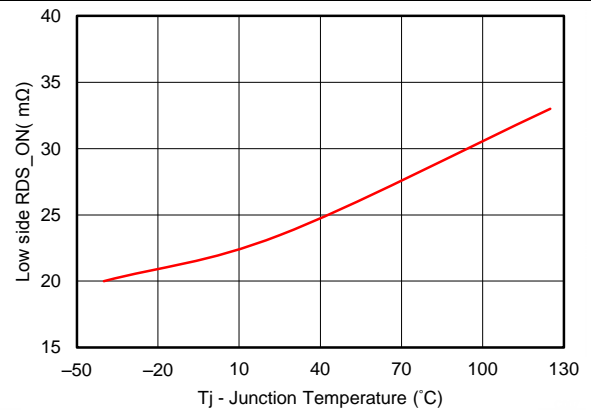

Figure 17. Low-Side R_{DS_ON} vs Temperature

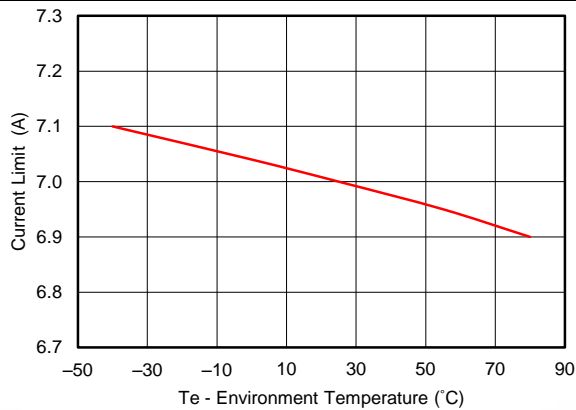

Figure 18. Buck DC Max I_{OUT} vs Temperature

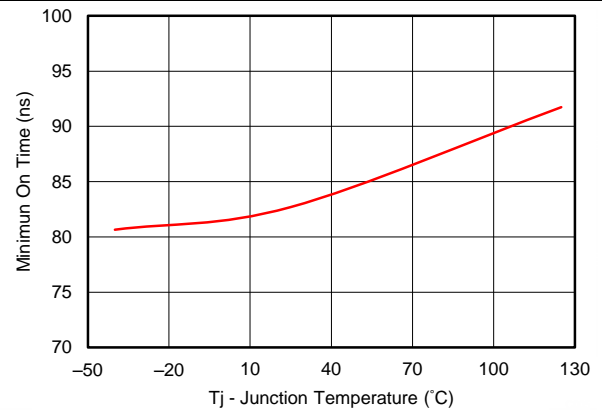

Figure 19. Minimum On Time vs Temperature

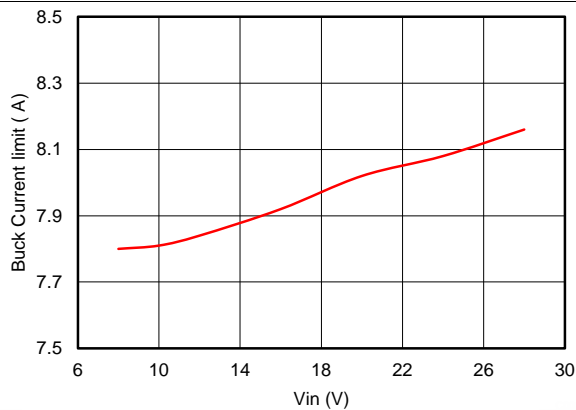

Figure 20. Buck Current Limit vs V_{IN}
(RLIMIT = 120 kΩ)

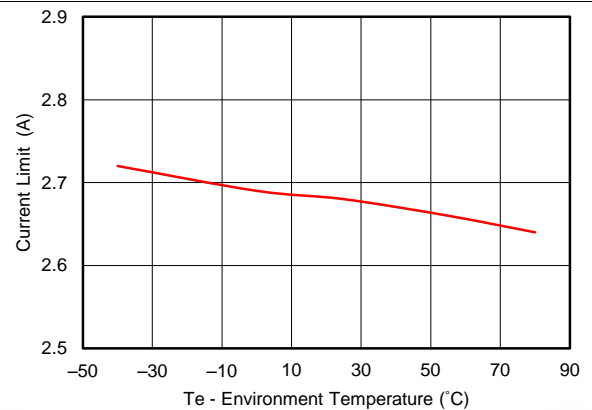

Figure 21. Power Switch Current Limit vs Temperature
(RSET = 9.1 kΩ)

8 Detailed Description

8.1 Overview

The TPS65286 PMIC integrates two independent current-limited, power distribution switches using N-channel MOSFETs for applications where short circuits or heavy capacitive loads will be encountered and provide precision current limit protection and fast protection response to over current. Additional device features include over temperature protection and reverse-voltage protection. The device incorporates an internal charge pump and gate driver circuitry necessary to drive the N-channel MOSFET. The charge pump supplies power to the driver circuit and provides the necessary voltage to pull the gate of the MOSFET above the source. The charge pump operates from the input voltage of power switches as low as 2.5 V. The driver incorporates circuitry that controls the rise and fall times of the output voltage to limit large current and voltage surges and provides built-in soft-start functionality. The TPS65286 device limits output current to a safe level when output load exceeds the current limit threshold. After deglitching time, the device latches off when the load exceeds the current limit threshold. The device asserts the nFAULT1/2 signal during over current or reverse voltage faulty condition.

The TPS65286 PMIC also integrates a synchronous step-down converter with regulated 0.6 V \pm 1% feedback reference voltage. The synchronous buck converter incorporates 55-m Ω high side power MOSFET and 30-m Ω low side power MOSFETs to achieve high efficiency power conversion. The converter supports an input voltage range from 4.5 V to 28 V. The converter operates in continuous conduction mode (CCM) with peak current mode control for simplified loop compensation. The peak inductor current limit threshold is adjustable to up to 8 A. The switching clock frequency is a fixed 500 kHz. The soft-start time can be adjusted by connecting an external capacitor at the SS terminal or fixed at 1 ms with the SS terminal open.

8.2 Functional Block Diagram

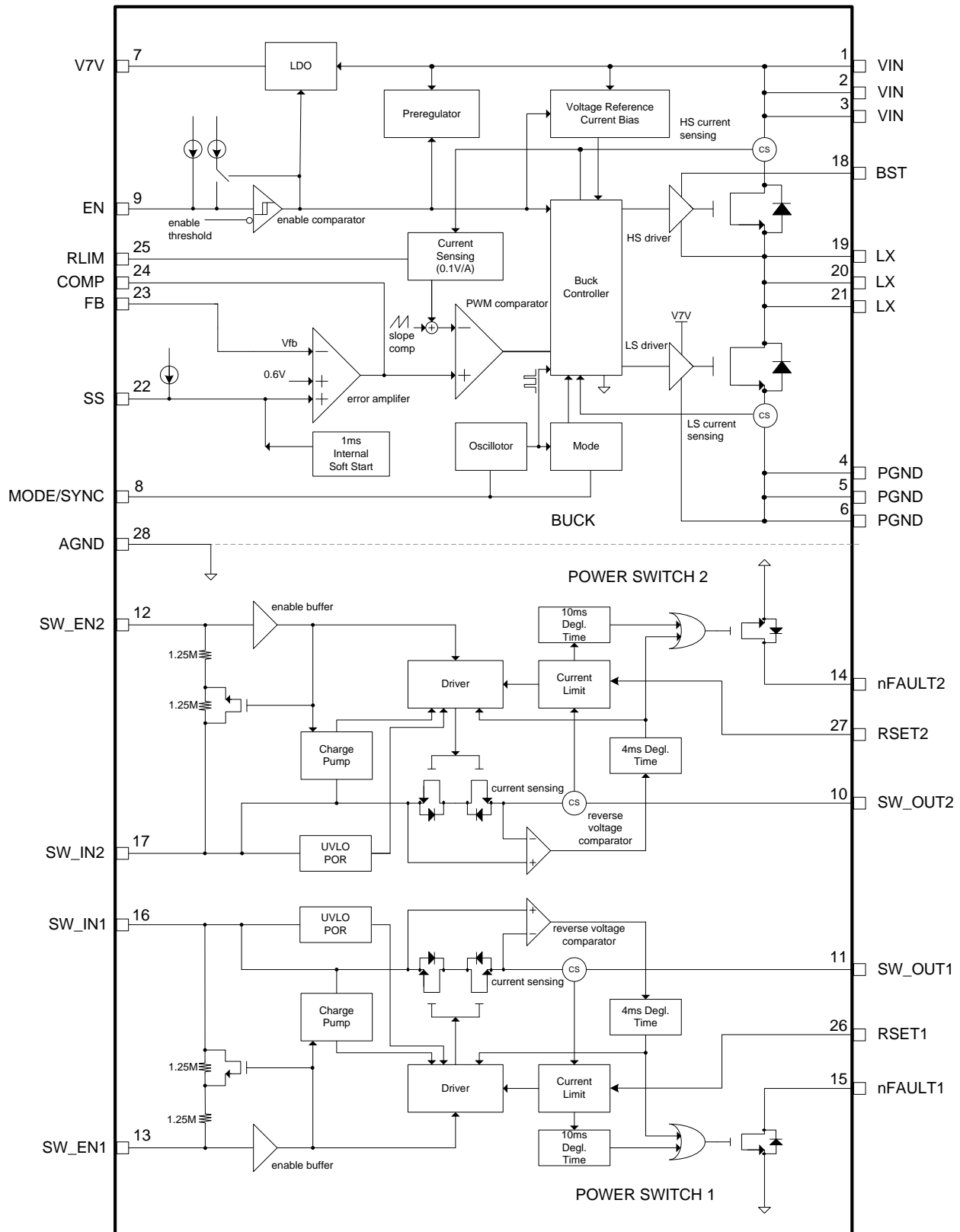

8.3 Feature Description

8.3.1 Power Switch

8.3.1.1 Over Current Condition

The TPS65286 responds to over-current conditions on power switches by limiting the output currents to the I_{OS} level, which is set by an external resistor. During normal operation the N-channel MOSFET is fully enhanced, and $V_{SW_OUT} = V_{SW_IN} - (I_{SW_OUT} \times R_{DSON_SW})$. The voltage drop across the MOSFET is relatively small compared to V_{SW_IN} , and $V_{SW_OUT} \approx V_{SW_IN}$. When an over current condition is detected, the device maintains a constant output current and reduces the output voltage accordingly. During current-limit operation, the N-channel MOSFET is no longer fully-enhanced and the resistance of the device increases. This allows the device to effectively regulate the current to the current-limit threshold. The effect of increasing the resistance of the MOSFET is that the voltage drop across the device is no longer negligible ($V_{SW_IN} \neq V_{SW_OUT}$) and V_{SW_OUT} decreases. The amount that V_{SW_OUT} decreases is proportional to the magnitude of the overload condition. The expected V_{SW_OUT} can be calculated by $I_{OS} \times R_{LOAD}$, where I_{OS} is the current-limit threshold and R_{LOAD} is the magnitude of the overload condition.

Three possible overload conditions can occur as summarized in [Table 1](#).

Table 1. Overload Conditions

CONDITIONS	BEHAVIORS
Short circuit or partial short circuit present when the device is powered up or enabled.	The output voltage is held near zero potential with respect to ground and the TPS65286 ramps output current to I_{OS} . The device limits the current to I_{OS} until the overload condition is removed or the internal deglitch time (10 ms typical) is reached and the device is turned off. The device will remain off until power is cycled or the device enable is toggled.
Gradually increasing load (< 100 A/s) from normal operating current to I_{OS} .	The current rises up to the current limit. Once the threshold has been reached, the device switches into its current limiting at I_{OS} . The device limits the current to I_{OS} until the overload condition is removed or the internal deglitch time (10 ms typical) is reached and the device is turned off. The device will remain off until power is cycled or the device enable is toggled.
Short circuit, partial short circuit or fast transient overload occurs while the device is enabled and powered on.	The device responds to the over-current condition within time t_{IOS} . The current sensing amplifier is overdriven during this time and needs time for loop response. Once t_{IOS} has passed, the current sensing amplifier recovers and limits the current to I_{OS} . The device limits the current to I_{OS} until the overload condition is removed or the internal deglitch time (10 ms typical) is reached and the device is turned off. The device will remain off until power is cycled or the device enable is toggled.

8.3.1.2 Reverse Current and Voltage Protection

A power switch in the TPS65286 incorporates dual back-to-back N-channel power MOSFETs so as to prevent the reverse current flowing back the input through body diode of MOSFET when the power switches are off.

The reverse-voltage protection turns off the N-channel MOSFETs whenever the output voltage exceeds the input voltage by 135 mV (typical) for 4 ms (typical). This prevents damaging devices by blocking significant current reverse injection into the input capacitance of power switch or buck output capacitance. The TPS65286 keeps the power switch turned off even if the reverse-voltage condition is removed and does not allow the N-channel MOSFET to turn on until power is cycled or the device enable is toggled. The reverse-voltage comparator also asserts the nFAULT1/2 output (active-low) after 4 ms.

8.3.1.3 nFAULT1/2 Response

The nFAULT1/nFAULT2 open-drain output is asserted (active low) during an over current, over temperature or reverse-voltage condition and remains asserted while the part is latched-off. The nFAULT signal is de-asserted once the device power is cycled or the enable is toggled and the device resumes normal operation. The TPS65286 is designed to eliminate false nFAULT reporting by using an internal delay deglitch circuit for over current (10 ms typical) and reverse-voltage (4 ms typical) conditions without the need for external circuitry. This ensures that nFAULT is not accidentally asserted due to normal operation such as starting into a heavy capacitive load. Deglitching circuitry delays entering and leaving fault conditions. Over temperature conditions are not deglitched and assert the FAULT signal immediately. [Figure 22](#) shows the over current operation of USB switch.

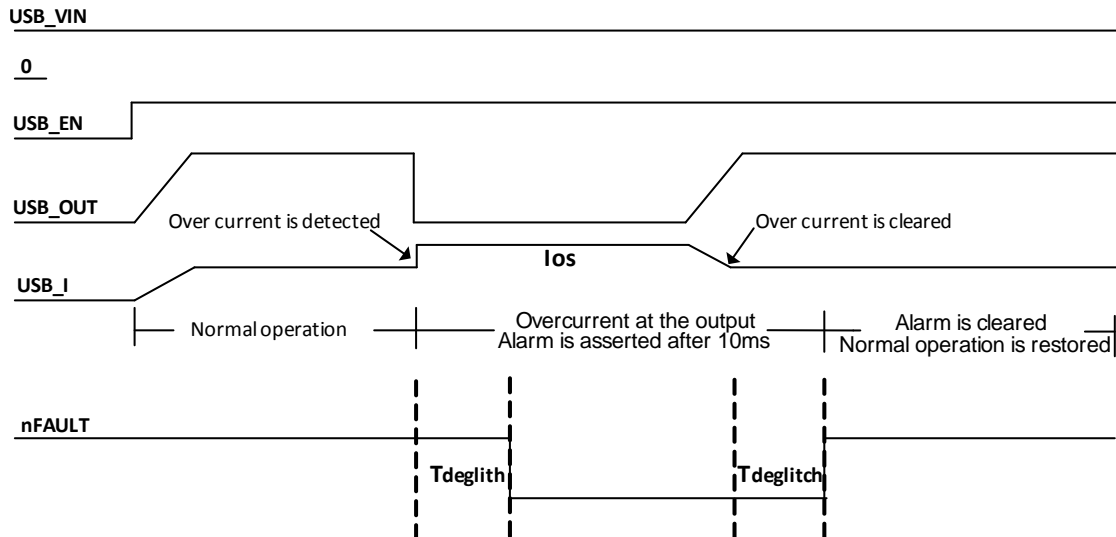

Figure 22. USB Switch Over Current Operation

8.3.1.4 Under-Voltage Lockout (UVLO)

The under-voltage lockout (UVLO) circuit disables the power switch until the input voltage reaches the UVLO turn-on threshold. Built-in hysteresis prevents unwanted on/off cycling due to input voltage drop from large current surges.

8.3.1.5 Enable and Output Discharge

The logic enable EN_SW1/EN_SW2 controls the power switch, bias for the charge pump, driver, and other circuits. The supply current from power switch driver is reduced to less than 1 μ A when a logic low is present on EN_SW1/2. A logic high input on EN_SW1/EN_SW2 enables the driver, control circuits, and power switch. The enable input is compatible with both TTL and CMOS logic levels.

When enable is de-asserted, the discharge function is active. The output capacitor of power switch is discharged through an internal NMOS with a 104- Ω resistance. The time taken for discharging is dependent on the RC time constant of the resistance and the output capacitor.

8.3.1.6 Power Switch Input and Output Capacitance

Input and output capacitors improve the performance of the device. The actual capacitance should be optimized for the particular application. The output capacitor in buck converter is recommended to place between SW_IN and AGND as close to the device as possible for local noise de-coupling. Additional capacitance may be needed on the input to reduce voltage overshoot from exceeding the absolute maximum voltage of the device during heavy transient conditions. This is especially important during bench testing when long, inductive cables are used to connect the input of power switches in the evaluation board to the bench power-supply. Placing a high-value electrolytic capacitor on the output terminal is recommended when large transient currents are expected on the output.

8.3.1.7 Programming the Current-Limit Threshold

The over-current threshold is user programmable via an external resistor. The TPS65286 uses an internal regulation loop to provide a regulated voltage reference on the RLIM terminal. The current-limit threshold is proportional to the current sourced out of the RSET terminal. A resistor with 1% accuracy is used between 10 k Ω \leq RSET \leq 232 k Ω to ensure stability of the internal regulation loop. [Equation 1](#) and [Figure 23](#) can be used to calculate current limiting threshold for a given external resistor value.

Current-limit threshold equation (I_{OS}):

$$I_{OS} = 27.465 \times (R_{SET})^{-1.04} \quad (1)$$

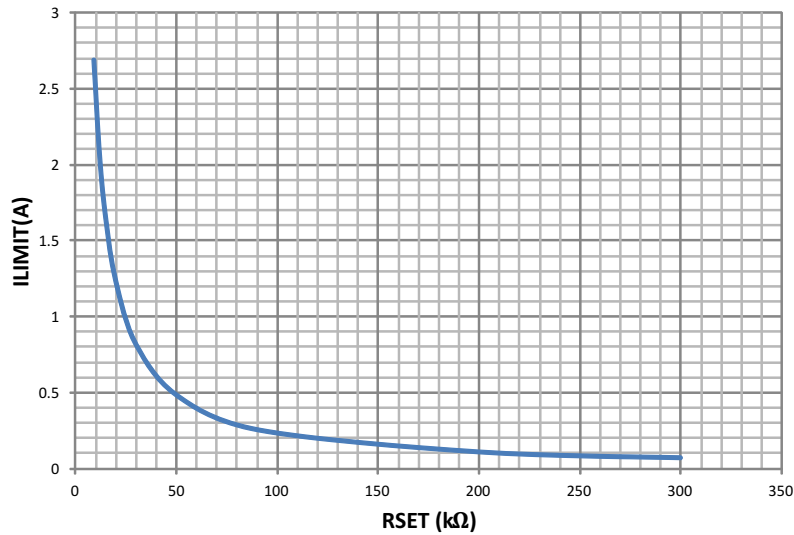

Figure 23. Current-Limit Threshold I_{OS} vs RLIM

8.3.2 Buck DCDC Converter

8.3.2.1 Output Voltage

The TPS65286 regulate output voltage set by a feedback resistor divider to 0.6-V reference voltage with feedback resistor divider. It is recommended to use 1% tolerance or better divider resistors. Great care should be taken to route the FB line away from noise sources, such as the inductor or the LX switching node line. Start with 39 kΩ for the R1 resistor and use Equation 2 to calculate R2.

$$R_2 = R_1 \cdot \left(\frac{0.6V}{V_{OUT} - 0.6V} \right) \tag{2}$$

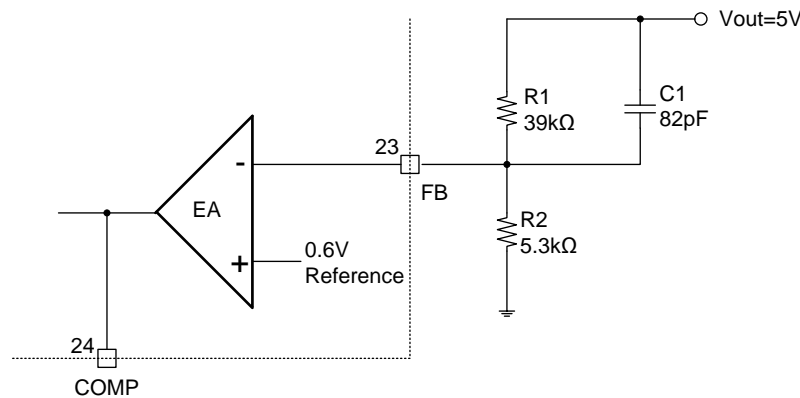

Figure 24. Buck Feedback Resistor Divider

8.3.2.2 Clock Synchronization

An internal phase locked loop (PLL) has been implemented to allow an external clock with frequency between 200 kHz and 1600 kHz to be synchronized to the internal clock. To implement the synchronization feature, connect a clock signal to the MODE/SYNC terminal with minimum pulse width larger than 80 ns and low/high voltage threshold at 0.4 V/2V. When an external clock is applied to MODE/SYNC terminal, the internal oscillator will force the rising edge of clock signal to be synchronized with the falling edge of the external clock.

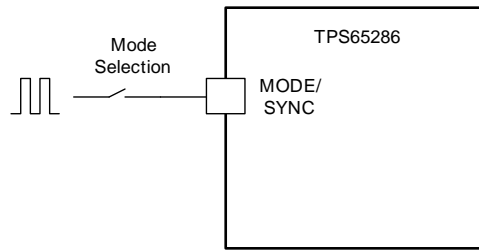

Figure 25. Clock Synchronization Mode

8.3.2.3 Error Amplifier

The device uses a transconductance error amplifier. The error amplifier compares the FB terminal voltage to the lower of the SS terminal voltage or the internal 0.6-V voltage reference. The transconductance of the error amplifier is 1300 $\mu\text{A/V}$ during normal operation. The frequency compensation network is connected between the COMP terminal and ground.

8.3.2.4 Slope Compensation

The device adds a compensating ramp to the switch current signal. This slope compensation prevents sub-harmonic oscillations. The slope rate of slope compensation remains constant over the full duty cycle range.

8.3.2.5 Enable and Adjusting Under-Voltage Lockout

The EN terminal provides electrical on/off control of the device. Once the EN terminal voltage exceeds the threshold voltage, the device starts operation. If the EN terminal voltage is pulled below the threshold voltage, the regulator stops switching and enters low I_q state. The EN terminal has an internal pull-up current source, allowing the user to float the EN terminal for enabling the device. If an application requires controlling the EN terminal, use open drain or open collector output logic to interface with the terminal. The device implements internal UVLO circuitry on the VIN terminal. The device is disabled when the VIN terminal voltage falls below the internal VIN UVLO threshold. The internal VIN UVLO threshold has a hysteresis of 150 mV. If an application requires either a higher UVLO threshold on the VIN terminal or a secondary UVLO on the PVIN in split rail applications, then the EN terminal can be configured as shown in Figure 26. When using the external UVLO function, it is recommended to set the hysteresis to be greater than 500 mV.

The EN terminal has an internal pull-up current source, allowing the user to float the EN terminal for enabling the device. If an application requires controlling the EN terminal, use open drain or open collector output logic to interface with the terminal. The pull-up current is also used to control the voltage hysteresis for the UVLO function since it increases by I_h once the EN terminal crosses the enable threshold. The UVLO thresholds can be calculated using Equation 3 and Equation 4.

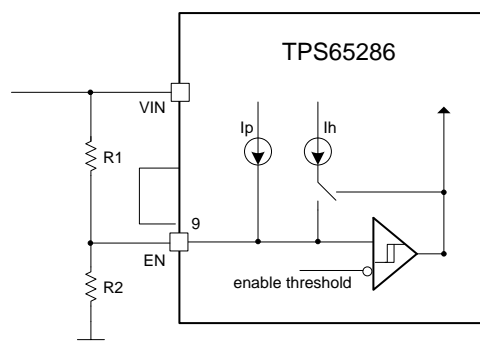

Figure 26. Adjustable VIN Under Voltage Lock Out

$$R_1 = \frac{V_{\text{START}} \left(\frac{V_{\text{ENFALLING}}}{V_{\text{ENRISING}}} \right) - V_{\text{STOP}}}{I_p \left(1 - \frac{V_{\text{ENFALLING}}}{V_{\text{ENRISING}}} \right) + I_h} \quad (3)$$

$$R_2 = \frac{R_1 \times V_{\text{ENFALLING}}}{V_{\text{STOP}} - V_{\text{ENFALLING}} + R_1(I_h + I_p)} \quad (4)$$

Where $I_h = 1 \mu\text{A}$, $I_p = 2 \mu\text{A}$, $V_{\text{ENRISING}} = 1.21 \text{ V}$, and $V_{\text{ENFALLING}} = 1.17 \text{ V}$.

8.3.2.6 Soft-Start Time

During startup, the output voltage follows up the voltage at the SS terminal to prevent inrush current. When the SS terminal voltage is less than the internal 0.6-V reference, the TPS65286 regulates the feedback voltage to the SS terminal voltage. The SS terminal can be used to program an external soft-start function or to allow output of the buck to track another supply during start-up. An internal pull-up current source of $5.5 \mu\text{A}$ charges an external soft-start capacitor to provide a ramping voltage at SS terminal. The TPS65286 will regulate the feedback voltage to the SS terminal voltage and VOUT rises smoothly from 0 V to its final regulated voltage. The soft-start time can be calculated by [Equation 5](#):

$$T_{\text{ss}}(\text{ms}) = \frac{C_{\text{ss}}(\text{nF}) \times V_{\text{ref}}(\text{V})}{I_{\text{ss}}(\mu\text{A})} \quad (5)$$

With a floating SS terminal, there is default 1-ms (typical) soft-start time built in the chip.

8.3.2.7 Internal V7V Regulator

The TPS65286 features an internal low dropout linear regulator (LDO) from VIN to V7V. The LDO regulates V7V to 6.3-V over drive voltage on power MOSFET for the best efficiency performance. The LDO also provides supply bias for internal analog controller and power for low-side MOSFET for the best efficiency performance. The current limit of LDO is 50 mA and connecting a minimum 1- μF ceramic capacitor to the V7V terminal is recommended. Directly placing the capacitor close to the V7V and PGND terminals is highly recommended for high transient current required by the MOSFET gate drivers.

8.3.2.8 Hard Short Circuit Protection

The peak inductor current limit trip of buck converter is set by an external resistor at the RLIM terminal. The peak inductor current threshold for over current protection can be calculated by [Equation 6](#).

$$I_{LIMIT} = 926.78 \times (R_{LIM})^{-0.979} \quad (6)$$

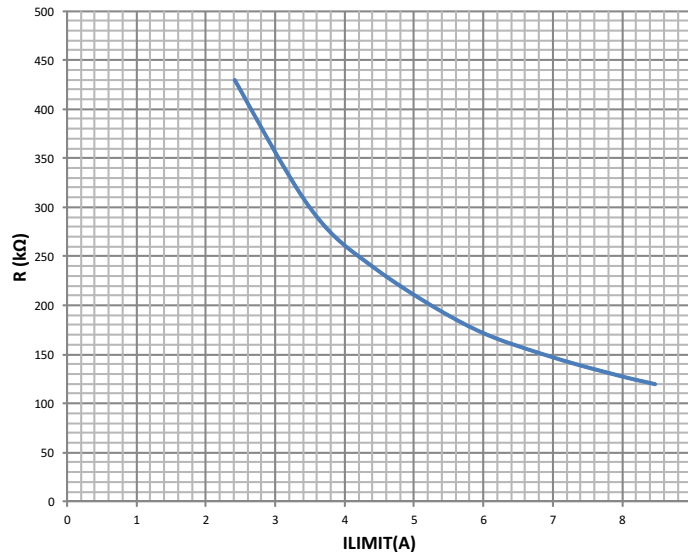

Figure 27. Current-Limit Threshold vs RLIM

The device is protected from over current conditions by cycle-by-cycle current limiting on both the high-side MOSFET and the low-side MOSFET.

High-side MOSFET over current protection:

The device implements current mode control which uses the COMP terminal voltage to control the turn off of the high-side MOSFET and the turn on of the low-side MOSFET on a cycle-by-cycle basis. Each cycle the switch current and the current reference generated by the COMP terminal voltage are compared, the peak switch current intersects the current reference and the high-side switch is turned off.

Low-side MOSFET over current protection:

While the low-side MOSFET is turned on, its conduction current is monitored by the internal circuitry. During normal operation, the low-side MOSFET sources current to the load. At the end of every clock cycle, the low-side MOSFET sourcing current is compared to the internally sourcing current limit threshold. If the low-side sourcing current is exceeded, the high-side MOSFET is turned off and the low-side MOSFET is forced on for the next cycle. The high-side MOSFET is turned on again when the low-side current is below the low-side sourcing current limit threshold at the start of a cycle.

The low-side MOSFET may also sink current from the load. If the low-side sinking current limit is exceeded, the low-side MOSFET is turned off immediately for the rest of that clock cycle. In this scenario both MOSFETs are off until the next cycle. Furthermore, if an output overload condition (as measured by the COMP terminal voltage) has lasted for more than the hiccup wait time which is programmed for 256 switching cycles, the device will shut down and recover after the hiccup time of 8192 cycles. The hiccup mode helps to reduce the device power dissipation under over current conditions.

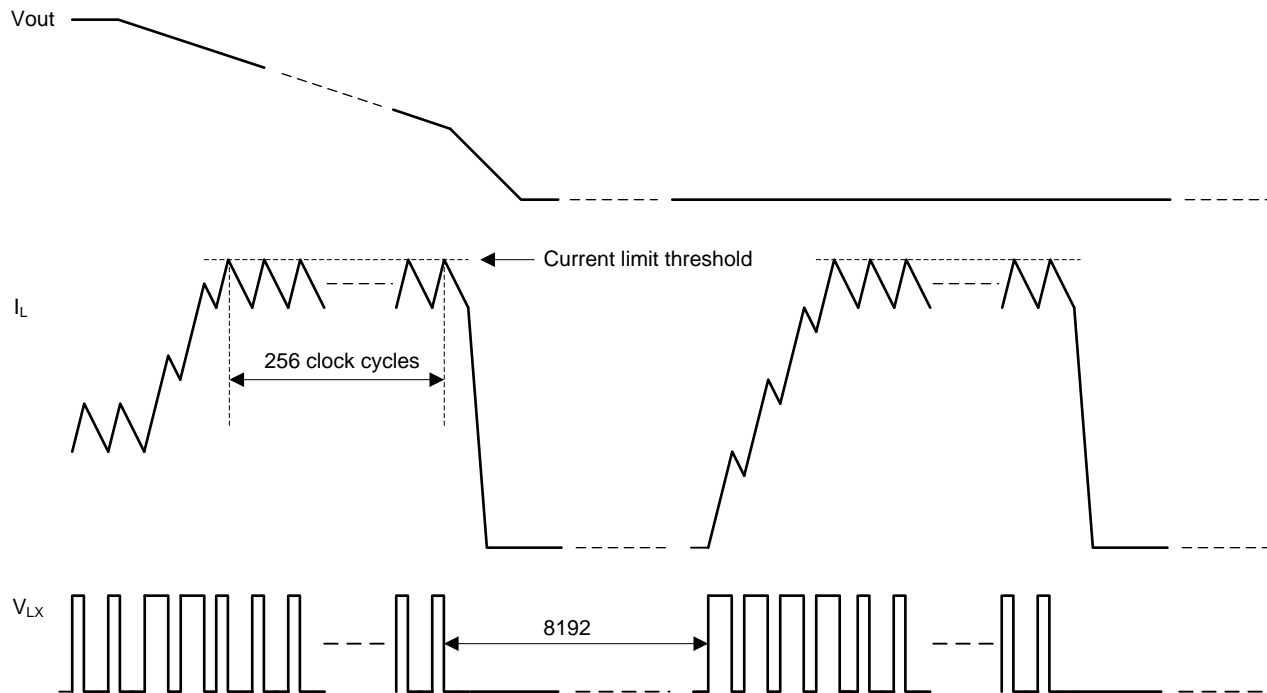

Figure 28. DCDC Over-Current Protection

8.3.2.9 Bootstrap Voltage (BST) and Low Dropout Operation

The device has an integrated bootstrap regulator and requires a small ceramic capacitor between the BST and LX terminals to provide the gate drive voltage for the high-side MOSFET. The bootstrap capacitor is charged when the BST terminal voltage is less than VIN and BST-LX voltage is below regulation. The value of this ceramic capacitor is recommended 0.047 μ F or less. A ceramic capacitor with an X7R or X5R grade dielectric with a voltage rating of 10 V or higher is recommended because of the stable characteristics over temperature and voltage.

To improve drop out, the device is designed to operate at 100% duty cycle as long as the BST to LX terminal voltage is greater than the BST-LX UVLO threshold which is typically 2.1 V. When the voltage between BST and LX drops below the BST-LX UVLO threshold the high-side MOSFET is turned off and the low-side MOSFET is turned on allowing the boot capacitor to be recharged.

8.3.2.10 Thermal Performance

The device implements an internal thermal overloading sensor to protect the chip with stopping buck converter switching if the junction temperature exceeds 160°C. Once the die temperature decreases below 140°C, the device automatically reinitiates the power up sequence.

8.3.2.11 Loop Compensation

The integrated buck DCDC converter in TPS65286 incorporates a peak current mode. The error amplifier is a trans-conductance amplifier with a gain of 1000 $\mu\text{A/V}$. A typical type II compensation circuit adequately delivers a phase margin between 60° and 90°. C_b adds a high frequency pole to attenuate high frequency noise when needed. To calculate the external compensation components, follow these steps:

1. Select switching frequency, f_{SW} , that is appropriate for application depending on L and C sizes, output ripple, and EMI. Switching frequency between 500 kHz to 1 MHz gives the best trade off between performance and cost. To optimize efficiency, lower switching frequency is desired.
2. Set up cross over frequency, f_c , which is typically between 1/5 and 1/20 of f_{SW} .
3. R_C can be determined by:

$$R_C = \frac{2\pi \cdot f_c \cdot V_o \cdot C_o}{g_M \cdot V_{\text{ref}} \cdot g_{\text{mps}}} \quad (7)$$

where g_M is the error amplifier gain (1000 $\mu\text{A/V}$), g_{mps} is the power stage voltage to current conversion gain (10 A/V).

4. Calculate C_C by placing a compensation zero at or before the dominant pole ($f_p = 1 / C_o \times R_L \times 2\pi$).

$$C_C = \frac{R_L \cdot C_o}{R_C} \quad (8)$$

5. Optional C_b can be used to cancel the zero from the ESR associated with C_o .

$$C_b = \frac{\text{Resr} \cdot C_o}{R_C} \quad (9)$$

6. Type III compensation can be implemented with the addition of one capacitor, C_1 . This allows for slightly higher loop bandwidths and higher phase margins. If used, C_1 is calculated from [Equation 10](#).

$$C_1 = \frac{1}{2\pi \cdot R_1 \cdot f_c} \quad (10)$$

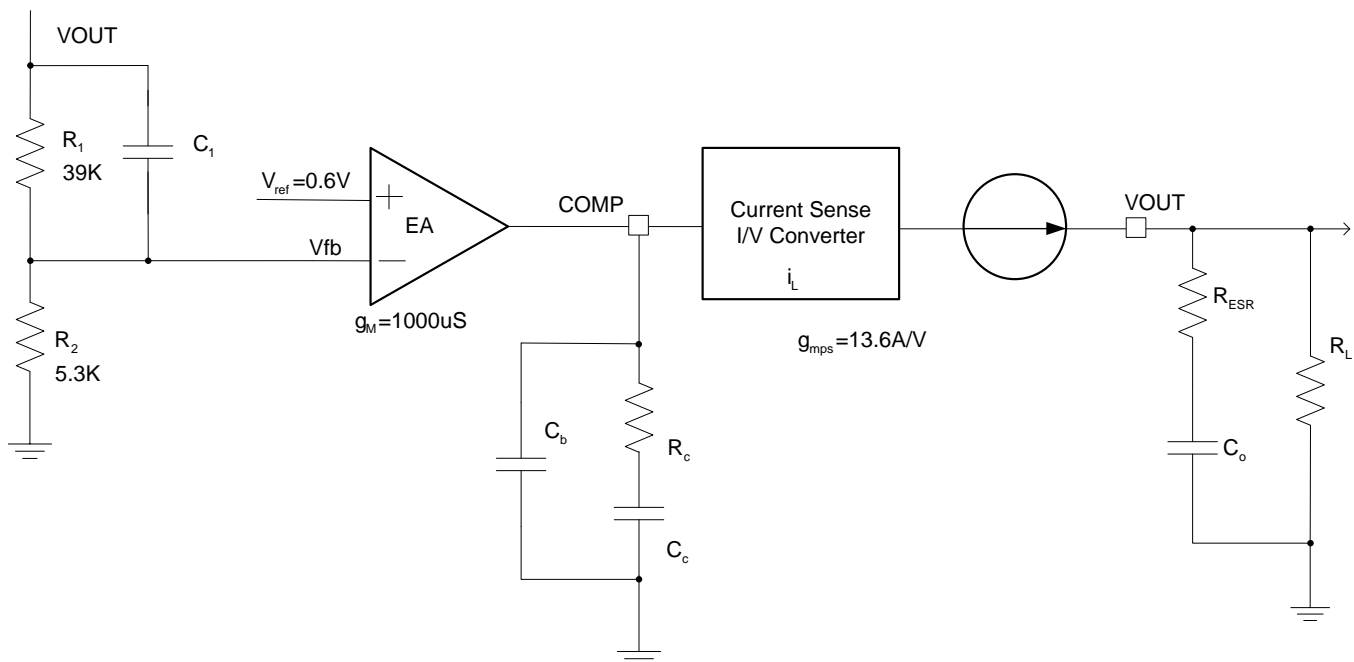

Figure 29. DCDC Loop Compensation

8.4 Device Functional Modes

8.4.1 Pulse Skipping Mode Operation

When a synchronous buck converter operates at light load condition, TPS65286 operates with pulse skipping mode (PSM) to reduce the switching loss by keeping the power transistors in the off-state for several switching cycles, while maintaining a regulated output voltage. The output voltage, load and inductor current diagrams are shown in [Figure 30](#). When the VCOMP falls lower than VGS, the COMP terminal voltage is clamped to VGS internally, typical 350 mV, the device enters pulse skipping mode and high side MOSFET stops switching, then the output falls and the VCOMP rises. When the VCOMP rises larger than VGS, the high side MOSFET starts switching, then the output rises and the VCOMP falls. When the VCOMP falls lower than VGS, the high side MOSFET stops switching again. If the peak inductor current rise above typical 600 mA ($V_{IN} = 24\text{ V}$, $V_{OUT} = 5\text{ V}$) and the COMP terminal voltage to rise above VGS, the converter exits pulse skipping mode. Since converter detects the peak inductor current for pulse skip mode, the average load current entering pulse skipping mode varies with the applications and external output filters.

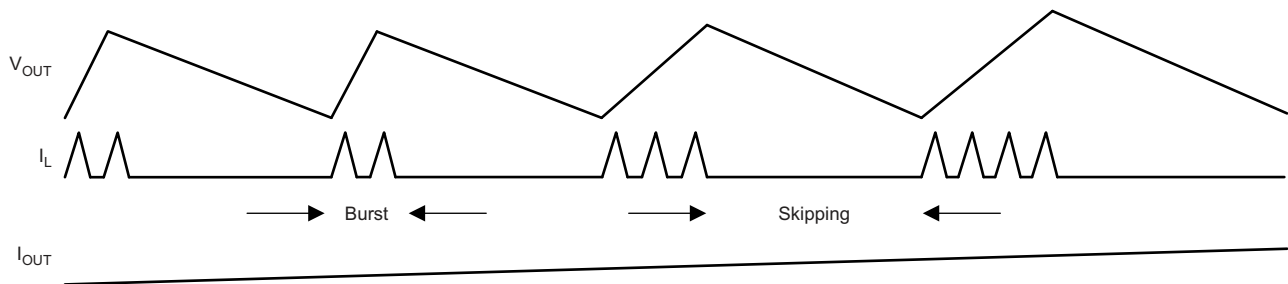

Figure 30. Pulse Skipping Mode

9 Application and Implementation

9.1 Application Information

The TPS65286 is a step down dc/dc converter. It is typically used to convert a higher dc voltage to a lower dc voltage with a maximum available output current of 6 A. The following design procedure can be used to select component values for the TPS65286.

Alternately, the WEBENCH® software may be used to generate a complete design. The WEBENCH software uses an iterative design procedure and accesses a comprehensive database of components when generating a design. This section presents a simplified discussion of the design process.

9.2 Typical Applications

The application schematic of [Figure 31](#) was developed to meet the requirements above. This circuit is available as the TPS65286EVM evaluation module. The design procedure is given in this section.

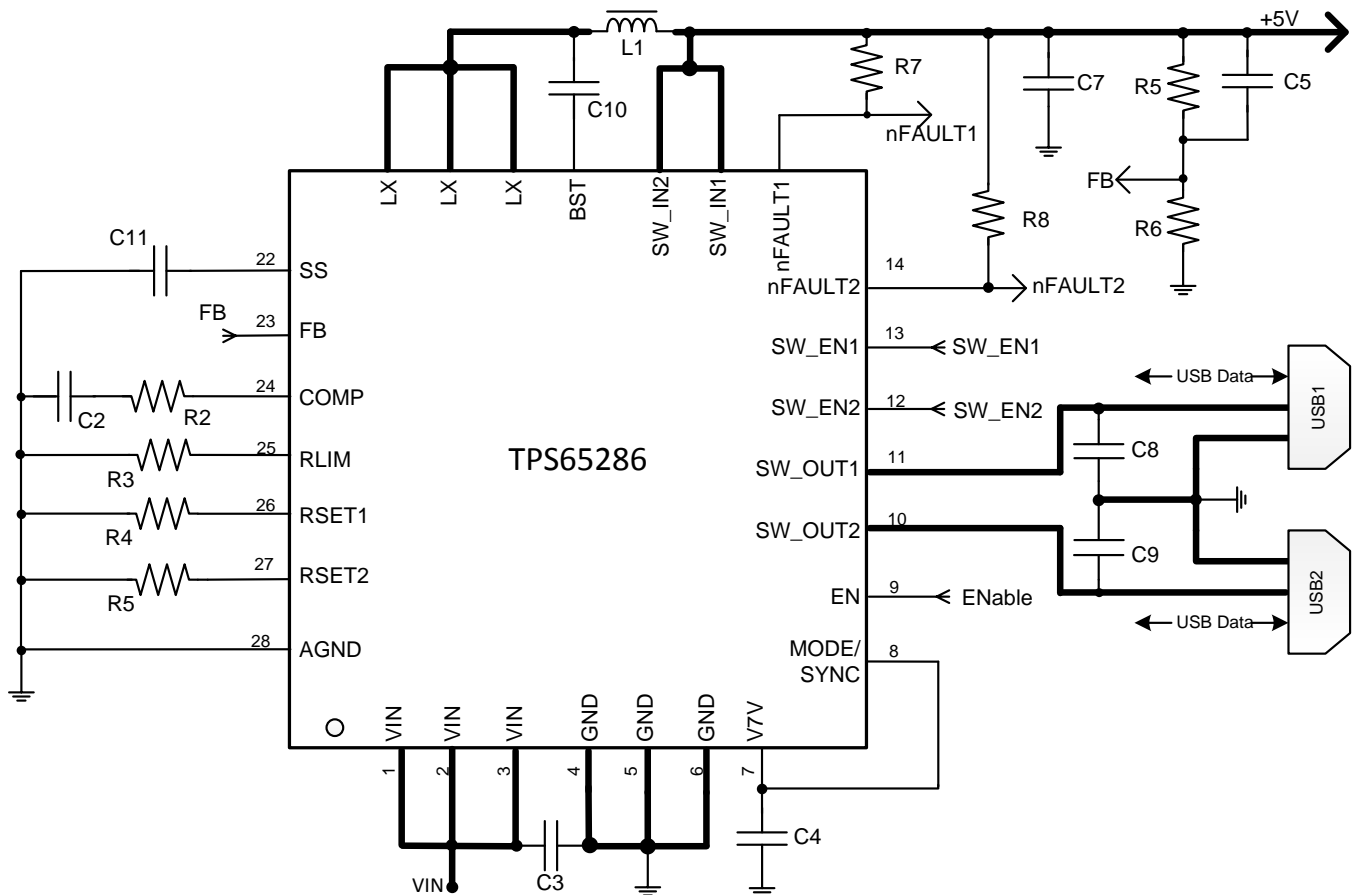

Figure 31. Typical Application Schematic

Typical Applications (continued)

9.2.1 Design Requirements

For this design example, use the following as the input parameters.

Table 2. Design Parameters

DESIGN PARAMETER	EXAMPLE VALUE
Input voltage range	4.5 V - 28 V
Output voltage	5 V
Transient response, 1.5-A load step	$\Delta V_{OUT} = \pm 5\%$
Input ripple voltage	400 mV
Output ripple voltage	30 mV
Output current rating	6 A
Operating frequency	500 kHz

9.2.2 Detailed Design Procedure

9.2.2.1 Step by Step Design Procedure

To begin the design process a few parameters must be decided upon. The designer needs to know the following:

- Input voltage range
- Output voltage
- Input ripple voltage
- Output ripple voltage
- Output current rating
- Operating frequency

9.2.2.2 Related Parts

PART NO.	DESCRIPTION	COMMENTS
TPS65280	One buck converter and two USB switches	$0.3 \leq f_{SW} \leq 1.4$ MHz, $4.5 \text{ V} \leq V_{IN} \leq 18 \text{ V}$, V_{OUT} fixed 5 V, maximum DC current 4 A, $2.5 \text{ V} \leq V_{SW_IN} \leq 6 \text{ V}$, USB current limit fixed 1.2 A, with manufacture trim option.
TPS65281, TPS65281-1	One buck converter and one USB switch	$0.3 \leq f_{SW} \leq 1.4$ MHz, $4.5 \text{ V} \leq V_{IN} \leq 18 \text{ V}$, V_{OUT} adjustable, maximum DC current 4 A, $2.5 \text{ V} \leq V_{SW_IN} \leq 6 \text{ V}$, USB current limit adjustable form 75 mA to 2.7 A.
TPS65282	One buck converter and two USB switches	$0.3 \leq f_{SW} \leq 1.4$ MHz, $4.5 \text{ V} \leq V_{IN} \leq 18 \text{ V}$, V_{OUT} adjustable, maximum DC current 4 A, $2.5 \text{ V} \leq V_{SW_IN} \leq 6 \text{ V}$, USB current limit adjustable form 75 mA to 2.7 A.
TPS65287	Three buck converters and one USB switch	$0.3 \leq f_{SW} \leq 2.2$ MHz, $4.5 \text{ V} \leq V_{IN} \leq 18 \text{ V}$, V_{OUT} adjustable, maximum DC current 3/2/2 A, $2.5 \text{ V} \leq V_{SW_IN} \leq 6 \text{ V}$, USB current limit adjustable form 75 mA to 2.7 A.
TPS65288	Three buck converters and two USB switches	$0.3 \leq f_{SW} \leq 2.2$ MHz, $4.5 \text{ V} \leq V_{IN} \leq 18 \text{ V}$, V_{OUT} adjustable, maximum DC current 3/2/2 A, $2.5 \text{ V} \leq V_{SW_IN} \leq 6 \text{ V}$, USB current limit fixed 1.2 A, with manufacture trim option.

9.2.2.3 Inductor Selection

The higher operating frequency allows the use of smaller inductor and capacitor values. A higher frequency generally results in lower efficiency because of MOSFET gate charge losses. In addition to this basic trade-off, the effect of inductor value on ripple current and low current operation must also be considered. The ripple current depends on the inductor value. The inductor ripple current i_L decreases with higher inductance or higher frequency and increases with higher input voltage V_{IN} . Accepting larger values of i_L allows the use of low inductances, but results in higher output voltage ripple and greater core losses.

To calculate the value of the output inductor, use [Equation 11](#). LIR is a coefficient that represents inductor peak-to-peak ripple to DC load current. LIR is suggested to choose to 0.1 ~ 0.3 for most applications.

Actual core loss of inductor is independent of core size for a fixed inductor value, but it is very dependent on inductance value selected. As inductance increases, core losses go down. Unfortunately, increased inductance requires more turns of wire and therefore copper losses will increase. Ferrite designs have very low core loss and are preferred for high switching frequencies, so design goals can concentrate on copper loss and preventing saturation. Ferrite core material saturates hard, which means that inductance collapses abruptly when the peak design current is exceeded. It results in an abrupt increase in inductor ripple current and consequent output voltage ripple. Do not allow the core to saturate. It is important that the RMS current and saturation current ratings are not exceeding the inductor specification. The RMS and peak inductor current can be calculated from [Equation 13](#) and [Equation 14](#).

$$L = \frac{V_{in} - V_{out}}{I_O \cdot LIR} \cdot \frac{V_{out}}{V_{in} \cdot f_{sw}} \quad (11)$$

$$\Delta i_L = \frac{V_{in} - V_{out}}{L} \cdot \frac{V_{out}}{V_{in} \cdot f_{sw}} \quad (12)$$

$$i_{Lrms} = \sqrt{I_O^2 + \frac{(V_{out} \cdot (V_{inmax} - V_{out}))^2}{V_{inmax} \cdot L \cdot f_{sw}}} \quad (13)$$

$$I_{Lpeak} = I_O + \frac{\Delta i_L}{2} \quad (14)$$

For this design example, use LIR = 0.3 and the inductor is calculated to be 4.40 μ H with $V_{IN} = 24$ V. Choose 4.7 μ H value of the standard inductor, the peak to peak inductor ripple is about 28.1% of 6-A DC load current.

9.2.2.4 Output Capacitor Selection

There are two primary considerations for selecting the value of the output capacitor. The output capacitors are selected to meet load transient and output ripple's requirements. [Equation 15](#) gives the minimum output capacitance to meet the transient specification. For this example, $L_O = 4.7$ μ H, $\Delta I_{OUT} = 3$ A – 0 A = 3 A and $\Delta V_{OUT} = 250$ mV (5% of regulated 5 V). Using these numbers gives a minimum capacitance of 34 μ F. A standard 4 x 22 μ F ceramic is chose in the design.

$$C_O > \frac{\Delta I_{OUT}^2 \cdot L}{V_{out} \cdot \Delta V_{out}} \quad (15)$$

The selection of C_{OUT} is driven by the effective series resistance (ESR). [Equation 16](#) calculates the minimum output capacitance needed to meet the output voltage ripple specification. Where f_{SW} is the switching frequency, ΔV_{OUT} is the maximum allowable output voltage ripple, and Δi_L is the inductor ripple current. In this case, the maximum output voltage ripple is 40 mV (1% of regulated 5 V). From [Equation 16](#), the output current ripple is 1.7 A and the minimum output capacitance meeting the output voltage ripple requirement is 12.2 μ F with 3-m Ω ESR resistance.

$$C_O > \frac{1}{8 \cdot f_{sw}} \cdot \frac{1}{\frac{\Delta V_{out}}{\Delta i_L} - esr} \quad (16)$$

After considering both requirements, for this example, four 22- μ F 6.3-V X7R ceramic capacitors with 3-m Ω of ESR will be used. [Equation 17](#) calculates the maximum ESR an output capacitor can have to meet the output voltage ripple specification. [Equation 17](#) indicates the ESR should be less than 23.5 m Ω . In this case, the ceramic capacitors' ESR is much smaller than 23.5 m Ω .

$$\frac{V_{ripple}}{I_{ripple}} \leq Resr \quad (17)$$

Additional capacitance de-ratings for aging, temperature and DC bias should be factored in which increases this minimum value. For this example, a 47- μ F 6.3-V X5R ceramic capacitor with 3-m Ω of ESR is be used. Capacitors generally have limits to the amount of ripple current they can handle without failing or producing excess heat. An output capacitor that can support the inductor ripple current must be specified. Some capacitor data sheets specify the root mean square (RMS) value of the maximum ripple current. [Equation 18](#) can be used to calculate the RMS ripple current the output capacitor needs to support. For this application, [Equation 18](#) yields 486 mA.

$$I_{\text{corms}} = \frac{V_{\text{out}} \cdot (V_{\text{inmax}} - V_{\text{out}})}{\sqrt{12} \cdot V_{\text{inmax}} \cdot L1 \cdot f_{\text{sw}}} \quad (18)$$

9.2.2.5 Input Capacitor Selection

A minimum 10- μF X7R/X5R ceramic input capacitor is recommended to be added between VIN and GND. These capacitors should be connected as close as physically possible to the input terminals of the converters as they handle the RMS ripple current shown in Equation 19. For this example, $I_{\text{out}} = 6 \text{ A}$, $V_{\text{out}} = 5 \text{ V}$, minimum $V_{\text{in_min}} = 24 \text{ V}$. The input capacitors must support a ripple current of 2.4-A RMS.

$$I_{\text{inrms}} = I_{\text{out}} \cdot \sqrt{\frac{V_{\text{out}}}{V_{\text{inmin}}} \cdot \frac{(V_{\text{inmin}} - V_{\text{out}})}{V_{\text{inmin}}}} \quad (19)$$

The input capacitance value determines the input ripple voltage of the regulator. The input voltage ripple can be calculated using Equation 20. Using the design example values, $I_{\text{out_max}} = 6 \text{ A}$, $C_{\text{in}} = 22 \mu\text{F}$, $f_{\text{sw}} = 500 \text{ kHz}$, yields an input voltage ripple of 136 mV.

$$\Delta V_{\text{in}} = \frac{I_{\text{outmax}} \cdot 0.25}{C_{\text{in}} \cdot f_{\text{sw}}} \quad (20)$$

To prevent large voltage transients, a low ESR capacitor sized for the maximum RMS current must be used.

9.2.2.6 Soft-Start Capacitor Selection

The slow start capacitor determines the minimum amount of time it takes for the output voltage to reach its nominal programmed value during power up. This is useful if a load requires a controlled voltage slew rate. This is also used if the output capacitance is very large and would require large amounts of current to quickly charge the capacitor to the output voltage level. The large currents necessary to charge the capacitor may make the TPS65286 reach the current limit or excessive current draw from the input power supply may cause the input voltage rail to sag. Limiting the output voltage slew rate solves both of these problems. The soft-start capacitor value can be calculated using . The soft-start circuit requires 1 nF per around 0.109 ms to be connected at the SS terminal. For the example circuit, the output capacitor value is 47 nF and the soft-start time is 5.1 ms. In TPS65286, I_{ss} is 5.5 μA and V_{ref} is 0.6 V.

$$T_{\text{ss}} = C_{\text{ss}} \cdot \left(\frac{0.6\text{V}}{5.5\mu\text{A}} \right) \quad (21)$$

9.2.2.7 Minimum Output Voltage

Due to the internal design of the TPS65286, there is a minimum output voltage limit for any given input voltage. The output voltage can never be lower than the internal voltage reference of 0.6 V. Above 0.6 V, the output voltage may be limited by the minimum controllable on time. The minimum output voltage in this case is given by Equation 22.

$$V_{\text{outmin}} = \text{Ontime}_{\text{min}} \cdot F_{\text{smax}}(V_{\text{inmax}} + I_{\text{outmin}}(\text{RDS2min} - \text{RDS1min})) - I_{\text{outmin}}(\text{RL} + \text{RDS2min})$$

where

- V_{outmin} = minimum achievable output voltage
- $\text{Ontime}_{\text{min}}$ = minimum controllable on-time (120 ns maximum)
- F_{smax} = maximum switching frequency including tolerance
- V_{inmax} = maximum input voltage
- I_{outmin} = minimum load current
- RDS1min = minimum high side MOSFET on resistance (52 m Ω typical)
- RDS2min = minimum low side MOSFET on resistance (27 m Ω typical)
- RL = series resistance of output inductor
- For the example circuit, $V_{\text{in}} = 24\text{V}$, $F_{\text{s}} = 500 \text{ kHz}$, when $I_{\text{out}} = 0 \text{ A}$, the minimum output voltage is 1.44 V (22)

9.2.2.8 Compensation Component Selection

There are several industry techniques used to compensate DC/DC regulators. The method presented here is easy to calculate and yields high phase margins. For most conditions, the regulator has a phase margin between 60° and 90°. The method presented here ignores the effects of the slope compensation that is internal to the TPS65286. Since the slope compensation is ignored, the actual cross over frequency is usually lower than the cross over frequency used in the calculations. Use SwitcherPro software for a more accurate design.

First, the modulator pole, f_{pmod} , and the esr zero, f_{zmod} must be calculated using [Equation 23](#) and [Equation 24](#). For C_{out} , use a derated value of 22.4 μF . Use [Equation 25](#) and [Equation 26](#) to estimate a starting point for the closed loop crossover frequency f_{co} . Then the required compensation components may be derived. For this design example, f_{pmod} is 12.9 kHz and f_{zmod} is 2730 kHz. [Equation 23](#) is the geometric mean of the modulator pole and the ESR zero and [Equation 24](#) is the geometric mean of the modulator pole and one half the switching frequency. Use a frequency near the lower of these two values as the intended crossover frequency f_{co} . In this case, [Equation 23](#) yields 175 kHz and [Equation 24](#) yields 55.7 kHz. The lower value is 55.7 kHz. A slightly higher frequency of 60.5 kHz is chosen as the intended crossover frequency.

$$f_{\text{pmod}} = \frac{I_{\text{out}}}{2 \cdot \pi \cdot V_{\text{out}} \cdot C_{\text{out}}} \quad (23)$$

$$f_{\text{zmod}} = \frac{I_{\text{out}}}{2 \cdot \pi \cdot \text{RESR} \cdot C_{\text{out}}} \quad (24)$$

$$f_{\text{co}} = \sqrt{f_{\text{pmod}} \cdot f_{\text{zmod}}} \quad (25)$$

$$f_{\text{co}} = \sqrt{f_{\text{pmod}} \cdot \frac{f_{\text{SW}}}{2}} \quad (26)$$

Now the compensation components can be calculated. First calculate the value for R_{C} which sets the gain of the compensated network at the crossover frequency. Use [Equation 27](#) to determine the value of R_{C} .

$$R_{\text{C}} = \frac{2\pi \cdot f_{\text{co}} \cdot V_{\text{O}} \cdot C_{\text{O}}}{g_{\text{M}} \cdot V_{\text{ref}} \cdot g_{\text{m}_{\text{ps}}}} \quad (27)$$

Next calculate the value of C_{C} . Together with R_{C} , C_{C} places a compensation zero at the modulator pole frequency. [Equation 28](#) to determine the value of C_{C} .

$$C_{\text{C}} = \frac{R_{\text{L}} \cdot C_{\text{O}}}{R_{\text{C}}} \quad (28)$$

An additional high frequency pole can be used if necessary by adding a capacitor in parallel with the series combination of R_4 and C_4 . The pole frequency can be placed at the ESR zero frequency of the output capacitor as given by [Equation 24](#). Use [Equation 29](#) to calculate the required capacitor value for C_{b} .

$$C_{\text{b}} = \frac{\text{Resr} \cdot C_{\text{O}}}{R_{\text{C}}} \quad (29)$$

9.2.2.9 Auto-Retry Functionality of USB Switches

Some applications require that an over-current condition disables the part momentarily during a fault condition and re-enables after a pre-set time. This auto-retry functionality can be implemented with external resistors and capacitor shown in [Figure 32](#). During a fault condition, nFAULT pulls low disabling the part. The part is disabled when EN is pulled low, and nFAULT goes high impedance allowing CRETRY1/2 to be charged. The part re-enables when the voltage on EN_SW reaches the turn-on threshold, and the auto-retry time is determined by the resistor/capacitor time constant. The part will continue to cycle in this manner until the fault condition is removed.

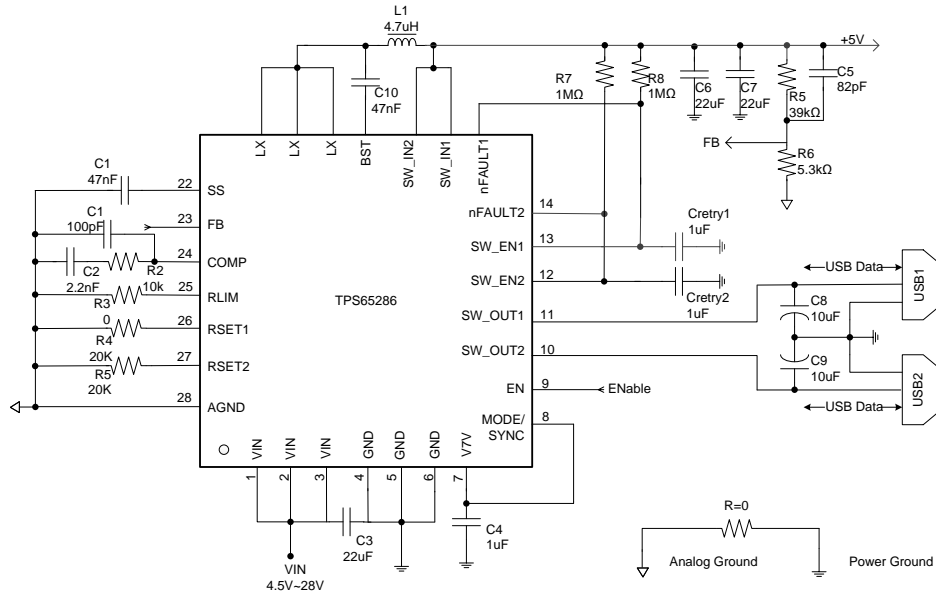

Figure 32. Auto Retry Functionality

Some applications require auto-retry functionality and the ability to enable/disable with an external logic signal. Figure 33 shows how an external logic signal can drive EN_SW through RFAULT and maintain auto-retry functionality. The resistor/capacitor time constant determines the auto-retry time-out period.

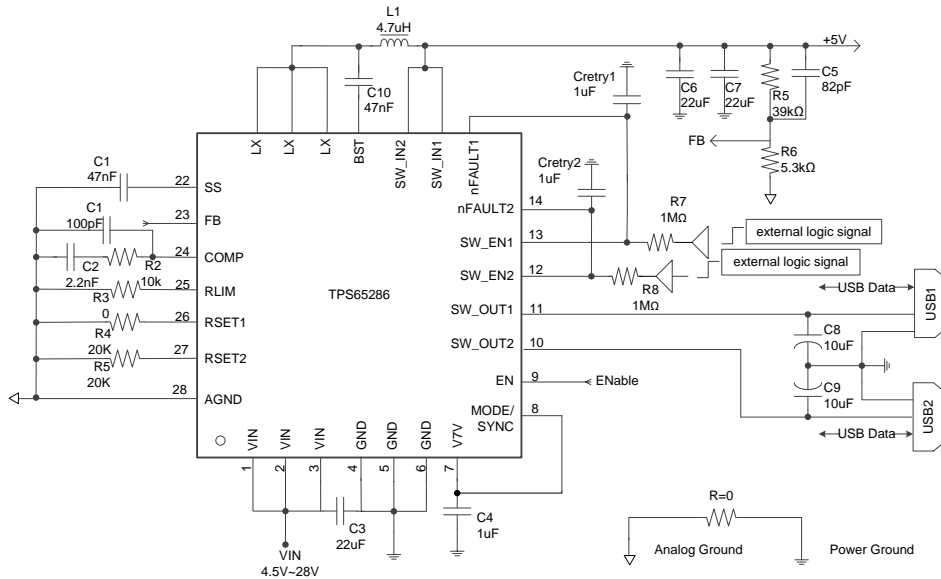

Figure 33. Auto Retry Functionality With External Enable Signal

9.2.3 Application Performance Plots

$T_A = 25^\circ\text{C}$, $V_{IN} = 24\text{ V}$, $V_{OUT} = 5\text{ V}$, $f_{SW} = 500\text{ kHz}$, $R_{nFAULT} = 100\text{ k}\Omega$ (unless otherwise noted)

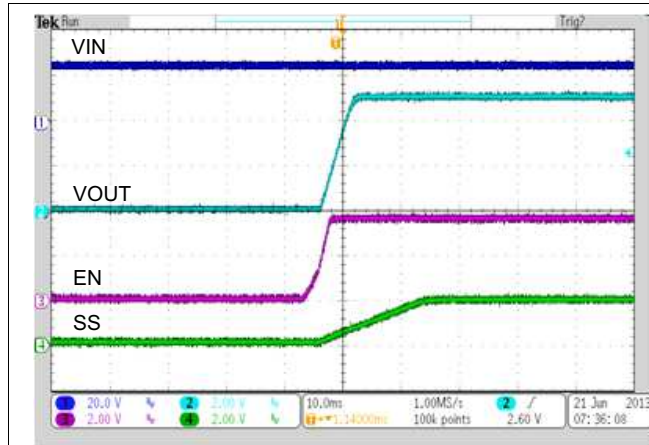

Figure 34. Buck Start Up by EN Terminal With an External 47-nF SS Capacitor

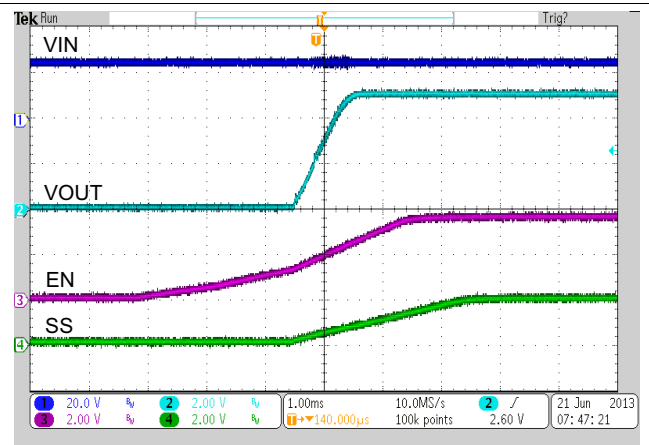

Figure 35. Buck Start Up by EN Terminal With Internal Soft-Start (SS terminal Open)

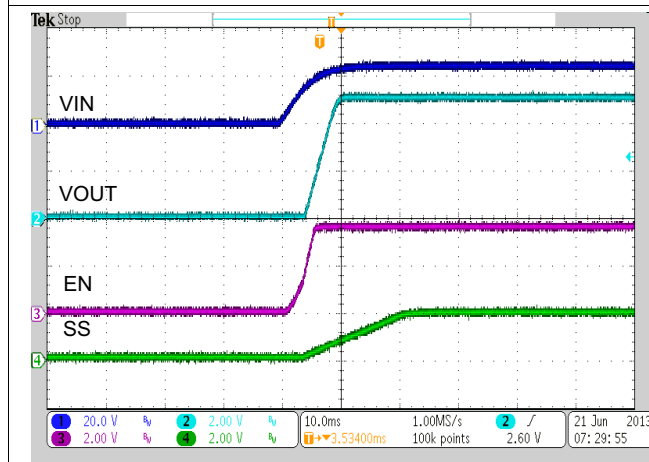

Figure 36. Ramp V_{IN} to Start Up Buck With an External 22-nF SS Capacitor

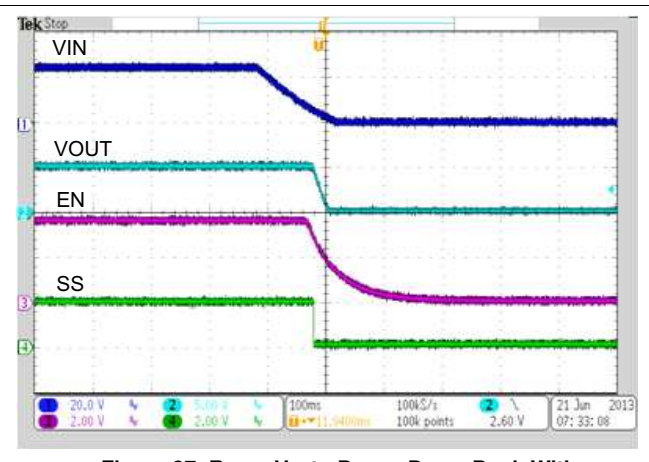

Figure 37. Ramp V_{IN} to Power Down Buck With an External 22-nF SS Capacitor

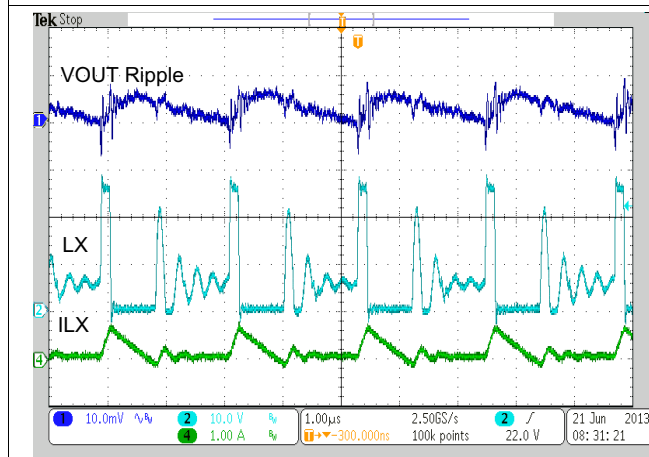

Figure 38. Buck Output Voltage Ripple, $I_{OUT} = 0.1\text{-A PSM Mode}$

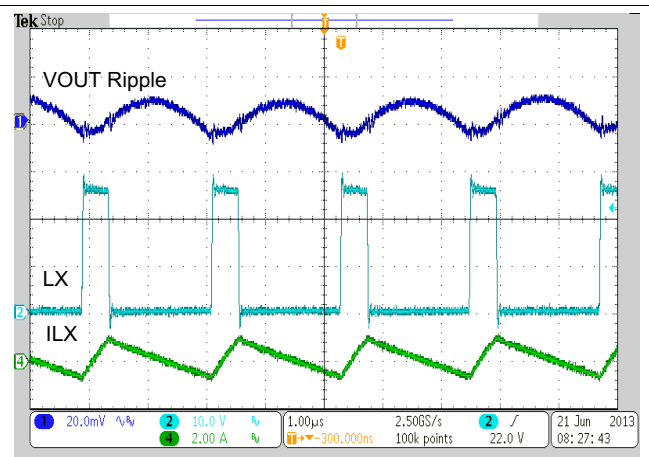

Figure 39. Buck Output Voltage Ripple, $I_{OUT} = 0\text{-A PWM Mode}$

$T_A = 25^\circ\text{C}$, $V_{IN} = 24\text{ V}$, $V_{OUT} = 5\text{ V}$, $f_{SW} = 500\text{ kHz}$, $R_{nFAULT} = 100\text{ k}\Omega$ (unless otherwise noted)

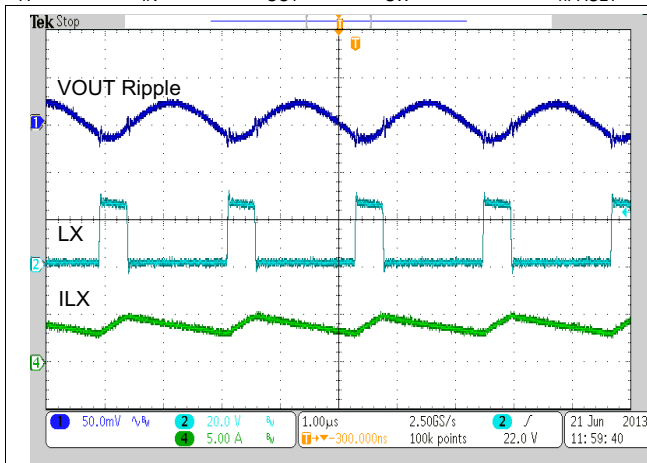

Figure 40. Buck Output Voltage Ripple, $I_{OUT} = 4\text{ A}$

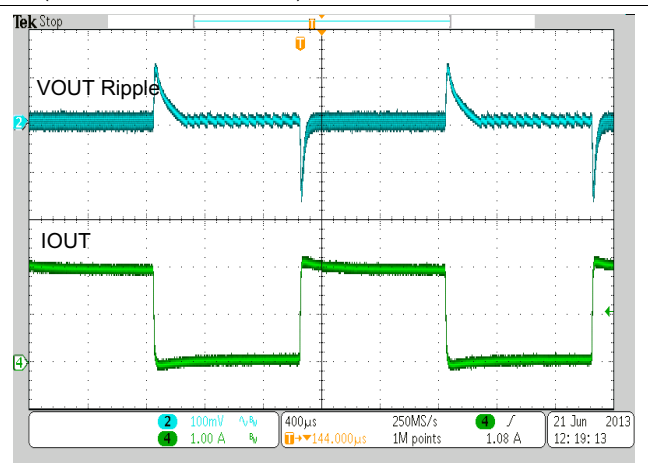

Figure 41. Buck Output Load Transient in PSM Mode, $I_{OUT} = 0 - 2\text{ A}$

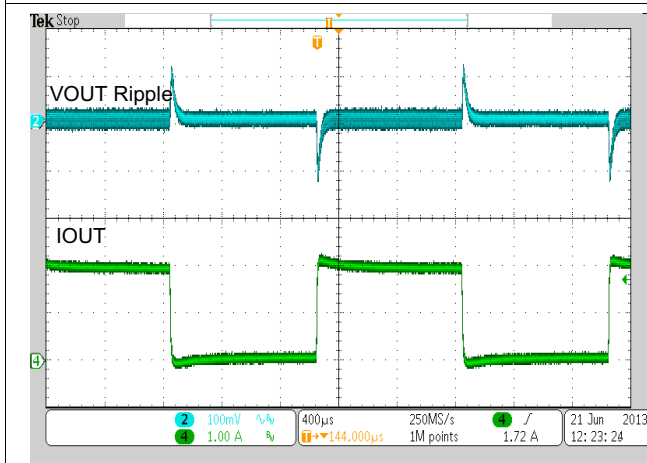

Figure 42. Buck Output Load Transient in PWM Mode, $I_{OUT} = 0 - 2\text{ A}$

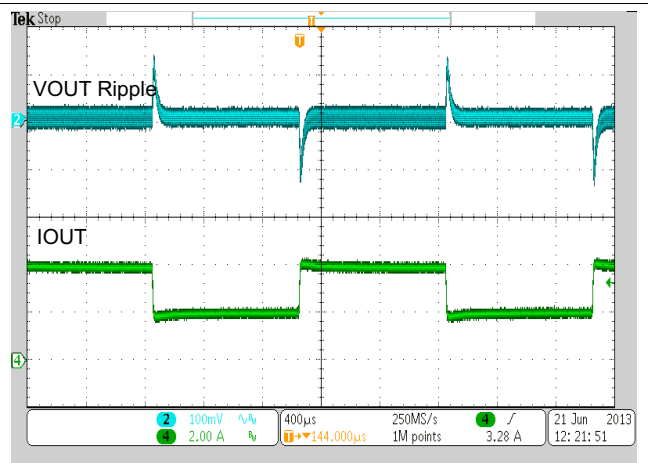

Figure 43. Buck Output Load Transient in PWM Mode, $I_{OUT} = 2 - 4\text{ A}$

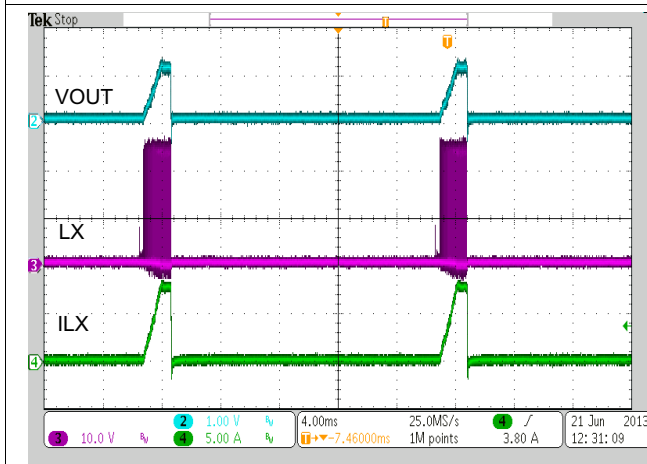

Figure 44. Buck Hiccup Response to Hard Short Circuit

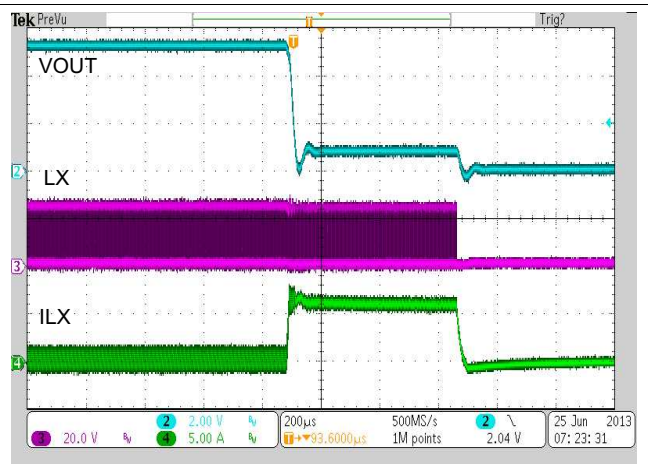

Figure 45. Buck Output Hard Short Response (Zoom In)

$T_A = 25^\circ\text{C}$, $V_{IN} = 24\text{ V}$, $V_{OUT} = 5\text{ V}$, $f_{SW} = 500\text{ kHz}$, $R_{nFAULT} = 100\text{ k}\Omega$ (unless otherwise noted)

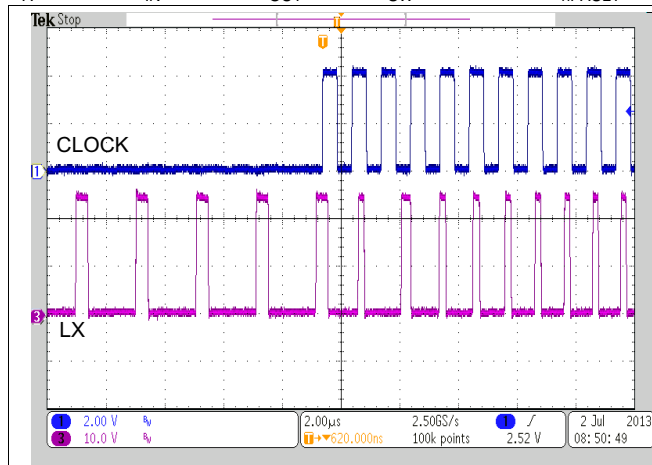

Figure 46. Clock Synchronization Operation

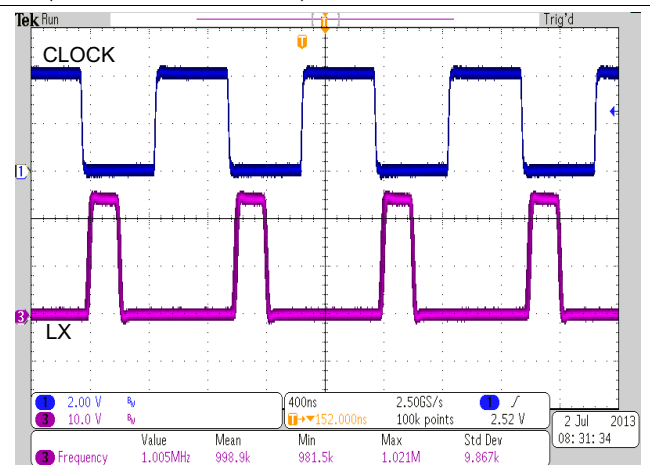

Figure 47. Clock Synchronization at 1 MHz

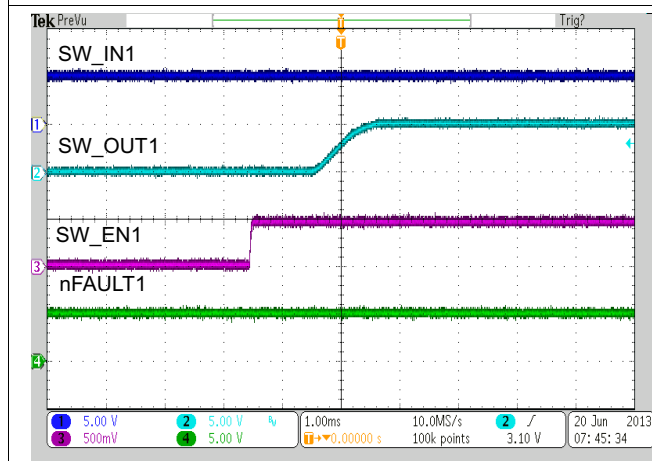

Figure 48. Power Switch1 Turn on Delay and Rise Time

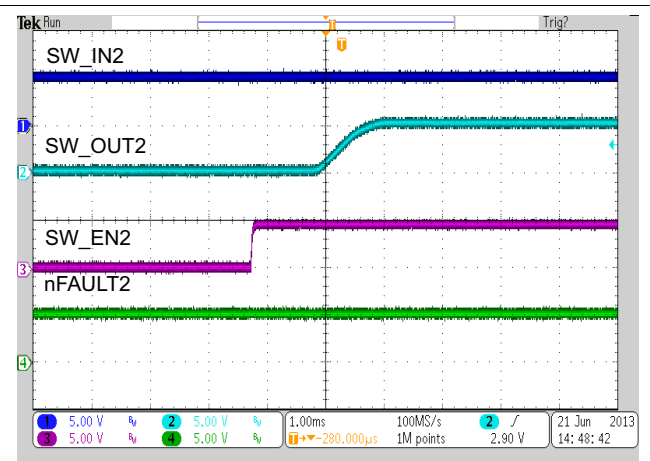

Figure 49. Power Switch2 Turn on Delay and Rise Time

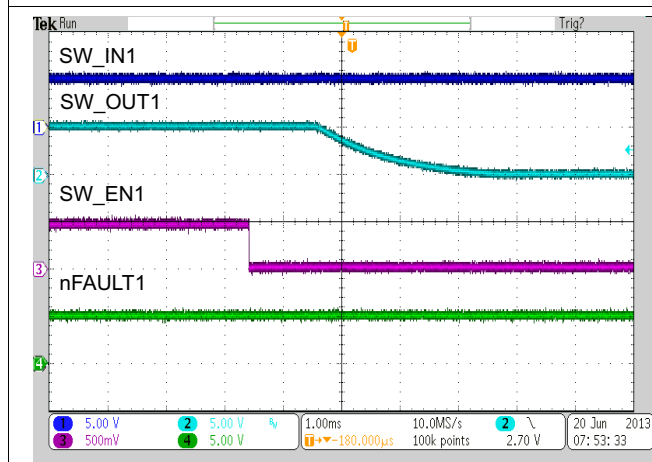

Figure 50. Power Switch1 Turn off Delay and Fall Time, $R_{OUT} = 50\ \Omega$, $C_{OUT} = 10\ \mu\text{F}$

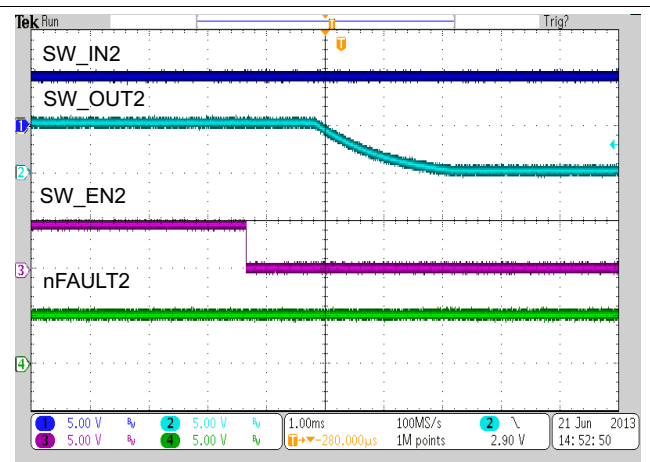

Figure 51. Power Switch2 Turn off Delay and Fall Time, $R_{OUT} = 50\ \Omega$, $C_{OUT} = 10\ \mu\text{F}$

$T_A = 25^\circ\text{C}$, $V_{IN} = 24\text{ V}$, $V_{OUT} = 5\text{ V}$, $f_{SW} = 500\text{ kHz}$, $R_{nFAULT} = 100\text{ k}\Omega$ (unless otherwise noted)

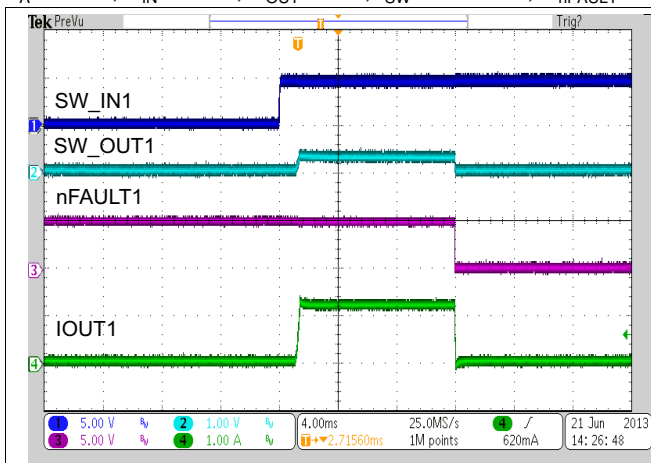

Figure 52. Power Switch1 Enable into Short Circuit

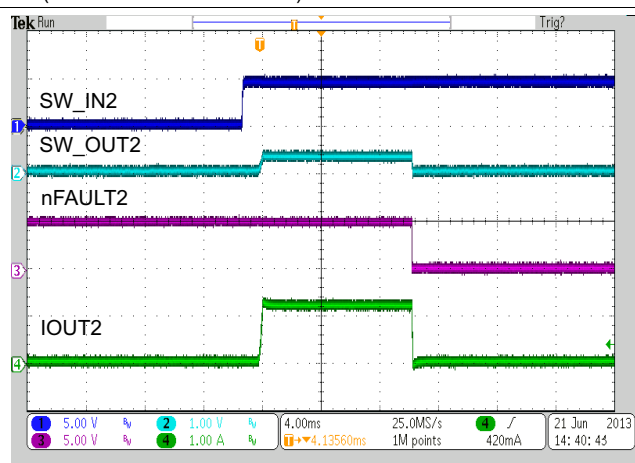

Figure 53. Power Switch2 Enable into Short Circuit

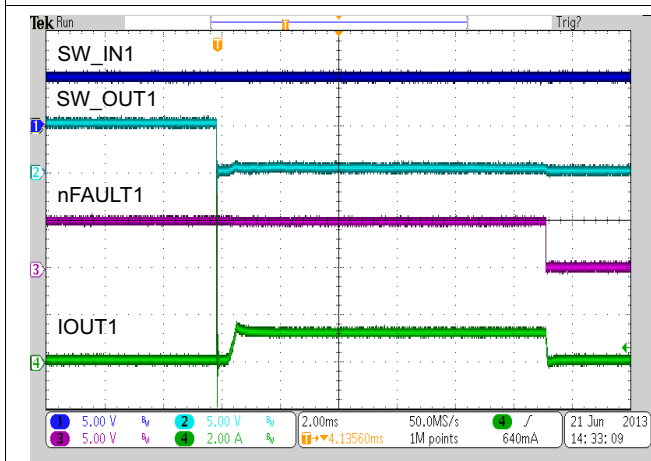

Figure 54. Power Switch1 Current Limit Operation

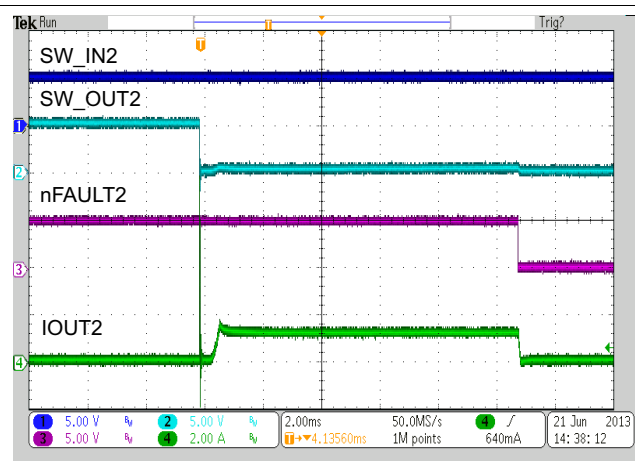

Figure 55. Power Switch2 Current Limit Operation

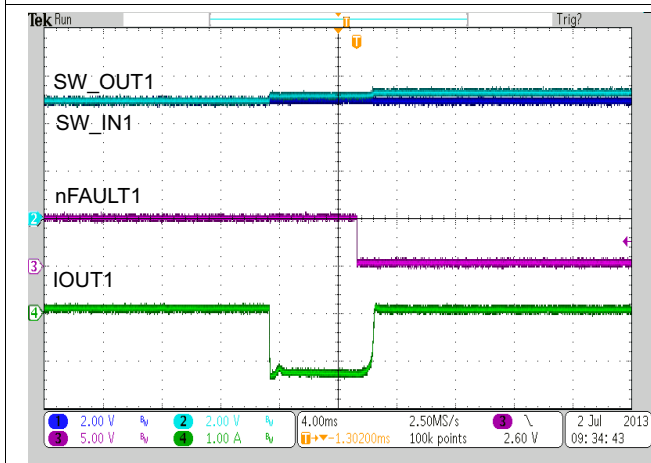

Figure 56. Power Switch1 Reverse Voltage Protection Response

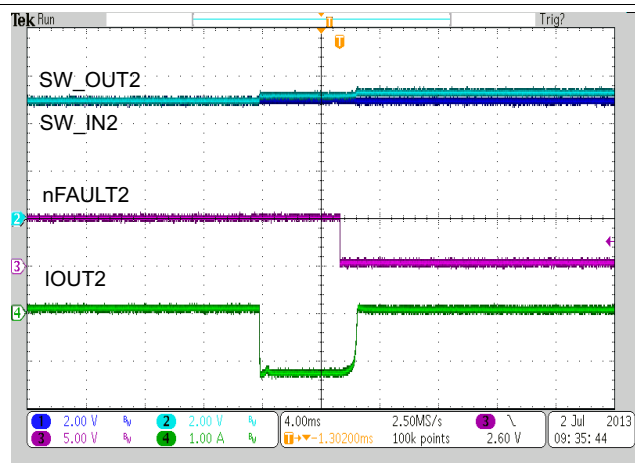

Figure 57. Power Switch2 Reverse Voltage Protection Response

10 Power Supply Recommendations

The total power dissipation inside TPS65286 should not to exceed the maximum allowable junction temperature of 125°C. The maximum allowable power dissipation is a function of the thermal resistance of the package (θ_{JA}) and ambient temperature. The analysis below gives an approximation in calculating junction temperature based on the power dissipation in the package. However, it is important to note that thermal analysis is strongly dependent on additional system level factors. Such factors include air flow, board layout, copper thickness and surface area, and proximity to other devices dissipating power. Good thermal design practice must include all system level factors in addition to individual component analysis.

To calculate the temperature inside the device under continuous load, use the following procedure.

1. Define the total continuous current through buck converter (including the load current through power switches). Make sure the continuous current does not exceed maximum load current requirement.
2. From the graphs below, determine the expected losses (Y axis) in watts for buck converter inside the device. The loss P_{D_BUCK} depends on the input supply and the selected switching frequency.
3. Determine the load current I_{OUT1} and I_{OUT2} through the power switches. Read $R_{DS(on)1/2}$ of power switch from the typical characteristics graph.
4. The power loss through power switches can be calculated by $P_{D_PW} = R_{DS1(on)} \times I_{OUT1} + R_{DS2(on)} \times I_{OUT2}$.
5. The Dissipating Rating Table provides the thermal resistance θ_{JA} for specific packages and board layouts.
6. To calculate the maximum temperature inside the IC, use the following formula.

$$T_J = (P_{D_BUCK} + P_{D_PW}) \times \theta_{JA} + T_A$$

where

- T_A = Ambient temperature (°C)
- θ_{JA} = Thermal resistance (°C/W)
- P_{D_BUCK} = Total power dissipation in buck converter (W)
- P_{D_PW} = Total power dissipation in power switches (W) (30)

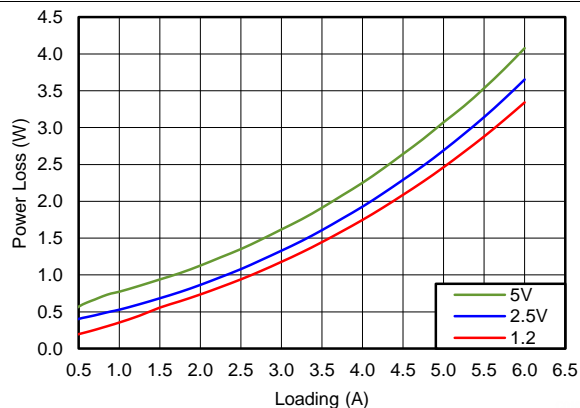

Figure 58. Power Dissipation of TPS65286, $V_{IN} = 24\text{ V}$

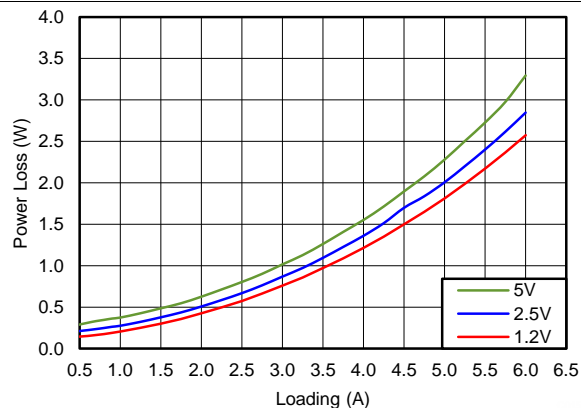

Figure 59. Power Dissipation of TPS65286, $V_{IN} = 12\text{ V}$

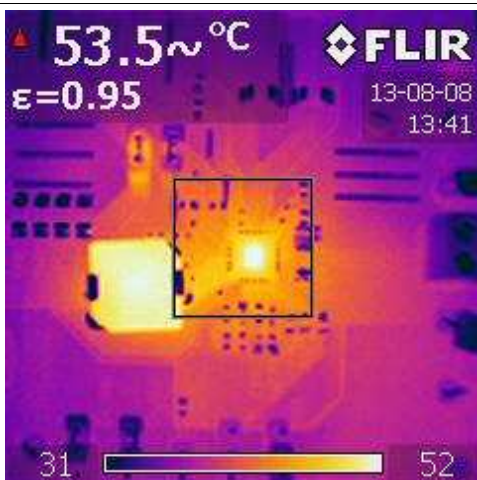

Figure 60. Thermal Signature of TPS65286EVM, $T_A = \text{Room Temperature}$, $V_{IN} = 24\text{ V}$, $V_{OUT} \text{ to } V_{SW_in} = 5\text{ V}/0\text{ A}$, $I_{SW_OUT1/2} = 1.2\text{ A}$
 EVM Board: 4-Layer PCB, 1.6 mm Thickness, 2 oz. Copper Thickness, 65-mm x 65-mm Size, 25 Vias at Thermal Pad

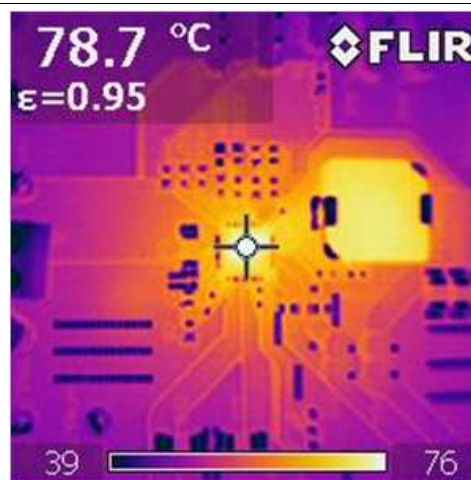

Figure 61. Thermal Signature of TPS65286EVM, $T_A = \text{Room Temperature}$, $V_{IN} = 24\text{ V}$, $V_{OUT} = 5\text{ V}/5\text{ A}$, $I_{SW_OUT1/2} = 0\text{ A}$
 EVM Board: 4-Layer PCB, 1.6 mm Thickness, 2 oz. Copper Thickness, 65-mm x 65-mm Size, 25 Vias at Thermal Pad

11 Layout

11.1 Layout Guidelines

When laying out the printed circuit board, the following guideline should be used to ensure proper operation of the IC. These items are also illustrated graphically in the layout diagram of [Figure 62](#).

- There are several signals paths that conduct fast changing currents or voltages that can interact with stray inductance or parasitic capacitance to generate noise or degrade the power supplies performance. To help eliminate these problems, the VIN terminal should be bypassed to ground with a low ESR ceramic bypass capacitor with X5R or X7R dielectric. This capacitor provides the AC current into the internal power MOSFETs. Connect the (+) terminal of the input capacitor as close as possible to the VIN terminal, and Connect the (-) terminal of the input capacitor as close as possible to the PGND terminal. Care should be taken to minimize the loop area formed by the bypass capacitor connections, the VIN terminals, and the power ground PGND connections.
- Since the LX connection is the switching node, the output inductor should be located close to the LX terminal, and the area of the PCB conductor minimized to prevent excessive capacitive coupling. Keep the switching node, LX, away from all sensitive small-signal nodes.
- Connect V7V decoupling capacitor connected close to the IC, between the V7V and the power ground PGND terminal. This capacitor carries the MOSFET drivers' current peaks.
- Place the output filter capacitor of buck converter close to SW_IN terminals. Try to minimize the ground conductor length while maintaining adequate width.
- AGND terminal should be separately routed to the (-) terminal of V7V bypass capacitor to avoid switching grounding path. A ground plane is recommended connecting to this ground path.
- The compensation should be as close as possible to the COMP terminals. The COMP and ROsc terminals are sensitive to noise so the components associated to these terminals should be located as close as possible to the IC and routed with minimal lengths of trace. Flood all unused areas on all layers with copper. Flooding with copper will reduce the temperature rise of power components. You can connect the copper areas to PGND, AGND, VIN or any other DC rail in your system.
- There is no electric signal internal connected to thermal pad in the device. Nevertheless connect exposed pad beneath the IC to ground. Always solder thermal pad to the board, and have as many vias as possible on the PCB to enhance power dissipation.

12 Device and Documentation Support

12.1 Trademarks

WEBENCH is a registered trademark of Texas Instruments.

12.2 Electrostatic Discharge Caution



These devices have limited built-in ESD protection. The leads should be shorted together or the device placed in conductive foam during storage or handling to prevent electrostatic damage to the MOS gates.

12.3 Glossary



[SLYZ022](#) — *TI Glossary*.

This glossary lists and explains terms, acronyms and definitions.

13 Mechanical, Packaging, and Orderable Information

The following pages include mechanical packaging and orderable information. This information is the most current data available for the designated devices. This data is subject to change without notice and revision of this document. For browser-based versions of this data sheet, refer to the left-hand navigation.

PACKAGING INFORMATION

Orderable Device	Status (1)	Package Type	Package Drawing	Pins	Package Qty	Eco Plan (2)	Lead finish/ Ball material (6)	MSL Peak Temp (3)	Op Temp (°C)	Device Marking (4/5)	Samples
TPS65286RHDR	ACTIVE	VQFN	RHD	28	3000	RoHS & Green	NIPDAU	Level-3-260C-168 HR	-40 to 85	TPS 65286	
TPS65286RHDT	ACTIVE	VQFN	RHD	28	250	RoHS & Green	NIPDAU	Level-3-260C-168 HR	-40 to 85	TPS 65286	

(1) The marketing status values are defined as follows:

ACTIVE: Product device recommended for new designs.

LIFEBUY: TI has announced that the device will be discontinued, and a lifetime-buy period is in effect.

NRND: Not recommended for new designs. Device is in production to support existing customers, but TI does not recommend using this part in a new design.

PREVIEW: Device has been announced but is not in production. Samples may or may not be available.

OBsolete: TI has discontinued the production of the device.

(2) **RoHS:** TI defines "RoHS" to mean semiconductor products that are compliant with the current EU RoHS requirements for all 10 RoHS substances, including the requirement that RoHS substance do not exceed 0.1% by weight in homogeneous materials. Where designed to be soldered at high temperatures, "RoHS" products are suitable for use in specified lead-free processes. TI may reference these types of products as "Pb-Free".

RoHS Exempt: TI defines "RoHS Exempt" to mean products that contain lead but are compliant with EU RoHS pursuant to a specific EU RoHS exemption.

Green: TI defines "Green" to mean the content of Chlorine (Cl) and Bromine (Br) based flame retardants meet JS709B low halogen requirements of <=1000ppm threshold. Antimony trioxide based flame retardants must also meet the <=1000ppm threshold requirement.

(3) MSL, Peak Temp. - The Moisture Sensitivity Level rating according to the JEDEC industry standard classifications, and peak solder temperature.

(4) There may be additional marking, which relates to the logo, the lot trace code information, or the environmental category on the device.

(5) Multiple Device Markings will be inside parentheses. Only one Device Marking contained in parentheses and separated by a "~" will appear on a device. If a line is indented then it is a continuation of the previous line and the two combined represent the entire Device Marking for that device.

(6) Lead finish/Ball material - Orderable Devices may have multiple material finish options. Finish options are separated by a vertical ruled line. Lead finish/Ball material values may wrap to two lines if the finish value exceeds the maximum column width.

Important Information and Disclaimer:The information provided on this page represents TI's knowledge and belief as of the date that it is provided. TI bases its knowledge and belief on information provided by third parties, and makes no representation or warranty as to the accuracy of such information. Efforts are underway to better integrate information from third parties. TI has taken and continues to take reasonable steps to provide representative and accurate information but may not have conducted destructive testing or chemical analysis on incoming materials and chemicals. TI and TI suppliers consider certain information to be proprietary, and thus CAS numbers and other limited information may not be available for release.

In no event shall TI's liability arising out of such information exceed the total purchase price of the TI part(s) at issue in this document sold by TI to Customer on an annual basis.

TAPE AND REEL INFORMATION

QUADRANT ASSIGNMENTS FOR PIN 1 ORIENTATION IN TAPE

*All dimensions are nominal

Device	Package Type	Package Drawing	Pins	SPQ	Reel Diameter (mm)	Reel Width W1 (mm)	A0 (mm)	B0 (mm)	K0 (mm)	P1 (mm)	W (mm)	Pin1 Quadrant
TPS65286RHDR	VQFN	RHD	28	3000	330.0	12.4	5.3	5.3	1.1	8.0	12.0	Q2
TPS65286RHDT	VQFN	RHD	28	250	180.0	12.4	5.3	5.3	1.1	8.0	12.0	Q2

TAPE AND REEL BOX DIMENSIONS

*All dimensions are nominal

Device	Package Type	Package Drawing	Pins	SPQ	Length (mm)	Width (mm)	Height (mm)
TPS65286RHDR	VQFN	RHD	28	3000	346.0	346.0	33.0
TPS65286RHDT	VQFN	RHD	28	250	210.0	185.0	35.0

GENERIC PACKAGE VIEW

RHD 28

VQFN - 1 mm max height

5 x 5 mm, 0.5 mm pitch

PLASTIC QUAD FLATPACK - NO LEAD

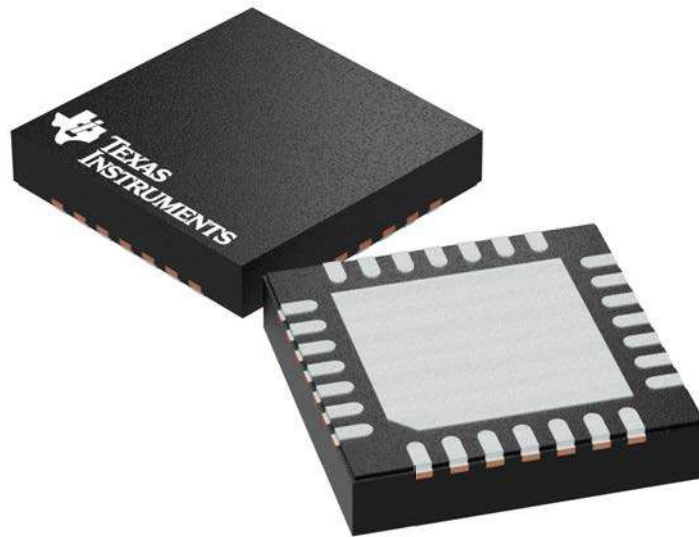

Images above are just a representation of the package family, actual package may vary.
Refer to the product data sheet for package details.

4204400/G

RHD0028B

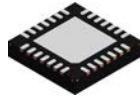

PACKAGE OUTLINE

VQFN - 1 mm max height

PLASTIC QUAD FLATPACK - NO LEAD

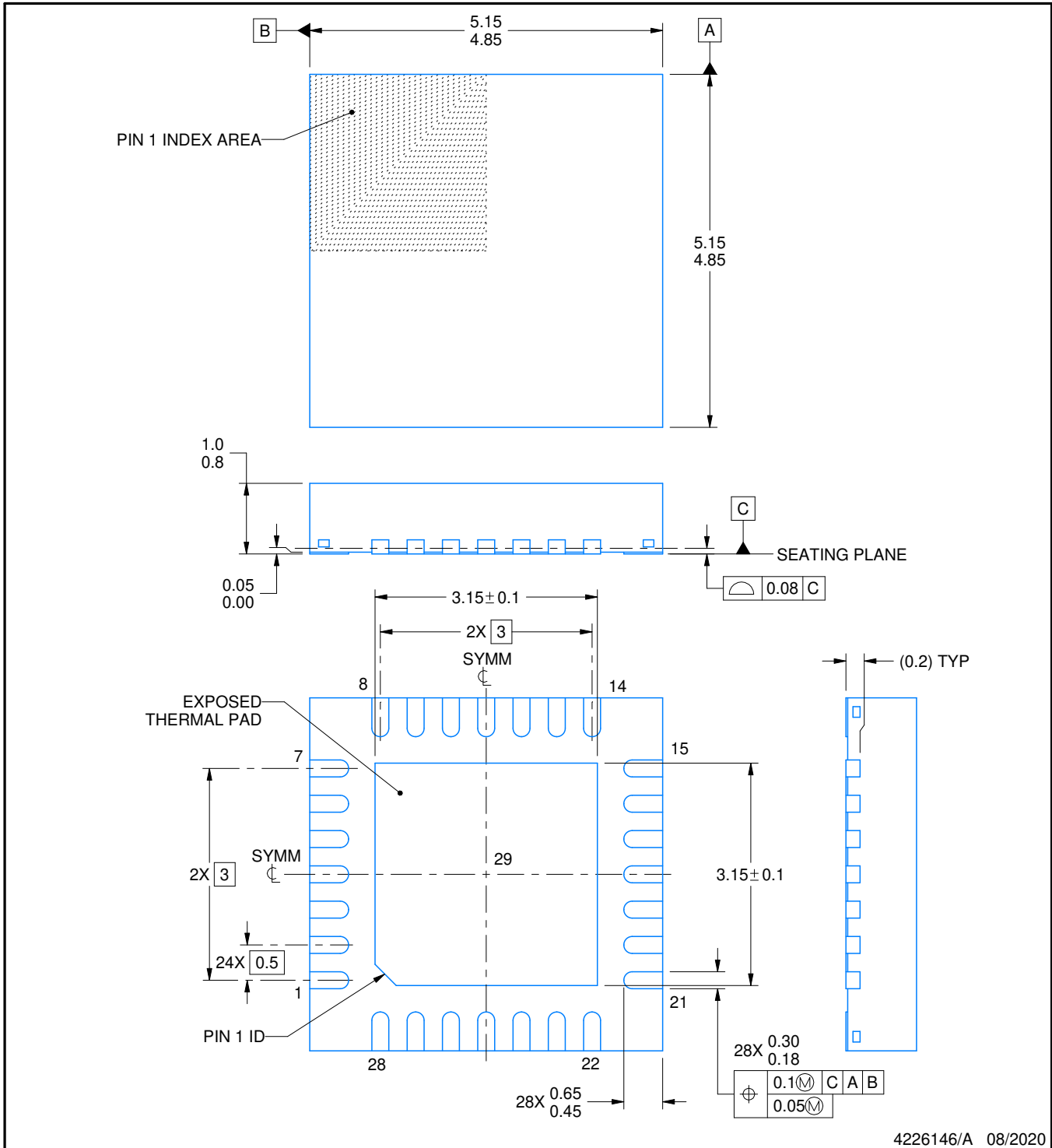

NOTES:

1. All linear dimensions are in millimeters. Any dimensions in parenthesis are for reference only. Dimensioning and tolerancing per ASME Y14.5M.
2. This drawing is subject to change without notice.
3. The package thermal pad must be soldered to the printed circuit board for thermal and mechanical performance.

EXAMPLE BOARD LAYOUT

RHD0028B

VQFN - 1 mm max height

PLASTIC QUAD FLATPACK - NO LEAD

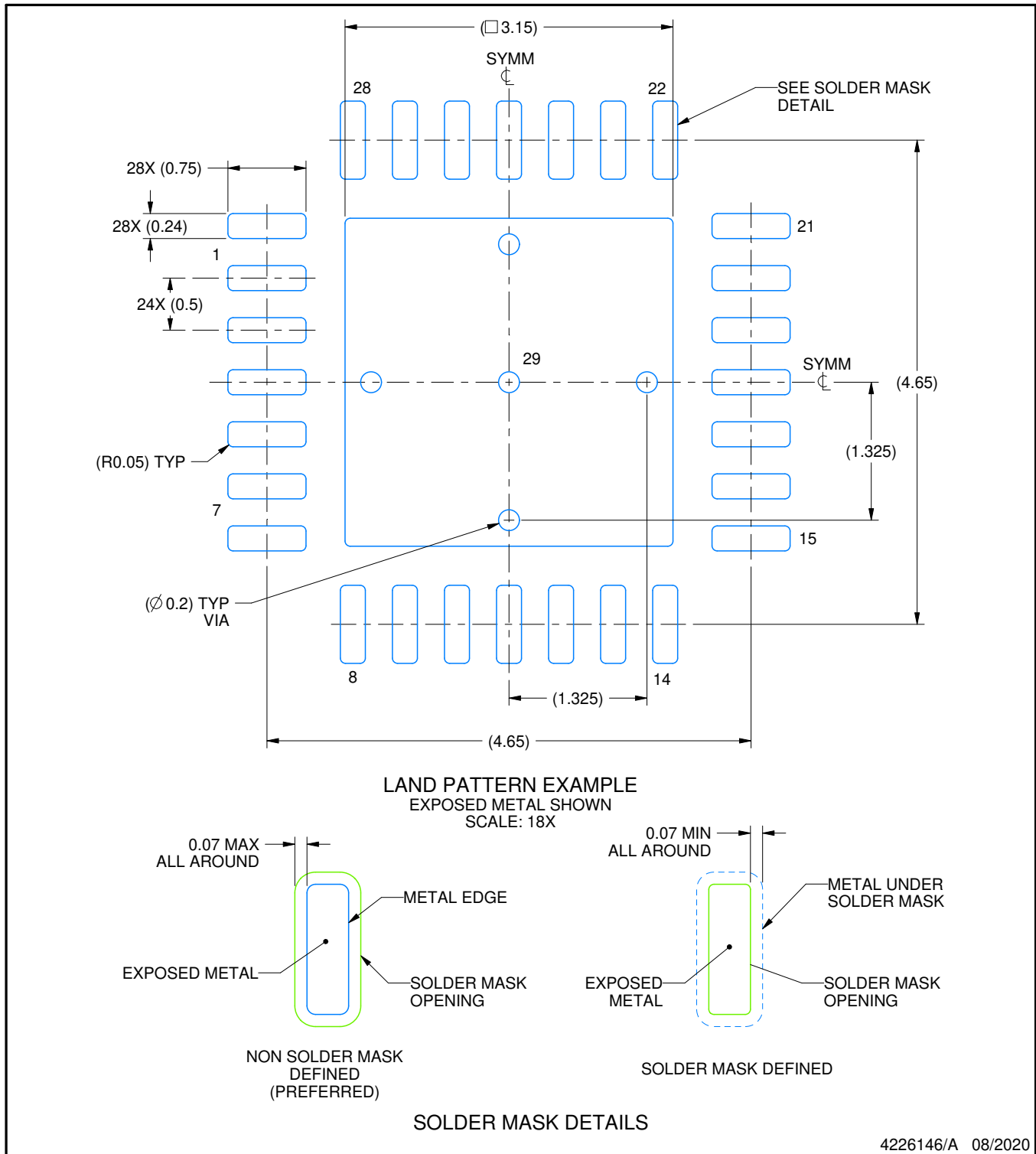

4226146/A 08/2020

NOTES: (continued)

4. This package is designed to be soldered to a thermal pad on the board. For more information, see Texas Instruments literature number SLUA271 (www.ti.com/lit/sluea271).
5. Vias are optional depending on application, refer to device data sheet. If any vias are implemented, refer to their locations shown on this view. It is recommended that vias under paste be filled, plugged or tented.

EXAMPLE STENCIL DESIGN

RHD0028B

VQFN - 1 mm max height

PLASTIC QUAD FLATPACK - NO LEAD

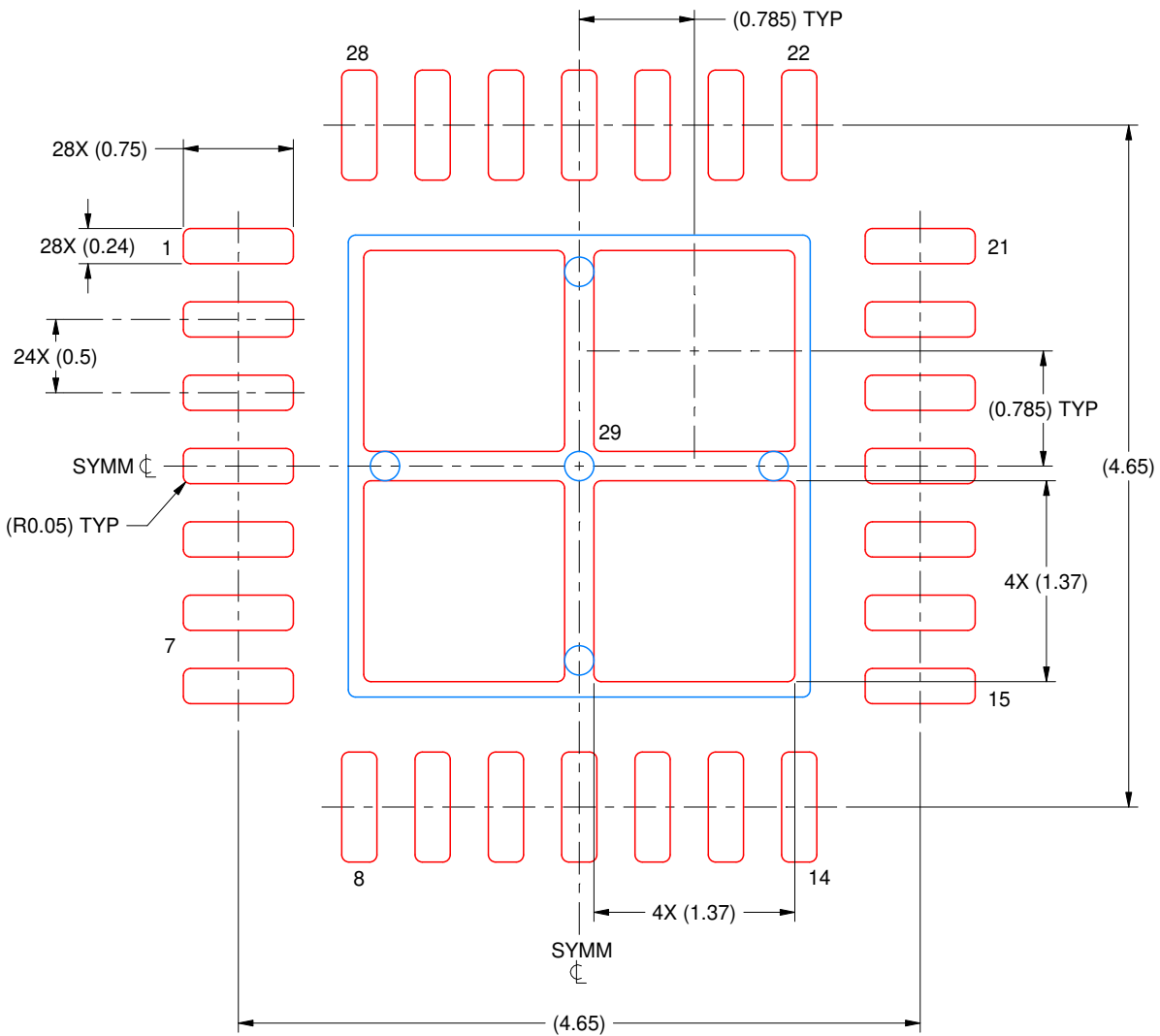

SOLDER PASTE EXAMPLE
BASED ON 0.125 MM THICK STENCIL
SCALE: 20X

EXPOSED PAD 29
76% PRINTED SOLDER COVERAGE BY AREA UNDER PACKAGE

4226146/A 08/2020

NOTES: (continued)

6. Laser cutting apertures with trapezoidal walls and rounded corners may offer better paste release. IPC-7525 may have alternate design recommendations.

IMPORTANT NOTICE AND DISCLAIMER

TI PROVIDES TECHNICAL AND RELIABILITY DATA (INCLUDING DATA SHEETS), DESIGN RESOURCES (INCLUDING REFERENCE DESIGNS), APPLICATION OR OTHER DESIGN ADVICE, WEB TOOLS, SAFETY INFORMATION, AND OTHER RESOURCES "AS IS" AND WITH ALL FAULTS, AND DISCLAIMS ALL WARRANTIES, EXPRESS AND IMPLIED, INCLUDING WITHOUT LIMITATION ANY IMPLIED WARRANTIES OF MERCHANTABILITY, FITNESS FOR A PARTICULAR PURPOSE OR NON-INFRINGEMENT OF THIRD PARTY INTELLECTUAL PROPERTY RIGHTS.

These resources are intended for skilled developers designing with TI products. You are solely responsible for (1) selecting the appropriate TI products for your application, (2) designing, validating and testing your application, and (3) ensuring your application meets applicable standards, and any other safety, security, regulatory or other requirements.

These resources are subject to change without notice. TI grants you permission to use these resources only for development of an application that uses the TI products described in the resource. Other reproduction and display of these resources is prohibited. No license is granted to any other TI intellectual property right or to any third party intellectual property right. TI disclaims responsibility for, and you will fully indemnify TI and its representatives against, any claims, damages, costs, losses, and liabilities arising out of your use of these resources.

TI's products are provided subject to [TI's Terms of Sale](#) or other applicable terms available either on [ti.com](https://www.ti.com) or provided in conjunction with such TI products. TI's provision of these resources does not expand or otherwise alter TI's applicable warranties or warranty disclaimers for TI products.

TI objects to and rejects any additional or different terms you may have proposed.

Mailing Address: Texas Instruments, Post Office Box 655303, Dallas, Texas 75265
Copyright © 2023, Texas Instruments Incorporated