

Small switching (30V, 0.1A)

2SK3019

●Applications

Interfacing, switching (30V, 100mA)

●Features

- 1) Low on-resistance.
- 2) Fast switching speed.
- 3) Low voltage drive (2.5V) makes this device ideal for portable equipment.
- 4) Easily designed drive circuits.
- 5) Easy to parallel.

●Structure

Silicon N-channel
MOSFET

●External dimensions (Units : mm)

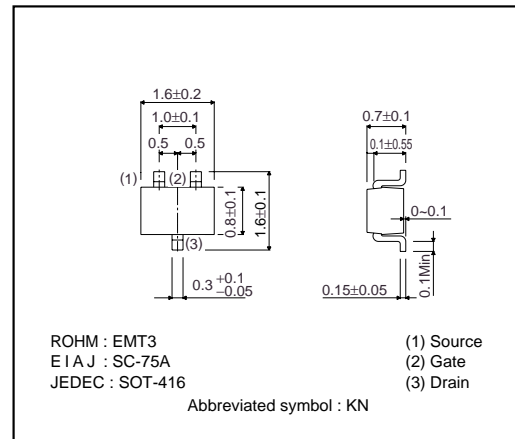

●Absolute maximum ratings (Ta=25°C)

Parameter	Symbol	Limits	Unit	
Drain-source voltage	V_{DS}	30	V	
Gate-source voltage	V_{GS}	± 20	V	
Drain current	Continuous	I_D	100	mA
	Pulsed	I_{DP}^{*1}	200	mA
Reverse drain current	Continuous	I_{DR}	100	mA
	Pulsed	I_{DRP}^{*1}	200	mA
Total power dissipation (Tc=25°C)	P_D^{*2}	150	mW	
Channel temperature	Tch	150	°C	
Storage temperature	Tstg	-55~+150	°C	

*1 $P_w \leq 10 \mu s$, Duty cycle $\leq 50\%$

*2 With each pin mounted on the recommended lands.

●Equivalent circuit

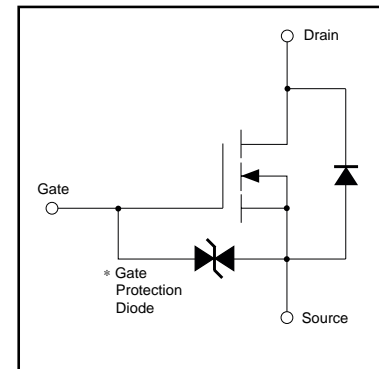

*A protection diode is included between the gate and the source terminals to protect the diode against static electricity when the product is in use. Use a protection circuit when the fixed voltages are exceeded.

Transistor

●Electrical characteristics (Ta=25°C)

Parameter	Symbol	Min.	Typ.	Max.	Unit	Conditions
Gate-source leakage	I _{gss}	–	–	±1	μA	V _{GS} =±20V, V _{DS} =0V
Drain-source breakdown voltage	V _{(BR)DSS}	30	–	–	V	I _D =10μA, V _{GS} =0V
Zero gate voltage drain current	I _{DSS}	–	–	1.0	μA	V _{DS} =30V, V _{GS} =0V
Gate threshold voltage	V _{GS(th)}	0.8	–	1.5	V	V _{DS} =3V, I _D =100μA
Static drain-source on-state resistance	R _{DS(on)}	–	5	8	Ω	I _D =10mA, V _{GS} =4V
	R _{DS(on)}	–	7	13	Ω	I _D =1mA, V _{GS} =2.5V
Forward transfer admittance	Y _{fs}	20	–	–	ms	I _D =10mA, V _{DS} =3V
Input capacitance	C _{iss}	–	13	–	pF	V _{DS} =5V
Output capacitance	C _{oss}	–	9	–	pF	V _{GS} =0V
Reverse transfer capacitance	C _{rss}	–	4	–	pF	f=1MHz
Turn-on delay time	t _{d(on)}	–	15	–	ns	I _D =10mA, V _{DD} ≐5V
Rise time	t _r	–	35	–	ns	V _{GS} =5V
Turn-off delay time	t _{d(off)}	–	80	–	ns	R _L =500Ω
Fall time	t _f	–	80	–	ns	R _{GS} =10Ω

●Packaging specifications

Type	Package	Taping
	Code	TL
	Basic ordering unit (pieces)	3000
2SK3019		○

●Electrical characteristic curves

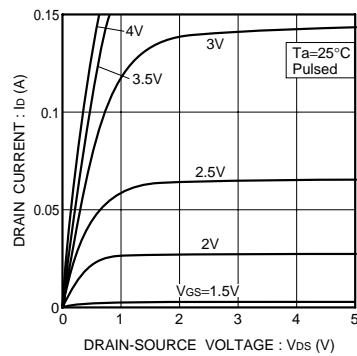

Fig.1 Typical output characteristics

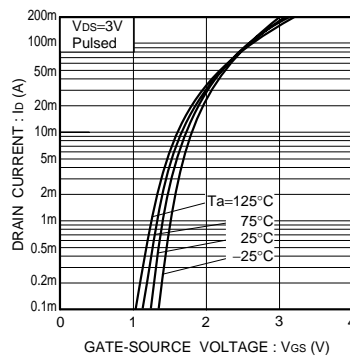

Fig.2 Typical transfer characteristics

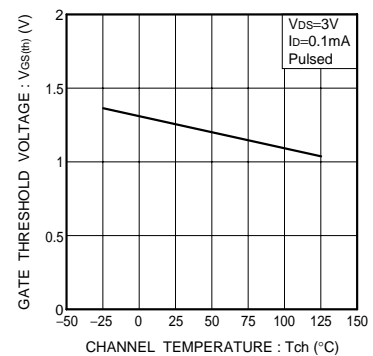

Fig.3 Gate threshold voltage vs. channel temperature

Transistor

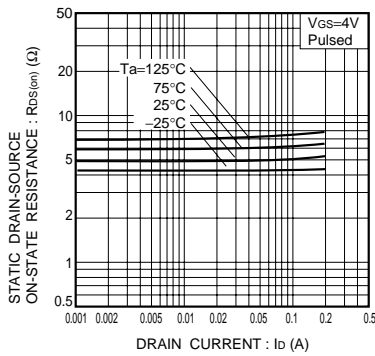

Fig.4 Static drain-source on-state resistance vs. drain current (I)

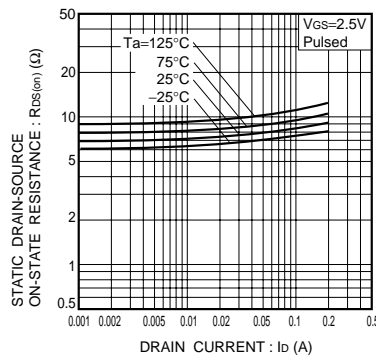

Fig.5 Static drain-source on-state resistance vs. drain current (II)

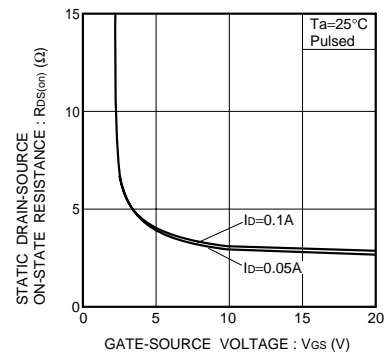

Fig.6 Static drain-source on-state resistance vs. gate-source voltage

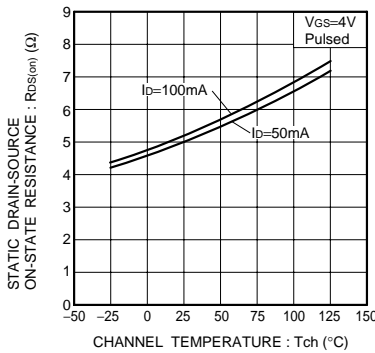

Fig.7 Static drain-source on-state resistance vs. channel temperature

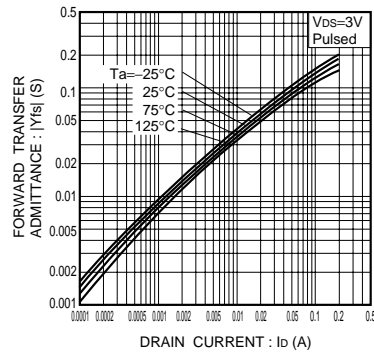

Fig.8 Forward transfer admittance vs. drain current

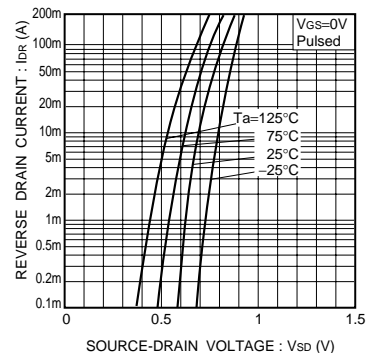

Fig.9 Reverse drain current vs. source-drain voltage (I)

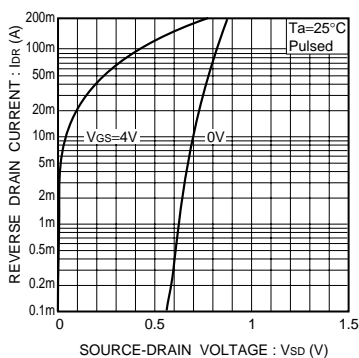

Fig.10 Reverse drain current vs. source-drain voltage (II)

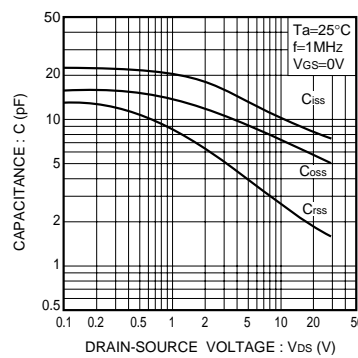

Fig.11 Typical capacitance vs. drain-source voltage

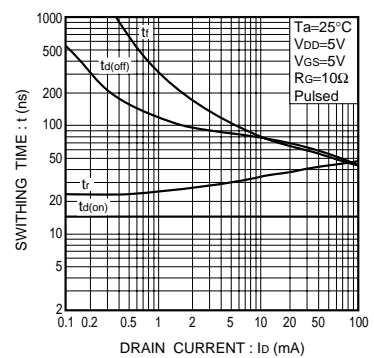

Fig.12 Switching characteristics (See Figures 13 and 14 for the measurement circuit and resultant waveforms)

Transistor

● Switching characteristics measurement circuit

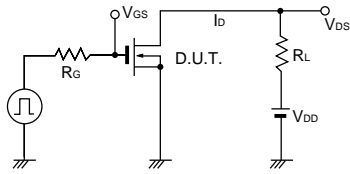

Fig.13 Switching time measurement circuit

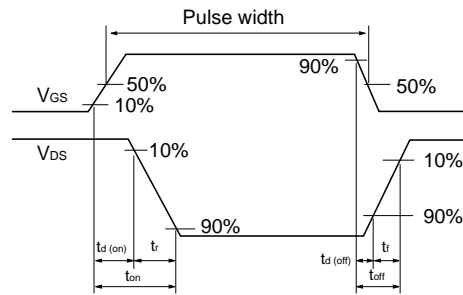

Fig.14 Switching time waveforms