

**W22LOC-P06MPHO-720S**  
**series\_l, type\_w2**

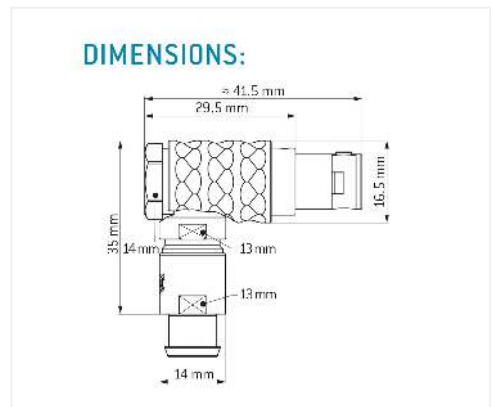

**General information**

<b>Part number</b>	W22LOC-P06MPHO-720S
<b>Termination</b>	solder
<b>Size</b>	2
<b>Locking principle</b>	push
<b>Coding</b>	0_key
<b>Cable Diameter</b>	cable_mini_72
<b>Cable outlet</b>	bend_relief

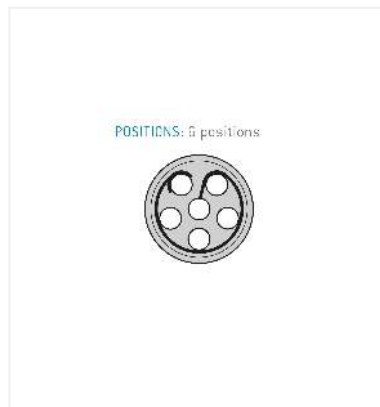

**Contact insert description**

<b>Number of contacts</b>	6
<b>Contact type</b>	pins
<b>Contact diameter</b>	13mm
<b>Insulator material</b>	peek
<b>Wire cross section</b>	20_awg
<b>Termination</b>	solder
<b>Termination diameter</b>	11mm

reverse\_gender\_on\_request

**Technical information**

<b>Max. creepage and air clearance distance</b>	13_mm	15_mm
<b>Nominal current single contact</b>	12_a	iec_60512_5_2
<b>Nominal current insert</b>	9 A	vde_0298_4
<b>Test voltage</b>	15_kv_ac	sae_13441

safety\_text

## Mechanical and environmental data

Degree of protection*	ip50
-----------------------	------

Operating temperature	40_120_c
-----------------------	----------

Mating cycles	5000
---------------	------

mated\_unmated

## Material and surface treatments

Housing	m_chrome
---------	----------

Contact	cu_alloy_gold
---------	---------------

safety\_text\_2

ul\_text

illustrative\_text