

Matsuo's temperature control devices contribute to energy saving for the future of our global environment.

Matsuo Electric Co., Ltd. was founded in 1960.

Since the foundation, we have been proud of our "no imitation" policy in that we always try to make what others do not make.

Certified by ISO 9001

All products compliant to the RoHS Directive

TPS Certification List

Model	Standard	CMJ (Japan)	UL (U.S.A.)	VDE (Germany)
MQT8·11		J-44,J-46,J-129	E-104206	40007786
M3·M2·M2F		J-130, J-135	E-104206	40013485

NOTES: CMJ (Certification Management Council for Electrical and Electronic Components and Materials of Japan) is an established Japanese standard.

EM MATSUO

What is the Temperature Powerful Sensor (TPS)?

Applicable area for Each thermal device (Difference between Controller and Protector)

Positioning Chart of Various thermal device

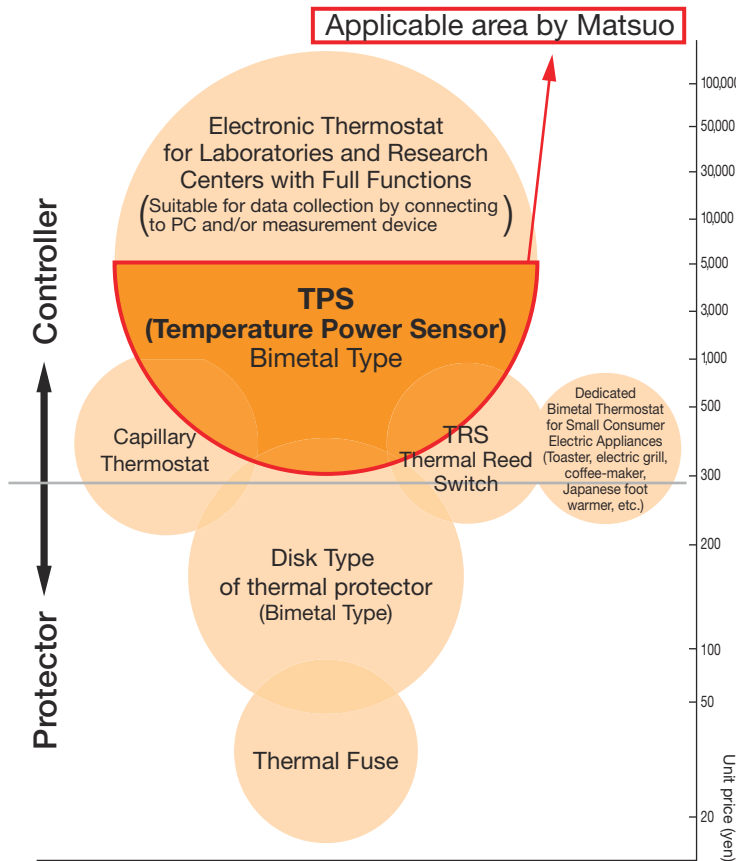

- Thermostat is a temperature switch that controls temperature in a specified range with a heater (heat source) or cooler (cooling device, fan) as load.
- A variety of thermal device includes electronic types, bimetal types, liquid expansion types, thermal reed magnetic force types, temperature fuses, etc..
- Two major functions of thermal device are controller and protector.

Controller

Thermostat used to maintain temperature in a specified range. The most common product is an electronic thermostat. Required characteristics are small ON/OFF temperature difference (differential), accuracy, long life, etc..

Protector

It is mainly used for the safety device of heaters, motors, etc.. This type of thermal protector is used as a safety device that cuts electric power when the temperature rises over the specified temperature. Generally, it accepts large differential and short life .

The chart above (Position for Various Thermostat) shows the positioning of six popular products.

The largest circle on top indicates the electronic thermostat's position.

Electronic Thermostat (for laboratories and research centers)

The representative controller is, not to mention, an electronic thermostat. However, the conventional electronic thermostat is expensive and used specifically for laboratories and research centers.

Temperature Powerful Sensor(TPS)

The TPS is comprised of a sharp snap spring which can be used semi-permanently, a flat bimetal free from material strain, and two flat bimetals for improving the sensitivity. As a result, the TPS can regulate temperature accurately, which is a replacement of the electronic thermostat.

Capillary Thermostat (liquid expansion method)

Most controllers had been this type before electronic thermostat was introduced to the market and had been utilized for both industry and consumer appliances. However, due to its large structure and the heat interference defect in the capillary tube, the number of applications seem to be decreasing.

TRS Thermal Reed Switch (magnetic type)

The problem is that the contact capacity is limited to less than 0.5A and that the contact does not snap or trip. Another problem is that this type of product is not suited for planned production because the temperature sensitive magnet is a burned component that makes it difficult to control additive elements and burning temperature to enable specific operation temperature ranges.

Disk Type of thermal protector

DISK (DISC) type of thermal protector is the general term for a sensor because of its shape. A single disk serves for temperature sensing and contact snapping. Because the structure is simple, it is inexpensive and most protectors are of this type. It is said that no alternative protector of different structure will be developed soon. However, this disk type of thermal protector has defects because its differential is large and specified temperatures gradually change because steel (non-spring material) is used for the contact and it must trip against large internal stress. Therefore, this structure cannot be used for a controller.

Thermal Fuse

As it is well known, thermal fuses cannot be used repeatedly. It is a primitive type of protector. Due to its simplicity and low price, demand for this safety device will continue.

Operating Principle of Temperature Powerful Sensor(TPS)

Bimetal thermostats for precise control applications specifically designed and built with miniaturization and low cost in mind. Each consists essentially of a spring, which has virtually indefinite service life and sharp, distinctive tripping characteristics, and a flat bimetal which is distortion free. Two pieces of bimetal are used in combination to increase sensitivity.

Shown below are the switching positions of the "X" type.

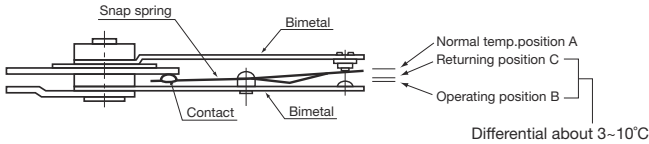

The narrow differential, sharp snap action spring plays an important role in achieving desirable thermostatic response. This snap spring turns on and off over an exceptionally small distance (approx. 0.05mm), or in terms of temperature, approx. 3°C Beryllium bronze snap spring can withstand at least 2 million operations.

Operating Principle of Disk Type of thermal protector

(Principle of operation)

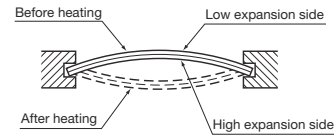

By forming a bimetal strip into a dome shape (hemispherical, dished shape) to acquire snap action, the disk type protector is characterized by its simplicity of construction. The simple design facilitates volume production and, because of its low cost, account for 80% of the entire bimetallic thermal protector market in the world.

(Sectional view)

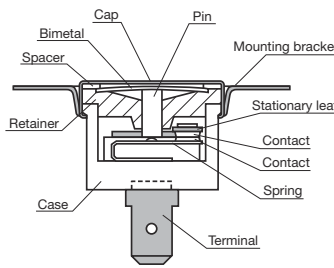

However, the bimetallic material has physical properties similar to ordinary steel material and is not a spring material in itself. During the course of repeated tripping, it is no wonder that just a strip of ordinary metal, formed into a dome, will progressively distort, or lose its shape, and return to its original shape of a flat strip.

The life of this style of thermal protector is generally limited to several thousand to tens of thousands of operations at best. Although they demonstrate almost ideal characteristics as protectors, they fall short of being qualified to serve as controllers.

Characteristics of Temperature Powerful Sensor(TPS) and Disk Type of thermal protector

		Matsuo thermostat (TPS)		Other manufacturers	
		Controller		Protector	
		Ordinary temperature	Middle temperature	High temperature	
Setting temperature		-10°C to 100°C	110°C to 200°C	200°C to 400°C	40°C to 230°C
Life*	Electrical	More than 100,000		More than 20,000**	Less than 10,000***
	Mechanical	More than 10,000,000		More than 10,000,000	Less than 10,000***
Differential (hysteresis)	A rank : 2 to 5°C	E rank : 10 to 20°C	F rank : 23 to 37°C	Aprox.10 to 20°C(setting Temp.40~100°C)	
	B rank : 3 to 6°C			Aprox.15 to 30°C(setting Temp.100~150°C)	
	C rank : 5 to 8°C			Aprox.20 to 40°C(setting Temp.150~230°C)	
	D rank : 8 to 12°C			There is no classification like A,B,C,D,E & F	
Rated load (resistive)	MQT model : AC125V/2A	AC125V/3~5A	AC125V/50mA	AC125V/15A	
	M2,M3 model : AC125V/5A				
Contact type (to be specified on order)	ON or OFF on rise		OFF on rise	ON or OFF on rise	
	ON or OFF on fall				

TPS stands for Temperature Powerful Sensor

Matsuo thermostat: *Guaranteed cycles without drift by Matsuo thermostat

** Guaranteed cycles without drift except higher setting temp. than 300°C

Other manufacturers *** The drift will start from the beginning



Glossary of Thermostat Terms

•Differential
Means ON/OFF temperature difference (also called Hysteresis).





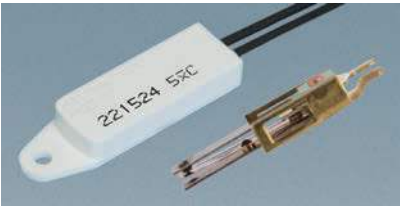

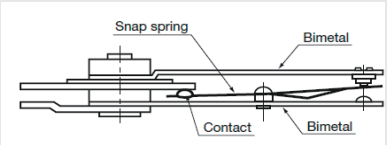
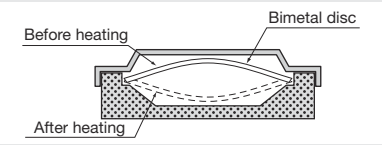
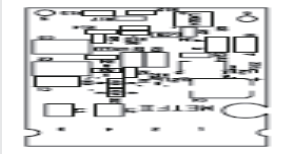



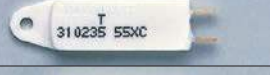

•Tolerance
Means an acceptable range in temperature, expressed as OFF point: 30°C±3°C
Differential: 3-6°C

Difference between Temperature Powerful Sensor(TPS) and Disk Type of thermal protector

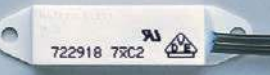
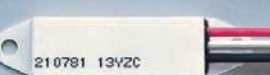
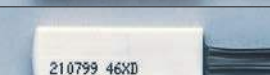
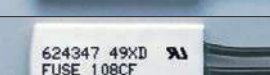



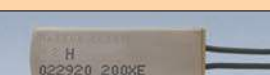

Comparison table

	TPS(Controller)	Disk(Protector)	Electronic(Controller)
Model			
Principle of operation			
Configuration	Dual flat bimetal with a snap spring assembled by hand.	Dome shaped bimetal made by stamping machine.	Thermister + Processing Circuit
Mechanical characteristics	Sharp action switching by a snap spring. Stress free switching is executed by a spring type of flat bimetal.	Ordinary steel material dome shaped bimetal accumulates mechanical stress at the edge of the dome.	N/A
Life(Mechanical)	Long life: 10 million cycles	Short life: 2,000 ~ 10,000 cycles	Long life: 10 million cycles
Tolerance	±1.5K	±5K~±8K	±1.0K
Accuracy	±0.2K(Repeatability)	±5K~±8K	±0.1K
Stability	Setting temperature does not move during its life cycles	Setting temperature moves toward the lower side during its life cycles	Setting temperature does not move during its life cycles
Differential	Selectable Rank A : 2~5K Rank B : 3~6K Rank C : 5~8K Rank D : 8~12K	Not selectabl 10~40K	Selectable 0.5K increment
FIT (Failure In Time)	Number of pieces failed per 1 billion hours. FIT = 3 Failure rate = 0.00025%	Not applicable due to protector Unknown failure rate (Very high)	FIT = 300 to 3000 Failure rate = 0.025 to 0.25%
Size	Compact	Compact	Big
Application	Temperature regulating Semicon. manufacturing equipment Semicon. Testing equipment. Ultrasonic diagnostic equipment Anti-fog, frost, freezing or fans Surveillance camera lenses Out door money exchangers Road snow melting systems Console box ADSL for internet Mobile phone ground stations Many other industries	Power shut down for over heating Basically, power shut down is the only application for Protector.	Same applications as the TPS but limited use due to its size.
Number of manufacturer	Only 1 company (Matsuo)	More than 1,000 to 2,000 companies	More than 100 to 200 companies
Who is our customer?	1. From 1 to 100,000 pcs per order 2. High quality, high valued equipment 3. Industrial use Semiconductor industry Telephone & internet industry Risk control industry Medical industry Transportation industry Other industries	1. From 10,000 to 1 mil. pcs per order 2. Low quality, low valued equipment 3. Home appliance use 4. Industrial use (limited) Motor Transformer Over-heat protection for other equipment	1. From 1 to 100,000 pcs per order 2. High quality, high valued equipment 3. Home appliance and industrial use Semiconductor industry Telephone & internet industry Risk control industry Medical industry Transportation industry

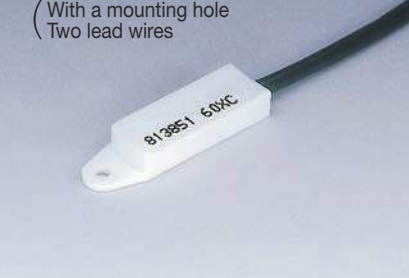
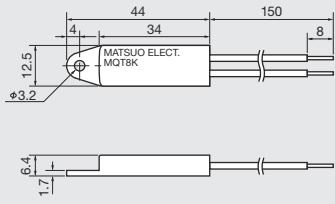
■ Selection Guide ■

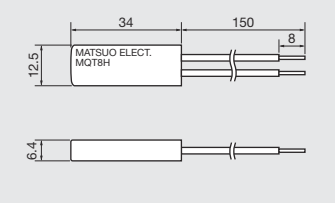
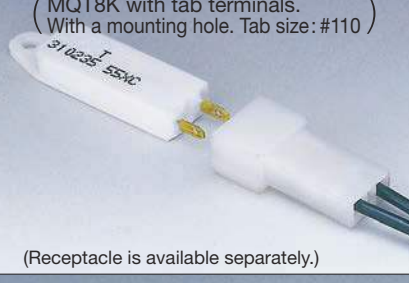
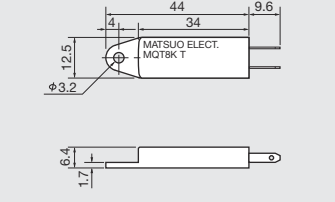
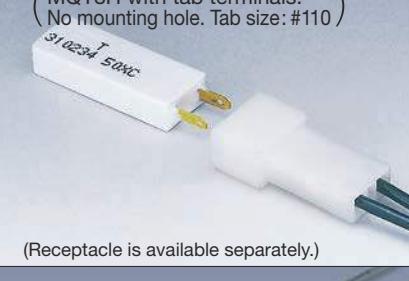
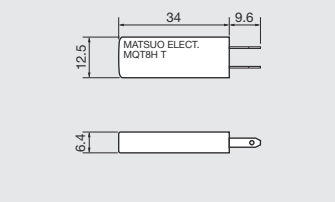
Temperature Power Sensor (Controller)	2 Amp. series for ordinary temperatures (AC125V/2A / AC250V/1.3A) [-10°C~110°C] Double seal type (DS) is available for all models.		
	MQT8K		Standard model of the 2 Amp. series. With mounting holes. With a 150mm lead.
	MQT8H		Same as 8K, but without the mounting hole. With a 150mm lead.
	MQT8KT		} With a #110 tab. } A receptacle with two holes (female housing) is provided. } Receptacles can be used separately for each terminal.
	MQT8HT		
	MQT11K MQT11H		11K and 11H consist of built-in fuse for dual safety. (The photo is 11H)
	MQT8H(DS)		Same as MQT8H, but double-sealed with another vinyl tube covering for improved waterproofing and anti-shock performance.
	5 Amp. series for ordinary temperatures (AC125V/5A / AC250V/3A) [-10°C~110°C] Double seal type (DS) is available for all models.		
	M3		Standard 5 Amp. Series with 2 mounting holes. With a 150mm lead.
	M3(Z)		It is an M3 type with a back contact. The external shape is the same with three 150mm leads (white, black and red).
	M2		Thin version of the 5 Amp. series. The differential is approximately 10°C. Long life model. Without a mounting hole. With a 150mm lead.
	M2F		Fail-safe design with a built-in fuse in the series with M2.
	MQT5S		Sealed in a vinyl tube. A back contact model (with 3 lead wires) is also available.
	Liquid Temperature Control Thermostat		
	MQT81P 2A type		It is a completely sealed thermostat which is screwed into a threaded hole on the side of a liquid tank. While the inside of the tank is waterproof, the lead section is not. For a PT3/8" screw. The body is made of brass and 304 stainless steel.
	MQT72P 5A type		It comes with a DIN connector which is screwed into a threaded hole on the side of a liquid tank. For a PT3/4" screw. The body is made of brass.
	MQT83P 2A type		It is a type that is inserted from the top of the tank. The body is made of 304 stainless steel.
	TPS for mid and high temperature (AC125V/3A / AC250V/2A) [110°C~400°C]		
	M2H		This is a thin version of the 3 Amp., and control from 110°C~200°C. With a 150mm lead.
	M2HA		Control from 200°C~400°C.

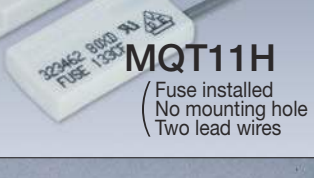
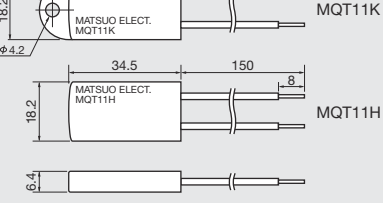
Each model is available in a double sealed construction.

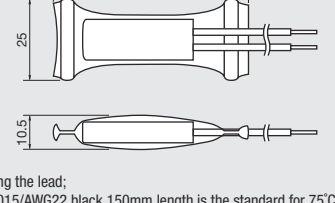
<p>MQT8K (With a mounting hole Two lead wires)</p> 	 <p>Regarding the lead; AWM1015/AWG22 black 150mm length is the standard for 75°C or lower AWM3271/AWG22 gray 150mm length is the standard for 76°C or higher</p>	<p>Features:</p> <ol style="list-style-type: none"> 1.) Representative model of the 2Amp. series. 2.) Epoch making low price for a long life and small differential thermostat. 3.) It can be mounted with only one screw. <p>It is most suitable for outside air temperature detection.</p> <p>Specification Data Sheet</p>
<p>MQT8H (No mounting hole Two lead wires)</p> 	 <p>Regarding the lead; AWM1015/AWG22 black 150mm length is the standard for 75°C or lower AWM3271/AWG22 gray 150mm length is the standard for 76°C or higher</p>	<p>Features:</p> <ol style="list-style-type: none"> 1.) It is suitable for insertion into heater pads, etc. 2.) The internal structure is the same as MQT8K.
<p>MQT8KT (MQT8K with tab terminals. With a mounting hole. Tab size: #110)</p>  <p>(Receptacle is available separately.)</p>	 <p>The terminal is #110, Faston</p>	<p>Features:</p> <ol style="list-style-type: none"> 1.) MQT8K with a tab terminal. 2.) Install a lead of your desired length into the receptacle and use it by inserting the thermostat. 3.) We have the receptacle available.
<p>MQT8HT (MQT8H with tab terminals. No mounting hole. Tab size: #110)</p>  <p>(Receptacle is available separately.)</p>	 <p>The terminal is #110, Faston</p>	<p>Features:</p> <p>The usage is the same as MQT8KT. The only difference is that it has no mounting hole.</p>
<p>MQT11K (Fuse installed Two lead wires With a mounting hole)</p>  <p>MQT11H (Fuse installed No mounting hole Two lead wires)</p> 	 <p>Regarding the lead; AWM1015/AWG22 black 150mm length is the standard for 75°C or lower AWM3271/AWG22 gray 150mm length is the standard for 76°C or higher</p>	<p>Features:</p> <ol style="list-style-type: none"> 1.) Cases of MQT8K and 8H are widened and temperature fuse is connected in series inside the case for dual safety. 2.) Standard specifications for the fuse temperature is 76°C/108°C/115°C/133°C/145°C. 3.) As for the fuse temperature, select the one with a temperature 25°C or more higher than the preset temperature of the thermostat.
<p>MQT8H (DS) Double sealed construction</p> 	 <p>Regarding the lead; AWM1015/AWG22 black 150mm length is the standard for 75°C or lower AWM3271/AWG22 gray 150mm length is the standard for 76°C or higher</p>	<p>Features:</p> <ol style="list-style-type: none"> 1.) While a near complete sealing is achieved by double sealing (DS), moisture intrusion by capillary action at the tip of the lead cannot be avoided. Be careful not to have water splash on the lead tip.

NOTE: All drawings are 40% of full size to help you compare the sizes of products.

Ratings and Characteristics:

Tolerance of Setting Temperature and Differential vs. Setting Temperature

Setting Temperature	-10°C~-1°C		0°C~50°C		51°C~59°C		60°C~65°C		66°C~75°C		76°C~100°C	
Diff. Contact configuration	X	Y	X	Y	X	Y	X	Y	X	Y	X	Y
A (2°C~5°C)	/		±3	±3	/		/		/		/	
B (3°C~6°C)	±4	±4	±3	±3	±4	±4	±4	±4	/		/	
C (5°C~8°C)	±4	±4	±3	±3	±4	±4	±4	±4	±5	±5	/	
D (8°C~12°C)	±4	±4	±4	±4	±4	±4	±4	±4	±5	±5	±5	±5

Note: 1. Above list shows the standard tolerance.
 2. Special tolerance such as ±1.5 or ±2 will be available.

Table of contact capacity by voltage used and by DIFF. ranking (100,000 times life as standard)

Voltage		Current		Standard contact		Crossbar contact (For micro current)	
		Differential rank	Current(unit power factor 1)	Differential rank	Current(unit power factor 1)		
AC250V	DC24V	A	50mA ~ 0.6A	A	1mA ~ 50mA		
		B	50mA ~ 0.9A	B			
		C	50mA ~ 1.3A	C			
		D	50mA ~ 1.3A	D			
AC125V	DC12V	A	50mA ~ 1A	A	1mA ~ 50mA		
		B	50mA ~ 1.5A	B			
		C	50mA ~ 2A	C			
		D	50mA ~ 2A	D			

NOTE: 1. "2 Ampere series" represents the standard maximum current at AC125V.
 2. A fluctuation by the unit power factor a half of the current at unit power factor by 0.75 power factor, 1/5 of the current at unit power factor by 0.4 power factor.
 3. The spark killer might be required for a load in direct voltage.

- Maximum operating voltage : AC250V max., DC24V max.
- Temperature setting range : -10°C~110°C (tolerance/differential will change in the higher temp.)(see the above table)
- Differential : rank A 3.5 ± 1.5 (2~5)°C
 rank B 4.5 ± 1.5 (3~6)°C
 rank C 6.5 ± 1.5 (5~8)°C
 rank D 10 ± 2 (8~12)°C
- Contact configuration : 1b(X), or 1a(Y)
- Operating temperature : -30°C~85°C(standard), -30°C~125°C(special)(no icing, no condensing)
 range (use within 60°C above the set temperature.)
- Insulation resistance : 100MΩ or more
- Contact resistance : 70mΩ or less (including lead wire resistance)
- Withstanding voltage : AC2000V for 2sec.(600V for 1minute between contacts)
- Vibration resistance : Selected from JIS·C·0911-1984
 Constant vibration; 50Hz fixed/0.2mm fixed (1G)
 Sweep vibration; 10~55Hz/0.35mm fixed (0.1~2.2G)
 Withstands 2 hour each in directions X, Y and Z.
- Impact resistance : No damage when dropped three times from the height of 40cm onto a concrete floor(about 70G).
 No damage for double sealed model when dropped three times from the height of 1m onto a concrete floor (about 240G).
 Withstands substantial impact after being put in a package or mounted in equipment.
- Life : 2 million mechanical operations, 100,000 electrical operations at rated load.
- Handling precautions : The thermostat withstands vibration and impact applied along Y and Z axis, but does not tolerate impact from X direction. It is recommended that the thermostats be installed to minimize stresses applied along the X axis.

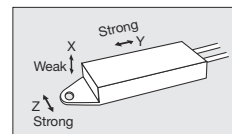

Tab terminal series

A #110 tab comes out from the thermostat main body, and a dedicated receptacle of a double pole combined type is prepared as the corresponding receptacle.

Because the conventional type with a lead could not adapt itself to lead length cases different from the standard lead length (150mm), we changed it so that the customer can freely select the lead length, which is a big improvement.

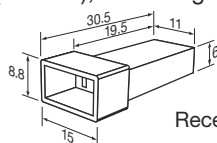

Receptacle dimensional drawing

*It is expected that the customer will make the connection of the lead, with the length required by the customer, and the female housing.

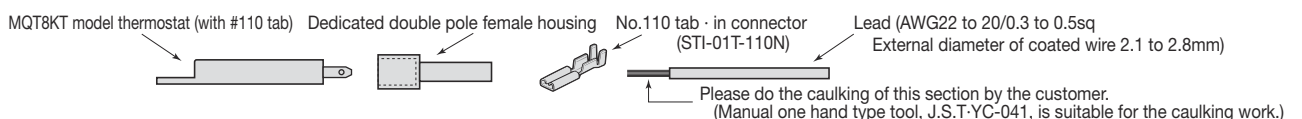

NOTE: Because No.110 tab-in connector comes in a reel, connection by an automated machine is possible.

Internal Heat Generation vs. Load

Contact capacity is limited for electrical components such as relays, thermostats or switches with make and break contact, because the contacts generate heat. Since a thermostat, in particular, reacts to temperature change, the heat generated at the contacts affects its operating temperature and differential. Matsuo's thermostats, as seen in the graph, have sufficient current capacity with an ample margin for the heat generated by the contacts.

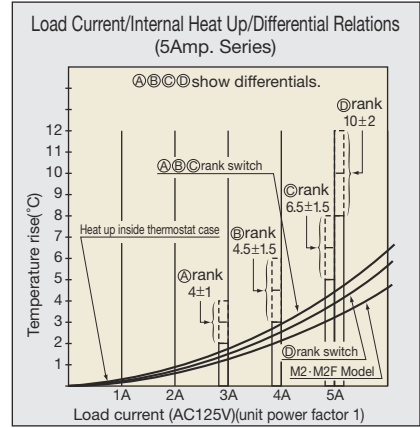
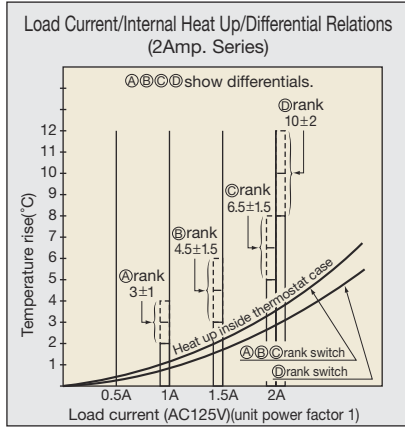

Relation between Life and Load

Temperature Power Sensor, TPS can perform more than 10 million mechanical operations. However, under heavy loads, the life will be reduced due to the wear of contacts. A life of 100,000 cycles of operation is guaranteed at the rated load current. Under reduced loads, the life lasts longer. See the graph on the right.

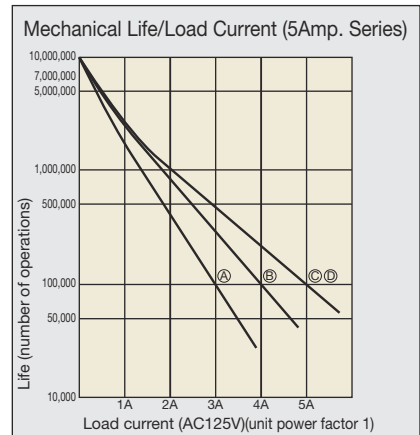
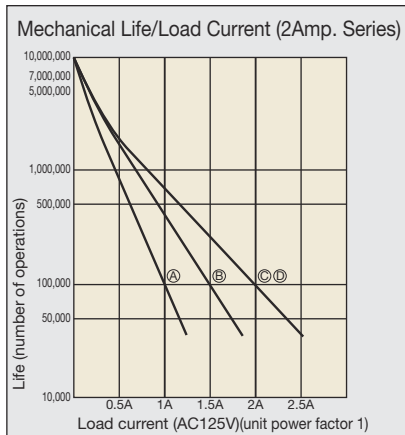

"Heat Time Constant" of Temperature Power Sensor

Any object has its own heat capacity. Generally, large objects do not easily assimilate with ambient temperature, on the other hand small objects do. Moreover, objects with good heat conductivity assimilate easily, and objects with small heat conductivity do not easily assimilate. Assimilation with ambient temperature is expressed by a "Heat Time Constant".

We measured the "Heat Time Constant" of the MQT8 Series Temperature Power Sensor.

"Heat Time Constant" (expressed by time to reach 60% of the range of temperature change) are the same as indicated in the chart to the left, regardless the range of temperature change, if the material and measurement conditions are the same.

The "Heat Time Constant" is 102 seconds for the MQT8 series, 160 seconds for the M2, and 195 seconds for the M3 when the device is measured under 1 to 1.5m wind speed, respectively.

As water takes heat from objects faster than air, the "Heat Time Constant" measured in water is smaller than that measured in air.

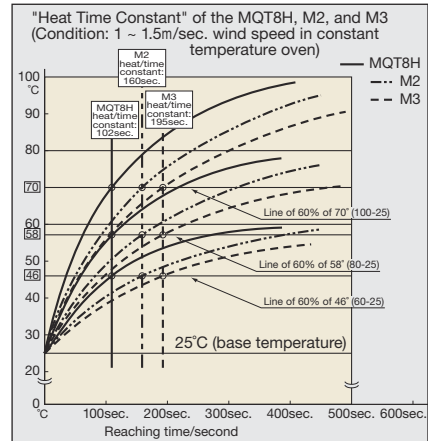

Practical Heat Capacity Measurement

A heat/time constant is reasonable indicator in precisely grasping the heat capacity of an object. However, it is too academic. The following chart may help you see how the temperature of thermostats assimilates with the changing ambient temperature.

If the ambient temperature changes faster, the thermostat's affiliation for the ambient temperature is delayed. On the other hand, if it changes slowly, the thermostat can follow the ambient temperature change.

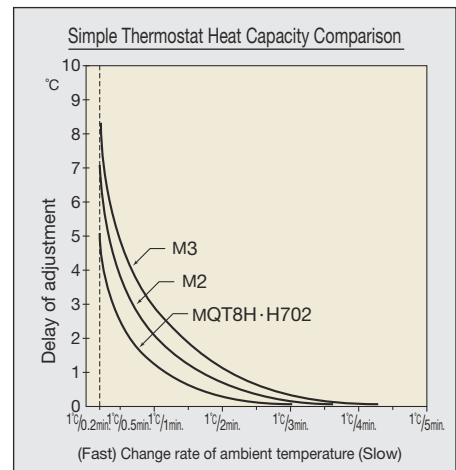

Something to be considered when using a Thermostat with DC Voltage Circuits

1.)The thermostat contacts may be damaged by arcs. How the damage occurs is affected by four factors as follows:
Because the Temperature Power Sensor is small in size, the contact gap (distance between the two contacts) cannot be made large. The standard is 0.1 mm. However, this Sensor has a sharp cut off mechanism and restores the 0.1 mm gap instantaneously.

(a) Voltage

Voltage is reflected by the contact gap. We ensure up to 250V AC or 48V DC (using a spark killer).

(b) Current

The current level mainly relates to what extent the contact is damaged by an arc, not whether the arc is disconnected or not. Because the arc of a high current causes rapid heating to the contact, adverse effects such as early contact melting or surface oxidization of the contact may occur.

(c) Open and close speed of the contact

If the gap between two contacts increases up to 0.1 mm instantaneously, the arc will be easily disconnected. However, if its action is slow, the contact will be damaged faster

because it is kept heated until the gap becomes large enough to disconnect the arc.

(d) Quality of the contact material and the condition of the contact surface
If the contact is damaged and any projection is created (shown on the left), the arc will not be easily disconnected.



2.)As you know, when the contact opens, the arc continues for DC, but easily disconnects for AC. On the other hand, for AC, the phase of voltage alternates every 1/50 to 1/60 of a second, so that any accident in which an arc is drawn does not occur. As DC always runs in one direction, the arc is not easily disconnected.

3.)What does "a contact is damaged" mean exactly?

The surface or fringe of the contact is often contaminated by carbon created by the spark or arc when the contact is activated. Deposits of carbon increase contact resistance between the two contacts. A larger resistance naturally causes heating of the contact and carbon deposition becomes more likely. In addition, the current decreases, and the temperature of the load heater does not easily rise.

Cross Bar Contacts (Micro Capacity Contacts)

For ordinary contacts, the maximum current is indicated as 2Amp. max. etc. What is the minimum current? This is generally around 50~100 mA. Currents below this range are covered by special contacts for micro current.

The minimum current for ordinary contacts of our 2 Amp. series is also 50 mA. For currents below 50 mA, Crossbar contacts, called K contacts, are applied. Since the current range covered by cross contacts is 1~ 49 mA.

The structure of crossbar contacts is that of two noble metal contacts in trapezoidal shape, contacting with each other crosswise. The benefit of this structure is that there will be smaller possibility for contact failure because it can assure the large contact pressure per unit area.

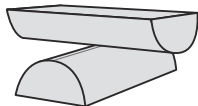

Contact Type Indication

As we manufacture thermostats to be used as controllers, their model designation is more complicated than is the case of protectors. Refer to the diagram on the right.

● Contacts which open when the temperature rises are designated as X, and those which close when the temperature rises are designated as Y. Shown in the diagram is the temperature at which the contacts operate when the temperature rises (the high temperature side). \bar{X} [Xbar] and \bar{Y} [Ybar] are used for contacts that operate when the temperature falls (the low temperature side). \bar{X} [Xbar] indicates the contact that closes when the temperature falls. \bar{Y} [Ybar] indicates the contact that opens when the temperature falls. Z indicates transfer contacts. XZ is the main contact that opens when the temperature rises. $\bar{X}Z$ [Xbar Z] is the main contact that closes when the temperature falls.

● C is the standard rank designation for X contacts and B is standard for Y contacts. Please consider X is C ranked and Y is B ranked, unless otherwise indicated.

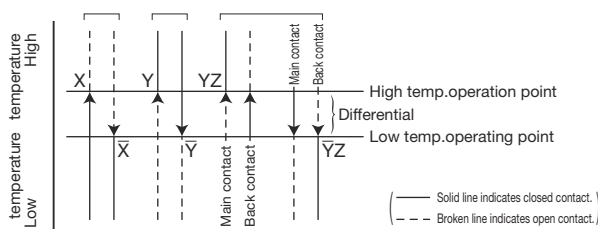

Model Designation Method

MQT8H K35XC represents a thermostat with crossbar contacts (K means crossbar contact).

For 5 Amp. Series with a back contact, a model name will be, for example, M3 35XZB, where Z means contact with the back contact.

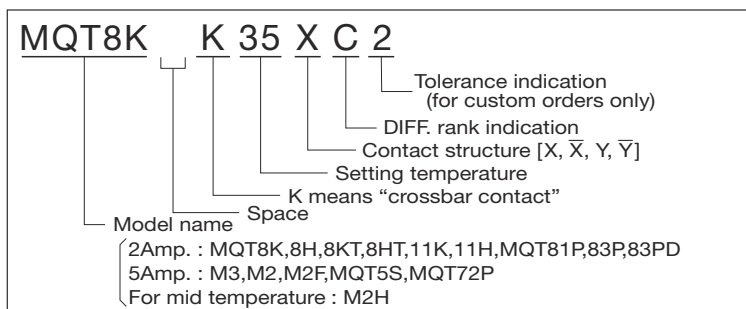

OPERATION TEMPERATURE DATA SHEET			
Model: MQT8H 30YB (VDE)			
Operating temperature Characteristics (°C)			
Sample No.	ON	OFF	DIFF.
	30 ± 3K		3 — 6
1	30.2	24.4	5.8
2	31.4	25.8	5.6
3	31.8	26.3	5.5
4	29.3	24.0	5.3
5	29.5	23.8	5.7
6	29.4	24.4	5.0
7	30.2	25.2	5.0
8	30.6	24.7	5.9
9	31.6	26.5	5.1
10	29.6	24.0	5.6
Statistical data	<p style="margin: 0;">Average ON: 30.4 °C</p> <p style="margin: 0;">Average OFF: 24.9 °C</p> <p style="margin: 0;">Average Diff: 5.5K</p> <p style="margin: 0;">Max deviation: +1.8°C (No.3)</p> <p style="margin: 0;">Temperature setting tolerance:</p> <p style="margin: 0; padding-left: 20px;">± 3K</p> <p style="margin: 0;">Repeatability:</p> <p style="margin: 0; padding-left: 20px;">± 0.2K</p>		

Performance of MQT8H 30YB

This data sheet shows you ON temperature and OFF temperature for 10 pieces of MQT8H 30YB.

Highest ON temperature:

Sample No.3 has the highest ON temperature among of these 10 pieces and its deviation from the setting temperature of 30°C is +1.8°C which is in the range of our standard tolerance of ±3K.

The contacts of sample No.3 will always switch ON at 31.8°C±0.2°C on temperature rise, and OFF at 26.3°C±0.2°C on temperature fall. Repeatability is ±0.2°C.

Each sample has own differential between 3 and 6K, and the differential value of this sample No.3 is 5.5K which is permanently fixed and not fluctuate at all.

Lowest ON temperature:

Sample No.4 has the lowest ON temperature among of these 10 pieces and its deviation from the setting temperature of 30°C is -0.7°C which is in the range of our standard tolerance of ±3K.

Life:

100,000 cycles guaranteed at our specified electrical rating shown below.

0.6A/AC250V, 1A/AC125V for diff. rank A.

0.9A/AC250V, 1.5A/AC125V for diff. rank B

1.3A/AC250V, 2A/AC125V for diff. rank C and D.

Smaller electrical rating makes longer life and mechanical life will be more than 10 million cycles.

Topics

- 1.)Housed in a compact closed case.
- 2.)Mechanical service life of 10 million operations and electrical service life of at least 100,000 operations, guaranteed.
At least 500,000 operations for 1/2, 1 million operations for 1/4 and 7 million operations for 1/20 of the rating, guaranteed.
- 3.)With the narrowest possible differential of about 3°C, the product finds a considerably wide application as a controller.
- 4.)Moreover, the price is attractive. It is several times cheaper than an electronic thermostat, although it substantially varies by quantity.
- 5.)FIT = 2 to 3
FIT (Failure in Time) is used to indicate the failure rate. The unit of FIT is how many failures occur in one billion hours. For example, when three failures occur in one billion hours, the failure rate (FIT) is 3.

Technical information (knowledge to design a good temperature control system)

1. Thermostats can be categorized into two groups, controllers and protectors. Please decide which one you want to use.

- Controllers are thermostats used to maintain temperature within a specified range.
- Protectors are thermostats used to cut electric power when the temperature rapidly rises and exceeds the specified limit.

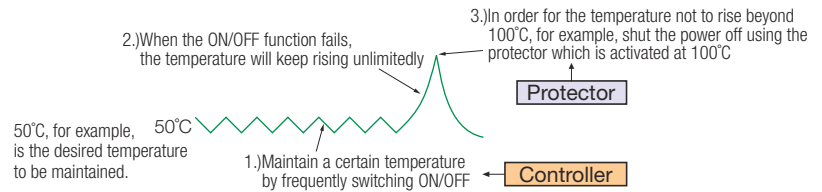

2. First, correctly understand the eventual purpose of yours temperature control, and then start studying the peripheral material.

- A thermostat controls a load such as the heater, motor, fan, lamp and so on, by sensing a change of temperature. If the thermostat may be affected by the ambient temperature, cover the thermostat with thermal insulation.

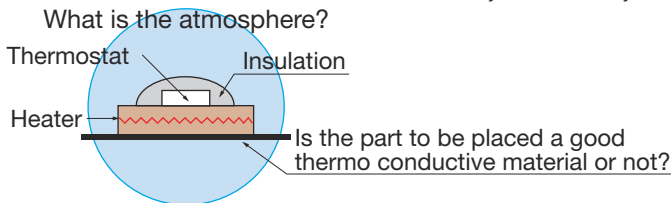

- The positional relationship between the thermostat and the heat source (heater or cooler) is important.

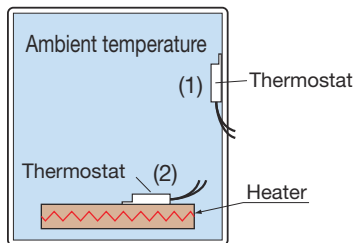

To control the ambient temperature within an enclosure, place a thermostat in position (2) in the figure. A thermostat installed in position (1) cannot provide proper temperature control.

- Determine the optimal differential.

When using a control-type thermostat such as the Temperature Power Sensor (TPS), a customer is likely to select a product grade with a small differential. This selection is the right choice answer in a sense, but this type of thermostat operates more frequently and may have a shorter service life.

The tip to configure your best temperature control system is to combine the mutually contradictory factors "accurate control and long life" appropriately.

3. Are you using a heater that is too big?

Are you using a heater that is too big in comparison to the heat capacity of the heated object just because you want to reach the desired temperature quickly? If this is the case, the heater will be operated many times, resulting in a shorter thermostat life, and maintaining the temperature will become unstable due to overshooting of the temperature. If you can wait a little longer for the initial temperature to rise, the life could be extended by three fold.

4. It is recommended that a surge protector using a capacitor/resistor be used to protect the thermostat from unfavorable phenomenon such as a surge or arc.

It is sold on the market under the name of "surge killer", "spark killer" or "arc killer". As for the installation method, it is usually installed in parallel to the contact. Try to install it as close to the contact as possible. Representative characteristic of the various loads are listed below by their structure. Give enough margin when designing a system.

- 1.) Resistive Load In- rush current $i / \text{rated current } i_o = 1$
- 2.) Incandescent lamp $i / i_o \approx 10 \sim 15$ times, about 1/3 sec
- 3.) Fluorescent lamp $i / i_o \approx 3$ times, within 10 sec
- 4.) Mercury lamp $i / i_o \approx 3$ times, about 3 to 5 minutes
- 5.) Motor and Fan $i / i_o \approx 5$ to 10 times, about 0.2 to 0.3 sec
- 6.) Solenoid $i / i_o \approx 10$ to 20 times, about 0.1 sec
- 7.) Electromagnetic conductor $i / i_o \approx 3$ to 10 times, about 1/30 sec
- 8.) Load of capacitor $i / i_o \approx 20$ to 40 times, about 1/30 sec

An experimental test might be necessary to determine the level of surge killer. If you send an actual load sample to us, we will perform a test on your behalf.

■ Technical information (TPS) ■

1. The TPS is an electric component and vulnerable to impact when it is alone.

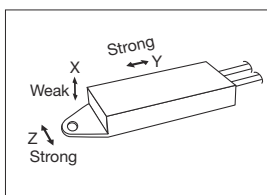

The TPS is delicate to impacts in the X direction and strong in the Y and Z directions (see the figure to the left). When a TPS is dropped from a height of 70 cm to the floor and it sustains an impact in the X direction, a temperature setting error between 2 and 3 may occur.

Once a TPS is integrated into your system, it isn't easily affected by extremely low impacts compared to when it is alone. This also applies to a TPS wrapped with corrugated fiberboard during delivery. Individual TPS wrapped with corrugated fiberboard must not be exposed to dangerous impacts.

In other words, extreme caution should be taken until a TPS is installed into your system after unpacking.

*In case you drop the TPS on the floor, please return it to Matsuo Electric for reinspection.

2. Double sealed construction (DS) ensures excellent waterproof and impact resistant performance.

Double sealed (DS) TPSs are sealed with vinyl tubes to improve waterproof and impact resistant performance. The DS type has an impact resistance of 240G.

3. Standard TPSs have a dripproof construction.

For standard TPSs, the thermostat is housed in a plastic case with its exits for the leads sealed with a sealant, ensuring dustproof and dripproof performance.

However, repeated material expansion and contraction, and internal air pressure changes caused by thermal cycles may lead to wear of the plastic case and sealant, which consequently deteriorates the sealing performance.

Also, pay attention to possible capillary action of the leads.

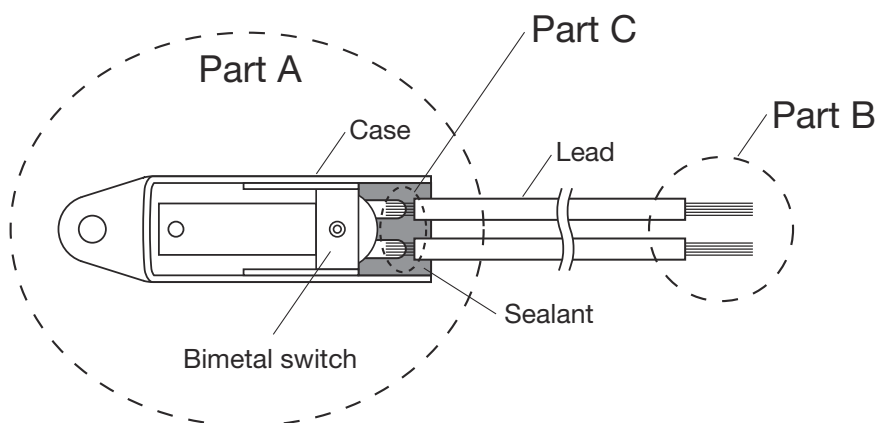

Part A has a dripproof construction.

However, if Part B is exposed to water, the water may come into Part C due to capillary action. Part C and its surrounding area are close to the bimetal switch body. Therefore, be careful not to expose Part B to water during use.

4. Storage conditions and period

When storing the product for an extended period of time, keep it in a sealed plastic bag as much as possible.

Always check the contact resistance before use.

Particularly, Type Y and others with the contacts wide apart require extra attention.

The storage period is about one year although it depends on the storage conditions.