

Flavus 2.4 / 5 GHz Snap-In Antenna

Product Specification

1 Features

- Designed for dualband 2.4/5 GHz applications
- Intended for Snap-In mounting
- Supplied in trays

2 Description

The Flavus antenna is a high performance antenna intended for use with Bluetooth and wireless LAN applications in both 802.11 a and b,g operations. The dual band functionality is well suited for use with dual band WLAN radio modules. The Flavus 2.4/5 GHz antenna has the same footprint and characteristics as the popular Flavus 2.4 GHz antenna from gigaAnt. This enables OEM's to keep the same antenna type through a whole product range. For Bluetooth and 802.11b applications, use the single band antenna and for products using 802.11a (5Ghz) or dual band, just switch to the new Flavus 2.4/5 with ease.

3 Application

- Industrial applications
- Network nodes
- Access points
- Portable PCs
- Wireless cable modems



Contents

1 Features	1
2 Description	1
3 Application	1
4 Model name	3
5 General data	3
6 Electrical characteristics	3
7 Electrical performance	4
7.1 Voltage Standing Wave Ratio	4
7.2 3D-Radiation	4
7.3 Radiation patterns	5
8 Antenna Dimensions	5
9 Antenna Footprint	6
10 Electrical interface	6
10.1 Transmission line and matching	6
10.2 Test board dimensions	7
10.3 Test board matching	7
11 Reliability	7
11.1 Temperature and Humidity	7
11.2 Mechanical	8
11.3 Miscellaneous	8
11.4 Judgement standard	8
12 Hazardous Material Regulation Conformance	8
13 Application example	9
14 Packaging	10
14.1 Shelf storage recommendation	10
14.2 Packaging characteristics	10
14.3 Tray dimension	10
14.4 Box dimension	10
14.5 Label information	10

4 Model name

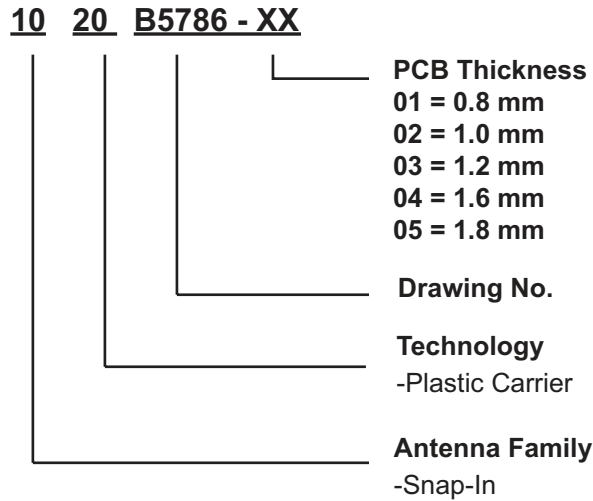

5 General data

Product Name	Flavus 2.4 / 5 GHz
Article No.	1020B5786-01..05
Frequency	2.4-2.5 GHz / 5.15 - 5.825 GHz
Polarization	Linear
Operating temperature	-40 to + 85 degC
Impedance	50 Ohm
Weight	0.6 gram
Antenna type	Snap-in

6 Electrical characteristics

	Characteristics		Conditions*
	2.4-2.5	5.15-5.825	
Peak Gain	4.0 dBi	3 dBi	Measured in 3D chamber (near field)
Efficiency	60%	70%	
VSWR	<2:1	<2:1	Measured in Network Analyzer

*Note all data provided in this table are based on the gigaAnt reference board

7 Electrical performance

7.1 Voltage Standing Wave Ratio

2.4-2.5 GHz

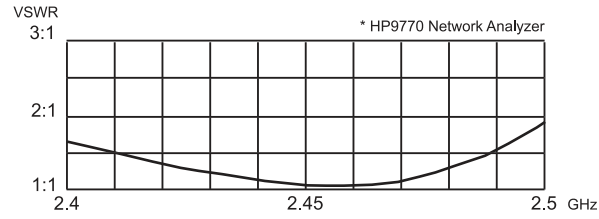

5.15-5.825 GHz

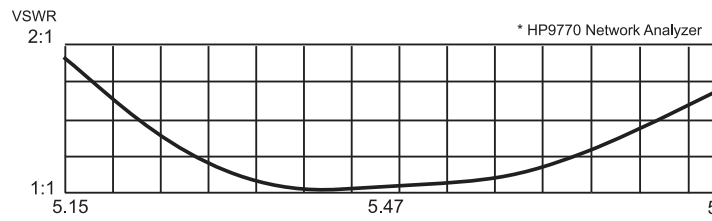

7.2 3D-Radiation

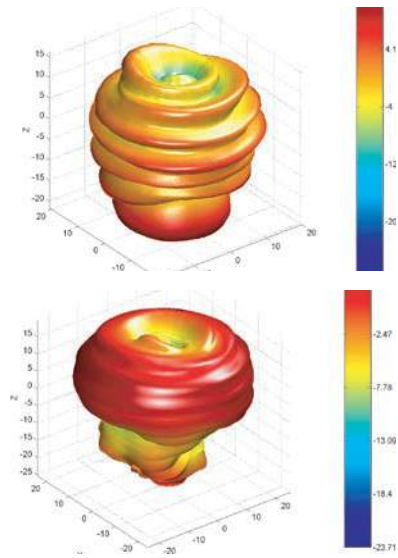

7.3 Radiation patterns

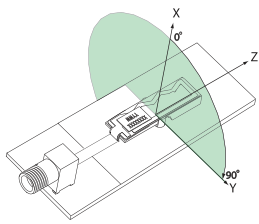

XY- Plane

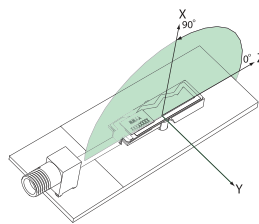

XZ- Plane

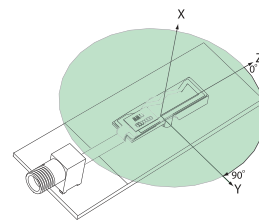

YZ- Plane

2.4-2.5 GHz

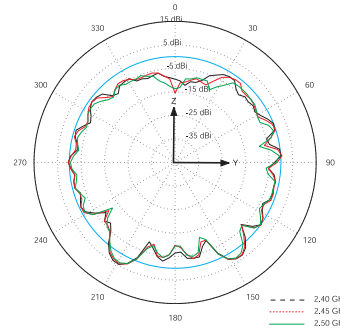
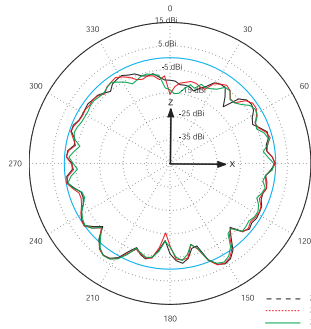
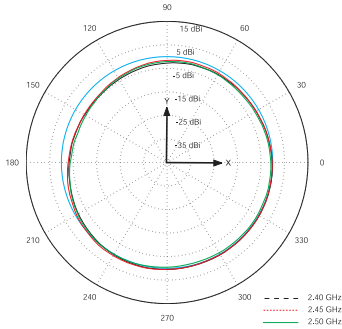

5.15-5.825 GHz

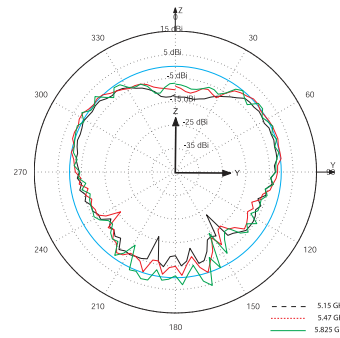
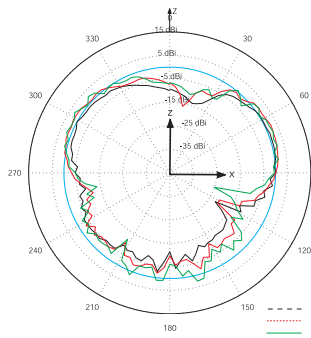
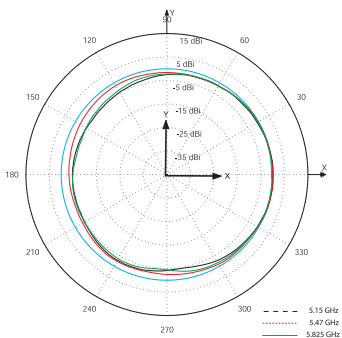

8 Antenna Dimensions

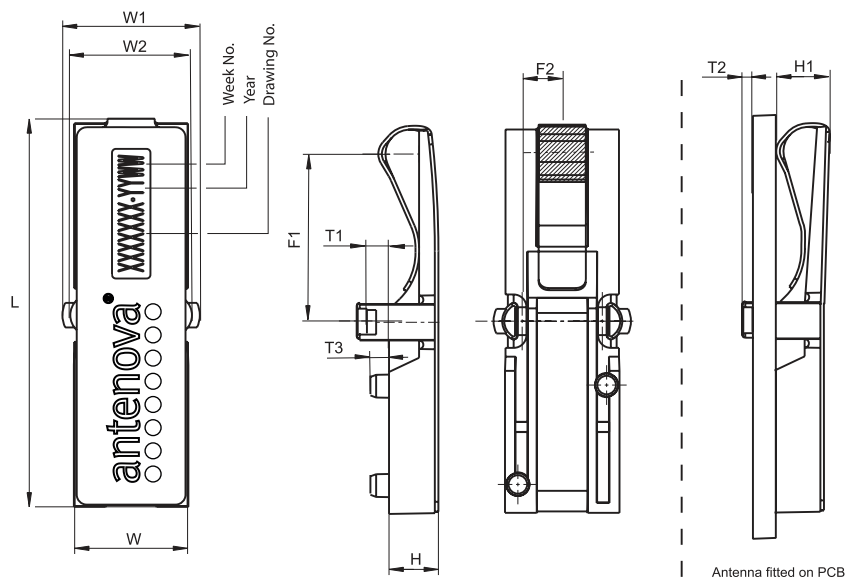

L	W	W1	W2	H	H1	F1	F2	T1	T2	T3
Length	Width	Width	Width	Height	Height	Feed	Feed	PCB		
27.3 ±0.2	7.9 ±0.2	9.6 ±0.2	8.5 ±0.2	3.45 ±0.1	3.85 ±0.1	11.85 ±0.2	2.8 ±0.1	T1 ±0.05	1.35 ±0.2	1.3 ±0.1

Dimensions in millimeters

9 Antenna Footprint

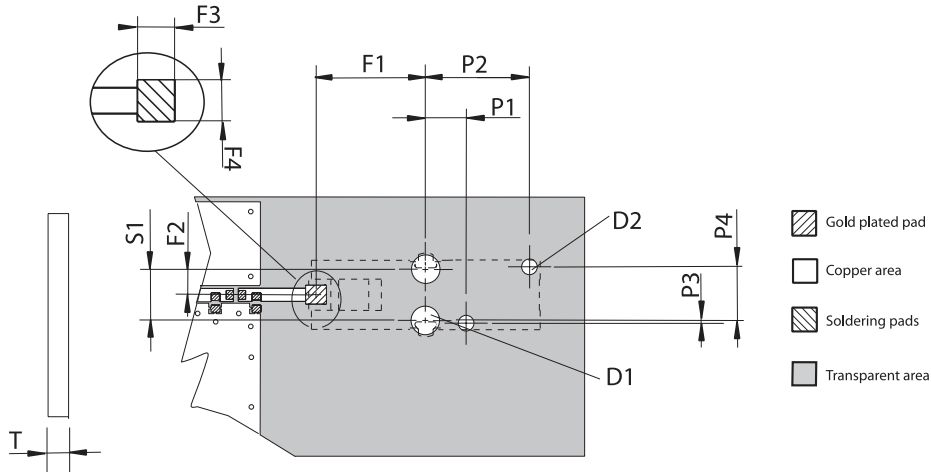

F1	F2	F3	F4	S1	P1	P2	P3	P4	D1	D2	T*
Feed	Feed	Feed	Feed	Snap-In	Position	Position	Position	Position	Diameter	Diameter	PCB
11.85 ±0.1	2.8 ±0.1	2 ±0.05	2.25 ±0.05	5.6 ±0.1	4.5 ±0.1	11.5 ±0.1	0.3 ±0.1	5.9 ±0.1	3.05 ±0.1	1.75 ±0.1	0.8, 1.0, 1.2, 1.6, 1.8

Dimensions in millimeters

10 Electrical interface

10.1 Transmission line and matching

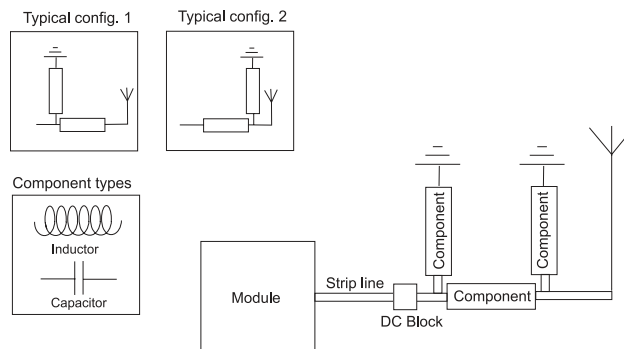

The matching network has to be individually designed using one, two or three components.

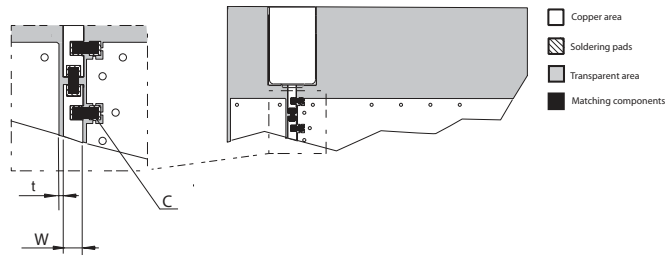

t, w = Unique dimensioning according to your PCB *

C = Inductor and capacitor values according to your specific device*

* Antenova provides this service upon request

10.2 Test board dimensions

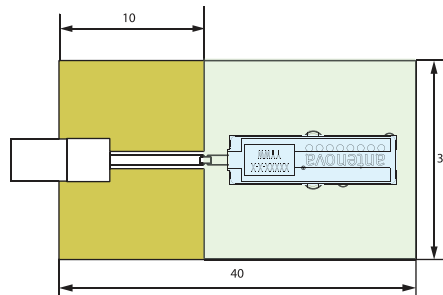

The testboard is designed for evaluation purposes for Flavus antenna. The card has the same size as a typical PCMCIA card and is fitted with an SMA connector.

10.3 Test board matching

The testboard requires no external matching.

Note! External components could be used in implementations due to size of PCB board, surrounding components etc.

11 Reliability

11.1 Temperature and Humidity

Item	Standard	Low	High	Duration
Operating temperature	EN/IEC 60068-2-2, Test Bd: Dry heat	-30 degC	+90 degC	-
Temperature cycling	EN/IEC 60068-2-14, Test Na: Change of temperature	-30 degC	+90 degC	100cycles / 10min
Storage life Humidity	EN/IEC 60068-2-1, Test Ca: Damp heat	+40 degC / 93% RH		96 h
Storage life Low temperature	EN/IEC 60068-2-1, Test Ad: Cold	-25 degC	-	200 h
Storage life High temperature	EN/IEC 60068-2-2, Test Bb: Dry heat	-	+ 90 degC	1000 h

11.2 Mechanical

Item	Standard	Specification	Duration
Contact force		Antenna is mounted on reference board. and a pressure gauge is applied to antenna contact.	
Drop test		Dummy weight: 150g Height: 170cm	One drop at each side, total drops: 6
Vibration	EN/IEC 60068-2-6, Test Fc (sinusoidal)	Acceleration spectral density:10-1000Hz Acceleration: 20m/s ² Number of axes: 3 mutually perpendicular	5 cycles per axis

11.3 Miscellaneous

Item	Standard	Specification	Duration
Contact pad Corrosion	ASTM B117	SO ₂ Concentration: 25 ppm Temperature : 25 Deg C RH: 93%	96 hours

11.4 Judgement standard

The judgement of the above tests should be made as follows:

1. Visual inspection - Normal appearance with no obvious deformation
2. Electrical inspection - The antenna satisfies the VSWR specification throughout the GSM band
3. Mechanical inspection - Acceptable contact force min. 0.5 N

12 Hazardous Material Regulation Conformance

Cadmium and cadmium compound.

Organic brominated compound (PBB, PBDE)

Polychlorinated biphenyl (PCB)

Polychlorinated naphthalene (PCN)

Organic tin compound

Asbestos

Azo compound

Lead and lead compound

Mercury and mercury compound

Sesivalent chrome compound

Chlorinated paraffin (CP)

Mirex

Formaldehyde

Tetra-bromo-bisphenol-A-bis (TBBP-A-bis)

13 Application example

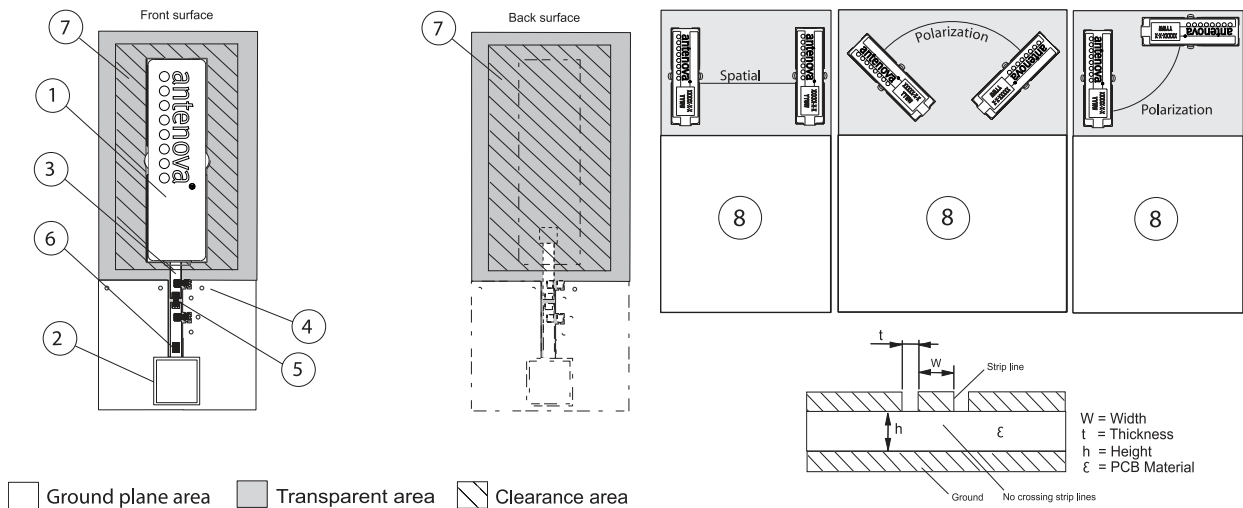

Fig. 1

1. Placement of antenna

The antenna shall preferably be placed at the edge of the PCB oriented as above. Other placements and orientations and size of groundplanes are possible, but will affect the performance. Avoid active components near the antenna.

2. Placement of GSM module or radio

To avoid losses the module shall be placed as close to the antenna as possible.

3. Strip line

The strip line must be dimensioned according to your specific PCB. (see Fig 1). No crossing strip lines are allowed between the strip line and its ground plane.

4. Via connections

To avoid spurious effects, via connections must be made to analogue ground.

5. Component matching

Component values are depending on antenna placement, PCB dimensions and location of other components.

6. DC Block

Might be needed depending on RF Module configuration.

7. Clearance area

Avoid components and parts close to the antenna.

8. Diversity

The antenna should be arranged to maximise the diversity effect. This could be done by separating the antennas as far as possible and place them perpendicular to each other.

**Note ! Incorrect implementation of the antenna will affect the performance.
Contact Antenna for implementation services.**

14 Packaging

14.1 Shelf storage recommendation

Temperature	-10 to +40 degree C
Humidity	Less than 75% RH
Shelf Life	12 Months
Storage place	Away from corrosive gas and direct sunlight

14.2 Packaging characteristics

Quantity	Number of trays	Tray quantity
840 pcs / box	6 / box	140 pcs

14.3 Tray dimension

Material: Anti static plastic tray
 Width [mm] W: 290
 Breadth [mm] B: 390
 Height [mm] H: 14

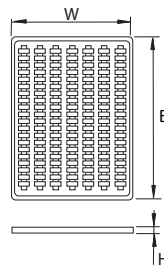

14.4 Box dimension

Material: Paper
 Width [mm] W: 296
 Breadth [mm] B: 396
 Height [mm] H: 75

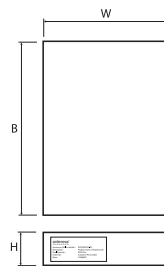

14.5 Label information

Antenva Article number :	XXXXXXX-XX
Description :	Product name, Frequency Hz
Reel Quantity :	XXXX Pcs.
Order No:	Customer PO number
Date:	YYMMDD



www.antenova.com

Corporate Headquarters

Antenova Ltd.

Far Field House
Albert Road
Stow-cum-Quy
Cambridge
CB9 5AR

Tel: +44 (0) 1223 810600
Fax: +44 (0) 1223 810650
Email: info@antenova.com

Asia Headquarters

Antenova Asia Ltd.

3F, No 10, Alley 6, Lane 45
Poa Shing Road
Hsin Tien City
Taipe County
ROC 23145

Tel: +886 (0) 2 2917 6536
Fax: +886 (0) 2 2910 6546
Email: info@antenova.com

Sales Offices

Europe

Charlotta Olander

UK/EU Sales Manager

Tel: +46 702 913731
Email: Lotta.Olander@antenova.com

America

David Nuti

NA Sales Manager

Tel: +1 214 668 0357
Email: David.Nuti@antenova.com

Asia

CL Lim

VP Sales Asia

Tel: +886 (0) 931 201 318
Email: CL.Lim@antenova.com



Certificate No: 4598/04

Integrated Antenna Solutions