

Common mode filters/Chokes

Automotive signal line (for power train/safety)

ACT series



AEC-Q200

ACT1210 type



FEATURES

- Compact products (3225 size), whose characteristics are equivalent to that of conventional products (ACT45B, ACT45R).
- Common mode choke for CAN-BUS/FlexRay, compatible with an operating temperature range of -55 to $+150^{\circ}\text{C}$.
- Operating temperature range: -55 to $+150^{\circ}\text{C}$
- Compliant with AEC-Q200

APPLICATION

- CAN-BUS, FlexRay system.

PART NUMBER CONSTRUCTION

ACT1210	-	110	-	2P	-	TL	00
Series • type name		Inductance(typ.) (μH)		Number of lines		Packaging style	Internal code

CHARACTERISTICS SPECIFICATION TABLE

Common mode impedance		Common mode inductance	Stray inductance	DC resistance	Rated current	Insulation resistance	Rated voltage	Part No.
[10MHz 100mV] (Ω)min.	(Ω)typ.	[100kHz 100mV] (μH)+50/-30%	[100kHz 100mV] (μH)typ.	(Ω)max.	(mA)max.	(M Ω)min.	(V)max.	
300	550	11	0.05	0.4	300	10	80	ACT1210-110-2P-TL00
500	1100	22	0.06	0.5	250	10	80	ACT1210-220-2P-TL00
1000	2600	51	0.09	0.7	200	10	80	ACT1210-510-2P-TL00
2200	5100	100	0.13	1.5	150	10	80	ACT1210-101-2P-TL00

Derating

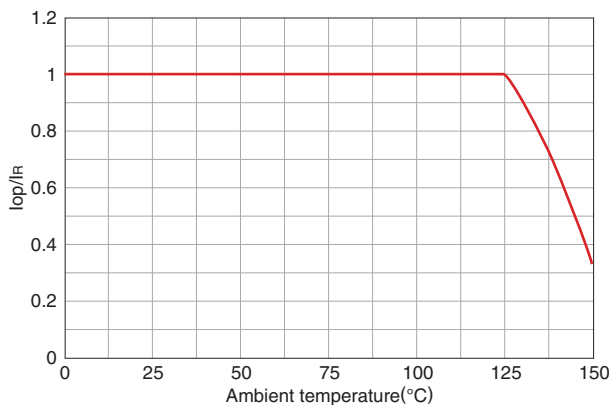

Maximum current value for the ambient temperature (mA)

Part No.	Ambient temperature		
	125 $^{\circ}\text{C}$	140 $^{\circ}\text{C}$	150 $^{\circ}\text{C}$
ACT1210-110-2P-TL00	300	200	100
ACT1210-220-2P-TL00	250	166	83
ACT1210-510-2P-TL00	200	133	66
ACT1210-101-2P-TL00	150	100	50

Measurement equipment

Measurement item	Product No.	Manufacturer
Common mode impedance	4991A	Keysight Technologies
Common mode inductance	4294A	Keysight Technologies
DC resistance	4338A	Keysight Technologies
Insulation resistance	4339A	Keysight Technologies

* Equivalent measurement equipment may be used.



⚠ Please be sure to request delivery specifications that provide further details on the features and specifications of the products for proper and safe use. (1/4)
Please note that the contents may change without any prior notice due to reasons such as upgrading.

20221024

cmf_automotive_signal_act1210_en

ACT1210 type

■ IMPEDANCE VS. FREQUENCY CHARACTERISTICS

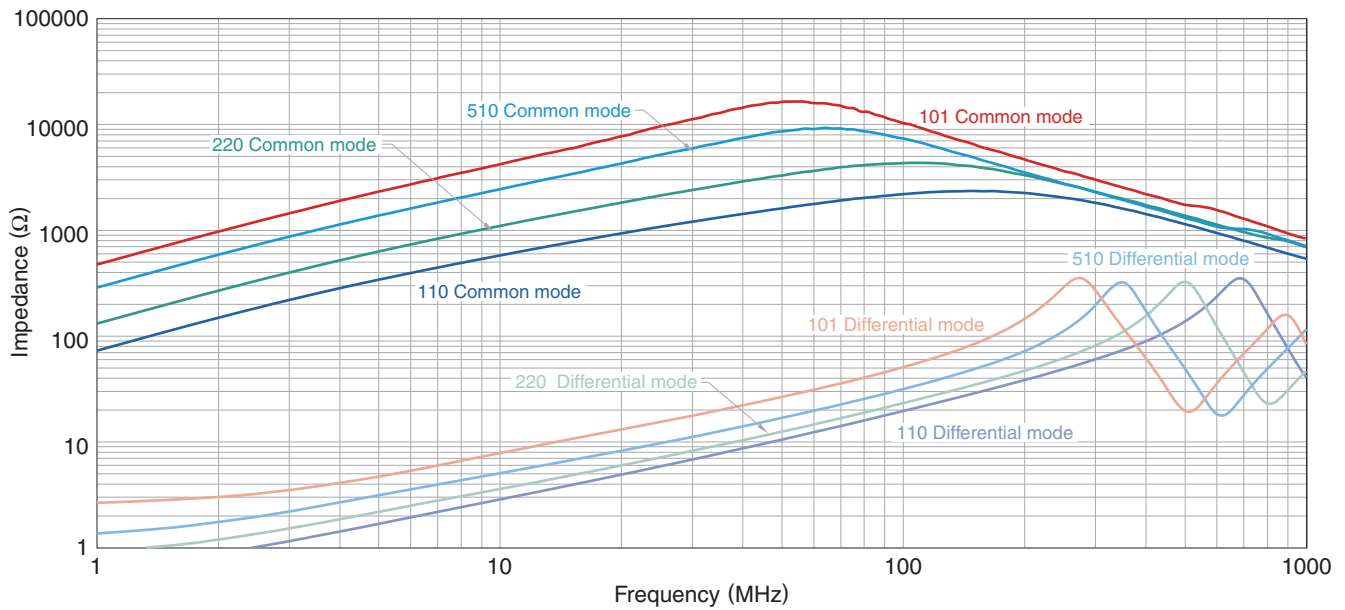

Measurement equipment

Product No.	Manufacturer
4991A	Keysight Technologies

* Equivalent measurement equipment may be used.

ACT1210 type

SHAPE & DIMENSIONS

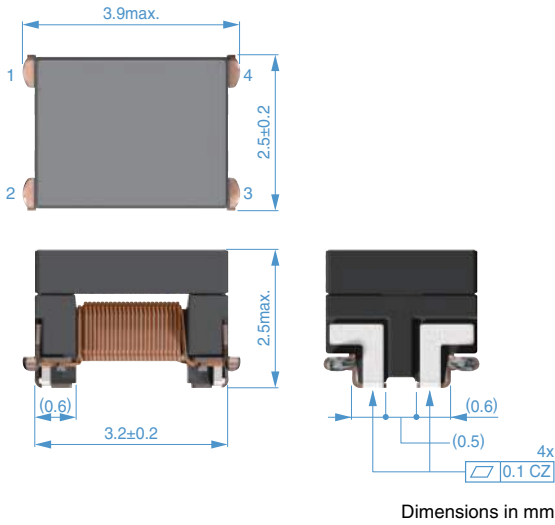

PACKAGING STYLE

REEL DIMENSIONS

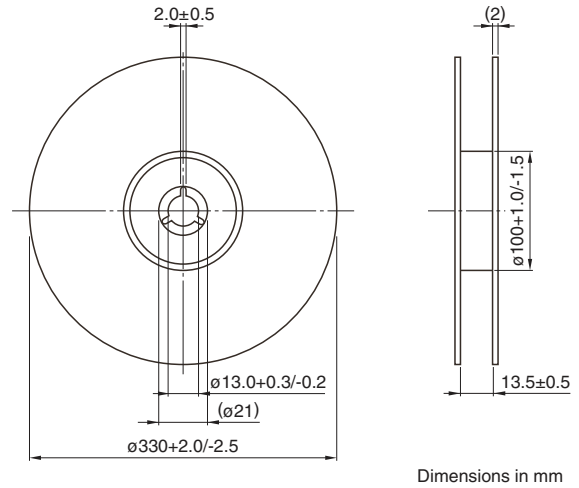

RECOMMENDED LAND PATTERN

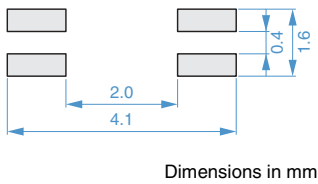

TAPE DIMENSIONS

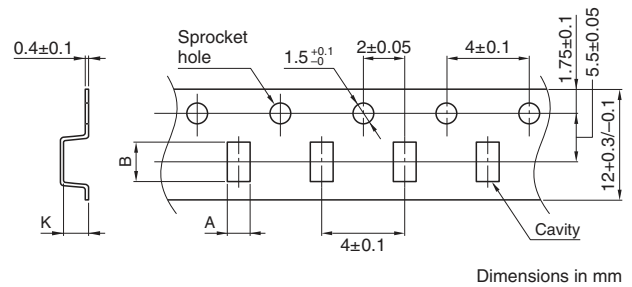

CIRCUIT DIAGRAM

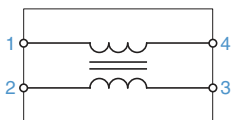

• No polarity

RECOMMENDED REFLOW PROFILE

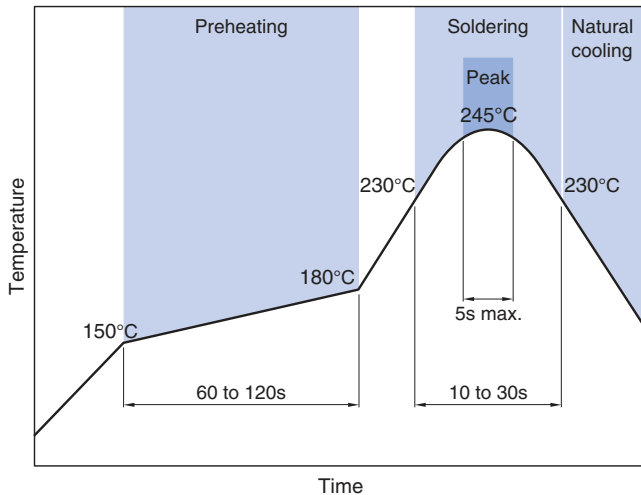

TEMPERATURE RANGE, INDIVIDUAL WEIGHT

Operating temperature range	Individual weight
-55 to +150°C	0.075 g

Type	A	B	K
ACT1210	(2.85)	(4.2)	(2.7)

PACKAGE QUANTITY

Package quantity	6,000 pcs/reel
------------------	----------------

REMINDERS FOR USING THESE PRODUCTS

Before using these products, be sure to request the delivery specifications.

SAFETY REMINDERS

Please pay sufficient attention to the warnings for safe designing when using this products.

REMINDERS

- The storage period is within 12 months. Be sure to follow the storage conditions (temperature: 5 to 40°C, humidity: 10 to 75% RH or less).
If the storage period elapses, the soldering of the terminal electrodes may deteriorate.
- Do not use or store in locations where there are conditions such as gas corrosion (salt, acid, alkali, etc.).
- Soldering corrections after mounting should be within the range of the conditions determined in the specifications.
If overheated, a short circuit, performance deterioration, or lifespan shortening may occur.
- When embedding a printed circuit board where a chip is mounted to a set, be sure that residual stress is not given to the chip due to the overall distortion of the printed circuit board and partial distortion such as at screw tightening portions.
- Self heating (temperature increase) occurs when the power is turned ON, so the tolerance should be sufficient for the set thermal design.
- Carefully lay out the coil for the circuit board design of the non-magnetic shield type.
A malfunction may occur due to magnetic interference.
- Use a wrist band to discharge static electricity in your body through the grounding wire.
- Do not expose the products to magnets or magnetic fields.
- Do not use products that have received any excessive mechanical shock such as by being dropped.
- The performance of the product may deteriorate or at the worst case open if coating materials are used, thus please assess the situation beforehand by taking this factor into consideration.
- Due to the application of mechanical stress after mounting and handling such as contact, disconnection may occur.
- Do not use for a purpose outside of the contents regulated in the delivery specifications.
- The products listed on this specification sheet (the "Products") are intended for incorporation into automobile and/or equipment to be installed in automobile on the grounds that (i) the Products are used in accordance with the conditions and scope stated in this specification sheet and (ii) said automobile and/or equipment involving the Products are used under a normal operation and use condition.
Except for said incorporation into automobile and/or equipment installed in automobile, the Products are not designed or warranted to meet the requirements of the applications listed below, whose performance and/or quality require a more stringent level of safety or reliability, or whose failure, malfunction or trouble could cause serious damage to society, person or property. Please understand that we are not responsible for any damage or liability caused by use of the Products in any of the applications listed below or for any other use exceeding the range or conditions set forth in this specification sheet. If you intend to use the Products beyond the condition and scope of this specification sheet or in any of the applications listed below, please contact with our sales office. We will separately discuss with you applicable specification suitable for your intended use:

- 1) Aerospace/Aviation equipment,
- 2) Transportation equipment (e.g. train, ship),
- 3) Medical equipment which directly endanger human life,
- 4) Power-generation control equipment,
- 5) Atomic energy-related equipment,
- 6) Seabed equipment,
- 7) Transportation control equipment (e.g. train, ship),

- 8) Public information-processing equipment,
- 9) Military equipment,
- 10) Electric heating apparatus / burning equipment,
- 11) Disaster prevention/crime prevention equipment,
- 12) Safety equipment, or
- 13) Other applications that are not considered general-purpose applications.

When designing your equipment involving the Products, you are kindly requested to take into consideration securing protection circuit/equipment or providing backup circuits, etc. in your equipment, to ensure higher safety.

As stated above, the Products are intended for incorporation into automobile and/or equipment to be installed in automobile, however, it is not prohibited to use the Products for general electronic equipment which is not required the same high level or reliability as automobile, or which is unlikely to damage its users' life, body and property or to cause extensive impact on society. Accordingly, all description in this specification sheet is applied if the Products are incorporated into general electronic equipment which is used for normal application under a normal operation and use condition.