

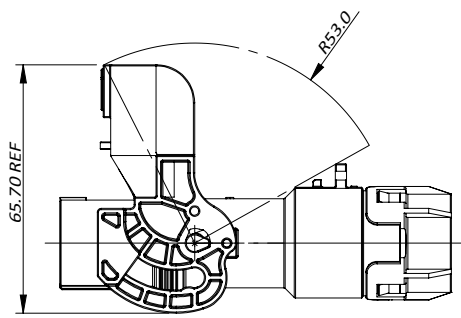

THIS DRAWING IS SUPPLIED FOR INFORMATION ONLY. DESIGN FEATURES, SPECIFICATIONS AND PERFORMANCE DATA SHOWN HEREON ARE THE PROPERTY OF THE AMPHENOL CORPORATION. NO RIGHTS OF REPRODUCTION ARE IMPLIED. ALL DIMENSIONS ARE SUBJECT TO NORMAL MANUFACTURING VARIATIONS.

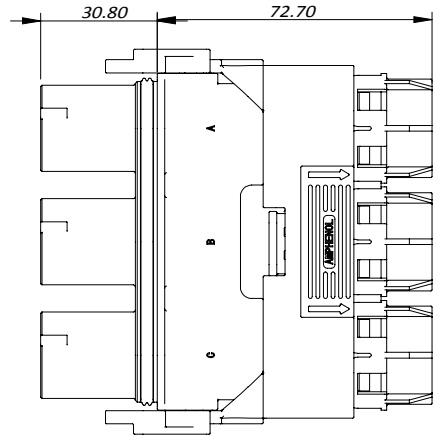

# CUSTOMER DRAWING

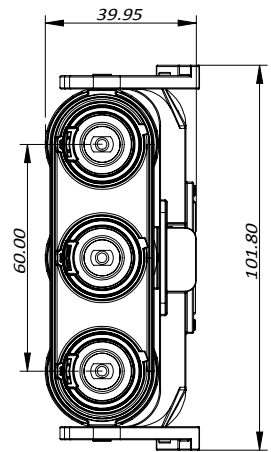
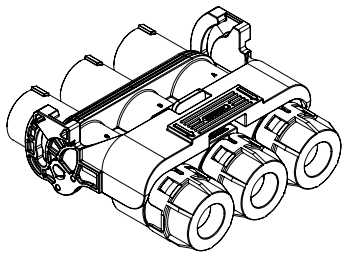

REVISIONS					
REV#	ECN#	REVISION ACTION	REV.BY:	APPR.BY:	DATE
01	--	INITIAL RELEASE	JS	JL	12/28/2018
02	--	增加备注	JS	JL	07/02/2019
03	--	更改结构	Star	James	08/01/2020
04	--	更改描述	Star	James	10/27/2020

- 规格参数(Spec.):
- 工作温度 Operating temperature : -40°C ~ +125°C.
  - 带高压互锁 Electrical interlock (HVIL).
  - 额定电流 Current rating:  
HVIL: 5A.
  - 额定电压 Operating voltage:  
Power: 1000 VDC; Signal: 60 VDC.
  - 耐压 Dielectric withstanding voltage:
    - A. 与插座对插后, Pin与铁壳之间  
When mated, between pin and metal shell: 5000 VDC.
    - B. 与插座对插后, Pin与HVIL之间  
When mated, between pin and HVIL: 5000 VDC.
    - C. 与插座对插后, HVIL与铁壳之间  
When mated, between HVIL and metal shell: 500 VDC.
    - D. 与插座对插前, 两个HVIL端子之间耐压  
Before mating, between two HVIL terminals: 500 VDC.
  - 防护等级 Protection class: Mated-IP6k9k & IP67, unmated-IP2X.
  - 电磁屏蔽 360°full Shielding.
  - 机械寿命 Mating cycle: 100 Min.
  - 带CPA的摇杆系统 Latch system with CPA.
  - 绝缘材料满足UL94 V-0 Inner insulation material satisfy UL94V-0.
  - 镀灰锌/镍合金, 符合RoHS, 满足500H中性盐雾实验  
Gray Zinc/Nickel(ZnNi)Plating, RoHS compliant, Rated at 500hours salt spray.

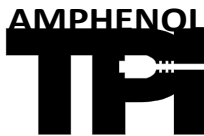
ATPI P/N	Description 	Mating Part
EX-HA004047	PL183Y-30X-BP-2	PL083X-30X-10()-2
EX-HA004048	PL183Y-30X-BP-2	PL083Y-30X-10()-2

	<b>Amphenol Technical Products International Asia.</b>					<b>PART NAME:</b> See Table 1
	第三角投影 THIRD ANGLE PROJECTION 	页面 SHEET 1 OF 1	幅面 SIZE A4	版次 REV. 04	比例 SCALE	
签名 SIGNATURE Star	日期 DATE 10/27/2020	UNLESS OTHERWISE SPECIFIED 1) All dimensions are in metric(mm). 2) Tolerances are as follows: 1.PL DEC ± 1.00 2.PL DEC ± 0.50 3.PL DEC ± 0.20			<b>CUST REV.</b>	
制图 DRAWN	审核 CHECKED	批准 APPROVAL	Angles ±1°			