



SOCKETS AND ACCESSORIES

6,3 (1/4")
SQUARE DRIVE
>160



10 (3/8")
SQUARE DRIVE
>176



12,5 (1/2")
SQUARE DRIVE
>192



20 (3/4")
SQUARE DRIVE
>219



25 (1")
SQUARE DRIVE
>226



FRICTION TYPE RATCHETS
>230



IMPACT TOOLS
>233



BIT RANGE
>251



POWERFUL RATCHETS AND STURDY SOCKETS

Powerful, reliable, durable

A huge variety of types

- › Intelligently designed **ratchets** meet every demand placed and more besides.
- › Sturdy, fine-toothed, durable and extremely resilient
- › Top-grade industrial quality for the hardest of continuous uses
- › Unrivalled diversity of hot-forged **sockets**, metric, inch, TORX®, multi-tooth, internal hexagon or slot and cruciform
- › Screw head protecting profiles (UD bi-hexagonal and hexagonal)

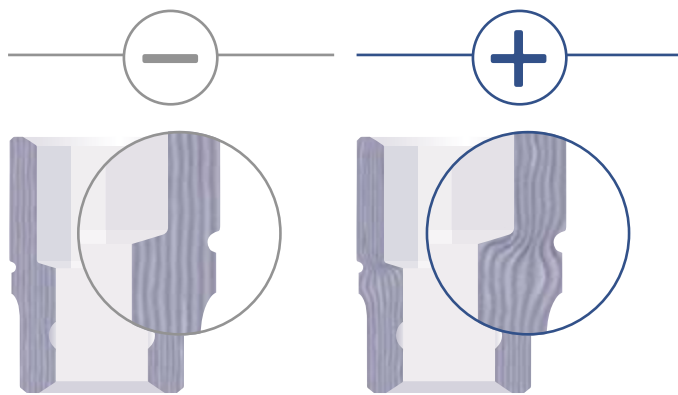

cold forged
Fibers are bent and thus not as stable

hot forged
Fibers are not interrupted

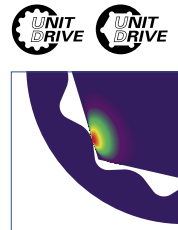
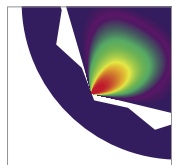

Quality from A - Z...

- › Use of the best-possible raw materials, most up-to-date machinery and environmentally-friendly production processes
- › Our tool specialists vouch for exactness in processing and continuous refinements
- › Unique manufacturing processes and special tool treatment bring about the best in results
- › Stringent quality checks after each production step ensure a constantly high level

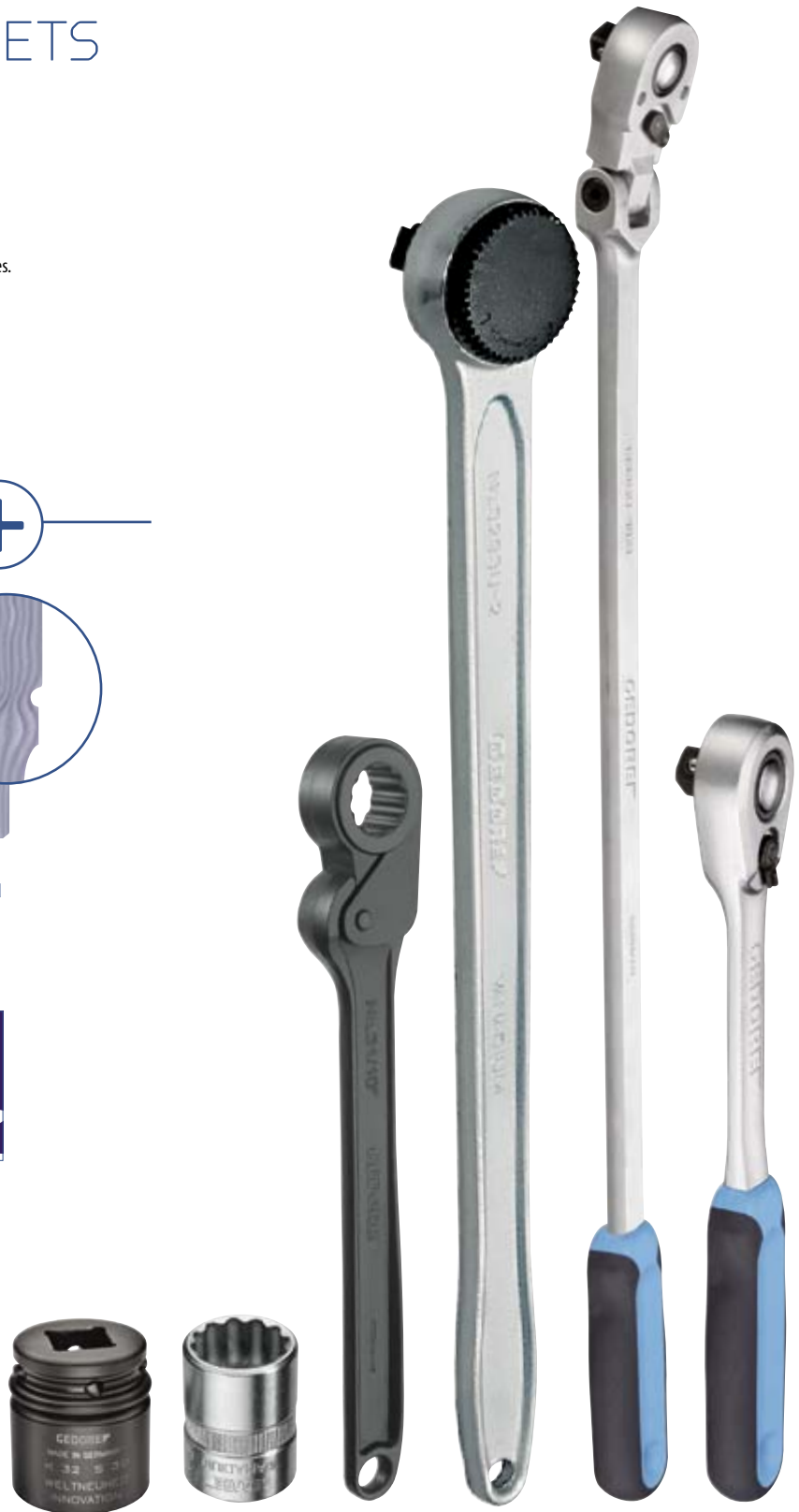



Maximum quality socket sets

- > Innovative, functional design
- > Are blue-hammer finished and from GEDORE
- > Maximum resilience of the sockets and robustness of the drive parts have turned "GEDORE sockets sets" into a household name internationally
- > A name known on the tool market for many years now
- > The sturdy and secure way to keep and carry your tools



From precision mechanics to heavy industry

- > GEDORE operating tools and accessories for professional tool use in each and every industry
- > For heavy continuous use and safety in everyday work
- > Available individually or in practical set compilations, in the module or in sets
- > Customised manufacturing on request



U-20 RATCHETS

DESIGN-ORIENTED PREMIUM RATCHETS

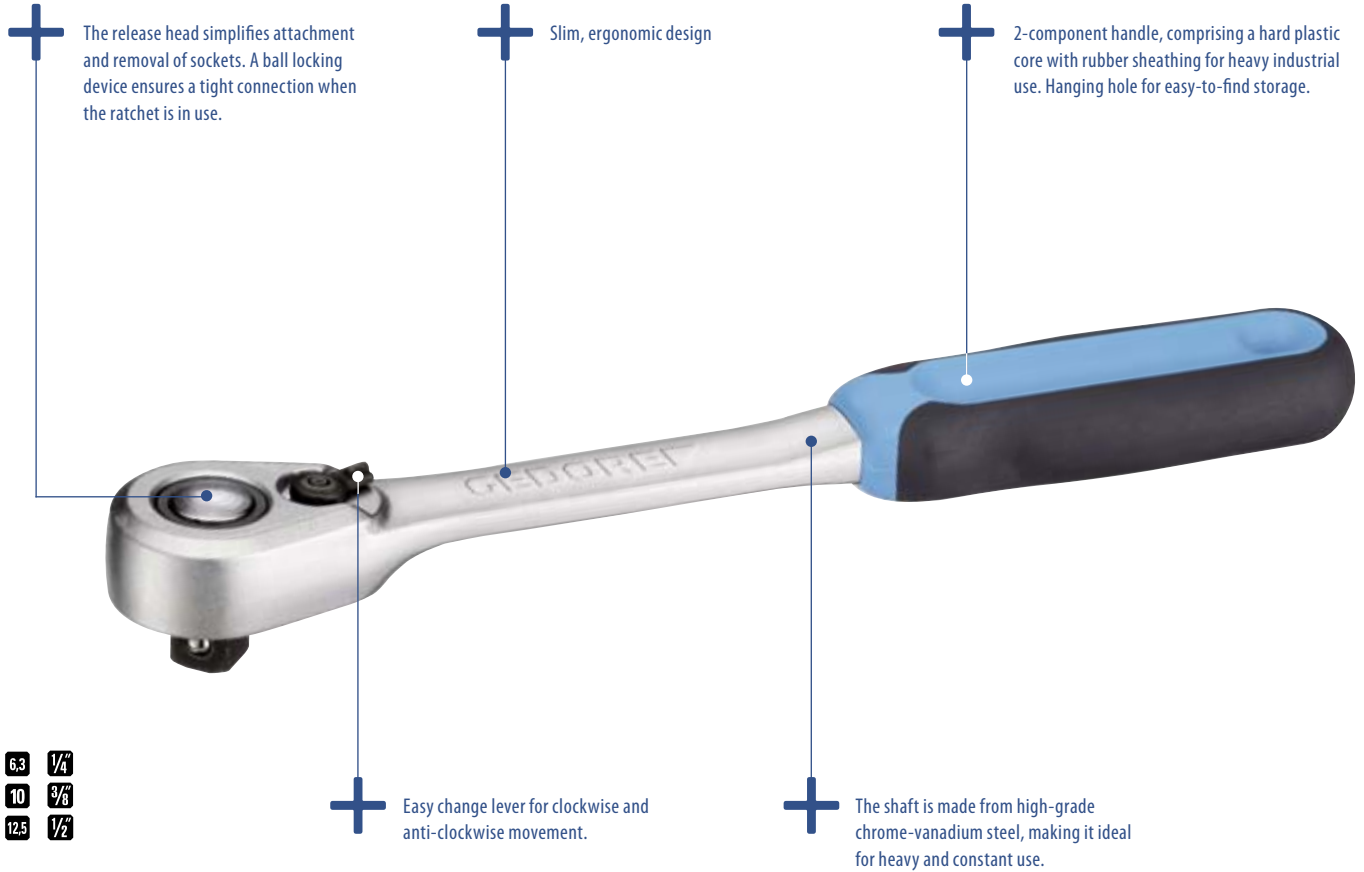

MANUFACTURING PROCESS

Front



Rear



Type of ratchet/Drive

6.3 1/4"

10 3/8"





















































12.5 1/2"

20 3/4"









25 1"

Reversible ratchets

Reversible ratchets (X)XL

	Reversible ratchet for short sockets			1993 U-20 SK 				
	Reversible ratchet with push-button release and lever change	2093 U-20 	3093 U-20 	1993 U-20 				
	Reversible ratchet offset with push-button release and lever change			1993 U-20 G 				
	Reversible ratchet with control lever with centre locking	2093 U-10 	3093 U-10 			3293 U-10 	2193 U-10 	Reversible ratchet with control lever 
	Reversible ratchet with push-button release and lever change with centre locking			1993 U-10 T 				
	Reversible ratchet with push-button release and lever change with centre locking			1993 U-10 L 				
	Aluminium reversible ratchet with push-button release and lever change with centre locking		3093 ALU-10 	1993 ALU-10 				
	Reversible ratchet with metal disc change	2093 U-3 	3093 U-3 	1993 U-3 		3293 U-3 	2193 U-3 	Reversible ratchet with metal disc change 
						3293 U-2 		Reversible ratchet with metal disc change 
	Swivel-head reversible ratchet with metal disc change		3093 GU-3 	1993 GU-3 				
	Swivel-head reversible ratchet with lever change and push-button release			1993 GU-10XL 				
	Ratchet handle with square coupler	2093 Z-94 	3093 Z-94 	1993 Z-94 		3293 Z-94 	2193 Z-94 	

Exclusive GEDORE ratchets

	Friction-type ratchet			31 KR, 31 KVR 29, 31 K 41V-418V				
	Hand ratchet	2093 HR-94 						
	T-handle ratchet	2093 U-3T 	3093 U-3T 					
	Plastic ratchet			1993 U-10K 				



MANUFACTURING PROCESS FOR SOCKETS



1
Blank cropped to size from 31CrV3



2
Hot forged in the forging press.



3
Accurately cropped to size.



4
Outside diameter turned and knurled. For this step and the next, GEDORE uses high-tech machinery from its in-house mechanical engineering department.



5
Counterbored, square socket drive is fluted (ball-stop flute), manufacturer and socket size are permanently stamped.



6
Degreased, since grease would destroy the protective gas atmosphere in hardening.



7
Hardened under protective gas atmosphere, followed by annealing.



8
Sand blasted in preparation for surface coating.



9
Nickel-plated and matt-chrome-plated to prevent dazzle. The electrolytically applied nickel coating ensures corrosion protection. The electroplated chrome improves the look and gives the socket a perfect finish.

Pro GEDORE

- > Use of high alloy 31CrV3 steel
- > Heat formed sockets which have a wear resistant, fine-grained structure and have a long service life
- > Narrow production tolerances ensure an ideal load transmission and low wear and guarantee a long service life
- > Distinctive ball catch ensure secure fit on the square drive

- > Good grip due to deep knurling even when held with oily hands or when working with protective gloves
- > Good look due to chrome plating and varnishing
- > Broad range in all sizes, drive and drive-side and for a wide range of screw types. One of the most diverse ranges in the market.

(*) Not applicable to 1/4" hexagonal sockets

Like all hot-forged tools, GEDORE sockets (*) are characterised by their homogeneous structure. The fibres run in parallel with the contour of the tool. The uninterrupted fibre orientation prevents residual stresses in the structure. In cold-forged tools, the fibres or lines of stress may deviate. Fibre orientation is equally important in nature.

For example, in a tree, the soft fibre orientation is parallel to the branch, so the wood is resistant to bending and twisting. If fibres become kinked, the branch loses its stability at the kink point and breaks. The low-stress GEDORE sockets withstand suddenly occurring peak forces better than cold formed sockets.

(*) Not applicable to 1/4" hexagonal sockets

UNIT-DRIVE PROFIL

>154

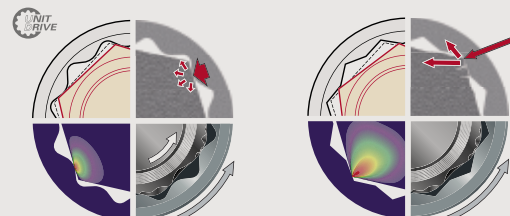

		Unit Drive hexagon	Unit Drive bi-hexagon	Unit Drive bi-hexagon	Unit Drive hexagon	Unit Drive bi-hexagon	External hexagon	External hexagon	Hexagon internal	Internal-TORX®	Internal TORX® with pilot	External TORX®	Internal serrations XZN	Slotted	Cross-slotted PH	Cruciform PZ	Internal TORX® with ball end	Internal hexagon with ball end	Hexagon internal		
		mm	mm	AF	AF	mm	mm	AF	mm											mm	
6,3	L	○	● 4-14	● 3/16-9/16	○	○	● 4-14	● 3/16-9/16	● 2-8	● T8-T40	○	● E4-E10	○	● 4-8	● 1-4	● 1-4	● T10-T40	● K4-K6	○		
	K	○	○	● 3/16-1/2	○	○	● 4-13	● 3/16-1/2	○	● 3-8	○	○	○	○	○	○	○	○	○		
10	L	● 6-24	● 6-24	● 1/4-1	● 1/4-7/8	○	○	○	● 4-10	● T20-T50	● T20-T40	● E4-E10	● 5-10	● 5,5-12	● 1-3	● 1-3	○	○	○	● 1/5-3/8	
	K	○	○	● 10-21	● 3/8-7/8	○	○	○	● 4-10	● T20-T50	○	○	● 5-14	○	○	○	○	○	○	● K4-K10	
12,5	L	● 8-36	● 8-36	● 5/16-11/4	○	● 3/16-3/4W	○	○	● 4-19	● T20-T50	● T20-T50	● E10-E24	● 5-14	● 6,5-18	● 2-4	● 2-4	○	○	○	● K6-K14	● 3/16-5/8
	K	● 10-34	● 10-34	● 1/2-15/16	○	○	○	○	● 5-14	● T20-T50	○	○	● 5-14	○	○	○	○	○	○	○	● K6-K14
20	L	● 18-60	● 18-60	● 7/8-2	○	○	○	○	○	○	○	○	○	○	○	○	○	○	○	○	○
	K	○	○	○	○	○	○	○	○	○	○	○	○	○	○	○	○	○	○	○	○
25	L	○	○	○	○	○	○	○	○	○	○	○	○	○	○	○	○	○	○	○	○
	K	○	○	○	○	○	○	○	○	○	○	○	○	○	○	○	○	○	○	○	○
40	L	○	● 36-80	● 17/16-31/8	○	● 7/8-2W	○	○	○	○	○	○	○	○	○	○	○	○	○	○	○
	K	○	○	○	○	○	○	○	○	○	○	○	○	○	○	○	○	○	○	○	○
63	L	○	○	○	○	○	○	○	○	○	○	○	○	○	○	○	○	○	○	○	○
	K	○	○	○	○	○	○	○	○	○	○	○	○	○	○	○	○	○	○	○	○



6.3 (1/4") square drive

6.3 1/4 6.3 1/4

Sets 6.3 (1/4") MM+INCH



6.3 1/4

D 20 DMU-3
SOCKET SET 1/4"

14 pieces

- > With UD profile sockets and accessories made from GEDORE vanadium steel 31CrV3, hand-operated
- > With fine toothed, dial change ratchet
- > In plastic case
- > Dimensions 160 x 95 x 38 mm

6.3
1/4
mm





Ratchet	Sockets	Accessories		Code	No.
 U-3 2093 U-3	 D 20 4 4,5 5 5,5 6 7 8 9 10 11 12 13	2090-4	0.429	1815598	D 20 DMU-3

INS 20 PM
SCREWDRIVER BIT SOCKET SET 1/4"

15 pieces

- > With hand-operated screwdriver bit sockets in GEDORE vanadium special steel
- > In plastic case
- > Dimensions: 160 x 95 x 38 mm

6.3
1/4

Sockets		Code	No.
 IN 20 3 4 5 6 8	0.285	1815601	INS 20 PM
 IS 20 4 5,5 6,5 8			
 IKS 20 1 2 3			
 IKS 20 PZD 1 2 3			

ITX 20 TX-015

SCREWDRIVER BIT SOCKET SET 1/4"

6.3

1/4"

15 pieces

- > With hand-operated screwdriver bit sockets in GEDORE vanadium special steel
- > In plastic case
- > Dimensions: 160 x 95 x 38 mm
- > TORX® = reg. trademark of Acument Intellectual Properties, LLC. USA



Sockets		Code	No.
<ul style="list-style-type: none"> ⊕ ITX 20 T8 T9 T10 T15 T20 T25 T27 T30 T40 ⊙ TX 20 E4 E5 E6 E7 E8 E10 	0.307	1815628	ITX 20TX-015

ITX 20 PM

SCREWDRIVER BIT SOCKET SET 1/4"

6.3

1/4"

9 pieces

- > With hand-operated screwdriver bit sockets in GEDORE vanadium special steel
- > In plastic case
- > Dimensions: 110 x 65 x 31 mm
- > TORX® = reg. trademark of Acument Intellectual Properties, LLC. USA



Sockets		Code	No.
<ul style="list-style-type: none"> ⊕ ITX 20 T8 T9 T10 T15 T20 T25 T27 T30 T40 	0.174	1815636	ITX 20 PM







D 20 EMU-3 SOCKET SET 1/4"

17 pieces

- > With forged, tempered UD profile sockets, hand-operated
- > With accessories made from GEDORE vanadium steel 31CrV3
- > With fine toothed, dial change ratchet
- > In plastic case
- > Dimensions: 200 x 120 x 38 mm

6,3
1/4"
mm



Ratchet	Sockets	Accessories		Code	No.
 2093 U-3	 D 20 4, 5, 5, 5, 6, 7, 8, 9, 10, 11, 13	 2087  2090-4  2095  676 6,3	0.625	1815652	D 20 EMU-3













D 20 KMU-20 SOCKET SET 1/4"

37 pieces

- > With forged, tempered UD profile sockets, hand-operated
- > With accessories made from GEDORE vanadium steel 31CrV3
- > With robust lever-change reversible ratchet with push-button release
- > In plastic case
- > Dimensions: 200 x 120 x 38 mm
- > TORX® = reg. trademark of Acument Intellectual Properties, LLC. USA

6,3
1/4"
6,3
1/4"
mm



Ratchet	Sockets	Accessories		Code	No.
 2093 U-20	 D 20 4, 5, 6, 7, 8, 9, 10, 11, 12, 13  680 4, 5, 5, 6, 5  685 3, 4, 5, 6  685 X 5, 6, 8  687 TX T10, T15, T20, T25, T27, T30, T40  690 1, 2  690 PZD 1, 2, 3	 2090-4  620  676 699	0.712	1822373	D 20 KMU-20

D 20 KAU-20 SOCKET SET 1/4"

37 pieces

- > With forged, tempered UD profile sockets, hand-operated
- > With accessories made from GEDORE vanadium steel 31CrV3
- > With robust lever-change reversible ratchet with push-button release
- > In plastic case
- > Dimensions: 200 x 120 x 38 mm
- > TORX® = reg. trademark of Acument Intellectual Properties, LLC. USA



Ratchet	Sockets	Accessories	kg	Code	No.
U-20 2093 U-20	D 20 3/16 7/32 1/4 9/32 5/16 11/32 3/8 13/32 7/16 1/2" 680 4 5,5 6,5 685 1/8 5/32 3/16 1/4" 685 X 5 6 8 687 TX T10 T15 T20 T25 T27 T30 T40 690 1 2 690 PZD 1 2 3	2090-4 620 676 699	0.656	2010348	D 20 KAU-20

D 20 TMU-10 SOCKET SET 1/4"

40 pieces

- > With forged, tempered UD profile sockets, hand-operated
- > With accessories made from GEDORE vanadium steel 31CrV3
- > With robust lever change reversible ratchet
- > In plastic case
- > Dimensions: 200 x 120 x 38 mm
- > TORX® = reg. trademark of Acument Intellectual Properties, LLC. USA



Ratchet	Sockets	Accessories	kg	Code	No.
U-10 2093 U-10	D 20 4 5 6 7 8 9 10 11 12 13 680 4 6,5 685 3 4 5 6 8 685 X 5 6 8 687 TX T10 T15 T20 T25 T27 T30 T40 690 1 2 690 PZD 1 2 3	620 639 673 6,3 676 699 2095 2090-4	0.767	1815660	D 20 TMU-10

20 XLU-3 T SOCKET SET 1/4"

37 pieces

- > With forged, tempered hexagon sockets, hand-operated, made from GEDORE vanadium steel 31CrV3
- > Screwdriver bits made from GEDORE vanadium special steel
- > With T-handle ratchet and telescopic extension no. 2099, adjustable from 186-296 mm
- > In plastic case
- > Dimensions: 200 x 120 x 38 mm
- > With "Check-Tool-System": 2-colour foam insert to check that the set is complete
- > TORX® = reg. trademark of Acument Intellectual Properties, LLC. USA

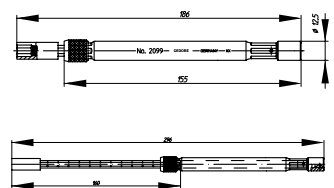

Ratchet	Sockets	Accessories	Weight	Code	No.
2093 U-3 T	<ul style="list-style-type: none"> ○ 20 4 5 6 7 8 9 10 11 12 13 ⊖ 680 4 6,5 ● 685 3 4 5 6 ● 685 X 5 6 8 ⊕ 687 TX T8 T9 T10 T15 T20 T25 T27 T30 T40 ⊕ 690 1 2 ⊕ 690 PZD 1 2 3 	<ul style="list-style-type: none"> 673 6,3 2099 2095 	0.800	1888447	20 XLU-3 T

D 20 MOT BASIC TOOL SET 1/4" FOR MOTORBIKES

30 pieces

- > Packed with a basic assortment of tools for emergencies on motorbikes
- > In plastic case
- > Dimensions: 160 x 95 x 38 mm



Ratchet	Sockets	Accessories	Weight	Code	No.
<ul style="list-style-type: none"> ● U-3 2093 U-3 T 	<ul style="list-style-type: none"> ● D 20 8 9 10 11 12 13 14 ● 685 3 4 5 6 8 10 ⊕ 687 TX T10 T15 T20 T25 T27 T30 T40 ⊕ 690 1 2 3 ⊖ 680 4 6,5 	<ul style="list-style-type: none"> 2090 KR-4 2090-6 2095 620 	0.572	2190281	D 20 MOT











D 20 MOT-A

BASIC TOOL SET 1/4" FOR MOTORBIKES

30 pieces

- > Packed with a basic assortment of tools for emergencies on motorbikes
- > In plastic case
- > Dimensions: 160 x 95 x 38 mm



Ratchet	Sockets	Accessories		Code	No.
 U-3 2093 U-3 T	 D 20 1/4 5/16 3/8 13/32 7/16 1/2 9/16"  685 1/8 5/32 3/16 1/4 5/16 3/8"  687 TX T10 T15 T20 T25 T27 T30 T40  690 1 2 3  680 4 6,5	 2090 KR-4  2090-6  2095  620	0.572	2193159	D 20 MOT-A















20 LMU-10

SOCKET SET 1/4"

49 pieces

- > With forged, tempered long hexagon and short UD profile sockets, hand-operated
- > Accessories in GEDORE vanadium steel 31CrV3
- > With robust lever change reversible ratchet
- > In plastic case
- > Dimensions: 275 x 150 x 42 mm
- > With GEDORE Check-Tool-System: 2-colour foam insert to check that the set is complete
- > TORX® = reg. trademark of Acument Intellectual Properties, LLC. USA



Ratchet	Sockets	Accessories		Code	No.
 U-10 2093 U-10	 D 20 4 5 6 7 8 9 10 11 12 13  20 L 4 4,5 5 6 7 8 9 10 12 13  680 4 6,5  685 3 4 5 6 8  685 X 5 6 8  687 TXT T10 T15 T20 T25 T27 T30 T40  690 1 2  690 PZD 1 2 3	 620  676 699  2090-2 -6  2095	1.262	1815687	20 LMU-10

20 EM

SOCKET SET 1/4"

16 pieces

- > With forged, tempered hexagon sockets, hand-operated
- > With accessories made from GEDORE vanadium steel 31CrV3
- > Set U-10 with reversible lever change ratchet
- > Set U-3 with fine toothed, dial change ratchet
- > Set Z-94 with ratchet with square coupler
- > In plastic case
- > Dimensions: 200 x 120 x 38 mm

6,3
1/4"
mm



Ratchet	Sockets	Accessories	kg	Code	No.
Z-94 2093 Z-94	20 4 4,5 5 5,5 6 7 8 9 10 11 13	2087 2090-4 2095 2098	0.761	6172100	20 EMZ
U-3 2093 U-3	20 4 4,5 5 5,5 6 7 8 9 10 11 13	2087 2090-4 2095 2098	0.776	6172290	20 EMU-3
U-10 2093 U-10	20 4 4,5 5 5,5 6 7 8 9 10 11 13	2087 2090-4 2095 2098	0.790	6162220	20 EMU-10

20 EAU-3

SOCKET SET 1/4"

14 pieces

- > With forged, tempered hexagon sockets, hand-operated
- > With accessories made from GEDORE vanadium steel 31CrV3
- > With extra fine toothed, dial change ratchet
- > In plastic case
- > Dimensions: 200 x 120 x 38 mm

6,3
1/4"
"AF



Ratchet	Sockets	Accessories	kg	Code	No.
U-3 2093 U-3	20 3/16 7/32 1/4 9/32 5/16 11/32 3/8 7/16 1/2"	2087 2090-4 2095 2098	0.767	6172450	20 EAU-3

20 IMU-3 SOCKET SET 1/4"

32 pieces











- > With forged, tempered hexagon sockets, hand-operated
- > With accessories made from GEDORE vanadium steel 31CrV3
- > With fine toothed, dial change ratchet
- > In plastic case
- > Dimensions: 275 x 150 x 42 mm



6.3

1/4"

mm

Ratchet	Sockets	Accessories		Code	No.
 2093 U-3	 20 4 5 6 7 8 9 10 11 12 13 14  IS 20 4 5,5 6,5 8  IN 20 3 4 5 6 8  IKS 20 1 2 3  IKS 20 PZD 1 2 3	 2087  2090-2 -6  2095  2098	1.298	6174150	20 IMU-3

20 ITU-3 SOCKET SET 1/4"

36 pieces











- > With forged, tempered hexagon sockets, hand-operated
- > With accessories made from GEDORE vanadium steel 31CrV3
- > With fine toothed, dial change ratchet
- > In plastic case
- > Dimensions: 275 x 150 x 42 mm
- > TORX® = reg. trademark of Acument Intellectual Properties, LLC. USA



6.3

1/4"

mm

Ratchet	Sockets	Accessories		Code	No.
 2093 U-3	 20 4 5 6 7 8 9 10 11 12 13 14  IN 20 3 4 5 6 8  TX 20 E4 E5 E6 E7 E8 E10  ITX 20 T8 T9 T10 T15 T20 T25 T27 T30	 2087  2090-2 -6  2095  2098	1.376	6196710	20 ITU-3

Ratchets 6.3 (1/4")

2093 U-20 REVERSIBLE RATCHET 1/4"

6.3
1/4"

- > Used throughout industry and the automotive world - and as well in confined spaces
- > Acc. to DIN 3122, ISO 3315
- > Small, drop shaped head for confined areas
- > Fine-toothed, with lever change and push-button release
- > Return angle 9 degrees
- > Non-slip 2-component handle with hanging hole
- > For hand-operated sockets and accessories with square drive as per DIN 3120 - C 6.3, ISO 1174, ball locking device
- > GEDORE vanadium steel 31CrV3, chrome-plated

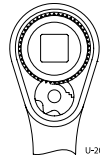

"	mm	°	mm	mm	kg	Code	No.
1/4	6.3	9	127	20	0.095	1703749	2093 U-20

2093 U-10 REVERSIBLE RATCHET 1/4"

6.3
1/4"

- > Particularly for the demanding use experienced in industry and with utility vehicles
- > Acc. to DIN 3122, ISO 3315
- > With recessed lever change, locks in middle position
- > Return angle 15 degrees
- > Non-slip 2-component handle with hanging hole
- > For hand-operated sockets and accessories with square drive as per DIN 3120 - C 6.3, ISO 1174, ball locking device
- > GEDORE vanadium steel 31CrV3, chrome-plated



"	mm	°	mm	mm	kg	Code	No.
1/4	6.3	15	129	21.5	0.109	6180470	2093 U-10

2093 U-3 REVERSIBLE RATCHET 1/4"

- > Especially for working in confined spaces, as in the automotive business
- > Acc. to DIN 3122, ISO 3315
- > With non-slip metal disc change, fine-toothed (72 teeth) and robust
- > Return angle 5 degrees
- > Non-slip 2-component handle with hanging hole
- > For hand-operated sockets and accessories with square drive as per DIN 3120 - C 6.3, ISO 1174, ball locking device
- > GEDORE vanadium steel 31CrV3, chrome-plated



"	mm	°	mm	mm	kg	Code	No.
1/4	6.3	5	129	25	0.095	6170590	2093 U-3

2093 Z-94 RATCHET HANDLE WITH COUPLER 1/4"

- > Used throughout industry and the automotive world
- > Acc. to DIN 3122, ISO 3315
- > With square coupler, medium-fine toothed, extremely rugged
- > Return angle 18 degrees
- > For hand-operated sockets and accessories with square drive as per DIN 3120 - C 6.3, ISO 1174 ball locking device
- > GEDORE vanadium steel 31CrV3, chrome-plated



"	mm	°	mm	mm	kg	Code	No.
1/4	6.3	18	129	12	0.076	6170750	2093 Z-94

2093 U-3 T RATCHET WITH T-HANDLE 1/4"

- > For progressing fast in confined spaces
- > Two-wing T-handle
- > Return angle 5 degrees
- > Ergonomic design for comfortable working
- > For hand-operated sockets and accessories with square drive as per DIN 3120 - C 6.3, ISO 1174, ball locking device
- > The danger of the tool canting, when carrying out work with extensions, is reduced by the central positioning of the square drive



"	mm	°	mm	kg	Code	No.
1/4	6.3	5	140	0.065	1791532	2093 U-3T

2093 HR-94 HAND RATCHET 1/4"

6.3
1/4"

without handle

- > With square coupler
- > Return angle 18 degrees
- > Facilitates working quickly in confined spaces where other ratchets or tools do not fit
- > Especially suitable for servicing work in conjunction with extension 2090-12
- > Dimensions: Ø 26 x 20 mm



"	mm	°	kg	Code	No.
1/4	6.3	18	0.035	6069870	2093 HR-94

Sockets 6.3 (1/4")

20 (MM) SOCKET 1/4"

hexagon

- > Acc. to DIN 3124, ISO 2725-1
- > Square drive as per DIN 3120 - C 6.3, ISO 1174, with ball retaining groove
- > Hand-operated, knurled grip
- > GEDORE vanadium steel 31CrV3, polished, chrome-plated

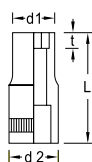

Ø mm	L	d ₁	d ₂	t		Code	No.
4.0	25	6.9	12.0	2.0	0.009	6165400	20 4
4.5	25	7.5	12.0	2.3	0.010	6165590	20 4,5
5.0	25	8.2	12.0	2.5	0.010	6165670	20 5
5.5	25	8.8	12.0	3.0	0.010	6165750	20 5,5
6.0	25	9.4	12.0	3.5	0.010	6165830	20 6
7.0	25	11.0	12.0	4.0	0.011	6165910	20 7
8.0	25	12.0	12.0	5.0	0.014	6166050	20 8
9.0	25	13.0	13.0	5.0	0.016	6166130	20 9
10.0	25	14.7	14.7	6.0	0.018	6166210	20 10
11.0	25	16.0	16.0	7.0	0.025	6166480	20 11
12.0	25	17.0	17.0	8.0	0.029	6166560	20 12
13.0	25	18.5	18.5	8.0	0.030	6166640	20 13
14.0	25	19.7	19.7	10.0	0.037	6166720	20 14

20 (AF) SOCKET 1/4"

hexagon

- > Square drive as per DIN 3120 - C 6.3, ISO 1174, with ball retaining groove
- > Hand-operated, knurled grip
- > GEDORE vanadium steel 31CrV3, polished, chrome-plated

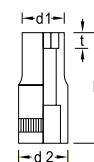

Ø AF	L	d ₁	d ₂	t		Code	No.
3/16	25	7.8	12.0	2.5	0.009	6167020	20 3/16AF
7/32	25	8.8	12.0	3.0	0.009	6167100	20 7/32AF
1/4	25	9.8	12.0	3.5	0.025	6167290	20 1/4AF
9/32	25	11.0	12.0	4.0	0.010	6167370	20 9/32AF
5/16	25	12.0	12.0	5.0	0.013	6167450	20 5/16AF
11/32	25	13.0	13.0	5.0	0.015	6167530	20 11/32AF
3/8	25	14.0	14.0	6.0	0.018	6167610	20 3/8AF
7/16	25	16.0	16.0	7.0	0.023	6167880	20 7/16AF
1/2	25	18.0	18.0	8.0	0.029	6167960	20 1/2AF
9/16	25	20.0	20.0	10.0	0.036	6161840	20 9/16AF

20 L (MM) SOCKET 1/4"

hexagon, long pattern

- > Acc. to DIN 3124, ISO 2725-1
- > Square drive as per DIN 3120 - C 6.3, ISO 1174, with ball retaining groove
- > Hand-operated, knurled grip
- > GEDORE vanadium steel 31CrV3, polished, chrome-plated

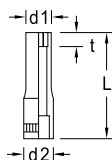

Ø mm	L	d ₁	d ₂	t		Code	No.
4.0	50	6.9	12.0	3.0	0.017	6191400	20 L 4
4.5	50	7.5	12.0	3.4	0.017	6191590	20 L 4,5
5.0	50	8.2	12.0	3.7	0.018	6191670	20 L 5
5.5	50	8.8	12.0	4.5	0.019	6191750	20 L 5,5
6.0	50	9.4	12.0	5.2	0.020	6191830	20 L 6
7.0	50	11.0	12.0	6.0	0.024	6191910	20 L 7
8.0	50	12.0	12.0	7.5	0.027	6192050	20 L 8
9.0	50	13.0	13.0	7.5	0.030	6192130	20 L 9
10.0	50	14.7	14.7	9.0	0.033	6192210	20 L 10
11.0	50	16.0	16.0	10.5	0.047	6192480	20 L 11
12.0	50	17.0	17.0	12.0	0.050	6192560	20 L 12
13.0	50	18.5	18.5	12.0	0.054	6192640	20 L 13

20 L (AF) SOCKET 1/4"

hexagon, long pattern

- > Square drive as per DIN 3120 - C 6.3, ISO 1174, with ball retaining groove
- > Hand-operated, knurled grip
- > GEDORE vanadium steel 31CrV3, polished, chrome-plated

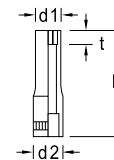

Ø AF	L	d ₁	d ₂	t		Code	No.
3/16	50	7.8	12.0	3.7	0.016	6192800	20 L 3/16AF
7/32	50	8.8	12.0	4.5	0.017	6192990	20 L 7/32AF
1/4	50	9.8	12.0	5.2	0.017	6193020	20 L 1/4AF
9/32	50	11.0	12.0	6.0	0.022	6193100	20 L 9/32AF
5/16	50	12.0	12.0	7.5	0.025	6193290	20 L 5/16AF
11/32	50	13.0	13.0	7.5	0.029	6193370	20 L 11/32AF
3/8	50	14.0	14.0	9.0	0.033	6193450	20 L 3/8AF
7/16	50	16.0	16.0	10.5	0.043	6193530	20 L 7/16AF
1/2	50	18.0	18.0	12.0	0.054	6193610	20 L 1/2AF

D 20 (MM) SOCKET 1/4"

bi-hexagon UD profile

- > Acc. to DIN 3124, ISO 2725-1
- > Square drive as per DIN 3120 - C 6.3, ISO 1174, with ball retaining groove
- > Hand-operated, knurled grip
- > GEDORE vanadium steel 31CrV3, polished, chrome-plated

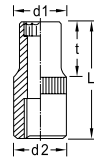
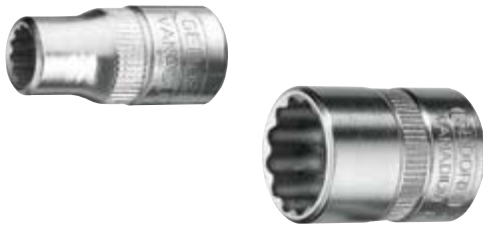

Ø mm	L	d ₁	d ₂	t		Code	No.
4.0	25	6.9	12.0	2.0	0.009	1649558	D 20 4
4.5	25	7.5	12.0	2.3	0.008	1649566	D 20 4,5
5.0	25	8.2	12.0	2.5	0.011	1649574	D 20 5
5.5	25	8.8	12.0	3.0	0.012	1802402	D 20 5,5
6.0	25	9.4	12.0	3.5	0.010	1649582	D 20 6
7.0	25	11.0	12.0	4.0	0.013	1649590	D 20 7
8.0	25	12.0	12.0	5.0	0.013	6225750	D 20 8
9.0	25	13.0	13.0	5.0	0.015	6225830	D 20 9
10.0	25	14.7	14.7	6.0	0.020	6226050	D 20 10
11.0	25	16.0	16.0	7.0	0.024	6226130	D 20 11
12.0	25	17.0	17.0	8.0	0.026	6226480	D 20 12
13.0	25	18.5	18.5	8.0	0.029	6226640	D 20 13
14.0	25	19.7	19.7	10.0	0.036	6226720	D 20 14

D 20 (AF) SOCKET 1/4"

bi-hexagon UD profile

- > Square drive as per DIN 3120 - C 6.3, ISO 1174, with ball retaining groove
- > Hand-operated, knurled grip
- > GEDORE vanadium steel 31CrV3, polished, chrome-plated

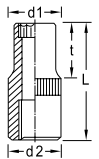

Ø "AF	L	d ₁	d ₂	t		Code	No.
3/16	25	7.8	12.0	2.5	0.010	1812505	D 20 3/16AF
7/32	25	8.8	12.0	3.0	0.011	1812513	D 20 7/32AF
1/4	25	9.8	12.0	3.5	0.011	1812521	D 20 1/4AF
9/32	25	11.0	12.0	4.0	0.012	1812548	D 20 9/32AF
5/16	25	12.0	12.0	5.0	0.012	6226800	D 20 5/16AF
11/32	25	13.0	13.0	5.0	0.015	6226990	D 20 11/32AF
3/8	25	14.0	14.0	6.0	0.017	6227020	D 20 3/8AF
13/32	25	15.0	15.0	6.0	0.020	1901702	D 20 13/32AF
7/16	25	16.0	16.0	7.0	0.022	6227370	D 20 7/16AF
1/2	25	18.0	18.0	8.0	0.028	6227450	D 20 1/2AF
9/16	25	20.0	20.0	10.0	0.034	6228180	D 20 9/16AF

D 20 L SOCKET 1/4"

bi-hexagon UD profile, long pattern

- > Square drive as per DIN 3120 - C 6.3, ISO 1174, with ball retaining groove
- > Hand-operated, knurled grip
- > GEDORE vanadium steel 31CrV3, polished, chrome-plated



Ø "AF	L	d ₁	d ₂	t		Code	No.
3/16	50	7.8	12.0	3.7	0.017	1965433	D 20 L 3/16AF
7/32	50	8.8	12.0	4.5	0.019	1965476	D 20 L 7/32AF
1/4	50	9.8	12.0	5.2	0.017	1965417	D 20 L 1/4AF
9/32	50	11.0	12.0	6.0	0.043	1965484	D 20 L 9/32AF
5/16	50	12.0	12.0	7.5	0.024	1965441	D 20 L 5/16AF
11/32	50	13.0	13.0	7.5	0.043	1965492	D 20 L 11/32AF
3/8	50	14.0	14.0	9.0	0.035	1965425	D 20 L 3/8AF
7/16	50	16.0	16.0	10.5	0.043	1965468	D 20 L 7/16AF
1/2	50	18.0	18.0	12.0	0.054	1965409	D 20 L 1/2AF

TX 20 SOCKET 1/4"

for protruding TORX® head screws

- > Square drive as per DIN 3120 - C 6.3, ISO 1174, with ball retaining groove
- > Hand-operated, knurled grip
- > GEDORE vanadium steel 31CrV3, polished, chrome-plated
- > TORX® = reg. trademark of Acument Intellectual Properties, LLC. USA

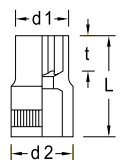

Ø			mm	L	d ₁	d ₂	t		Code	No.
E4	M3	3,86	25	5.5	12	4.5	0.008	6193880	TX 20 E4	
E5	M4	4,73	25	7.0	12	5.0	0.009	6187640	TX 20 E5	
E6	M5	5,74	25	8.0	12	5.0	0.010	6187720	TX 20 E6	
E7	M6	6,16	25	9.5	12	6.0	0.011	6187800	TX 20 E7	
E8	M6 - M7	7,52	25	10.5	12	6.5	0.014	6187990	TX 20 E8	
E10	M8	9,42	25	13.0	13	7.0	0.018	6193960	TX 20 E10	

ITX 20

SCREWDRIVER BIT SOCKET

1/4"

6.3
1/4"

for recessed TORX® head screws

- > Square drive as per DIN 3120 - C 6.3, ISO 1174, with ball retaining groove
- > Hand-operated, knurled grip
- > Chrome-plated
- > With pressed-in pin in GEDORE vanadium special steel, gun-metal finish
- > TORX® = reg. trademark of Acument Intellectual Properties, LLC. USA

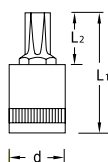

⊕	M	mm	L ₁	L ₂	d	kg	Code	No.
T8	M2,5	2,31	30.5	14.5	12	0.013	6190430	ITX 20 T8
T9	M3	2,50	30.5	14.5	12	0.013	6190510	ITX 20 T9
T10	M3 - M3,5	2,74	30.5	14.5	12	0.014	6190780	ITX 20 T10
T15	M3,5 - M4	3,27	30.5	14.5	12	0.014	6190860	ITX 20 T15
T20	M4 - M5	3,86	30.5	14.5	12	0.014	6190940	ITX 20 T20
T25	M4,5 - M5	4,43	30.5	14.5	12	0.014	6191080	ITX 20 T25
T27	M4,5 - M6	4,99	30.5	14.5	12	0.014	6191160	ITX 20 T27
T30	M6 - M7	5,52	30.5	14.5	12	0.015	6191240	ITX 20 T30
T40	M7 - M8	6,65	33.5	14.0	14	0.025	6265890	ITX 20 T40

ITX 20 K

SCREWDRIVER BIT SOCKET

1/4"

6.3
1/4"

with ball end, for recessed TORX® head screws

- > Square drive as per DIN 3120 - C 6.3, ISO 1174, with ball retaining groove
- > Hand-operated, knurled grip
- > Chrome-plated
- > With pressed-in pin in GEDORE vanadium special steel, gun-metal finish
- > Swivel angle approx. 15-20°
- > Optimum transfer of power, also at places which are difficult of access
- > TORX® = reg. trademark of Acument Intellectual Properties, LLC. USA



ITX 20 K T10

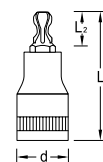

⊕	M	mm	L ₁	L ₂	d	kg	Code	No.
T10	M3 - M3,5	2,74	30.5	14.5	12	0.015	6120220	ITX 20 K T10
T15	M3,5 - M4	3,27	30.5	14.5	12	0.015	6120300	ITX 20 K T15
T20	M4 - M5	3,86	30.5	14.5	12	0.015	6120490	ITX 20 K T20
T25	M4,5 - M5	4,43	30.5	14.5	12	0.015	6120570	ITX 20 K T25
T27	M4,5 - M6	4,99	30.5	14.5	12	0.015	6120650	ITX 20 K T27
T30	M6 - M7	5,52	30.5	14.5	12	0.015	6120730	ITX 20 K T30
T40	M7 - M8	6,65	33.5	14.0	14	0.025	6120810	ITX 20 K T40

IS 20

SCREWDRIVER BIT SOCKET

1/4"

6.3
1/4"

for slotted head screws

- > Square drive as per DIN 3120 - C 6.3, ISO 1174, with ball retaining groove
- > Hand-operated, knurled grip
- > Chrome-plated
- > Bit in GEDORE vanadium special steel, manganese-phosphated
- > Bit as per DIN ISO 2380-1 Form B

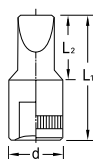

⊖ mm±C	mm±C	L ₁	L ₂	d	kg	Code	No.
4.0	0.8	28	14.5	12	0.011	6171560	IS 20 4x0,8
5.5	1.0	28	14.5	12	0.012	6171640	IS 20 5,5x1
6.5	1.2	28	14.5	12	0.012	6174230	IS 20 6,5x1,2
8.0	1.6	28	14.5	12	0.012	6174310	IS 20 8x1,6

IKS 20

SCREWDRIVER BIT SOCKET

1/4"

6.3
1/4"

for cross-head screws PH

- > Square drive as per DIN 3120 - C 6.3, ISO 1174, with ball retaining groove
- > Hand-operated, knurled grip
- > Chrome-plated
- > Bit in GEDORE vanadium special steel, manganese-phosphated
- > Tip as per DIN ISO 8764-1 PH

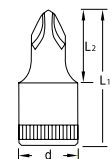

⊕ PH	L ₁	L ₂	d	kg	Code	No.
1	28	14.5	12	0.011	6174580	IKS 20 1
2	28	14.5	12	0.012	6174660	IKS 20 2
3	28	14.5	12	0.012	6174740	IKS 20 3
4	28	14.5	12	0.014	6174820	IKS 20 4

IKS 20 PZ SCREWDRIVER BIT SOCKET 1/4"

6.3
1/4"

for cross-head screws Pozi PZ

- > Square drive as per DIN 3120 - C 6.3, ISO 1174, with ball retaining groove
- > Hand-operated, knurled grip
- > Chrome-plated
- > Bit in GEDORE vanadium special steel, manganese-phosphated
- > Tip as per DIN ISO 8764-1 PZ

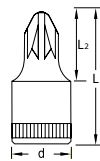

⊕ PZ	L ₁	L ₂	d	⚖	Code	No.
1	28	14.5	12	0.012	6187130	IKS 20 PZD 1
2	28	14.5	12	0.013	6187210	IKS 20 PZD 2
3	28	14.5	12	0.014	6187480	IKS 20 PZD 3
4	28	14.5	12	0.015	6187560	IKS 20 PZD 4

IN 20 SCREWDRIVER BIT SOCKET 1/4"

6.3
1/4"

for in-hex screws

- > Acc. to DIN 7422
- > Square drive as per DIN 3120 - C 6.3, ISO 1174, with ball retaining groove
- > Hand-operated, knurled grip
- > Chrome-plated
- > Bit in GEDORE vanadium special steel, manganese-phosphated
- * not standardised

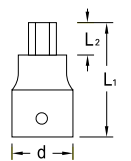

● mm	L ₁	L ₂	d	⚖	Code	No.
2	*	28	3.0	12	0.010	1812556 IN 20 2
2,5	*	28	3.5	12	0.010	1707736 IN 20 2,5
3		28	5.5	12	0.011	6176010 IN 20 3
4		28	7.0	12	0.011	6176280 IN 20 4
5		28	8.0	12	0.012	6176360 IN 20 5
6		28	8.5	12	0.013	6178490 IN 20 6
8	*	28	10.0	12	0.016	6178570 IN 20 8

IN 20 L SCREWDRIVER BIT SOCKET 1/4"

6.3
1/4"

for in-hex screws, long pattern

- > Acc. to DIN 7422
- > Square drive as per DIN 3120 - C 6.3, ISO 1174, with ball retaining groove
- > Hand-operated, knurled grip
- > Chrome-plated
- > Bit in GEDORE vanadium special steel, manganese-phosphated

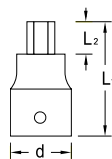

● mm	L ₁	L ₂	d	⚖	Code	No.
3	60	32	12	0.024	1933256	IN 20 L 3-60
4	60	32	12	0.025	1933264	IN 20 L 4-60
5	60	32	12	0.027	1933272	IN 20 L 5-60
6	60	32	12	0.029	1933280	IN 20 L 6-60
8	60	32	14	0.050	1933299	IN 20 L 8-60

IN 20 K SCREWDRIVER BIT SOCKET 1/4"

6.3
1/4"

with ball end, for in-hex screws

- > Square drive as per DIN 3120 - C 6.3, ISO 1174, with ball retaining groove
- > Hand-operated, knurled grip
- > Chrome-plated
- > With pressed-in pin, manganese-phosphated
- > Total swivel angle approx. 15-20°

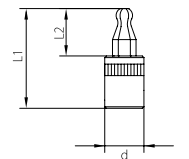

● mm	L ₁	L ₂	d	⚖	Code	No.
4	30.5	14.5	12	0.010	2219409	IN 20 K 4
5	30.5	14.5	12	0.010	2219417	IN 20 K 5
6	30.5	14.5	12	0.013	2219468	IN 20 K 6

Accessories 6.3 (1/4")

2097 SWIVEL HANDLE 1/4"

- > Acc. to DIN 3122, ISO 3315
- > For hand-operated sockets with square drive as per DIN 3120, ISO 1174, with ball locking device
- > GEDORE vanadium steel 31CrV3, polished, chrome-plated, square drive manganese-phosphated



1/4"	6.3	146	0.094	Code	No.
1/4	6.3	146	0.094	6171050	2097

2098 T DRIVING HANDLE 1/4"

- > For hand-operated sockets with square drive as per DIN 3120, ISO 1174, with ball locking device
- > With bit adaptor no. 620 also suitable for 1/4" bits
- > Easy access to deep-fitting screws in confined areas
- > The danger of the tool canting, is reduced by the central positioning of the square drive
- > 2C-T-handle with hanging hole



1/4"	6.3	300	0.150	Code	No.
1/4	6.3	300	0.150	1939998	2098 T

2098 DRIVING HANDLE 1/4"

- > Acc. to DIN 3122, ISO 3315
- > For hand-operated sockets with square drive as per DIN 3120, ISO 1174, with ball locking device



1/4"	6.3	140	0.070	Code	No.
1/4	6.3	140	0.070	6171480	2098

2087 SLIDING T BAR 1/4"

- > Acc. to DIN 3122, ISO 3315
- > For hand-operated sockets with square drive as per DIN 3120, ISO 1174, with ball locking device
- > GEDORE vanadium steel 31CrV3, polished, chrome-plated



1/4"	6.3	115	0.039	Code	No.
1/4	6.3	115	0.039	6170160	2087

2090 EXTENSION 1/4"

- > Acc. to DIN 3123, ISO 3316
- > For hand-operated sockets with square drive as per DIN 3120, ISO 1174, with ball locking device
- > GEDORE vanadium steel 31CrV3, polished, chrome-plated
- * not standardised



2090-2



2090-4



2090-6



2090-12

1/4"	6.3	55	0.025	Code	No.
1/4	6.3	55	0.025	6170320	2090-2
1/4	6.3	97	0.041	6170400	2090-4

1/4"	6.3	148	0.061	Code	No.
1/4	6.3	148	0.061	6171210	2090-6
1/4	6.3	*	0.124	6173340	2090-12

2088 FLEXIBLE EXTENSION 1/4"

- > For hand-operated sockets with square drive as per DIN 3120, ISO 1174, with ball locking device
- > GEDORE vanadium steel 31CrV3, polished, chrome-plated



□"	■	↳ mm ▷	⚖ kg	Code	No.
1/4	6.3	120	0.046	6170240	2088

2090 A EXTENSION 1/4"

with release

- > Easy access to deep-fitting screws in confined areas
- > No unintentional release of the socket from the extension due to safety ring
- > For hand-operated sockets with square drive as per DIN 3120, ISO 1174, ball locking device



□"	■	↳ mm ▷	⚖ kg	Code	No.
1/4	6.3	55	0.030	1932284	2090 A-2
1/4	6.3	97	0.050	1932292	2090 A-4
1/4	6.3	305	0.125	1932306	2090 A-12

2090 KR UNIVERSAL EXTENSION 1/4"

- > With ball end
- > For hand-operated sockets with square drive as per DIN 3120, ISO 1174, with ball locking device
- > The extension is able to pivot up to 15°
- > GEDORE vanadium steel 31CrV3, polished, chrome-plated



□"	■	↳ mm ▷	⚖ kg	Code	No.
1/4	6.3	55	0.024	1812564	2090 KR-2
1/4	6.3	97	0.045	1812572	2090 KR-4
1/4	6.3	148	0.060	6121030	2090 KR-6

2094 COUPLER 1/4"

- > Acc. to DIN 3122, ISO 3315
- > For hand-operated sockets with square drive as per DIN 3120, ISO 1174, with ball locking device
- > GEDORE vanadium steel 31CrV3, polished, chrome-plated



□"	■	↳ mm ▷	⚖ kg	Code	No.
1/4	6.3	19.8	0.006	6170830	2094

2099 TELESCOPIC EXTENSION 1/4"



magnetic

- > With 1/4" female square drive and 1/4" female hexagon drive
- > Automatic, form-fit connection
- > Adjustable in 10 mm steps from 192-296 mm
- > Suitable for 1/4" bits as well as with adaptor no. 673 for sockets up to 13 mm
- > Made of quality steel, manganese-phosphated resp. chrome-plated

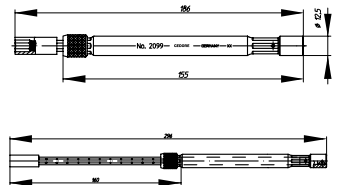

□"	□	○"	○	↳ mm ▷	⚖ kg	Code	No.
1/4	6.3	1/4	6.3	192-296	0.205	1888455	2099

2095 UNIVERSAL JOINT 1/4"

- > Acc. to DIN 3123, ISO 3316
- > For hand-operated sockets with square drive as per DIN 3120, ISO 1174, with ball locking device
- > GEDORE vanadium steel 31CrV3, polished, chrome-plated



□"	■	□"	□	↳ mm ▷	⚖ kg	Code	No.
1/4	6.3	1/4	6.3	38	0.026	6170910	2095

2030 CONVERTOR 1/4" TO 3/8"

- > Acc. to DIN 3123, ISO 3316
- > For hand-operated sockets with square drive as per DIN 3120, ISO 1174, with ball locking device
- > GEDORE vanadium steel 31CrV3, polished, chrome-plated



□"	□	■"	■	↳ mm ▷	⚖ kg	Code	No.
1/4	6.3	3/8	10	26	0.020	6170080	2030

S 2032-05

ADAPTOR SET 1/4" - 3/4"

5 pieces

- > Set of reducers and converters 1/4" - 3/4"
- > Reducers 1930, 3020
- > Convertors 2030, 3019, 1932
- > In transparent plastic box, dimensions: L 134 x W 51 x H 51 mm, foam insert light-blue
- > Please take note of the maximum capacity of the external squares of the reducers acc. to DIN 3123, ISO 3316

- 6.3
- 1/4"
- 10
- 3/8"
- 12.5
- 1/2"
- 20
- 3/4"



Contents		Code	No.
Convertor 2030 1/4" - 3/8"	0.340	1729071	S 2032-05
Convertor 3019 3/8" - 1/2"			
Convertor 1932 1/2" - 3/4"			
Reducer 3020 3/8" - 1/4"			
Reducer 1930 1/2" - 3/8"			

SL 2013

TOOL HOLDING RAIL, MAGNETIC 1/4"

empty

- > External squares to take 13 standard commercial 6.3 mm (1/4") sockets
- > Two female square adaptors to take ratchets, sliding T bars, extensions etc.
- > A strong magnet securely holds the socket rail to ferrous metals
- > Additional holes are provided for wall mounting the socket rail or attaching to non-ferrous materials
- > The sockets are securely locked by the ball at the square-drive end by turning them 90°
- > It is a simple matter to "unlock" and remove the sockets, by turning them 90° in the opposing direction
- > Delivery without tools

- 6.3
- 1/4"
- 6.3
- 1/4"
- 



 mm		Code	No.
380	33	1761080	SL 2013

10 (3/8") square drive

10 3/8 10 3/8

Sets 10 (3/8") METRIC

10 3/8

30 JMU / D 30 JMU SOCKET SET 3/8"

16 pieces

- > With forged, tempered hexagon (no. 30) or bi-hexagon (no. D 30) UD profile sockets, hand-operated
- > With accessories made from GEDORE vanadium steel 31CrV3
- > With reversible lever change ratchet
- > In GEDORE blue sheet steel case
- > Dimensions: 320 x 132 x 55 mm



10
3/8
mm

Ratchet	Sockets	Accessories	kg	Code	No.
U-10 3093 U-10	30 6 7 8 9 10 11 12 13 14 15 16 17 18 19	3090-5	2.2	2682885	30 JMU-10
U-10 3093 U-10	D 30 6 7 8 9 10 11 12 13 14 15 16 17 18 19	3090-5	2.3	2682893	D 30 JMU-10

30 HMU / D 30 HMU SOCKET SET 3/8"

22 pieces

- > With forged, tempered hexagon (no. 30) or bi-hexagon (no. D 30) UD profile sockets, hand-operated
- > With accessories made from GEDORE vanadium steel 31CrV3
- > Set U-3 with fine toothed, dial change ratchet
- > Set U-10 with reversible lever change ratchet
- > In GEDORE blue sheet steel case
- > Dimensions: 320 x 210 x 55 mm



10
3/8
mm

Ratchet	Sockets	Accessories	kg	Code	No.
U-3 3093 U-3	30 6 7 8 9 10 11 12 13 14 15 16 17 18 19 20 21 22	3087 3090-5 -10 3095	3.0	6238300	30 HMU-3
U-10 3093 U-10	30 6 7 8 9 10 11 12 13 14 15 16 17 18 19 20 21 22	3087 3090-5 -10 3095	3.0	6235470	30 HMU-10
U-3 3093 U-3	D 30 6 7 8 9 10 11 12 13 14 15 16 17 18 19 20 21 22	3087 3090-5 -10 3095	3.1	6240470	D 30 HMU-3
U-10 3093 U-10	D 30 6 7 8 9 10 11 12 13 14 15 16 17 18 19 20 21 22	3087 3090-5 -10 3095	3.1	6239700	D 30 HMU-10

30 GMU / D 30 GMU SOCKET SET 3/8"

17 pieces

- > With forged, tempered hexagon (no. 30) or bi-hexagon (no. D 30) UD profile sockets, hand-operated
- > With accessories made from GEDORE vanadium steel 31CrV3
- > Set U-3 with fine toothed, dial change ratchet
- > Set U-10 with reversible lever change ratchet
- > In GEDORE blue sheet steel case
- > Dimensions: 320 x 210 x 55 mm



10
3/8
mm

Ratchet	Sockets	Accessories		Code	No.
U-3 3093 U-3	30 6 7 8 9 10 11 13 14 15 16 17 19	3087 3090-5 -10 3095	2.6	6235980	30 GMU-3
U-10 3093 U-10	30 6 7 8 9 10 11 13 14 15 16 17 19	3087 3090-5 -10 3095	2.6	6235710	30 GMU-10
U-3 3093 U-3	D 30 6 7 8 9 10 11 13 14 15 16 17 19	3087 3090-5 -10 3095	2.7	6240200	D 30 GMU-3
U-10 3093 U-10	D 30 6 7 8 9 10 11 13 14 15 16 17 19	3087 3090-5 -10 3095	2.7	6239380	D 30 GMU-10

30 IMU SOCKET SET 3/8"

26 pieces

- > With forged, tempered hexagon UD profile sockets, hand-operated
- > With accessories made from GEDORE vanadium steel 31CrV3
- > Set U-3 with fine toothed, dial change ratchet
- > Set U-10 with reversible lever change ratchet
- > In GEDORE blue sheet steel case
- > Dimensions: 320 x 210 x 55 mm



10
3/8
mm

Ratchet	Sockets	Accessories		Code	No.
U-3 3093 U-3	30 6 7 8 9 10 11 12 13 14 15 16 17 19 IS 30 5,5 8 IN 30 4 5 6 8 IKS 30 2 3	3087 3090-5 -10 3095	3.1	6229900	30 IMU-3
U-10 3093 U-10	30 6 7 8 9 10 11 12 13 14 15 16 17 19 IS 30 5,5 8 IN 30 4 5 6 8 IKS 30 2 3	3087 3090-5 -10 3095	3.1	6229740	30 IMU-10



D 30 KMU-20 SOCKET SET 3/8"

40 pieces

- > With forged, tempered bi-hexagon UD profile sockets, hand-operated
- > With accessories made from GEDORE vanadium steel 31CrV3
- > With robust lever-change reversible ratchet with push-button release
- > In GEDORE blue sheet steel case
- > Dimensions: 320 x 210 x 55 mm
- > TORX® = reg. trademark of Acument Intellectual Properties, LLC. USA

- 10
- 3/8"
- 6.3
- 1/4"
- mm



Ratchet	Sockets	Accessories		Code	No.
 3093 U-20 3093 U-3 T	 D 30 8 9 10 11 12 13 14 15 16 17 18 19  680 4 5,5 6,5  685 3 4 5 6  685 X 5 6 8  687 TX T10 T15 T20 T25 T27 T30  690 1 2  690 PZD 1 2	 3090 KR-3  3090-5 630 673 10  676 699	2.6	1973347	D 30 KMU-20









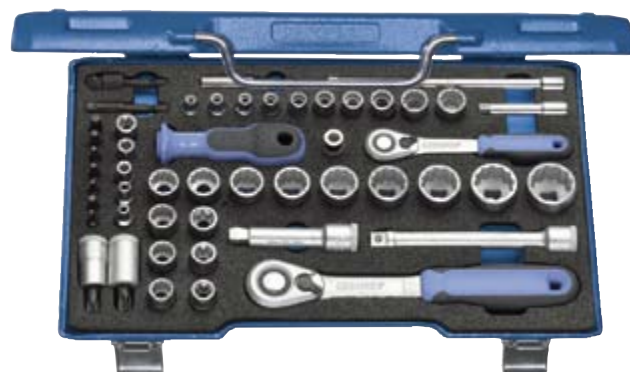





D 30 TX20 U-20 SOCKET SET 3/8" + 1/4"

50 pieces

- > Tool set for general industrial and automotive applications
- > 3/8" and 1/4" sockets for protruding and recessed TORX® screws
- > With robust lever-change reversible ratchets, with push-button release
- > In sheet steel case with Check-Tool insert
- > Dimensions: 320 x 210 x 55 mm
- > TORX® = reg. trademark of Acument Intellectual Properties, LLC. USA

- 10
- 3/8"
- 6.3
- 1/4"
- 6.3
- 1/4"
- mm



Ratchet	Sockets	Accessories		Code	No.
 3093 U-20  2093 U-20	 D 30 10 11 12 13 14 15 16 17 18 19 21 22  TX 30 E11 E12 E14  ITX 30 T45 T50  D 20 4 5 5,5 6 7 8 9 10 12 13  TX 20 E5 E6 E7 E8 E10  687 TX T10 T15 T20 T25 T27 T30 T40	 3090 KR-3  3090-5  2090 KR-2  2090-6 620 673 6,3 10  676 699	3.2	2075695	D 30 TX20 U-20

IN 30 LKM SCREWDRIVER BIT SOCKET SET 3/8"

10
3/8
mm

10 pieces

- > For in-hex screws, short and long
- > In plastic case
- > Dimensions: 200 x 120 x 38 mm



Sockets	kg	Code	No.
● IN 30 4 5 6 8 10	0.761	1509918	IN 30 LKM
● IN 30 L 4 5 6 8 10			

ITX 30 PM SCREWDRIVER BIT SOCKET SET 3/8"

10
3/8

7 pieces

- > For recessed TORX® screws
- > In plastic case
- > Dimensions: 200 x 120 x 38 mm
- > TORX® = reg. trademark of Acument Intellectual Properties, LLC. USA



Sockets	kg	Code	No.
● ITX 30 T20 T25 T27 T30 T40 T45 T50	0.627	1509926	ITX 30 PM

ITX 30 LKP SCREWDRIVER BIT SOCKET SET 3/8"

10
3/8

14 pieces

- > For recessed TORX® screws, short and long
- > In plastic case
- > Dimensions: 200 x 120 x 38 mm
- > TORX® = reg. trademark of Acument Intellectual Properties, LLC. USA



Sockets	kg	Code	No.
● ITX 30 T20 T25 T27 T30 T40 T45 T50	1.081	1509950	ITX 30 LKP
● ITX 30 L T20 T25 T27 T30 T40 T45 T50			

ITX 30 TX-015 SCREWDRIVER BIT SOCKET SET 3/8"

10
3/8

15 pieces

- > For protruding and recessed TORX® screws
- > In plastic case
- > Dimensions: 200 x 120 x 38 mm
- > TORX® = reg. trademark of Acument Intellectual Properties, LLC. USA



Sockets	kg	Code	No.
● ITX 30 T20 T25 T27 T30 T40 T45 T50	0.801	1509942	ITX 30 TX-015
● TX 30 E5 E6 E7 E8 E10 E11 E12 E14			

TX 30 E-08 SOCKET SET 3/8"

10
3/8

8 pieces

- > For protruding TORX® screws
- > In plastic case
- > Dimensions: 160 x 95 x 38 mm
- > TORX® = reg. trademark of Acument Intellectual Properties, LLC. USA



Sockets	kg	Code	No.
● TX 30 E5 E6 E7 E8 E10 E11 E12 E14	0.485	1509934	TX 30 E-08

30 TX 20 SCREWDRIVER BIT SOCKET SET 3/8" + 1/4"

6.3
1/4
10
3/8

28 pieces

- > 3/8" and 1/4" sockets for protruding and recessed TORX® screws
- > In plastic case
- > Dimensions: 275 x 150 x 42 mm
- > TORX® = reg. trademark of Acument Intellectual Properties, LLC. USA



Sockets	kg	Code	No.
☒ ● ITX 30 T25 T27 T30 T40 T45 T50	1.484	1509969	30 TX 20
☒ ● ITX 30 L T20 T25 T27 T30 T40 T45 T50			
☒ ● TX 30 E8 E10 E11 E12 E14			
☒ ● ITX 20 T8 T9 T10 T15 T20			
☒ ● TX 20 E4 E5 E6 E7			
☒ ☒ 2030			

Sets 10 (3/8") INCH

D 30 JAU

SOCKET SET 3/8"

12 pieces

- > With forged, tempered UD profile, hand-operated sockets
- > With accessories made from GEDORE vanadium steel 31CrV3
- > With reversible lever change ratchet
- > In GEDORE blue sheet steel case
- > Dimensions: 320 x 132 x 55 mm



Ratchet	Sockets	Accessories	kg	Code	No.
U-10 3093 U-10	D 30 1/4 5/16 11/32 3/8 7/16 1/2 9/16 5/8 11/16 3/4"	3090-5	2.0	2682907	D 30 JAU-10

D 30 GAU

SOCKET SET 3/8"

17 pieces

- > With forged, tempered UD profile, hand-operated sockets
- > With accessories made from GEDORE vanadium steel 31CrV3
- > With reversible lever change ratchet
- > In GEDORE blue sheet steel case
- > Dimensions: 320 x 210 x 55 mm



Ratchet	Sockets	Accessories	kg	Code	No.
U-10 3093 U-10	D 30 1/4 9/32 5/16 11/32 3/8 7/16 1/2 9/16 19/32 5/8 11/16 3/4"	3087 3090-5 -10 3095	2.6	6239540	D 30 GAU-10

Ratchets 10 (3/8")

3093 U-20 REVERSIBLE RATCHET 3/8"

- > Used throughout industry and the automotive world - and as well in confined spaces
- > Acc. to DIN 3122, ISO 3315
- > Small, drop shaped head for confined areas
- > Fine-toothed (60 teeth), with lever change and push-button release
- > Return angle 6 degrees
- > Non-slip 2-component handle with hanging hole
- > For hand-operated sockets and accessories with square drive as per DIN 3120 - C 10, ISO 1174, ball locking device
- > GEDORE vanadium steel 31CrV3, chrome-plated

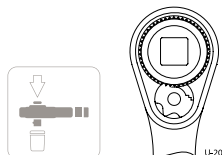

"	mm	°	mm	mm	kg	Code	No.
3/8	10	6	200	29.7	0.292	1556800	3093 U-20

3093 U-10 REVERSIBLE RATCHET 3/8"

- > Particularly for the demanding use experienced in industry and with utility vehicles
- > Acc. to DIN 3122, ISO 3315
- > With recessed lever change
- > Locks in the middle position: When the lever is flipped, it automatically engages for clockwise or counterclockwise operation
- > Push-button release
- > Return angle 11.25 degrees
- > Non-slip 2-component handle with hanging hole
- > For hand-operated sockets and accessories with square drive as per DIN 3120 - C 10, ISO 1174, ball locking device
- > GEDORE vanadium steel 31CrV3, chrome-plated

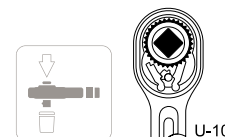

"	mm	°	mm	mm	kg	Code	No.
3/8	10	11,25	200	30.2	0.254	6236950	3093 U-10

3093 ALU-10 ALUMINIUM REVERSIBLE RATCHET 3/8"

- > Very lightweight, especially for work done above your head
- > Design spec. similar to DIN 3122, ISO 3315
- > Made from special-purpose drop-forged and hardened aluminium
- > The mechanism as in all U-10 ratchets is made from high quality steel
- > With recessed lever change
- > Locks in the middle position: When the lever is flipped, it automatically engages for clockwise or counterclockwise operation
- > Push-button release
- > Return angle 11.25 degrees
- > Non-slip 2-component handle with hanging hole
- > For hand-operated sockets and accessories with square drive as per DIN 3120 - C 10, ISO 1174, ball locking device
- > Extremely lightweight - just 160 g



"	mm	°	mm	mm	kg	Code	No.
3/8	10	11,25	200	30.2	0.160	1900005	3093 ALU-10

3093 U-3 REVERSIBLE RATCHET 3/8"

- > Especially for working in confined spaces, as in the automotive business
- > Acc. to DIN 3122, ISO 3315
- > With non-slip metal disc change, fine-toothed (72 teeth) and robust
- > Return angle 5 degrees
- > Non-slip 2-component handle with hanging hole
- > For hand-operated sockets and accessories with square drive as per DIN 3120 - C 10, ISO 1174, ball locking device
- > GEDORE vanadium steel 31CrV3, chrome-plated

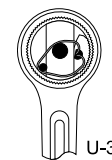

"	mm	°	mm	mm	kg	Code	No.
3/8	10	5	200	33.5	0.244	6237090	3093 U-3



3093 GU-3 SWIVEL HEAD REVERSIBLE RATCHET 3/8"

- > Especially for use in the automotive sector
- > Swivels through 180°, with joint lock
- > With non-slip metal disc change, fine-toothed (72 teeth) and robust
- > Return angle 5 degrees
- > Non-slip 2-component handle with hanging hole
- > Max. torque 200 N-m
- > For hand-operated sockets and accessories with square drive as per DIN 3120 - C 10, ISO 1174, ball locking device
- > GEDORE vanadium steel 31CrV3, chrome-plated



"	mm	°	mm	mm	kg	Code	No.
3/8	10	5	282	33.5	0.525	6237170	3093 GU-3

3093 Z-94 RATCHET HANDLE WITH COUPLER 3/8"

- > Used throughout industry and the automotive world
- > Acc. to DIN 3122, ISO 3315
- > With square coupler, medium-fine toothed, extremely rugged
- > Return angle 10 degrees
- > Non-slip 2-component handle with hanging hole
- > For hand-operated sockets and accessories with square drive as per DIN 3120 - C 10, ISO 1174, ball locking device
- > GEDORE vanadium steel 31CrV3, chrome-plated



"	mm	°	mm	mm	kg	Code	No.
3/8	10	10	200	18	0.223	6237680	3093 Z-94

VDE 3093 U

>573



3093 U-3 T RATCHET WITH T-HANDLE 3/8"

- > For progressing fast in confined spaces
- > Two-wing T-handle
- > Return angle 5 degrees
- > Ergonomic design for comfortable working
- > For hand-operated sockets and accessories with square drive as per DIN 3120 - C 10, ISO 1174, ball locking device
- > The danger of the tool canting, when carrying out work with extensions, is reduced by the central positioning of the square drive



"	mm	°	mm	kg	Code	No.
3/8	10	5	140	0.068	1973320	3093 U-3 T

Sockets 10 (3/8")

30 (MM) SOCKET 3/8"

hexagon UD profile

- > Acc. to DIN 3124, ISO 2725-1
 - > Square drive as per DIN 3120 - C 10, ISO 1174, with ball retention groove
 - > Hand-operated, knurled grip
 - > GEDORE vanadium steel 31CrV3, polished, chrome-plated
- * not standardised

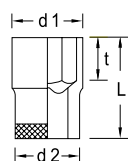

Ø mm	L	d ₁	d ₂	t		Code	No.
6	*	28	9.7	17.5	5.0	0.024	6230160 30 6
7		28	11.0	17.5	5.0	0.024	6230240 30 7
8		28	12.1	17.5	9.0	0.028	6230320 30 8
9		28	13.5	17.5	9.0	0.027	6230400 30 9
10		28	14.7	17.5	9.0	0.028	6230590 30 10
11		28	16.0	17.5	9.0	0.030	6233850 30 11
12		28	17.2	18.3	9.0	0.033	6233930 30 12
13		28	18.5	17.5	9.0	0.032	6234070 30 13
14		29	19.7	18.4	11.0	0.038	6234150 30 14
15		30	21.0	19.7	12.5	0.044	6234230 30 15
16		30	22.2	21.0	12.5	0.049	6234310 30 16
17		30	23.5	22.3	12.5	0.057	6234580 30 17
18		30	24.7	23.0	12.5	0.062	6234660 30 18
19		30	26.0	23.7	12.5	0.068	6234740 30 19
20		31	27.2	24.5	12.5	0.078	6234820 30 20
21		31	28.5	25.8	13.5	0.086	6234900 30 21
22		32	29.7	26.3	14.5	0.092	6235040 30 22
24	*	33	32.0	28.0	15.5	0.120	2194783 30 24

10 (AF) SOCKET 3/8"

hexagon UD profile

- > Square drive as per DIN 3120 - C 10, ISO 1174, with ball retention groove
- > Hand-operated, knurled grip
- > GEDORE vanadium steel 31CrV3, polished, chrome-plated

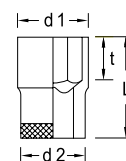

Ø AF	L	d ₁	d ₂	t		Code	No.
1/4	28	10.1	17.5	5.0	0.023	6232100	30 1/4AF
5/16	28	12.1	17.5	9.0	0.025	6232370	30 5/16AF
11/32	28	13.1	17.5	9.0	0.025	6232450	30 11/32AF
3/8	28	14.1	17.5	9.0	0.026	6232530	30 3/8AF
7/16	28	16.1	17.5	9.0	0.028	2101025	30 7/16AF
1/2	28	18.1	19.2	9.0	0.035	2101033	30 1/2AF
9/16	29	20.1	18.7	11.0	0.039	2101041	30 9/16AF
19/32	30	21.0	19.7	12.5	0.044	2101068	30 19/32AF
5/8	30	22.1	20.7	12.5	0.048	2101076	30 5/8AF
11/16	30	24.0	22.7	12.5	0.060	2101084	30 11/16AF
3/4	30	26.0	23.7	12.5	0.065	2101092	30 3/4AF
7/8	32	30.0	26.5	14.5	0.120	2101106	30 7/8AF



D 30 (MM) SOCKET 3/8"



bi-hexagon UD profile

- > Acc. to DIN 3124, ISO 2725-1
 - > Square drive as per DIN 3120 - C 10, ISO 1174, with ball retention groove
 - > Hand-operated, knurled grip
 - > GEDORE vanadium steel 31CrV3, polished, chrome-plated
- * not standardised

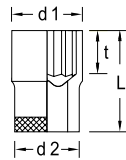

D 30 10

D 30 22

Ø mm	L	d ₁	d ₂	t		Code	No.
6	28	9.7	17.5	5.0	0.111	1845705	D 30 6
7	28	11.0	17.5	5.0	0.024	1845713	D 30 7
8	28	12.1	17.5	9.0	0.026	1845721	D 30 8
9	28	13.5	17.5	9.0	0.027	1845748	D 30 9
10	28	14.7	17.5	9.0	0.028	6229230	D 30 10
11	28	16.0	17.5	9.0	0.030	6230670	D 30 11
12	28	17.2	18.3	9.0	0.032	6230750	D 30 12
13	28	18.5	17.5	9.0	0.031	6230830	D 30 13
14	29	19.7	18.4	11.0	0.037	6230910	D 30 14
15	30	21.0	19.7	12.5	0.040	6231050	D 30 15
16	30	22.2	21.0	12.5	0.049	6231130	D 30 16
17	30	23.5	22.3	12.5	0.054	6231210	D 30 17
18	30	24.7	23.0	12.5	0.062	6231480	D 30 18
19	30	26.0	23.7	12.5	0.064	6231560	D 30 19
20	31	27.2	24.5	12.5	0.074	6231640	D 30 20
21	31	28.5	25.8	13.5	0.083	6231720	D 30 21
22	32	29.7	26.3	14.5	0.087	6231800	D 30 22
24	33	32.0	28.0	15.5	0.100	2194864	D 30 24

D 30 (AF) SOCKET 3/8"



bi-hexagon UD profile

- > Square drive as per DIN 3120 - C 10, ISO 1174, with ball retention groove
- > Hand-operated, knurled grip
- > GEDORE vanadium steel 31CrV3, polished, chrome-plated

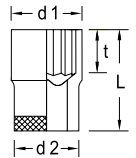

D 30 10

D 30 22

Ø "AF	L	d ₁	d ₂	t		Code	No.
1/4	28	10.1	17.5	5.0	0.050	2016613	D 30 1/4AF
9/32	28	11.1	17.5	5.0	0.020	2101009	D 30 9/32AF
5/16	28	12.1	17.5	5.0	0.020	1997122	D 30 5/16AF
11/32	28	13.1	17.5	9.0	0.026	2101017	D 30 11/32AF
3/8	28	14.1	17.5	9.0	0.010	1997130	D 30 3/8AF
13/32	28	15.0	17.5	9.0	0.030	1997149	D 30 13/32AF
7/16	28	16.1	17.5	9.0	0.027	6232610	D 30 7/16AF
1/2	28	18.1	19.2	9.0	0.034	6232880	D 30 1/2AF
9/16	29	20.1	18.7	11.0	0.036	6232960	D 30 9/16AF
19/32	30	21.0	19.7	12.5	0.039	6233180	D 30 19/32AF
5/8	30	22.1	20.7	12.5	0.044	6233260	D 30 5/8AF
11/16	30	24.0	22.7	12.5	0.053	6233340	D 30 11/16AF
3/4	30	26.0	23.7	12.5	0.061	6233420	D 30 3/4AF
25/32	31	27.0	24.3	12.5	0.075	1997157	D 30 25/32AF
13/16	31	28.0	25.3	12.5	0.080	1997165	D 30 13/16AF
7/8	32	30.0	26.5	14.5	0.082	6232020	D 30 7/8AF
15/16	33	31.9	28.0	15.5	0.110	1997173	D 30 15/16AF
1	33	33.9	30.0	15.5	0.120	1983296	D 30 1AF

D 30 L (MM) SOCKET 3/8"



bi-hexagon UD profile, long pattern

- > Acc. to DIN 3124, ISO 2725-1
- > Square drive as per DIN 3120 - C 10, ISO 1174, with ball retaining groove
- > Hand-operated, knurled grip
- > GEDORE vanadium steel 31CrV3, polished, chrome-plated

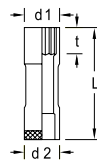

D 30 L 10

D 30 L 22

Ø mm	L	d ₁	d ₂	t		Code	No.
10	63.5	14.7	17.5	11	0.053	6258330	D 30 L 10
11	63.5	16.0	17.5	12	0.054	6258410	D 30 L 11
12	63.5	17.2	17.5	14	0.059	6258680	D 30 L 12
13	63.5	18.5	19.0	14	0.070	6258760	D 30 L 13
14	63.5	19.7	19.5	17	0.076	6258840	D 30 L 14
15	63.5	21.0	20.5	17	0.095	6258920	D 30 L 15
16	63.5	22.2	22.0	17	0.085	6259060	D 30 L 16
17	63.5	23.5	20.5	17	0.096	6259140	D 30 L 17
18	63.5	24.7	21.5	20	0.113	6259220	D 30 L 18
19	63.5	26.0	22.0	20	0.124	6259300	D 30 L 19
20	63.5	27.2	23.5	20	0.127	6259490	D 30 L 20
21	63.5	28.5	23.5	20	0.134	6259570	D 30 L 21
22	63.5	29.7	23.5	23	0.136	6259650	D 30 L 22

D 30 L (AF) SOCKET 3/8"



bi-hexagon UD profile, long pattern

- > Square drive as per DIN 3120 - C 10, ISO 1174, with ball retaining groove
- > Hand-operated, knurled grip
- > GEDORE vanadium steel 31CrV3, polished, chrome-plated

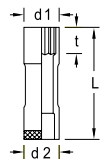

D 30 L 10

D 30 L 22

Ø "AF	L	d ₁	d ₂	t		Code	No.
3/8	63.5	14.1	17.5	11	0.051	6259730	D 30 L 3/8AF
7/16	63.5	16.1	17.5	12	0.053	6259810	D 30 L 7/16AF
1/2	63.5	18.1	19.0	14	0.065	6260070	D 30 L 1/2AF
9/16	63.5	20.1	19.5	17	0.073	6260150	D 30 L 9/16AF
5/8	63.5	22.1	22.0	17	0.092	6260230	D 30 L 5/8AF
11/16	63.5	24.0	20.5	17	0.090	6260310	D 30 L 11/16AF
3/4	63.5	26.0	22.0	20	0.109	6260580	D 30 L 3/4AF
13/16	63.5	28.3	23.5	20	0.132	6260660	D 30 L 13/16AF
7/8	63.5	30.0	23.5	23	0.134	6260740	D 30 L 7/8AF

DG 30 SWIVEL SOCKET 3/8"

bi-hexagon UD profile

- > Square drive as per DIN 3120 - C 10, ISO 1174, with ball retaining groove
- > Hand-operated
- > Chrome-vanadium steel 31CrV3, chrome-plated

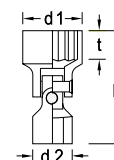

Ø mm	L	d ₁	d ₂	t		Code	No.
10	41.5	14.7	19	8.0	0.042	6240630	DG 30 10
13	42.5	18.5	19	9.0	0.050	6241520	DG 30 13
14	43.5	19.7	19	10.0	0.054	6241600	DG 30 14
15	45.5	21.0	19	11.0	0.048	6241790	DG 30 15
17	46.0	23.5	19	12.0	0.061	6241950	DG 30 17
18	46.0	24.7	19	12.5	0.063	6242410	DG 30 18
19	46.5	26.0	19	12.5	0.064	6242680	DG 30 19

TX 30 SOCKET 3/8"

for protruding TORX® head screws

- > Square drive as per DIN 3120 - C 10, ISO 1174, with ball retaining groove
- > Hand-operated, knurled grip
- > GEDORE vanadium steel 31CrV3, polished, chrome-plated
- > TORX® = reg. trademark of Acument Intellectual Properties, LLC. USA

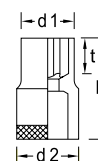

⊙	M	★ mm	L	d ₁	d ₂	t		Code	No.
E5	M4	4,73	28	7.2	17.5	5.0	0.025	6250270	TX 30 E5
E6	M5	5,74	28	8.5	17.5	5.0	0.025	6250350	TX 30 E6
E7	M6	6,16	28	9.5	17.5	5.5	0.025	6250430	TX 30 E7
E8	M6 - M7	7,52	28	10.8	17.5	6.0	0.027	6250510	TX 30 E8
E10	M8	9,42	28	13.2	17.5	9.0	0.029	6250780	TX 30 E10
E11	-	10,08	28	13.8	17.5	9.0	0.030	6250860	TX 30 E11
E12	M10	11,17	28	15.2	17.5	9.0	0.032	6250940	TX 30 E12
E14	M12	12,90	28	16.8	18.3	9.0	0.035	6251080	TX 30 E14

1500 ES-ITX 30

> 100

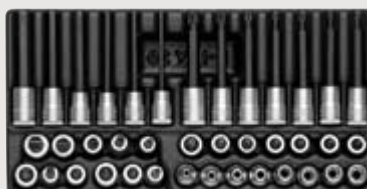

ITX 30 SCREWDRIVER BIT SOCKET 3/8"

10
3/8"

for recessed TORX® head screws

- > Square drive as per DIN 3120 - C 10, ISO 1174, with ball retaining groove
- > Hand-operated, knurled grip
- > Chrome-plated
- > With pressed-in pin in GEDORE vanadium special steel, gun-metal finish
- > TORX® = reg. trademark of Acument Intellectual Properties, LLC. USA

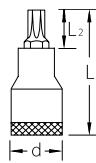

⊕	M	mm	L ₁	L ₂	d	kg	Code	No.
T20	M4 - M5	3,86	49	17	17.5	0.050	6246320	ITX 30 T20
T25	M4,5 - M5	4,43	49	17	17.5	0.051	6246830	ITX 30 T25
T27	M4,5 - M6	4,99	49	17	17.5	0.051	6247210	ITX 30 T27
T30	M6 - M7	5,52	49	17	17.5	0.051	6247560	ITX 30 T30
T40	M7 - M8	6,65	49	17	17.5	0.052	6247720	ITX 30 T40
T45	M8 - M10	7,82	49	17	17.5	0.053	6247800	ITX 30 T45
T50	M10	8,83	49	17	19.0	0.070	6247990	ITX 30 T50

ITX 30 L SCREWDRIVER BIT SOCKET 3/8"

10
3/8"

for recessed TORX® head screws, long pattern

- > Square drive as per DIN 3120 - C 10, ISO 1174, with ball retaining groove
- > Hand-operated, knurled grip
- > Chrome-plated
- > With pressed-in pin in GEDORE vanadium special steel, gun-metal finish
- > TORX® = reg. trademark of Acument Intellectual Properties, LLC. USA

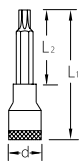

⊕	M	mm	L ₁	L ₂	d	kg	Code	No.
T20	M4 - M5	3,86	94	62	17.5	0.070	1394177	ITX 30 L T20
T25	M4,5 - M5	4,43	94	62	17.5	0.070	1394185	ITX 30 L T25
T27	M4,5 - M6	4,99	94	62	17.5	0.070	1394193	ITX 30 L T27
T30	M6 - M7	5,52	94	62	17.5	0.071	1394207	ITX 30 L T30
T40	M7 - M8	6,65	94	62	17.5	0.070	1394215	ITX 30 L T40
T45	M8 - M10	7,82	94	62	17.5	0.071	1394223	ITX 30 L T45
T50	M10	8,83	94	62	19.0	0.099	1394231	ITX 30 L T50

ITX 30 B SCREWDRIVER BIT SOCKET 3/8"

10
3/8"

for recessed TORX® head screws with pilot

- > Square drive as per DIN 3120 - C 10, ISO 1174, with ball retaining groove
- > Hand-operated, knurled grip
- > Chrome-plated
- > With pressed-in pin in GEDORE vanadium special steel, gun-metal finish
- > TORX® = reg. trademark of Acument Intellectual Properties, LLC. USA

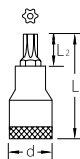

⊕	M	mm	L ₁	L ₂	d	Bore mm	kg	Code	No.
T20	M4 - M5	3,86	49	17	17.5	1,55 x 1,86	0.046	1440969	ITX 30 B T20
T25	M4,5 - M5	4,43	49	17	17.5	1,93 x 2,04	0.048	1440977	ITX 30 B T25
T27	M4,5 - M6	4,99	49	17	17.5	2,18 x 2,29	0.048	1440985	ITX 30 B T27
T30	M6 - M7	5,52	49	17	17.5	2,56 x 2,92	0.048	1440993	ITX 30 B T30
T40	M7 - M8	6,65	49	17	19.0	2,92 x 3,28	0.064	1429701	ITX 30 B T40
T45	M8 - M10	7,82	49	17	19.0	3,45 x 3,68	0.066	1441000	ITX 30 B T45
T50	M10	8,83	49	17	20.5	3,83 x 3,78	0.078	1441019	ITX 30 B T50

IS 30 SCREWDRIVER BIT SOCKET 3/8"

10
3/8"

for slotted head screws

- > Square drive as per DIN 3120 - C 10, ISO 1174, with ball retaining groove
- > Hand-operated, knurled grip
- > Chrome-plated
- > With pressed-in pin in GEDORE vanadium special steel, manganese-phosphated
- > Blade as per DIN ISO 2380-1, Form B

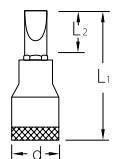

⊖	mm	mm	L ₁	L ₂	d	kg	Code	No.
5.5	1.0	55	27	17.5	0.040	6666100	IS 30 5,5x1	
6.5	1.2	55	27	17.5	0.039	1640895	IS 30 6,5x1,2	
8.0	1.2	55	23	17.5	0.054	6666290	IS 30 8x1,2	
10.0	1.6	55	23	19.0	0.072	6666370	IS 30 10x1,6	
12.0	2.0	55	23	20.5	0.083	1640909	IS 30 12x2	

IKS 30 SCREWDRIVER BIT SOCKET 3/8"

10
3/8"

for cross-head screws PH

- > Square drive as per DIN 3120 - C 10, ISO 1174, with ball retaining groove
- > Hand-operated, knurled grip
- > Chrome-plated
- > With pressed-in pin in GEDORE vanadium special steel, gun-metal finish
- > Tip as per DIN ISO 8764-1 PH

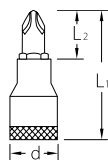

⊕ PH	L ₁	L ₂	d	⚖	Code	No.
1	55	27	17.5	0.041	6666610	IKS 30 1
2	55	23	17.5	0.052	6666880	IKS 30 2
3	55	23	19.0	0.070	6666960	IKS 30 3

IKS 30 PZD SCREWDRIVER BIT SOCKET 3/8"

10
3/8"

for cross-head screws Pozi PZ

- > Square drive as per DIN 3120 - C 10, ISO 1174, with ball retaining groove
- > Hand-operated, knurled grip
- > Chrome-plated
- > With pressed-in pin in GEDORE vanadium special steel, gun-metal finish
- > Tip as per DIN ISO 8764-1 PZ

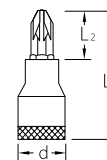

⊕ PZ	L ₁	L ₂	d	⚖	Code	No.
1	55	27	17.5	0.040	1640968	IKS 30 PZD 1
2	55	23	17.5	0.051	1640976	IKS 30 PZD 2
3	55	23	19.0	0.069	1640984	IKS 30 PZD 3

IN 30 (MM) SCREWDRIVER BIT SOCKET 3/8"

10
3/8"

for in-hex screws

- > Acc. to DIN 7422
 - > Square drive as per DIN 3120 - C 10, ISO 1174, with ball retaining groove
 - > Hand-operated, knurled grip
 - > Chrome-plated
 - > With pressed-in pin in GEDORE vanadium special steel, manganese-phosphated
- * not standardised

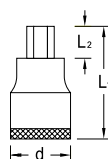

● mm	L ₁	L ₂	d	⚖	Code	No.
4	47	19	17.5	0.038	6241010	IN 30 4
5	47	19	17.5	0.039	6241280	IN 30 5
6	47	19	17.5	0.041	6241360	IN 30 6
7	*	47	17.5	0.041	1643037	IN 30 7
8	49	17	17.5	0.053	6241440	IN 30 8
10	49	17	19.0	0.073	6242920	IN 30 10

IN 30 (AF) SCREWDRIVER BIT SOCKET 3/8"

10
3/8"

for in-hex screws

- > Square drive as per DIN 3120 - C 10, ISO 1174, with ball retaining groove
- > Hand-operated, knurled grip
- > Chrome-plated
- > With pressed-in pin in GEDORE vanadium special steel, manganese-phosphated

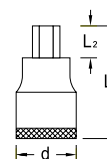

● AF	L ₁	L ₂	d	⚖	Code	No.
1/8	47	19	17.5	0.035	2195208	IN 30 1/8AF
5/32	47	19	17.5	0.040	2195232	IN 30 5/32AF
3/16	47	19	17.5	0.040	2195267	IN 30 3/16AF
1/4	47	19	17.5	0.049	1193422	IN 30 1/4AF
5/16	49	17	17.5	0.054	1193431	IN 30 5/16AF
3/8	49	17	19.0	0.050	1193449	IN 30 3/8AF

IN 30 L SCREWDRIVER BIT SOCKET 3/8"

10
3/8"

for in-hex screws, long pattern

- > Acc. to DIN 7422
- > Square drive as per DIN 3120 - C 10, ISO 1174, with ball retaining groove
- > Hand-operated, knurled grip
- > Chrome-plated
- > With pressed-in pin in GEDORE vanadium special steel, manganese-phosphated

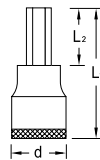

● mm	L ₁	L ₂	d	⚖	Code	No.
4	95	67	17.5	0.044	1510118	IN 30 L 4-95
5	95	67	17.5	0.048	1394347	IN 30 L 5-95
6	95	67	17.5	0.053	1394355	IN 30 L 6-95
7	95	67	17.5	0.058	1394363	IN 30 L 7-95
8	95	63	17.5	0.074	1394371	IN 30 L 8-95
10	95	63	19.0	0.105	1394398	IN 30 L 10-95

IN 30 LK SCREWDRIVER BIT SOCKET 3/8"

10
3/8"

with ball end, for in-hex screws, long pattern

- > Square drive as per DIN 3120 - C 10, ISO 1174, with ball retaining groove
- > Hand-operated, knurled grip
- > Chrome-plated
- > With pressed-in pin in GEDORE vanadium special steel, gun-metal finish
- > Total swivel angle approx. 15-20°

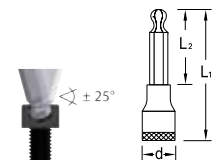

● mm	L ₁	L ₂	d	⚖	Code	No.
4	132	104	17.5	0.048	1505718	IN 30 LK 4
5	132	104	17.5	0.054	1505726	IN 30 LK 5
6	132	104	17.5	0.061	1505742	IN 30 LK 6
8	134	102	17.5	0.091	1505750	IN 30 LK 8
10	134	102	19.0	0.130	1505769	IN 30 LK 10

INX 30 SCREWDRIVER BIT SOCKET 3/8"

10
3/8"

for multi-point screws XZN

- > Acc. to DIN 2324
- > Square drive as per DIN 3120 - C 10, ISO 1174, with ball retaining groove
- > Hand-operated, knurled grip
- > Chrome-plated
- > With pressed-in pin in GEDORE vanadium special steel, manganese-phosphated
- > Tip as per DIN 2325

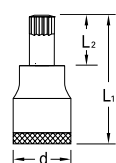
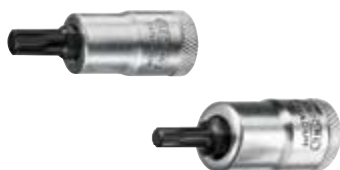

● M	L ₁	L ₂	d	⚖	Code	No.
M5	49	17	17.5	0.050	6242170	INX 30 5
M6	49	17	17.5	0.051	6242250	INX 30 6
M8	49	17	17.5	0.053	6242330	INX 30 8
M10	49	17	19.0	0.078	2194872	INX 30 10

INX 30 L SCREWDRIVER BIT SOCKET 3/8"

10
3/8"

for multi-point screws XZN, long pattern

- > Acc. to DIN 2324
- > Square drive as per DIN 3120 - C 10, ISO 1174, with ball retaining groove
- > Hand-operated, knurled grip
- > Chrome-plated
- > With pressed-in pin in GEDORE vanadium special steel, manganese-phosphated
- > Tip as per DIN 2325

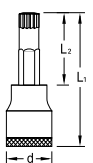

● M	L ₁	L ₂	d	⚖	Code	No.
M6	94	62	17.5	0.068	1394312	INX 30 L 6
M8	94	62	17.5	0.071	1394320	INX 30 L 8
M10	94	62	19.0	0.079	1394339	INX 30 L 10

Accessories 10 (3/8")

3084 SPEED BRACE 3/8"

- > Acc. to DIN 3122, ISO 3315
- > For hand-operated sockets and accessories with square drive as per DIN 3120, ISO 1174, with ball locking device
- > GEDORE vanadium steel 31CrV3, polished, chrome-plated
- > No. 3084 L for applications e.g. in the aviation sector



"	■	↳ mm ↳	⚖ kg	Code	No.
3/8	10	288	0.423	6236440	3084
3/8	10	463	0.568	1965395	3084 L

3098 SWIVEL HANDLE 3/8"

- > For hand-operated sockets and accessories with square drive as per DIN 3120, ISO 1174, with ball locking device
- > GEDORE vanadium steel 31CrV3, polished, chrome-plated

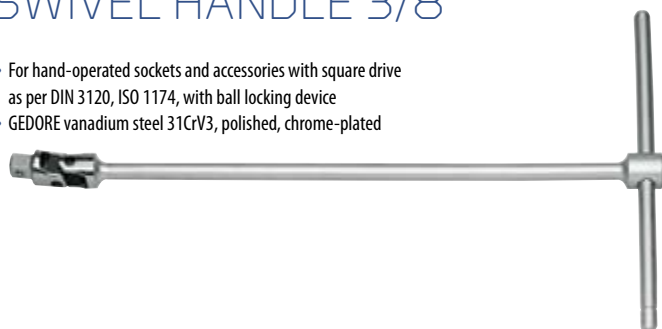

"	■	↳ mm ↳	⚖ kg	Code	No.
3/8	10	450	0.364	6182410	3098

3096 SWIVEL HANDLE 3/8"

- > Acc. to DIN 3122, ISO 3315
- > For hand-operated sockets and accessories with square drive as per DIN 3120, ISO 1174, with ball locking device
- > GEDORE vanadium steel 31CrV3, polished, chrome-plated



"	■	↳ mm ↳	⚖ kg	Code	No.
3/8	10	254	0.201	6238220	3096

3087 A SLIDING T BAR WITH RELEASE 3/8"

- > Secured against unintentional removal
- > GEDORE vanadium steel 31CrV3, polished, chrome-plated
- > Turn handle for easy locking and releasing
- > Accidental release when working is prevented because of the asymmetrical release point
- > Particularly useful for work in sensitive areas where certainty against loss is a theme
- > Examples: Aircraft engine, work in deep machine bodies
- > DBGm (German utility patent)



"	■	↳ mm ↳	⚖ kg	Code	No.
3/8	10	163	0.135	1871633	3087 A

3087 SLIDING T BAR 3/8"

- > Acc. to DIN 3122, ISO 3315
- > For hand-operated sockets and accessories with square drive as per DIN 3120, ISO 1174, with ball locking device
- > GEDORE vanadium steel 31CrV3, polished, chrome-plated



"	■	↳ mm ↳	⚖ kg	Code	No.
3/8	10	163	0.164	6236520	3087

3081 L-HANDLE 3/8"

- > Acc. to DIN 3122, ISO 3315
- > For hand-operated sockets and accessories with square drive as per DIN 3120, ISO 1174, with ball locking device
- > GEDORE vanadium steel 31CrV3, polished, chrome-plated



■ "	■	l- mm -l	⚖ kg	Code	No.
3/8	10	180	0.153	6236360	3081

3090 A EXTENSION 3/8"

with release

- > Easy access to deep-fitting screws in confined areas
- > No unintentional release of the socket from the extension due to safety ring
- > For hand-operated sockets and accessories with square drive as per DIN 3120, ISO 1174, with ball locking device



■ "	■	l- mm -l	⚖ kg	Code	No.
3/8	10	125	0.120	1932314	3090 A-5
3/8	10	250	0.210	1932322	3090 A-10

3090 M EXTENSION 3/8"

with magnet

- > For hand-operated sockets with square drive as per DIN 3120, ISO 1174, with ball locking device
- > The holding magnet securely fixes the screws or nuts in the socket
- > One-hand operation - using the socket the screw or nut can be immediately screwed in
- > Thanks to a spring mechanism the holding magnet is always in direct contact with the screw head. It ensures that the screw is centrally guided
- > A strong permanent magnet keeps hold of even large screws
- > Makes work easier particularly in confined spaces
- > Hot forged
- > GEDORE vanadium steel 31CrV3, polished



■ "	■	l- mm -l	⚖ kg	Code	No.
3/8	10	65	0.065	2960060	3090 M

3090 EXTENSION 3/8"

- > Acc. to DIN 3123, ISO 3316
- > For hand-operated sockets and accessories with square drive as per DIN 3120, ISO 1174, with ball locking device
- > GEDORE vanadium steel 31CrV3, polished, chrome-plated
- * not standardised

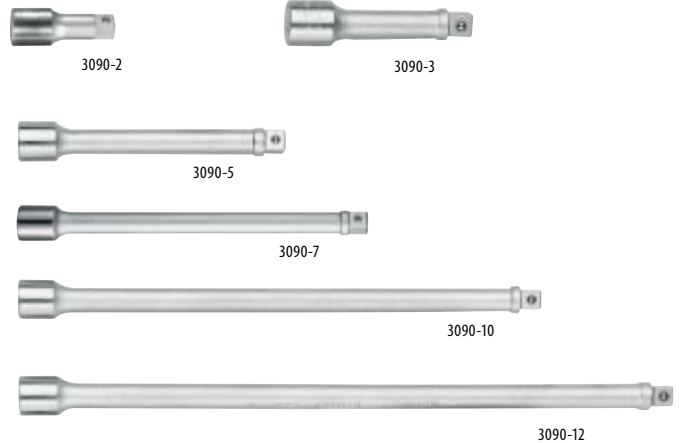

■ "	■	l- mm -l	⚖ kg	Code	No.
3/8	10	*	0.063	1476637	3090-2
3/8	10	76	0.093	6236600	3090-3
3/8	10	125	0.117	6236790	3090-5
3/8	10	*	0.164	1476645	3090-7
3/8	10	250	0.222	6236870	3090-10
3/8	10	*	0.287	6238570	3090-12
3/8	10	*	0.524	1476653	3090-20

3090 KR UNIVERSAL EXTENSION 3/8"

- > With ball end
- > For hand-operated sockets with square drive as per DIN 3120, ISO 1174, with ball locking device
- > The extension is able to pivot up to 15°
- > GEDORE vanadium steel 31CrV3, polished, chrome-plated

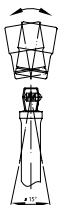

■ "	■	l- mm -l	⚖ kg	Code	No.
3/8	10	76	0.080	1874381	3090 KR-3
3/8	10	125	0.108	1845756	3090 KR-5
3/8	10	250	0.197	1845764	3090 KR-10

VDE 3090

>573



3095 UNIVERSAL JOINT 3/8"

- > Acc. to DIN 3123, ISO 3316
- > For hand-operated sockets and accessories with square drive as per DIN 3120, ISO 1174, with ball locking device

- > GEDORE vanadium steel 31CrV3, polished, chrome-plated



"	"	"	"	mm	kg	Code	No.
3/8	10	3/8	10	50	0.053	6238140	3095

3094 COUPLER 3/8"

- > Acc. to DIN 3122, ISO 3316
- > For hand-operated sockets and accessories with square drive as per DIN 3120, ISO 1174, with ball locking device

- > GEDORE vanadium steel 31CrV3, polished, chrome-plated

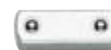

"	"	mm	kg	Code	No.
3/8	10	29	0.020	6237760	3094

3019 CONVERTOR 3/8" TO 1/2"

- > Acc. to DIN 3123, ISO 3316
- > For hand-operated sockets and accessories with square drive as per DIN 3120, ISO 1174, with ball locking device

- > GEDORE vanadium steel 31CrV3, polished, chrome-plated



"	"	"	"	mm	kg	Code	No.
3/8	10	1/2	12.5	35	0.053	6236010	3019

3020 REDUCER 3/8" TO 1/4"

- > Acc. to DIN 3123, ISO 3316
- > For hand-operated sockets and accessories with square drive as per DIN 3120, ISO 1174, with ball locking device

- > GEDORE vanadium steel 31CrV3, polished, chrome-plated



"	"	"	"	mm	kg	Code	No.
3/8	10	1/4	6.3	28	0.026	6236280	3020

SL 3014 TOOL HOLDING RAIL, MAGNETIC 3/8"

empty

- > External squares to take 14 standard commercial 10 mm (3/8") sockets
- > Two female square adaptors to take ratchets, sliding T bars, extensions etc.
- > A strong magnet securely holds the socket rail to ferrous metals
- > Additional holes are provided for wall mounting the socket rail or attaching to non-ferrous materials
- > The sockets are securely locked by the ball at the square-drive end by turning them 90°

- > It is a simple matter to "unlock" and remove the sockets, by turning them 90° in the opposing direction
- > Delivery without tools



mm	mm	kg	Code	No.
380	33	0.355	1761080	SL 2013



VH 30 SPRING STEEL SOCKET RAIL 3/8"

- > For 14 3/8" sockets
- > Delivery without tools



mm	kg	Code	No.
405	0.067	5164810	VH 30



12.5 (1/2") square drive

12.5 1/2"

Sets 12.5 (1/2") METRIC

12.5 1/2"

19 KMU / D 19 KMU
SOCKET SET 1/2"

13 pieces

- > With forged, tempered hexagon (no.19) or UD profile sockets (no. D 19), hand-operated
- > With accessories made from GEDORE vanadium steel 31CrV
- > With robust lever-change reversible ratchet, with push-button release
- > In GEDORE blue sheet steel case
- > Dimensions: 320 x 132 x 55 mm



12.5
1/2"
mm

Ratchet	Sockets	Accessories	Weight	Code	No.
U-20 1993 U-20	19 10 12 13 14 15 16 17 18 19 22 24	1990-5	2.9	2545810	19 KMU-20
U-20 1993 U-20	D 19 10 12 13 14 15 16 17 18 19 22 24	1990-5	2.9	2545829	D 19 KMU-20

19 JMU / D 19 JMU
SOCKET SET 1/2"

19 pieces

- > With forged, tempered hexagon (no.19) or UD profile sockets (no. D 19), hand-operated
- > With accessories made from GEDORE vanadium steel 31CrV3
- > With fine toothed, dial change ratchet
- > In GEDORE blue sheet steel case
- > Dimensions: 320 x 210 x 55 mm



12.5
1/2"
mm

Ratchet	Sockets	Accessories	Weight	Code	No.
U-3 1993 U-3	19 8 9 10 11 12 13 14 15 16 17 18 19 21 22 24	1990-5 -10 1995	3.7	2682842	19 JMU-3
U-3 1993 U-3	D 19 8 9 10 11 12 13 14 15 16 17 18 19 21 22 24	1990-5 -10 1995	3.7	2682850	D 19 JMU-3

19 EMU / D 19 EMU SOCKET SET 1/2"

23 pieces

- > With forged, tempered hexagon (no.19) or UD profile sockets (no. D 19), hand-operated
- > With accessories made from GEDORE vanadium steel 31CrV3
- > Set U-20 with robust lever-change reversible ratchet, with push-button release
- > Set U-3 with fine toothed, dial change ratchet
- > In GEDORE blue sheet steel case
- > Dimensions: 425 x 277 x 55 mm

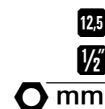

Ratchet	Sockets	Accessories	kg	Code	No.
U-20 1993 U-20	19 8 9 10 11 12 13 14 15 16 17 18 19 21 22 24 27 30 32	1987 1990-5 -10 1995	6.8	2545837	19 EMU-20
U-20 1993 U-20	D 19 8 9 10 11 12 13 14 15 16 17 18 19 21 22 24 27 30 32	1987 1990-5 -10 1995	6.7	2545845	D 19 EMU-20
U-3 1993 U-3	19 8 9 10 11 12 13 14 15 16 17 18 19 21 22 24 27 30 32	1987 1990-5 -10 1995	6.8	2545853	19 EMU-3
U-3 1993 U-3	D 19 8 9 10 11 12 13 14 15 16 17 18 19 21 22 24 27 30 32	1987 1990-5 -10 1995	6.6	2545861	D 19 EMU-3

19 TMU / D 19 TMU SOCKET SET 1/2"

25 pieces

- > With forged, tempered hexagon (no.19) or UD profile sockets (no. D 19), hand-operated
- > With accessories made from GEDORE vanadium steel 31CrV3
- > With reversible lever change ratchet, with push-button release
- > In GEDORE blue sheet steel case
- > Dimensions: 425 x 277 x 55 mm



Ratchet	Sockets	Accessories	kg	Code	No.
U-10 1993 U-10T	19 10 11 12 13 14 15 16 17 18 19 21 22 23 24 26 27 28 30 32	1985 1987 1990-5 -10 1995	7.8	6151880	19TMU-10
U-10 1993 U-10T	D 19 10 11 12 13 14 15 16 17 18 19 21 22 23 24 26 27 28 30 32	1985 1987 1990-5 -10 1995	7.7	6151960	D 19TMU-10











19 VMU / D 19 VMU SOCKET SET 1/2"

28 pieces

- > With forged, tempered hexagon (no.19) or UD profile sockets (no. D 19), hand-operated
- > With accessories made from GEDORE vanadium steel 31CrV3
- > With reversible lever change ratchet, with push-button release
- > In GEDORE blue sheet steel case
- > Dimensions: 425 x 277 x 55 mm

12.5
1/2"
mm



Ratchet	Sockets	Accessories		Code	No.
 1993 U-10 T	 19 10 11 12 13 14 15 16 17 18 19 20 21 22 23 24 26 27 28 30 32 33 34 36	 1987  1990-5 -10  1995	7.8	2682869	19 VMU-10
 1993 U-10 T	 D 19 10 11 12 13 14 15 16 17 18 19 20 21 22 23 24 26 27 28 30 32 33 34 36	 1987  1990-5 -10  1995	7.8	2682877	D 19 VMU-10







19 LMU-10 SOCKET SET 1/2"

31 pieces

- > With forged, tempered UD profile sockets, hand-operated
- > Impact sockets with protective sleeve
- > With accessories made from GEDORE vanadium steel 31CrV3
- > With reversible lever change ratchet, with push-button release
- > In GEDORE blue sheet steel case
- > Dimensions: 425 x 277 x 55 mm

12.5
1/2"
mm



Ratchet	Sockets	Accessories		Code	No.
 1993 U-10 T	 19 10 11 12 13 14 15 16 17 18 19 21 22 24 27 32 36  D 19 L 10 12 13 14 15 16 18 24  K 19 LS 17 19 21 22	 1990-5 -10	8.3	1806033	19 LMU-10

19 RMU-10 SOCKET SET 1/2"

32 pieces

- > With forged, tempered hexagon UD profile sockets, hand-operated
- > With combination ratchet spanner no. 7 R for ratchet loosening and fast tightening
- > With accessories made from GEDORE vanadium steel 31CrV3
- > With reversible lever change ratchet, with push-button release
- > In GEDORE blue sheet steel case
- > Dimensions: 425 x 277 x 55 mm

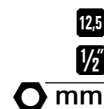

Ratchet	Sockets	Accessories		Code	No.
U-10 1993 U-10 T	19 8 10 11 12 13 14 15 16 17 18 19 21 22 24 27 32 36 7 R 8 10 11 12 13 14 15 16 17 18 19	1990-5 -10 1995	7.7	6145210	19 RMU-10

IN 19 Q SCREWDRIVER BIT SOCKET SET 1/2"

11 pieces

- > For in-hex screws
- > In GEDORE blue sheet steel case
- > Dimensions: 320 x 210 x 55 mm

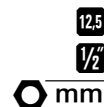

Ratchet	Sockets	Accessories		Code	No.
U-10 1993 U-10 T	IN 19 5 6 7 8 9 10 12 14 17	1990-10	3.3	6156920	IN 19 Q

19 IMU / D 19 IMU SOCKET SET 1/2"

27 pieces

- > With forged, tempered hexagon (no.19) or UD profile sockets (no. D 19), hand-operated
- > With accessories made from GEDORE vanadium steel 31CrV3
- > With reversible lever change ratchet, with push-button release
- > In GEDORE blue sheet steel case
- > Dimensions: 425 x 277 x 55 mm

12,5
1/2"
mm



Ratchet	Sockets	Accessories	kg	Code	No.
U-10 1993 U-10 T	19 10 11 12 13 14 15 17 19 22 24 27 30 IN 19 5 6 7 8 10 12 14 IS 19 8 10 IKS 19 2 3	1990-5 -10 1995	6.9	6139750	19 IMU-10
U-10 1993 U-10 T	D 19 10 11 12 13 14 15 17 19 22 24 27 30 IN 19 5 6 7 8 10 12 14 IS 19 8 10 IKS 19 2 3	1990-5 -10 1995	6.8	6140090	D 19 IMU-10

ITX 19 TXU-20 SOCKET SET 1/2"

25 pieces

- > For protruding and recessed TORX® screws
- > In GEDORE blue sheet steel case
- > Dimensions: 425 x 277 x 55 mm
- > TORX® = reg. trademark of Acument Intellectual Properties, LLC. USA

12,5
1/2"
12,5
1/2"







Ratchet	Sockets	Accessories	kg	Code	No.
U-20 1993 U-20	ITX 19 T20 T25 T27 T30 T40 T45 T50 T55 T60 TX 19 E10 E11 E12 E14 E16 E18 E20 E24 TX 4 E6xE8 E10xE12 E14xE18 E20xE24	1990-5 -10 1995	6.4	2546019	ITX 19 TXU-20

ITX 19 INU-20 SOCKET SET 1/2"

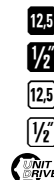
42 pieces

- > For protruding and recessed TORX® screws and in-hex screws
- > In GEDORE blue sheet steel case
- > Dimensions: 425 x 277 x 55 mm
- > TORX® = reg. trademark of Acument Intellectual Properties, LLC. USA



















Ratchet	Sockets	Accessories		Code	No.
 1993 U-20	<ul style="list-style-type: none"> ○ 19 10 11 12 13 14 15 16 17 18 19 21 22 24 27 30 32 ● IN 19 5 6 7 8 9 10 12 14 17 ⊕ TX 19 E10 E12 E14 E16 E18 E20 E24 ⊕ ITX 19 T20 T25 T27 T30 T40 T45 T50 T55 T60 	 1990 KR-10	8.2	2546000	ITX 19 INU-20

19 V20U-10 SOCKET SET 1/4"-1/2"

50 pieces

- > With forged, tempered hexagon or UD profile sockets, hand-operated
- > With accessories made from GEDORE vanadium steel 31CrV3
- > 1/4" with fine toothed, dial change ratchet U-3
- > 1/2" with reversible lever change ratchet U-10 T
- > In GEDORE blue sheet steel case
- > Dimensions: 425 x 277 x 55 mm



Ratchet	Sockets	Accessories		Code	No.
 1993 U-10 T	<ul style="list-style-type: none">  ○ 19 10 11 12 13 14 15 17 19 22 24 27 30  ● IN 19 7 8 10 12 14  ⊖ IS 19 8 10  ⊕ IKS 19 3 	<ul style="list-style-type: none">  1990-5 -10  1995  2098  2090-2 -4  2087  2095 	7.2	6157490	19V20U-10
 2093 U-3	<ul style="list-style-type: none">  ○ 20 4 4,5 5 5,5 6 7 8 9 10 11 13  ● IN 20 3 4 5 6  ⊖ IS 20 4 5,5 6,5  ⊕ IKS 20 1 2 				

19 V20U-20

SOCKET SET 1/4"-1/2"

81 pieces

- > With forged, tempered sockets, hand-operated
- > With accessories made from GEDORE vanadium steel 31CrV3
- > With robust lever-change reversible ratchet, with push-button release
- > In GEDORE blue sheet steel case
- > Dimensions: 425 x 277 x 55 mm

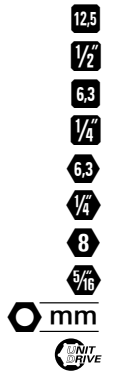

Ratchet	Sockets	Accessories	kg	Code	No.
1/2" U-20 1993 U-20	1/2" 19 10 11 12 13 14 15 16 17 18 19 21 22 24 27 30 32 36	1/2" 1990 KR-5 -10	7.4	1550691	19V20U-20
1/4" U-20 2093 U-20	1/4" D 20 4 5 5,5 6 7 8 9 10 11 12 13 680 4 4,5 5,5 6,5 685 2 2,5 3 4 5 6 8 685 X 5 6 8 687 TX T10 T15 T20 T25 T27 T30 T40 690 1 2 3 690 PZD 1 2 3 885 3 4 5 6 8 10 885 X 5 6 8 10 12 887 TX T27 T30 T40 T45 T50	1/4" 2090-4 1/4" 2095 620 676 699 KB 819			

D 19 L-015

SOCKET SET 1/2"

15 pieces

- > With forged, tempered UD profile sockets, hand-operated
- > In GEDORE blue sheet steel case
- > Dimensions: 320 x 210 x 55 mm

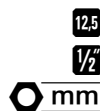

IN 19 PM

SCREWDRIVER BIT SOCKET SET 1/2"

9 pieces

- > For in-hex screws
- > In GEDORE blue sheet steel case
- > Dimensions: 281 x 79 x 35 mm



Sockets	kg	Code	No.
D 19 L 10 12 13 14 15 16 17 18 19 21 22 24 27 30 32	4.3	2190214	D 19 L-015

Sockets	kg	Code	No.
IN 19 S 6 7 8 9 10 12 14 17	1.362	6156250	IN 19 PM

INX 19 PM SCREWDRIVER BIT SOCKET SET 1/2"

9 pieces

- > For slotted, cross-head and multi-point screws
- > In GEDORE blue sheet steel case
- > Dimensions: 281 x 79 x 35 mm



Sockets		Code	No.
● INX 19 5 6 8 10 12	1.3	6150050	INX 19 PM
⊕ IKS 19 2 3			
⊖ IS 19 12 16			

IN 19 LKM SCREWDRIVER BIT SOCKET SET 1/2"

15 pieces

- > For in-hex screws, short and long
- > In GEDORE blue sheet steel case
- > Dimensions: 320 x 210 x 55 mm



Sockets		Code	No.
● IN 19 5 6 7 8 9 10 12 14 17	3.2	6129360	IN 19 LKM
● IN 19 L 5-90 6-90 8-90 10-140 12-140 14-140			

ITX 19 PM / ITX 19 B-PM SCREWDRIVER BIT SOCKET SET 1/2"

9 pieces

- > ITX 19 PM: for recessed TORX® head screws
- > ITX 19 B-PM: for recessed TORX® head screws with pilot
- > In GEDORE blue sheet steel case
- > Dimensions: 281 x 79 x 35 mm
- > TORX® = reg. trademark of Acument Intellectual Properties, LLC. USA



Sockets		Code	No.
● ITX 19 T20 T25 T27 T30 T40 T45 T50 T55 T60	1.2	6158970	ITX 19 PM
● ITX 19 B T20 T25 T27 T30 T40 T45 T50 T55 T60	1.3	1394894	ITX 19 B-PM

TX 19 E-09 SOCKET SET 1/2"

9 pieces

- > For protruding TORX® screws
- > With convertor 3/8" to 1/2"
- > In plastic case
- > Dimensions: 200 x 120 x 38 mm
- > TORX® = reg. trademark of Acument Intellectual Properties, LLC. USA



Sockets		Code	No.
● TX 19 E10 E11 E12 E14 E16 E18 E20 E24	1.0	6265970	TX 19 E-09
Ⓢ 3019			

ITX 19 TX-017 SCREWDRIVER BIT SOCKET SET 1/2"

17 pieces

- > For protruding and recessed TORX® screws
- > In GEDORE blue sheet steel case
- > Dimensions: 320 x 210 x 55 mm
- > TORX® = reg. trademark of Acument Intellectual Properties, LLC. USA



12,5
1/2"

ITX 19 LKP SCREWDRIVER BIT SOCKET SET 1/2"

18 pieces

- > For recessed TORX® screws, short and long
- > In GEDORE blue sheet steel case
- > Dimensions: 320 x 210 x 55 mm
- > TORX® = reg. trademark of Acument Intellectual Properties, LLC. USA



12,5
1/2"

Sockets		Code	No.
ITX 19 T20 T25 T27 T30 T40 T45 T50 T55 T60	2.8	6129520	ITX 19 TX-017
TX 19 E10 E11 E12 E14 E16 E18 E20 E24			

Sockets		Code	No.
ITX 19 T20 T25 T27 T30 T40 T45 T50 T55 T60	3.2	6138510	ITX 19 LKP
ITX 19 L T20 T25 T27 T30 T40 T45 T50 T55 T60			

19 TX 20 SCREWDRIVER BIT SOCKET SET 1/2" + 1/4"

34 pieces

- > 1/4" and 1/2" sockets for protruding and recessed TORX® screws
- > In GEDORE blue sheet steel case
- > Dimensions: 320 x 210 x 55 mm
- > TORX® = reg. trademark of Acument Intellectual Properties, LLC. USA



6,3
1/4"
12,5
1/2"

Sockets		Code	No.
ITX 19 T40 T45 T50 T55 T60	3.6	6129440	19TX 20
ITX 19 LT20 T25 T27 T30 T40 T45 T50 T55 T60			
TX 19 E12 E14 E16 E18 E20 E24			
ITX 20 T8 T9 T10 T15 T20 T25 T27 T30			
TX 20 E4 E5 E6 E7 E8 E10			

Sets 12.5 (1/2") INCH

D 19 WAU-20
SOCKET SET 1/2"

31 pieces





- > With forged, tempered UD profile sockets, hand-operated
- > With accessories made from GEDORE vanadium steel 31CrV3
- > With robust lever-change reversible ratchet, with push-button release
- > In GEDORE blue sheet steel case
- > Dimensions: 425 x 277 x 55 mm



12.5

1/2"

"AF"

Ratchet	Sockets	Accessories		Code	No.
 1993 U-20	 D 19 5/16 11/32 3/8 13/32 7/16 1/2 9/16 19/32 5/8 11/16 3/4 25/32 13/16 7/8 15/16 1" 1.1/16 1.1/8 1.3/16 1.1/4" H 42 EL-88 A	 1990-5 -10  1995	6.9	2546027	D 19 WAU-20

IN 19 PA
SCREWDRIVER BIT SOCKET SET 1/2"

9 pieces



- > For in-hex screws
- > In GEDORE blue sheet steel case
- > Dimensions: 281 x 79 x 35 mm



12.5

1/2"

"AF"

Sockets		Code	No.
 IN 19 3/16 7/32 1/4 9/32 5/16 3/8 1/2 9/16 5/8"	1.328	6156410	IN 19 PA

Sets 12.5 (1/2") MM+INCH

D 19 XMAU-20 SOCKET SET 1/2"

31 pieces

- > With forged, tempered UD profile sockets, hand-operated
- > With accessories made from GEDORE vanadium steel 31CrV3
- > With robust lever-change reversible ratchet, with push-button release
- > In GEDORE blue sheet steel case
- > Dimensions: 425 x 277 x 55 mm

12.5
1/2"
mm
"AF"



Ratchet	Sockets	Accessories		Code	No.
U-20 1993 U-20	D 19 11 13 14 17 19 22 24 27 30 32 D 19 3/8 13/32 7/16 1/2 9/16 19/32 5/8 11/16 3/4 25/32 13/16 7/8 15/16 1" 1.1/16 1.1/8"	1987 1990-5 -10 1995	7.6	2546043	D 19 XMAU-20

Sets 12.5 (1/2") WITHWORTH

D 19 YWU-20 SOCKET SET 1/2"

14 pieces

- > With forged, tempered bi-hexagon sockets, hand-operated
- > With accessories made from GEDORE vanadium steel 31CrV3
- > With robust lever-change reversible ratchet, with push-button release
- > In GEDORE blue sheet steel case
- > Dimensions: 320 x 210 x 55 mm

12.5
1/2"
Whitw.



Ratchet	Sockets	Accessories		Code	No.
U-20 1993 U-20	D 19 3/16 1/4 5/16 3/8 7/16 1/2 9/16 5/8 11/16 3/4W	1990-5 -10 1995	3.8	2546035	D 19 YWU-20

SK 19 MM

SK RATCHET AND SOCKETS

SK = SOCKET SHORT

- > Especially for working in confined spaces
- > Sockets and ratchet with tubular section for taking up long thread bolts
- > A compact and inner-cavity hexagonal system as the connection between ratchet and socket
- > The sockets are inserted into the ratchet hexagon female drive

- > The drive length is concealed inside the ratchet and shortens the projecting part of the socket by 50 % as against the traditional system
- > Sockets and ratchet hot-drop forged of GEDORE steel
- > Sockets from 10 to 24 mm



19 SKU-20 SOCKET SET



14 pieces

- > With forged, tempered, hand-operated sockets no. 19 SK with hexagon drive 18.95 mm
- > With reversible lever change ratchet with in-hex drive 19 mm
- > Small, drop shaped head for confined areas
- > Fine-toothed, return angle 6 degrees
- > Non-slip 2-component handle with hanging hole
- > In GEDORE blue sheet steel case
- > Dimensions: 320 x 132 x 55 mm



Ratchet

Sockets



Code

No.

U-20 1993 U-20 SK

19 SK 10 11 12 13 14 15
16 17 18 19 21 22 24

2.6

2521563

19 SKU-20

1993 U-20 SK REVERSIBLE RATCHET

- > Especially for thread bolts and working in confined spaces
- > With hexagon drive
- > Torques specification required to standard DIN 3122 is exceeded
- > Small, drop shaped head for confined areas
- > Fine-toothed (60 teeth), with lever change
- > Return angle 6 degrees
- > Non-slip 2-component handle with hanging hole
- > For hand-operated sockets with hexagon no. 19 SK
- > GEDORE vanadium steel 31CrV3, chrome-plated

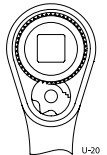

Hexagon	Return angle	Length	Head width	Weight	Code	No.
19	6°	270	21	0.510	2219492	1993 U-20 SK

19 SK SOCKET



hexagon, short pattern

- > With hexagon drive size 18.95 mm
- > For use with reversible ratchet no. 1993 U-20 SK
- > Torques specification required to standard DIN 3124 is exceeded
- > GEDORE steel 42CrMo4, chrome-plated

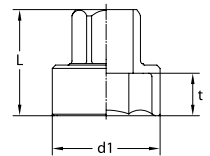

Code	L	d ₁	t	Weight	Code	No.
10	24.0	15.5	6.0	0.040	2521539	19 SK 10
11	24.0	16.7	6.0	0.040	2521547	19 SK 11
12	25.0	18.0	7.0	0.040	2521555	19 SK 12
13	25.0	19.2	7.0	0.040	2225875	19 SK 13
14	25.0	20.5	7.0	0.040	2225883	19 SK 14
15	26.5	21.7	8.5	0.040	2225891	19 SK 15
16	26.5	22.5	8.5	0.091	2225905	19 SK 16
17	27.0	24.0	8.5	0.040	2225913	19 SK 17
18	31.0	25.5	11.0	0.040	2225921	19 SK 18

Code	L	d ₁	t	Weight	Code	No.
19	31.0	26.7	11.0	0.081	2225948	19 SK 19
21	33.0	29.2	13.0	0.040	2225964	19 SK 21
22	33.0	30.5	13.0	0.121	2225972	19 SK 22
24	33.0	33.0	13.0	0.151	2225980	19 SK 24

VDE 1993 U

>575



Ratchets 12.5 (1/2")

1993 U-20 G REVERSIBLE RATCHET 1/2"

with offset handle

- > Used throughout industry and the automotive world - and as well in confined spaces
- > Torque acc. to DIN 3122, ISO 3315
- > Handle offset for barely accessible places
- > Reduces the risk of injury to the fingers when working on flat surfaces
- > Small, drop shaped head for confined areas
- > Fine-toothed (60 teeth), with lever change and push-button release
- > Return angle 6 degrees
- > Non-slip 2-component handle with hanging hole
- > For hand-operated sockets and accessories with square drive as per DIN 3120 - C 12.5, ISO 1174, ball locking device
- > GEDORE vanadium steel 31CrV3, chrome-plated

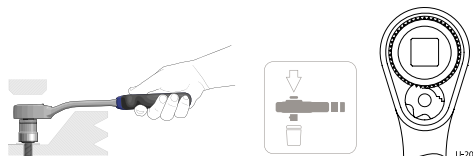

"	mm	°	mm	mm	kg	Code	No.
1/2	12.5	6	270	37.5	0.540	2746786	1993 U-20 G

1993 U-20 REVERSIBLE RATCHET 1/2"

- > Used throughout industry and the automotive world - and as well in confined spaces
- > Acc. to DIN 3122, ISO 3315
- > Small, drop shaped head for confined areas
- > Fine-toothed (60 teeth), with lever change and push-button release
- > Return angle 6 degrees
- > Non-slip 2-component handle with hanging hole
- > For hand-operated sockets and accessories with square drive as per DIN 3120 - C 12.5, ISO 1174, ball locking device
- > GEDORE vanadium steel 31CrV3, chrome-plated

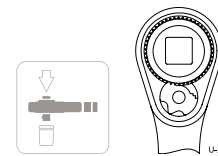

"	mm	°	mm	mm	kg	Code	No.
1/2	12.5	6	270	37.5	0.536	1436686	1993 U-20

1993 U-10 L REVERSIBLE RATCHET 1/2"

long pattern

- > For an increase in torque, long design
- > Acc. to DIN 3122, ISO 3315
- > With recessed lever change
- > Push-button release
- > Return angle 7.5 degrees
- > Non-slip 2-component handle with hanging hole
- > Locks in the middle position: When the lever is flipped, it automatically engages for clockwise or anti-clockwise operation
- > For hand-operated sockets and accessories with square drive as per DIN 3120 - C 12.5, ISO 1174, ball locking device
- > GEDORE vanadium steel 31CrV3, chrome-plated

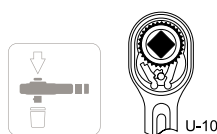

"	mm	°	mm	mm	kg	Code	No.
1/2	12.5	7,5	350	41	0.696	6154550	1993 U-10 L

1993 U-10 T REVERSIBLE RATCHET 1/2"

- > Particularly for the demanding use experienced in industry and with utility vehicles
- > Acc. to DIN 3122, ISO 3315
- > With recessed lever change
- > Push-button release
- > Return angle 7.5 degrees
- > Non-slip 2-component handle with hanging hole
- > Locks in the middle position: When the lever is flipped, it automatically engages for clockwise or anti-clockwise operation
- > For hand-operated sockets and accessories with square drive as per DIN 3120 - C 12.5, ISO 1174, ball locking device
- > GEDORE vanadium steel 31CrV3, chrome-plated

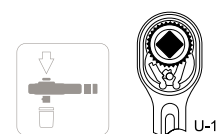

"	mm	°	mm	mm	kg	Code	No.
1/2	12.5	7,5	270	39	0.598	6142620	1993 U-10 T



LIGHTWEIGHT POWER PACK WITH 100% PERFORMANCE!

- > Particularly suited for tiring overhead work!
- > Its low weight goes easy particularly on one's joints
- > Lightweight yet still of high-strength
- > As with all U-10 ratchets, a mechanism of steel for guaranteed torque transfer as per DIN 3122
- > Hot-drop forged
- > Tough and hard from complex thermal finishing of the aluminium/zinc/magnesium/copper alloy after the demanding forging process

1993 ALU-10 ALUMINIUM REVERSIBLE RATCHET 1/2"

- > Very lightweight, especially for work done above your head
- > Design spec. similar to DIN 3122, ISO 3315
- > Made from special-purpose drop-forged and hardened aluminium
- > The mechanism as in all U-10 ratchets is made from high-quality steel
- > With recessed lever change
- > Push-button release
- > Return angle 7.5 degrees
- > Non-slip 2-component handle with hanging hole
- > Locks in the middle position: When the lever is flipped, it automatically engages for clockwise or anti-clockwise operation
- > For hand-operated sockets and accessories with square drive as per DIN 3120 - C 12.5, ISO 1174, ball locking device
- > Extremely lightweight - just 340 g



1/2"	mm	°	mm	mm	kg	Code	No.
1/2	12.5	7,5	270	39	0.340	6142700	1993 ALU-10

1993 U-3 REVERSIBLE RATCHET 1/2"

- > Especially for working in confined spaces, as in the automotive business
- > Acc. to DIN 3122, ISO 3315
- > With non-slip metal disc change, fine-toothed (72 teeth) and robust
- > Return angle 5 degrees
- > Non-slip 2-component handle with hanging hole
- > For hand-operated sockets and accessories with square drive as per DIN 3120 - C 12.5, ISO 1174, ball locking device
- > GEDORE vanadium steel 31CrV3, chrome-plated



1/2"	mm	°	mm	mm	kg	Code	No.
1/2	12.5	5	270	40.5	0.476	6144240	1993 U-3

1993 GU-3 SWIVEL HEAD REVERSIBLE RATCHET 1/2"

- > Especially for use in the automotive sector
- > Swivels through 180°, with joint lock
- > With non-slip metal disc change, fine-toothed (72 teeth) and robust
- > Return angle 5 degrees
- > Non-slip 2-component handle with hanging hole
- > Max. torque 300 N-m
- > For hand-operated sockets and accessories with square drive as per DIN 3120 - C 12.5, ISO 1174, ball locking device
- > GEDORE vanadium steel 31CrV3, chrome-plated

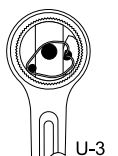

1/2"	mm	°	mm	mm	kg	Code	No.
1/2	12.5	5	282	40.5	0.535	6144320	1993 GU-3

1993 GU-10 XL SWIVEL HEAD REVERSIBLE RATCHET 1/2"

extra long

- > Extra long design
- > Ideal for the truck and/or industrial vehicle sectors
- > Swivels through 180°
- > With recessed lever change
- > Push-button release
- > Return angle 7.5 degrees
- > Non-slip 2-component handle with hanging hole
- > Especially suitable for high torques, max. torque 600 N-m
- > Locks in the middle position: When the lever is flipped, it automatically engages for clockwise or anti-clockwise operation
- > For hand-operated sockets and accessories with square drive as per DIN 3120 - C 12.5, ISO 1174, ball locking device
- > GEDORE vanadium steel 31CrV3, chrome-plated



"	mm	°	mm	kg	Code	No.
1/2	12.5	7,5	600	1.160	2018934	1993 GU-10 XL

1993 Z-94 RATCHET HANDLE WITH COUPLER 1/2"

- > Used throughout industry and the automotive world
- > Acc. to DIN 3122, ISO 3315
- > With square coupler, medium-fine toothed, extremely rugged
- > Return angle 7.5 degrees
- > Non-slip 2-component handle with hanging hole
- > For hand-operated sockets and accessories with square drive as per DIN 3120 - C 12.5, ISO 1174 ball locking device
- > GEDORE vanadium steel 31CrV3, chrome-plated

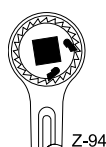

1993 U-10 K PLASTIC RATCHET 1/2"

- > For fast and easy tightening of bolted connections up to max. 70 N-m
- > Very handy and compact, housing and handle form one unit
- > Return angle 7.5 degrees
- > Made from sturdy compound material with a steel mechanism
- > Dimensions: 44 x 145 x 42.2 mm



"	mm	°	mm	mm	kg	Code	No.
1/2	12.5	7,5	270	21.9	0.476	6144590	1993 Z-94
1/2	12.5	7,5	145	42.2	0.226	6242760	1993 U-10 K SCHWARZ

Sockets 12.5 (1/2")

19
SOCKET 1/2"

hexagon UD profile

- > Acc. to DIN 3124, ISO 2725-1
- > Square drive as per DIN 3120 - C 12.5, ISO 1174, with ball retaining groove
- > Hand-operated, knurled grip
- > GEDORE vanadium steel 31CrV3, polished, chrome-plated
- * not standardised



Ø mm	L	d ₁	d ₂	t	⊖kg	Code	No.	
8	38.0	13.0	22.5	15.0	0.055	6130020	19 8	
9	*	38.0	14.2	22.5	15.0	0.056	6130100	19 9
10	38.0	15.5	22.5	13.5	0.056	6130290	19 10	
11	38.0	16.7	22.5	12.5	0.058	6130370	19 11	
12	38.0	18.0	22.5	12.5	0.058	6130450	19 12	
13	38.0	19.2	22.5	12.5	0.061	6130530	19 13	
14	38.0	20.5	22.5	12.5	0.063	6130610	19 14	
15	39.5	21.7	23.8	15.0	0.074	6130880	19 15	
16	39.5	22.5	23.8	15.0	0.075	6130960	19 16	
17	39.5	24.0	22.5	15.0	0.074	6131180	19 17	
18	39.5	25.5	23.0	17.0	0.073	6131260	19 18	
19	40.0	26.7	24.2	17.0	0.085	6131340	19 19	
20	40.0	28.0	25.5	17.0	0.096	6131420	19 20	
21	41.5	29.2	26.0	18.5	0.106	6131500	19 21	

Ø mm	L	d ₁	d ₂	t	⊖kg	Code	No.	
22	41.5	30.5	26.3	18.5	0.112	6131690	19 22	
23	*	41.5	31.7	27.5	18.5	0.122	6131770	19 23
24	41.5	33.0	28.0	18.5	0.132	6131850	19 24	
25	*	41.5	34.2	28.8	18.5	0.139	6131930	19 25
26	*	41.5	35.5	29.4	18.5	0.148	6132070	19 26
27	41.5	36.7	30.0	18.5	0.157	6132150	19 27	
28	*	43.0	38.0	30.5	20.0	0.168	6132230	19 28
29	*	43.0	39.2	31.2	20.0	0.181	6132310	19 29
30	43.0	40.5	32.5	20.5	0.193	6132580	19 30	
32	44.5	43.0	34.5	22.5	0.226	6132740	19 32	
33	*	44.5	44.2	36.0	22.5	0.226	2545306	19 33
34	44.5	45.5	37.0	22.5	0.259	6138270	19 34	
36	*	44.5	48.0	38.0	22.5	0.271	1718711	19 36

19 L
SOCKET 1/2"

hexagon UD profile, long pattern

- > Acc. to DIN 3124, ISO 2725-1
- > Square drive as per DIN 3120 - C 12.5, ISO 1174, with ball retaining groove
- > Hand-operated, knurled grip
- > GEDORE vanadium steel 31CrV3, polished, chrome-plated



Ø mm	L	d ₁	d ₂	t	⊖kg	Code	No.
10	77.0	15.5	22.5	12.0	0.117	1718738	19 L 10
11	77.0	16.7	22.5	13.0	0.121	1718746	19 L 11
12	77.0	18.0	22.5	14.0	0.127	1718754	19 L 12
13	77.0	19.2	22.5	16.0	0.098	1718762	19 L 13
14	77.0	20.5	22.5	16.5	0.109	1718770	19 L 14
15	77.0	21.7	22.5	16.5	0.117	1718789	19 L 15
16	77.0	23.0	24.0	16.5	0.130	1718800	19 L 16
17	77.0	24.0	24.0	16.5	0.132	1718819	19 L 17
18	82.0	25.5	25.0	20.0	0.147	1718827	19 L 18
19	82.0	26.7	26.0	22.0	0.174	1718835	19 L 19
21	82.0	29.2	28.5	24.0	0.211	2300559	19 L 21
22	82.0	30.5	28.5	24.0	0.219	2300567	19 L 22
24	82.0	33.0	29.0	26.0	0.257	2300575	19 L 24
27	82.0	36.7	30.0	30.0	0.290	2300583	19 L 27
30	82.0	40.5	32.5	33.0	0.351	2300591	19 L 30

Ø mm	L	d ₁	d ₂	t	⊖kg	Code	No.
32	82.0	43.0	34.5	36.0	0.387	2300605	19 L 32
34	82.0	45.5	36.5	37.0	0.432	2300613	19 L 34



D 19 (MM)

SOCKET 1/2"

bi-hexagon UD profile

- > Acc. to DIN 3124, ISO 2725-1
 - > Square drive as per DIN 3120 - C 12.5, ISO 1174, with ball retaining groove
 - > Hand-operated, knurled grip
 - > GEDORE vanadium steel 31CrV3, polished, chrome-plated
- * not standardised

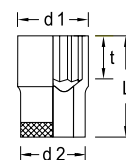

Ø mm	L	d ₁	d ₂	t	⚖	Code	No.
8	38.0	13.0	22.5	7.0	0.051	6133040	D 19 8
9	* 38.0	14.2	22.5	8.0	0.052	6133120	D 19 9
10	38.0	15.5	22.5	13.5	0.056	6133200	D 19 10
11	38.0	16.7	22.5	12.5	0.057	6133390	D 19 11
12	38.0	18.0	22.5	12.5	0.057	6133470	D 19 12
13	38.0	19.2	22.5	12.5	0.059	6133550	D 19 13
14	38.0	20.5	22.5	12.5	0.061	6133630	D 19 14
15	39.5	21.7	23.8	15.0	0.072	6133710	D 19 15
16	39.5	22.5	23.8	15.0	0.072	6133980	D 19 16
17	39.5	24.0	22.5	15.0	0.070	6134010	D 19 17
18	39.5	25.5	23.0	17.0	0.068	6134280	D 19 18
19	40.0	26.7	24.2	17.0	0.081	6134360	D 19 19
20	40.0	28.0	25.5	17.0	0.090	6134440	D 19 20
21	41.5	29.2	26.0	18.5	0.101	6134520	D 19 21

Ø mm	L	d ₁	d ₂	t	⚖	Code	No.
22	41.5	30.5	26.3	18.5	0.106	6134600	D 19 22
23	* 41.5	31.7	27.5	18.5	0.118	6134790	D 19 23
24	41.5	33.0	28.0	18.5	0.123	6134870	D 19 24
25	* 41.5	34.2	28.8	18.5	0.131	6134950	D 19 25
26	* 41.5	35.5	29.4	18.5	0.139	6135090	D 19 26
27	41.5	36.7	30.0	18.5	0.143	6135170	D 19 27
28	* 43.0	38.0	30.5	20.0	0.163	6135250	D 19 28
29	* 43.0	39.2	31.2	20.0	0.168	6135330	D 19 29
30	43.0	40.5	32.5	20.5	0.182	6135410	D 19 30
32	44.5	43.0	34.5	22.5	0.204	6135760	D 19 32
33	* 44.5	44.2	36.0	22.5	0.221	6135840	D 19 33
34	* 44.5	45.5	37.0	22.5	0.251	2545314	D 19 34
36	* 44.5	48.0	38.0	22.5	0.271	2194686	D 19 36

D 19 (AF)

SOCKET 1/2"

bi-hexagon UD profile

- > Square drive as per DIN 3120 - C 12.5, ISO 1174, with ball retaining groove
- > Hand-operated, knurled grip
- > GEDORE vanadium steel 31CrV3, polished, chrome-plated

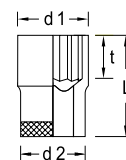

Ø AF	L	d ₁	d ₂	t	⚖	Code	No.
5/16	38.0	13.0	22.5	7.0	0.052	6136060	D 19 5/16AF
11/32	38.0	13.9	22.5	8.0	0.054	6136140	D 19 11/32AF
3/8	38.0	14.9	22.5	15.0	0.055	6136220	D 19 3/8AF
13/32	38.0	15.9	22.5	13.5	0.055	6136300	D 19 13/32AF
7/16	38.0	16.7	22.5	12.5	0.056	6136490	D 19 7/16AF
1/2	38.0	18.7	22.5	12.5	0.058	6136570	D 19 1/2AF
9/16	38.0	20.7	22.5	12.5	0.061	6136650	D 19 9/16AF
19/32	39.5	21.7	23.8	15.0	0.070	6136730	D 19 19/32AF
5/8	39.5	22.5	23.8	15.0	0.073	6136810	D 19 5/8AF
11/16	39.5	24.7	22.5	17.0	0.066	6137030	D 19 11/16AF
3/4	40.0	26.7	24.2	17.0	0.084	6137110	D 19 3/4AF
25/32	40.0	27.7	25.3	17.0	0.090	6137380	D 19 25/32AF
13/16	41.5	28.5	25.7	18.5	0.097	6137460	D 19 13/16AF
7/8	41.5	30.6	26.5	18.5	0.105	6137540	D 19 7/8AF
15/16	41.5	32.6	28.3	18.5	0.126	6137620	D 19 15/16AF

Ø AF	L	d ₁	d ₂	t	⚖	Code	No.
1	41.5	34.6	28.9	18.5	0.138	6137700	D 19 1AF
1.1/16	41.5	36.7	30.0	18.5	0.147	6137890	D 19 1.1/16AF
1.1/8	43.0	38.6	31.0	20.0	0.159	6137970	D 19 1.1/8AF
1.3/16	43.0	40.6	32.5	20.5	0.183	6138000	D 19 1.3/16AF
1.1/4	44.5	42.6	34.5	22.5	0.207	6138190	D 19 1.1/4AF

D 19 (WW) SOCKET 1/2"

bi-hexagon

- > Square drive as per DIN 3120 - C 12.5, ISO 1174, with ball retaining groove
- > Hand-operated, knurled grip
- > GEDORE vanadium steel 31CrV3, polished, chrome-plated

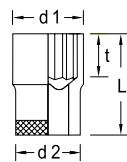

Whitw.	L	d ₁	d ₂	t	$\frac{m}{kg}$	Code	No.
3/16	38.0	17.0	22.5	12.5	0.054	6138780	D 19 3/16W
1/4	38.0	19.5	22.5	12.5	0.057	6138860	D 19 1/4W
5/16	39.5	21.9	23.8	15.0	0.069	6138940	D 19 5/16W
3/8	39.5	25.5	23.0	17.0	0.066	6139080	D 19 3/8W
7/16	41.5	28.8	26.0	18.5	0.096	6139160	D 19 7/16W
1/2	41.5	32.1	27.8	18.5	0.124	6139240	D 19 1/2W
9/16	41.5	34.9	29.2	18.5	0.137	6139320	D 19 9/16W
5/8	43.0	37.8	30.5	20.0	0.166	6139400	D 19 5/8W
11/16	43.0	41.0	33.0	20.5	0.184	6139590	D 19 11/16W
3/4	44.5	44.2	36.0	22.5	0.225	6138430	D 19 3/4W



D 19 L (MM) SOCKET 1/2"

bi-hexagon UD profile, long pattern

- > Acc. to DIN 3124, ISO 2725-1
- > Square drive as per DIN 3120 - C 12.5, ISO 1174, with ball retaining groove
- > Hand-operated, knurled grip
- > GEDORE vanadium steel 31CrV3, polished, chrome-plated
- > Sizes 16, 18, 21 mm with hole drilled for tommy bar Ø 8 mm

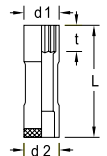

Ø mm	L	d ₁	d ₂	t	$\frac{m}{kg}$	Code	No.
10	77.0	15.5	22.5	12.0	0.117	6141140	D 19 L 10
12	77.0	18.0	22.5	14.0	0.127	6141220	D 19 L 12
13	77.0	19.2	22.5	16.0	0.101	6140170	D 19 L 13
14	77.0	20.5	22.5	16.5	0.109	6140250	D 19 L 14
15	77.0	21.7	22.5	16.5	0.119	6142460	D 19 L 15
16	77.0	23.0	24.0	16.5	0.128	6142540	D 19 L 16
17	77.0	24.0	24.0	16.5	0.133	6140330	D 19 L 17
18	82.0	25.5	25.0	20.0	0.147	6142380	D 19 L 18
19	82.0	26.7	26.0	22.0	0.175	6140410	D 19 L 19
21	82.0	29.2	28.5	24.0	0.211	6140680	D 19 L 21
22	82.0	30.5	28.5	24.0	0.219	6145050	D 19 L 22
24	82.0	33.0	29.0	26.0	0.257	6140760	D 19 L 24
27	82.0	36.7	30.0	30.0	0.290	6141060	D 19 L 27
30	82.0	40.5	32.5	33.0	0.351	6145640	D 19 L 30
32	82.0	43.0	34.5	36.0	0.387	6191320	D 19 L 32
34	82.0	45.5	36.5	37.0	0.432	6147500	D 19 L 34

D 19 L (AF) SOCKET 1/2"

bi-hexagon UD profile, long pattern

- > Square drive as per DIN 3120 - C 12.5, ISO 1174, with ball retaining groove
- > Hand-operated, knurled grip
- > GEDORE vanadium steel 31CrV3, polished, chrome-plated



D 19 L 19

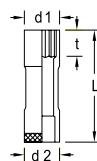

Ø AF	L	d ₁	d ₂	t	$\frac{m}{kg}$	Code	No.
1/2	77.0	18.7	22.5	16.0	0.095	6141300	D 19 L 1/2AF
9/16	77.0	20.7	22.5	16.5	0.105	6141490	D 19 L 9/16AF
5/8	77.0	22.5	24.0	16.5	0.120	6141570	D 19 L 5/8AF
11/16	77.0	24.7	24.8	16.5	0.143	6141650	D 19 L 11/16AF
3/4	82.0	26.7	26.0	22.0	0.164	6141730	D 19 L 3/4AF
13/16	82.0	28.5	28.5	22.0	0.197	6141810	D 19 L 13/16AF
7/8	82.0	30.6	28.5	24.0	0.208	6142030	D 19 L 7/8AF
15/16	82.0	32.6	29.0	26.0	0.234	6142110	D 19 L 15/16AF



TX 19 SOCKET 1/2"

for protruding TORX® head screws

- > Square drive as per DIN 3120 - C 12.5, ISO 1174, with ball retaining groove
- > Hand-operated, knurled grip
- > GEDORE vanadium steel 31CrV3, polished, chrome-plated
- > TORX® = reg. trademark of Acument Intellectual Properties, LLC. USA



TX 19 E10



TX 19 E18

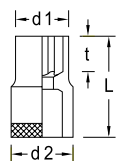

Ø	M	mm	L	d ₁	d ₂	t	$\frac{m}{kg}$	Code	No.
E10	M8	9,42	38.0	13.5	22.5	15.5	0.056	6145720	TX 19 E10
E11	-	10,08	38.0	14.0	22.5	15.5	0.055	6194180	TX 19 E11
E12	M10	11,17	38.0	15.5	22.5	15.5	0.059	6147340	TX 19 E12
E14	M12	12,90	38.0	17.0	22.5	13.0	0.059	6147420	TX 19 E14
E16	M12	14,76	38.0	19.0	22.5	13.0	0.062	6194420	TX 19 E16
E18	M14	16,70	40.0	21.0	24.5	14.0	0.078	6194500	TX 19 E18
E20	M16	18,45	40.0	23.5	24.5	14.0	0.085	6194690	TX 19 E20
E24	M18 - M20	22,16	41.5	28.5	26.0	16.0	0.116	6195070	TX 19 E24

ITX 19 SCREWDRIVER BIT SOCKET 1/2"

12.5
1/2"

for recessed TORX® head screws

- > Square drive as per DIN 3120 - C 12.5, ISO 1174, with ball retaining groove
- > Hand-operated, knurled grip
- > Chrome-plated
- > With pressed-in pin in GEDORE vanadium special steel, gun-metal finish
- > TORX® = reg. trademark of Acument Intellectual Properties, LLC. USA

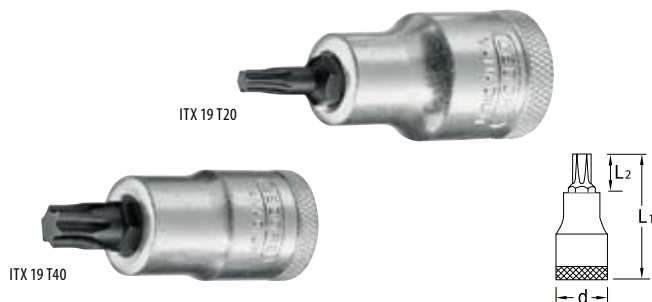

⊕	M	mm	L ₁	L ₂	d	kg	Code	No.
T20	M4 - M5	3,86	55	17	22.5	0.076	6152930	ITX 19 T20
T25	M4,5 - M5	4,43	55	17	22.5	0.075	6154200	ITX 19 T25
T27	M4,5 - M6	4,99	55	17	22.5	0.076	6154630	ITX 19 T27
T30	M6 - M7	5,52	55	17	22.5	0.075	6156170	ITX 19 T30
T40	M7 - M8	6,65	55	17	22.5	0.076	6156330	ITX 19 T40
T45	M8 - M10	7,82	55	17	22.5	0.077	6157060	ITX 19 T45
T50	M10	8,83	55	17	22.5	0.092	6158030	ITX 19 T50
T55	M12	11,22	55	17	23.0	0.107	6158380	ITX 19 T55
T60	M14	13,25	55	15	24.7	0.137	6158540	ITX 19 T60

ITX 19 L SCREWDRIVER BIT SOCKET 1/2"

12.5
1/2"

for recessed TORX® head screws, long pattern

- > Square drive as per DIN 3120 - C 12.5, ISO 1174, with ball retaining groove
- > Hand-operated, knurled grip
- > Chrome-plated
- > With pressed-in pin in GEDORE vanadium special steel, gun-metal finish
- > TORX® = reg. trademark of Acument Intellectual Properties, LLC. USA



⊕	M	mm	L ₁	L ₂	d	kg	Code	No.
T20	M4 - M5	3,86	100	62	22.5	0.095	6188020	ITX 19 L T20-100
T25	M4,5 - M5	4,43	100	62	22.5	0.095	6188100	ITX 19 L T25-100
T27	M4,5 - M6	4,99	100	62	22.5	0.096	6188370	ITX 19 L T27-100
T30	M6 - M7	5,52	100	62	22.5	0.096	6152500	ITX 19 L T30-100
T40	M7 - M8	6,65	100	62	22.5	0.096	6152690	ITX 19 L T40-100
T45	M8 - M10	7,82	100	62	22.5	0.098	6155870	ITX 19 L T45-100
T50	M10	8,83	100	62	22.5	0.124	6158700	ITX 19 L T50-100
T55	M12	11,22	100	62	23.0	0.151	6159940	ITX 19 L T55-100
T60	M14	13,25	100	60	24.7	0.197	6188450	ITX 19 L T60-100
T70	M16	15,55	100	60	28.0	0.277	6105180	ITX 19 L T70-100

ITX 19 B SCREWDRIVER BIT SOCKET 1/2"

12.5
1/2"

for recessed TORX® head screws with pilot

- > Square drive as per DIN 3120 - C 12.5, ISO 1174, with ball retaining groove
- > Hand-operated, knurled grip
- > Chrome-plated

- > With pressed-in pin in GEDORE vanadium special steel, gun-metal finish
- > TORX® = reg. trademark of Acument Intellectual Properties, LLC. USA



⊕	M	mm	L ₁	L ₂	d	Bore mm	kg	Code	No.
T20	M4 - M5	3,86	55	17	22.5	1,55 x 1,86	0.075	6192720	ITX 19 B T20
T25	M4,5 - M5	4,43	55	17	22.5	1,93 x 2,04	0.075	6195660	ITX 19 B T25
T27	M4,5 - M6	4,99	55	17	22.5	2,18 x 2,29	0.076	6196390	ITX 19 B T27
T30	M6 - M7	5,52	55	17	22.5	2,56 x 2,92	0.076	6200170	ITX 19 B T30
T40	M7 - M8	6,65	55	17	22.5	2,92 x 3,28	0.091	6200410	ITX 19 B T40
T45	M8 - M10	7,82	55	17	22.5	3,45 x 3,68	0.092	6200840	ITX 19 B T45
T50	M10	8,83	55	17	23.0	3,83 x 3,78	0.105	6201300	ITX 19 B T50
T55	M12	11,22	55	15	24.7	4,85 x 4,79	0.133	6202700	ITX 19 B T55
T60	M14	13,25	56	16	28.0	5,63 x 7,87	0.182	6203270	ITX 19 B T60

1500 CT1-ITX 19 LKP

> 109



IS 19

SCREWDRIVER BIT SOCKET

1/2"

12.5
1/2"

for slotted head screws

- > Square drive as per DIN 3120 - C 12.5, ISO 1174, with ball retaining groove
- > Hand-operated, knurled grip
- > Chrome-plated
- > With pressed-in pin in GEDORE vanadium special steel, manganese-phosphated
- > Blade as per DIN ISO 2380-1, Form B

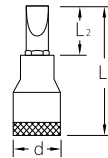

mm	mm	L ₁	L ₂	d	kg	Code	No.
6.5	1.2	60	22	22.5	0.071	6161760	IS 19 6,5x1,2
8.0	1.2	60	22	22.5	0.080	6656060	IS 19 8x1,2
10.0	1.6	60	22	22.5	0.115	6656140	IS 19 10x1,6
12.0	2.0	60	22	23.0	0.110	6656220	IS 19 12x2
14.0	2.5	60	20	24.7	0.138	6162140	IS 19 14x2,5
16.0	2.5	60	20	28.0	0.190	6656490	IS 19 16x2,5
18.0	2.5	60	20	27.0	0.193	6656570	IS 19 18x2,5

IKS 19

SCREWDRIVER BIT SOCKET

1/2"

12.5
1/2"

for cross-head screws PH

- > Square drive as per DIN 3120 - C 12.5, ISO 1174, with ball retaining groove
- > Hand-operated, knurled grip
- > Chrome-plated
- > With pressed-in pin in GEDORE vanadium special steel, gun-metal finish
- > Tip as per DIN ISO 8764-1 PH

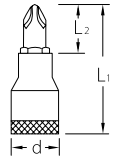

PH	L ₁	L ₂	d	kg	Code	No.
2	60	22	22.5	0.077	6656650	IKS 19 2
3	60	22	22.5	0.092	6656730	IKS 19 3
4	60	22	23.0	0.106	6656810	IKS 19 4

IKS 19 PZD

SCREWDRIVER BIT SOCKET

1/2"

12.5
1/2"

for cross-head screws Pozi PZ

- > Square drive as per DIN 3120 - C 12.5, ISO 1174, with ball retaining groove
- > Hand-operated, knurled grip
- > Chrome-plated
- > With pressed-in pin in GEDORE vanadium special steel, gun-metal finish
- > Tip as per DIN ISO 8764-1 PZ

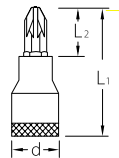

PZ	L ₁	L ₂	d	kg	Code	No.
2	60	22	22.5	0.077	6156680	IKS 19 PZD 2
3	60	22	22.5	0.091	6156760	IKS 19 PZD 3
4	60	22	23.0	0.108	6156840	IKS 19 PZD 4

IN 19 (MM)

SCREWDRIVER BIT SOCKET

1/2"

12.5
1/2"

for in-hex screws

- > Acc. to DIN 7422
- > Square drive as per DIN 3120 - C 12.5, ISO 1174, with ball retaining groove
- > Hand-operated, knurled grip
- > Chrome-plated
- > With pressed-in pin in GEDORE vanadium special steel, manganese-phosphated
- > IN 19 17 for oil filter and drain plug screws
- * not standardised

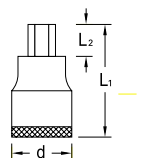

mm	L ₁	L ₂	d	kg	Code	No.
4	*	60	22	0.068	6153070	IN 19 4
5	*	60	22	0.069	6153150	IN 19 5
6		60	22	0.070	6153230	IN 19 6
7		60	22	0.075	6153310	IN 19 7
8		60	22	0.082	6153580	IN 19 8
9	*	60	22	0.091	6153660	IN 19 9
10		60	22	0.099	6153740	IN 19 10
12		60	22	0.113	6153820	IN 19 12
14		60	20	0.149	6153900	IN 19 14
17	*	60	20	0.210	6154040	IN 19 17
19	*	60	20	0.222	6154120	IN 19 19

VDE IN 19

>574



IN 19 L SCREWDRIVER BIT SOCKET 1/2"

12.5
1/2"

for in-hex screws, long pattern

- > Acc. to DIN 7422
- > Square drive as per DIN 3120 - C 12.5, ISO 1174, with ball retaining groove
- > Hand-operated, knurled grip
- > Chrome-plated

- > With pressed-in pin in GEDORE vanadium special steel, manganese-phosphated
- * t = stepped hexagon bit 13 mm
- * not standardised

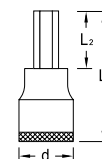

mm	L ₁	L ₂	d	* t	mm	Code	No.	
5	*	90	52	22.5	13	0.091	6162060	IN 19 L 5-90
5	*	180	142	22.5	13	0.131	6157140	IN 19 L 5-180
6		90	52	22.5		0.079	6157300	IN 19 L 6-90
6		140	102	22.5	13	0.115	6145800	IN 19 L 6-140
6		160	122	22.5	13	0.123	6145990	IN 19 L 6-160
7		100	62	22.5		0.089	6157570	IN 19 L 7-100
7	*	140	102	22.5			2950960	IN 19 L 7-140
8		90	52	22.5		0.095	6157730	IN 19 L 8-90

mm	L ₁	L ₂	d	* t	mm	Code	No.
8		120	82	22.5	0.109	6157810	IN 19 L 8-120
8	*	140	102	22.5		2951533	IN 19 L 8-140
9	*	140	102	22.5		2950979	IN 19 L 9-140
10		140	102	22.5	0.154	6158110	IN 19 L 10-140
12		140	102	23.0	0.195	6158460	IN 19 L 12-140
14		140	100	24.7	0.257	6158620	IN 19 L 14-140

IN 19 (AF) SCREWDRIVER BIT SOCKET 1/2"

12.5
1/2"

for in-hex screws

- > Square drive as per DIN 3120 - C 12.5, ISO 1174, with ball retaining groove
- > Hand-operated, knurled grip
- > Chrome-plated
- > With pressed-in pin in GEDORE vanadium special steel, manganese-phosphated

IN 19 K SCREWDRIVER BIT SOCKET 1/2"

12.5
1/2"

with ball end, for in-hex screws

- > Square drive as per DIN 3120 - C 12.5, ISO 1174, with ball retaining groove
- > Hand-operated, knurled grip
- > Chrome-plated
- > With pressed-in pin in GEDORE vanadium special steel, gun-metal finish
- > Total swivel angle approx. 15-20°



IN 19 1/2

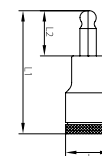
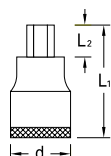

mm AF	L ₁	L ₂	d	mm	Code	No.
3/16	60	22	22.5	0.069	6154710	IN 19 3/16AF
7/32	60	22	22.5	0.069	6154980	IN 19 7/32AF
1/4	60	22	22.5	0.073	6155010	IN 19 1/4AF
9/32	60	22	22.5	0.076	6155280	IN 19 9/32AF
5/16	60	22	22.5	0.081	6155360	IN 19 5/16AF
3/8	60	22	22.5	0.098	6155440	IN 19 3/8AF
1/2	60	22	23.0	0.119	6155520	IN 19 1/2AF
9/16	60	20	24.7	0.150	6155600	IN 19 9/16AF
5/8	60	20	28.0	0.205	6155790	IN 19 5/8AF

mm	L ₁	L ₂	d	mm	Code	No.
6	60	22	22.5	0.068	2219336	IN 19 K 6
7	60	22	22.5	0.071	2219360	IN 19 K 7
8	60	22	22.5	0.080	2219379	IN 19 K 8
10	60	22	22.5	0.100	2219395	IN 19 K 10
12	60	20	23.0	0.190	1621513	IN 19 K 12
14	60	20	24.7	0.220	2663090	IN 19 K 14

IN 19 LK SCREWDRIVER BIT SOCKET 1/2"

12.5
1/2"

with ball end, for in-hex screws, long pattern

- > Square drive as per DIN 3120 - C 12.5, ISO 1174, with ball retaining groove
- > Hand-operated, knurled grip
- > Chrome-plated
- > With pressed-in pin in GEDORE vanadium special steel, gun-metal finish
- > Total swivel angle approx. 15-20°

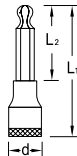

mm	L ₁	L ₂	d	kg	Code	No.
6	140	102	22.5	0.091	6162810	IN 19 LK 6-140
7	140	102	22.5	0.103	6165080	IN 19 LK 7-140
8	140	102	22.5	0.116	6165160	IN 19 LK 8-140
10	140	102	22.5	0.153	6166800	IN 19 LK 10-140
12	140	102	23.0	0.195	6172370	IN 19 LK 12-140
14	140	100	24.7	0.225	1936328	IN 19 LK 14-140

INR 19 L SCREWDRIVER BIT SOCKET 1/2"

12.5
1/2"

for multi-spline screws RIBE®, long pattern

- > RIBE® = reg. trademark of Richard Bergner GmbH & Co. KG, Schwabach, Germany



INR 19 L 5-100



INR 19 L 14-100

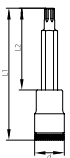

M	L ₁	L ₂	d	kg	Code	No.
M5	100	62	22.5	0.085	1449826	INR 19 L 5-100
M6	100	62	22.5	0.085	1449850	INR 19 L 6-100
M6	188	150	22.5	0.120	1450859	INR 19 L 6-188
M8	100	62	22.5	0.085	1449877	INR 19 L 8-100
M8	188	150	22.5	0.125	1450875	INR 19 L 8-188
M10	100	62	22.5	0.105	1449591	INR 19 L 10-100
M10	188	150	22.5	0.165	1450891	INR 19 L 10-188
M12	100	62	22.5	0.145	1398636	INR 19 L 12-100
M12	188	150	22.5	0.230	1450913	INR 19 L 12-188
M14	100	60	24.7	0.155	1449893	INR 19 L 14-100

INX 19 SCREWDRIVER BIT SOCKET 1/2"

12.5
1/2"

for multi-point screws XZN

- > Acc. to DIN 2324
- > Square drive as per DIN 3120 - C 12.5, ISO 1174, with ball retaining groove
- > Hand-operated, knurled grip
- > Chrome-plated
- > With pressed-in pin in GEDORE vanadium special steel, manganese-phosphated
- > Tip as per DIN 2325
- * not standardised

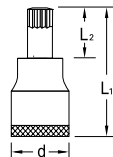

M	L ₁	L ₂	d	kg	Code	No.	
M5	*	55	17	22.5	0.075	6158890	INX 19 5
M6	*	55	17	22.5	0.076	6159000	INX 19 6
M8		55	17	22.5	0.077	6159270	INX 19 8
M10		55	17	22.5	0.094	6159430	INX 19 10
M12		55	17	23.0	0.110	6159780	INX 19 12
M14		57	17	24.7	0.140	1888943	INX 19 14
M16	*	60	20	24.7		2950944	INX 19 16
M18	*	60	20	24.7		2950952	INX 19 18

INX 19 L SCREWDRIVER BIT SOCKET 1/2"

12.5
1/2"

for multi-point screws XZN, long pattern

- > Acc. to DIN 2324
- > Square drive as per DIN 3120 - C 12.5, ISO 1174, with ball retaining groove
- > Hand-operated, knurled grip
- > Chrome-plated
- > With pressed-in pin in GEDORE vanadium special steel, manganese-phosphated
- > Tip as per DIN 2325
- * not standardised

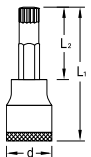

M	L ₁	L ₂	d	kg	Code	No.	
M6	*	100	62	22.5	0.093	6159190	INX 19 L 6-100
M8		100	62	22.5	0.097	6159350	INX 19 L 8-100
M10		100	62	22.5	0.124	6159510	INX 19 L 10-100
M12		100	62	23.0	0.149	6159860	INX 19 L 12-100
M14		100	60	24.7	0.110	1888951	INX 19 L 14-100

Accessories 12.5 (1/2")

1985 SPEED BRACE 1/2"

- > Acc. to DIN 3122, ISO 3315
- > For hand-operated sockets with square drive as per DIN 3120, ISO 1174, with ball locking device
- > GEDORE vanadium steel 31CrV3, polished, chrome-plated



"	mm	mm	kg	Code	No.
1/2	12.5	395	0.619	6143350	1985

1998 SWIVEL HANDLE WITH SLIDING T 1/2"

- > For hand-operated sockets with square drive as per DIN 3120, ISO 1174, with ball locking device
- > GEDORE vanadium steel 31CrV3, chrome-plated, polished



"	mm	mm	kg	Code	No.
1/2	12.5	460	0.747	6199730	1998

1996 - 1997 SWIVEL HANDLE 1/2"

- > Acc. to DIN 3122, ISO 3315
- > Non-slip 2-component handle with hanging hole
- > For hand-operated sockets with square drive as per DIN 3120, ISO 1174, with ball locking device
- > GEDORE vanadium steel 31CrV3, chrome-plated, polished



1996



1997

"	mm	mm	kg	Code	No.
1/2	12.5	255	0.426	6144830	1996

"	mm	mm	kg	Code	No.
1/2	12.5	381	0.593	6144910	1997

1987 SLIDING T BAR 1/2"

- > Acc. to DIN 3122, ISO 3315
- > For hand-operated sockets with square drive as per DIN 3120, ISO 1174, with ball locking device
- > GEDORE vanadium steel 31CrV3, polished, chrome-plated



"	mm	mm	kg	Code	No.
1/2	12.5	292	0.386	6143430	1987

1981 K L-HANDLE 1/2"

- > Acc. to DIN 3122, ISO 3315
- > For hand-operated sockets with square drive as per DIN 3120, ISO 1174, with ball locking device
- > GEDORE vanadium steel 31CrV3, polished, chrome-plated



"	mm	mm	kg	Code	No.
1/2	12.5	220	0.267	6143270	1981 K

1987 A SLIDING T BAR WITH RELEASE 1/2"

- > Secured against unintentional removal
- > GEDORE vanadium steel 31CrV3, polished, chrome-plated
- > Turn handle for easy locking and releasing
- > Accidental release when working is prevented because of the asymmetrical release point
- > Particularly useful for work in sensitive areas where certainty against loss is a theme
- > Examples: Aircraft engine, work in deep machine bodies
- > DBGM (German utility patent)



1/2"	12.5	↳ mm ▷	⚖️	Code	No.
1/2	12.5	292	0.375	1871641	1987 A

1990 EXTENSION 1/2"

- > Acc. to DIN 3123, ISO 3316
- > For hand-operated sockets with square drive as per DIN 3120, ISO 1174, with ball locking device
- > GEDORE vanadium steel 31CrV3, chrome-plated
- * not standardised



1990-2.1/2



1990-3



1990-5



1990-7



1990-10

1/2"	12.5	*	↳ mm ▷	⚖️	Code	No.
1/2	12.5	*	63	0.115	6143510	1990-2.1/2
1/2	12.5		76	0.137	6143780	1990-3
1/2	12.5		125	0.188	6143860	1990-5

1/2"	12.5	*	↳ mm ▷	⚖️	Code	No.
1/2	12.5	*	180	0.264	6142890	1990-7
1/2	12.5		250	0.361	6143940	1990-10
1/2	12.5	*	305	0.411	6129950	1990-12

1990 A EXTENSION 1/2"

with release

- > Easy access to deep-fitting screws
- > Locking ring prevents unintentional release of the socket
- > For hand-operated sockets with square drive as per DIN 3120, ISO 1174, with ball locking device



1990 A-5



1990 A-10



1/2"	12.5	↳ mm ▷	⚖️	Code	No.
1/2	12.5	125	0.216	1640828	1990 A-5

1/2"	12.5	↳ mm ▷	⚖️	Code	No.
1/2	12.5	250	0.386	1640801	1990 A-10

1990 KR UNIVERSAL EXTENSION 1/2"

- > With ball end
- > For hand-operated sockets with square drive as per DIN 3120, ISO 1174, with ball locking device
- > The extension is able to pivot up to 15°
- > Load capacity max. 230 N-m
- > GEDORE vanadium steel 31CrV3, polished, chrome-plated



1990 KR-5



1990 KR-7



1990 KR-10

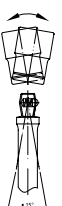

1/2"	12.5	↳ mm ▷	⚖️	Code	No.
1/2	12.5	125	0.180	6173180	1990 KR-5
1/2	12.5	180	0.255	6225590	1990 KR-7

1/2"	12.5	↳ mm ▷	⚖️	Code	No.
1/2	12.5	250	0.345	6366570	1990 KR-10

1990 M EXTENSION 1/2"

with magnet

- > For hand-operated sockets with square drive as per DIN 3120, ISO 1174, with ball locking device
- > The holding magnet securely fixes the screws or nuts in the socket
- > One-hand operation - using the socket the screw or nut can be immediately screwed in
- > Thanks to a spring mechanism the holding magnet is always in direct contact with the screw head. It ensures that the screw is centrally guided
- > A strong permanent magnet keeps hold of even large screws
- > Makes work easier particularly in confined spaces
- > Hot forged
- > GEDORE vanadium steel 31CrV3, polished



EISEN 2014
INNOVATION-AWARD



"	"	mm	kg	Code	No.
1/2	12.5	81.5	0.110	2697920	1990 M

1995 UNIVERSAL JOINT 1/2"

- > Acc. to DIN 3123, ISO 3316
- > For hand-operated sockets with square drive as per DIN 3120, ISO 1174, with ball locking device
- > GEDORE vanadium steel 31CrV3, chrome-plated, polished



"	"	"	"	mm	kg	Code	No.
1/2	12.5	1/2	12.5	72	0.159	6144750	1995

1930 REDUCER 1/2" TO 3/8"

- > Acc. to DIN 3123, ISO 3316
- > For hand-operated sockets with square drive as per DIN 3120, ISO 1174, with ball locking device
- > GEDORE vanadium steel 31CrV3, polished, chrome-plated



"	"	"	"	mm	kg	Code	No.
1/2	12.5	3/8	10	38.5	0.062	6143000	1930

1994 COUPLER 1/2"

- > Acc. to DIN 3122, ISO 3315
- > For hand-operated sockets with square drive as per DIN 3120, ISO 1174, with ball locking device
- > GEDORE vanadium steel 31CrV3, chrome-plated, polished



"	"	mm	kg	Code	No.
1/2	12.5	38	0.045	6144670	1994

1932 CONVERTOR 1/2" TO 3/4"

- > Acc. to DIN 3123, ISO 3316
- > For hand-operated sockets with square drive as per DIN 3120, ISO 1174, with ball locking device
- > GEDORE vanadium steel 31CrV3, polished, chrome-plated



"	"	"	"	mm	kg	Code	No.
1/2	12.5	3/4	20	44	0.128	6143190	1932

1940 HIGH-SPEED SWIVEL DISC

for 1/2" ratchets

- > For 12.5 mm (1/2") ratchets
- > Tightens loose screws with a flick of the wrist
- > Easy assembly between release head and socket
- > Speeds up the screwing process

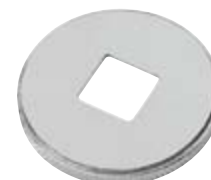

"	"	kg	Code	No.
1/2	12.5	0.014	1640887	1940



1990 M UNIVERSAL EXTENSION WITH MAGNETIC EFFECT



Your advantage:

- > Secure fixing even of large screws
- > One-handed operation Using the socket, the screw can be immediately screwed in
- > Powerful magnet with spring mechanism ensures centric screw guidance.
- > Makes work easier particularly in confined spaces

> The essentially plain-looking universal extension in combination, for instance, with the right sockets and socket drivers is transformed into our secret star.

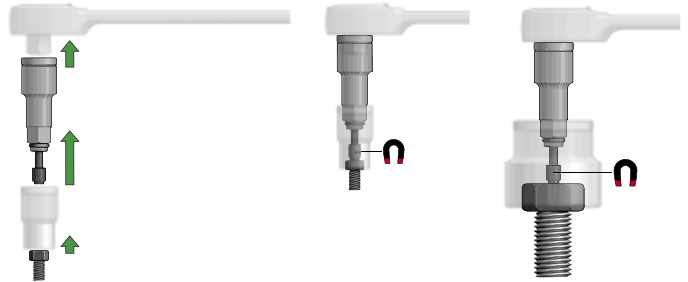

SL 19 TOOL HOLDING RAIL, MAGNETIC 1/2"

empty

- > External squares to take 12 or 16 standard commercial 12.5 mm (1/2") sockets
- > Two female square adaptors to take ratchets, sliding T bars, extensions etc.
- > A strong magnet securely holds the socket rail to ferrous metals
- > Additional holes are provided for wall mounting the socket rail or attaching to non-ferrous materials
- > The sockets are securely locked by the ball at the square-drive end by turning them 90°

- > It is a simple matter to "unlock" and remove the sockets, by turning them 90° in the opposing direction
- > Delivery without tools



Execution	↳ mm	mm	kg	Code	No.
for 12 pieces 1/2" sockets	480	33	0.481	1828665	SL 1912
for 16 pieces 1/2" sockets	580	33	0.522	1761102	SL 1916

VH 19 SPRING STEEL SOCKET RAIL 1/2"



- > For 14 1/2" sockets
- > Delivery without tools



↳ mm	kg	Code	No.
405	0.065	5162520	VH 19

VDE 1990

>574



VDE 1988 / VDE 1989 T

>574



20 (3/4") square drive

20 20

Sets 20 (3/4") METRIC

20 3/4

32 EM / D 32 EM
SOCKET SET 3/4"

14 pieces

- > With forged, tempered hexagon (no.32) or UD profile sockets (no. D 32), hand-operated
- > With accessories made from GEDORE vanadium steel 31CrV3
- > Set U-2 with fine toothed, dial change ratchet
- > Set Z-94 with ratchet with square coupler
- > In GEDORE blue sheet steel case
- > Dimensions: 525 x 203 x 73 mm

20
3/4
mm

Ratchet	Sockets	Accessories	mm	Code	No.
⊙ Z-94 3293 Z-94	⊙ 32 22 24 27 30 32 36 38 41 46 50	↔ 3287 ↔ 3290-8 -16	11.4	6280180	32 EMZ
⊙ U-2 3293 U-2	⊙ 32 22 24 27 30 32 36 38 41 46 50	↔ 3287 ↔ 3290-8 -16	11.6	6280340	32 EMU-2
⊙ Z-94 3293 Z-94	⊙ D 32 22 24 27 30 32 36 38 41 46 50	↔ 3287 ↔ 3290-8 -16	11.2	6280260	D 32 EMZ
⊙ U-2 3293 U-2	⊙ D 32 22 24 27 30 32 36 38 41 46 50	↔ 3287 ↔ 3290-8 -16	11.1	6280420	D 32 EMU-2

32 FM / D 32 FM
SOCKET SET 3/4"

16 pieces

- > With forged, tempered hexagon, bi-hexagon (no.32) or UD profile sockets (no. D 32), hand-operated
- > With accessories made from GEDORE vanadium steel 31CrV3
- > Set U-2 with fine toothed, dial change ratchet
- > Set Z-94 with ratchet with square coupler
- > In GEDORE blue sheet steel case
- > Dimensions: 555 x 230 x 80 mm

20
3/4
mm

Ratchet	Sockets	Accessories	mm	Code	No.
⊙ Z-94 3293 Z-94	⊙ 32 22 24 27 30 32 36 38 41 46 50 55 60	↔ 3287 ↔ 3290-8 -16	15.6	6280930	32 FMZ
⊙ U-2 3293 U-2	⊙ 32 22 24 27 30 32 36 38 41 46 50 55 60	↔ 3287 ↔ 3290-8 -16	15.8	6281150	32 FMU-2
⊙ Z-94 3293 Z-94	⊙ D 32 22 24 27 30 32 36 38 41 46 50 55 60	↔ 3287 ↔ 3290-8 -16	15.1	6281070	D 32 FMZ
⊙ U-2 3293 U-2	⊙ D 32 22 24 27 30 32 36 38 41 46 50 55 60	↔ 3287 ↔ 3290-8 -16	15.2	6281230	D 32 FMU-2

Sets 20 (3/4") INCH

D 32 EA SOCKET SET 3/4"

14 pieces

- > With forged, tempered bi-hexagon UD profile sockets, hand-operated
- > With accessories made from GEDORE vanadium steel 31CrV3
- > Set U-2 with fine toothed, dial change ratchet
- > Set Z-94 with ratchet with square coupler
- > In GEDORE blue sheet steel case
- > Dimensions: 525 x 203 x 73 mm



Ratchet	Sockets	Accessories		Code	No.
Z-94 3293 Z-94	D 32 15/16 1.1/16 1.1/8 1.1/4 1.5/16 1.3/8 1.1/2 1.5/8 1.7/8 2"	3287 3290-8 -16	11.3	6280500	D 32 EAZ
U-2 3293 U-2	D 32 15/16 1.1/16 1.1/8 1.1/4 1.5/16 1.3/8 1.1/2 1.5/8 1.7/8 2"	3287 3290-8 -16	11.3	6280690	D 32 EAU-2

D 32 EMAU-2 SOCKET SET 3/4"

25 pieces

- > With forged, tempered bi-hexagon UD profile sockets, hand-operated
- > With accessories made from GEDORE vanadium steel 31CrV3
- > With fine toothed, dial change ratchet
- > In GEDORE blue sheet steel case
- > Dimensions: 660 x 230 x 80 mm

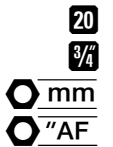

Ratchet	Sockets	Accessories		Code	No.
U-2 3293 U-2	D 32 22 24 27 30 32 36 41 46 50 D 32 7/8 15/16 1" 1.1/16 1.1/8 1.1/4 1.5/16 1.3/8 1.1/2 1.11/16 1.7/8 2"	3287 3290-8 -16	18.2	6281310	D 32 EMAU-2

... CUSTOMISED FOR YOU!

Individual – precise – customised – flexible – right on!

- > From non-standard sizes, special surface treatment (colour and/or finish), customised tool modules through to special electronic product programming and establishing/implementing individual maintenance intervals (calibration/services) - and a lot more besides.

- > **WE** develop special tools, customised tools and/or quality forgings **for YOU**.
- > Your problems are our assignments.
- > Simply contact us !



Ratchets 20 (3/4")

3293 U-10 REVERSIBLE RATCHET 3/4"

- › Particularly for the demanding use experienced in industry and with utility vehicles
- › Acc. to DIN 3122, ISO 3315
- › With recessed lever change, locks in middle position
- › Return angle 11.25 degrees

- › Push-fit tube handle
- › For hand-operated sockets and accessories with square drive as per DIN 3120 - D 20, ISO 1174 with locking pin
- › GEDORE vanadium steel 31CrV3, chrome-plated



"	mm	°	mm	mm	kg	Code	No.
3/4	20	11,25	620	57.5	2.630	6277980	3293 U-10

3293 U-2 REVERSIBLE RATCHET 3/4"

- › Especially for working in confined spaces
- › Acc. to DIN 3122, ISO 3315
- › With disc change, fine-toothed and robust
- › Return angle 7.2 degrees

- › For hand-operated sockets and accessories with square drive as per DIN 3120 - D 20, ISO 1174 with locking pin
- › GEDORE vanadium steel 31CrV3, chrome-plated

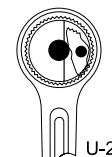

"	mm	°	mm	mm	kg	Code	No.
3/4	20	7,2	510	60	1.435	6278600	3293 U-2

3293 U-3 REVERSIBLE RATCHET 3/4"

- › Especially for working in confined spaces, as in the automotive business and with utility vehicles
- › Acc. to DIN 3122, ISO 3315
- › With non-slip metal disc change, fine-toothed (72 teeth) and robust
- › Return angle 5 degrees
- › Push-fit tube handle

- › For hand-operated sockets and accessories with square drive as per DIN 3120 - D 20, ISO 1174, with locking pin
- › GEDORE vanadium steel 31CrV3, chrome-plated

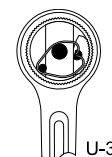

"	mm	°	mm	mm	kg	Code	No.
3/4	20	5	620	62.5	2.610	6278790	3293 U-3

3293 Z-94 RATCHET HANDLE WITH COUPLER 3/4"

- › Used throughout industry and the automotive world
- › Acc. to DIN 3122, ISO 3315
- › With square coupler, medium-fine toothed, extremely rugged
- › Return angle 10 degrees

- › For hand-operated sockets and accessories with square drive as per DIN 3120 - D 20, ISO 1174 with locking pin
- › GEDORE vanadium steel 31CrV3, chrome-plated



"	mm	°	mm	mm	kg	Code	No.
3/4	20	10	510	31	1.301	6278950	3293 Z-94

Sockets 20 (3/4")

32 SOCKET 3/4"

hexagon UD profile

- > Acc. to DIN 3124, ISO 2725-1
- > Square drive as per DIN 3120 - D 20, ISO 1174, with locking pin
- > Hand-operated, knurled grip
- > GEDORE vanadium steel 31CrV3, chrome-plated
- * not standardised

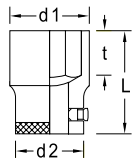

Ø mm	L	d ₁	d ₂	t	⚖️	Code	No.	
18	*	51.5	28.3	36.0	19.0	0.219	6269880	32 18
19	*	51.5	29.6	36.0	19.0	0.225	6270110	32 19
21		51.5	32.0	36.0	19.0	0.228	6269960	32 21
22		51.5	33.3	36.0	19.0	0.232	6270380	32 22
24		51.5	35.8	38.0	19.5	0.267	6270460	32 24
27		54.5	39.6	36.0	24.0	0.271	6270540	32 27
29	*	54.5	42.0	36.0	23.5	0.281	6270620	32 29
30		57.5	43.3	38.0	26.0	0.331	6270700	32 30
32		57.5	45.8	38.0	27.0	0.345	6270890	32 32
33	*	57.5	47.0	40.0	26.5	0.392	6270030	32 33
34		57.5	48.3	40.0	26.5	0.404	6279410	32 34

Ø mm	L	d ₁	d ₂	t	⚖️	Code	No.	
36		59.5	50.8	40.0	28.0	0.448	6270970	32 36
38	*	59.5	53.3	40.5	28.0	0.476	6271000	32 38
41		62.5	57.1	44.0	30.5	0.593	6271190	32 41
46		65.5	63.3	44.0	32.5	0.700	6271270	32 46
50		68.5	68.3	48.0	34.5	0.848	6271350	32 50
55		68.5	74.6	53.0	33.0	1.008	6271430	32 55
60		68.5	80.8	53.0	33.0	1.143	6271510	32 60

D 32 (MM) SOCKET 3/4"

bi-hexagon UD profile

- > Acc. to DIN 3124, ISO 2725-1
- > Square drive as per DIN 3120 - D 20, ISO 1174, with locking pin
- > Hand-operated, knurled grip
- > GEDORE vanadium steel 31CrV3, chrome-plated
- * not standardised

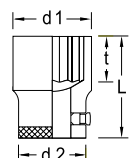

Ø mm	L	d ₁	d ₂	t	⚖️	Code	No.	
19	*	51.5	29.6	36.0	19.0	0.221	6272160	D 32 19
21		51.5	32.0	36.0	19.0	0.223	6289800	D 32 21
22		51.5	33.3	36.0	19.0	0.227	6272240	D 32 22
24		51.5	35.8	38.0	19.5	0.257	6272320	D 32 24
27		54.5	39.6	36.0	24.0	0.255	6272400	D 32 27
29	*	54.5	42.0	36.0	23.5	0.272	6272590	D 32 29
30		57.5	43.3	38.0	26.0	0.319	6272670	D 32 30
32		57.5	45.8	38.0	27.0	0.332	6272750	D 32 32
33	*	57.5	47.0	40.0	26.5	0.358	6277040	D 32 33
36		59.5	50.8	40.0	28.0	0.418	6272830	D 32 36

Ø mm	L	d ₁	d ₂	t	⚖️	Code	No.	
38	*	59.5	53.3	40.5	28.0	0.441	6272910	D 32 38
41		62.5	57.1	44.0	30.5	0.558	6273050	D 32 41
46		65.5	63.3	44.0	32.5	0.641	6273130	D 32 46
50		68.5	68.3	48.0	34.5	0.800	6273210	D 32 50
55		68.5	74.6	53.0	33.0	0.961	6273480	D 32 55
60		68.5	80.8	53.0	33.0	1.052	6273560	D 32 60

D 32 (AF) SOCKET 3/4"

bi-hexagon UD profile

- > Square drive as per DIN 3120 - D 20, ISO 1174, with locking pin
- > Hand-operated, knurled grip
- > GEDORE vanadium steel 31CrV3, chrome-plated

AF	L	d ₁	d ₂	t	kg	Code	No.
7/8	51.5	33.6	36.0	19.0	0.227	6274020	D 32 7/8AF
15/16	51.5	35.6	38.0	19.5	0.262	6274100	D 32 15/16AF
1	51.5	37.6	36.0	22.0	0.229	6274290	D 32 1AF
1.1/16	54.5	39.6	36.0	24.0	0.256	6274370	D 32 1.1/16AF
1.1/8	54.5	41.5	36.0	24.0	0.268	6274450	D 32 1.1/8AF
1.1/4	57.5	45.5	38.0	27.0	0.333	6274530	D 32 1.1/4AF
1.5/16	57.5	47.5	40.0	26.5	0.377	6274610	D 32 1.5/16AF
1.3/8	59.5	49.5	40.0	28.0	0.407	6274880	D 32 1.3/8AF



AF	L	d ₁	d ₂	t	kg	Code	No.
1.7/16	59.5	51.4	40.0	28.0	0.413	6274960	D 32 1.7/16AF
1.1/2	59.5	53.3	40.5	28.0	0.431	6275180	D 32 1.1/2AF
1.5/8	62.5	57.4	44.0	30.5	0.539	6275260	D 32 1.5/8AF
1.11/16	62.5	59.4	44.0	30.5	0.568	6275340	D 32 1.11/16AF
1.3/4	65.5	61.4	44.0	32.5	0.627	6275420	D 32 1.3/4AF
1.13/16	65.5	63.3	44.0	32.5	0.637	6275500	D 32 1.13/16AF
1.7/8	65.5	65.3	44.0	32.5	0.664	6275690	D 32 1.7/8AF
2	68.5	69.2	48.0	34.5	0.811	6275770	D 32 2AF

IN 32 SCREWDRIVER BIT SOCKET 3/4"

for in-hex screws

- > Acc. to DIN 7422
- > Square drive as per DIN 3120 - D 20, ISO 1174, with locking pin
- > Hand-operated, knurled grip
- > Chrome-plated
- > With pressed-in pin in GEDORE vanadium special steel, manganese-phosphated



mm	L ₁	L ₂	d	kg	Code	No.
14	80	25.5	38	0.352	6275850	IN 32 14
17	80	25.5	38	0.394	6275930	IN 32 17

mm	L ₁	L ₂	d	kg	Code	No.
19	80	25.5	38	0.433	6276070	IN 32 19
22	80	25.5	38	0.482	6276150	IN 32 22

IN 32 L SCREWDRIVER BIT SOCKET 3/4"

for in-hex screws, long pattern

- > Acc. to DIN 7422
- > Square drive as per DIN 3120 - D 20, ISO 1174, with locking pin
- > Hand-operated, knurled grip
- > Chrome-plated
- > With pressed-in pin in GEDORE vanadium special steel, manganese-phosphated



mm	L ₁	L ₂	d	kg	Code	No.
14	155	100	38	0.452	2003503	IN 32 L 14-155
17	155	100	38	0.540	1353705	IN 32 L 17-155
19	155	100	38	0.610	2003511	IN 32 L 19-155
22	155	100	38	0.730	2003538	IN 32 L 22-155

ITX 32 SCREWDRIVER BIT SOCKET 3/4"

for recessed TORX® head screws

- > Square drive as per DIN 3120 - D 20, ISO 1174, with locking pin
- > Hand-operated, knurled grip
- > Chrome-plated
- > With pressed-in pin in GEDORE vanadium special steel, gun-metal finish
- > TORX® = reg. trademark of Acument Intellectual Properties, LLC. USA



	M	mm	L ₁	L ₂	d	kg	Code	No.
T60	M14	13,25	80	25.5	38	0.346	6271780	ITX 32 T60
T70	M16	15,55	80	25.5	38	0.383	6272080	ITX 32 T70
T80	M18	17,58	80	25.5	38	0.416	6273640	ITX 32 T80
T90	M20	19,95	80	25.5	38	0.455	6276230	ITX 32 T90
T100	M22	21,16	80	25.5	38	0.461	6276310	ITX 32 T100

Accessories 20 (3/4")

3296 SWIVEL HANDLE 3/4"

- > Acc. to DIN 3122, ISO 3315
- > For hand-operated sockets with square drive as per DIN 3120, ISO 1174, with locking pin
- > GEDORE vanadium steel 31CrV3, chrome-plated



■ "	■	↳ mm ↳	⚖ kg	Code	No.
3/4	20	547	1.965	6279250	3296

3287 SLIDING T BAR 3/4"

- > Acc. to DIN 3122, ISO 3315
- > For hand-operated sockets with square drive as per DIN 3120, ISO 1174, with locking pin
- > GEDORE vanadium steel 31CrV3, chrome-plated



■ "	■	↳ mm ↳	⚖ kg	Code	No.
3/4	20	500	1.161	6278360	3287

3290 EXTENSION 3/4"

- > Acc. to DIN 3123, ISO 3316
- > For hand-operated sockets with square drive as per DIN 3120, ISO 1174, with locking pin
- > GEDORE vanadium steel 31CrV3, chrome-plated



3290-8



3290-16

■ "	■	↳ mm ↳	⚖ kg	Code	No.	■ "	■	↳ mm ↳	⚖ kg	Code	No.
3/4	20	200	0.574	6278440	3290-8	3/4	20	400	1.079	6278520	3290-16

3295 UNIVERSAL JOINT 3/4"

- > Acc. to DIN 3123, ISO 3316
- > For hand-operated sockets with square drive as per DIN 3120, ISO 1174, with locking pin
- > GEDORE vanadium steel 31CrV3, chrome-plated



□"	■	□"	□	↳ mm	⚖ kg	Code	No.
3/4	20	3/4	20	108	0.580	6279170	3295

3294 COUPLER 3/4"

- > Acc. to DIN 3122, ISO 3315
- > For hand-operated sockets with square drive as per DIN 3120, ISO 1174, with locking pin
- > Chrome-vanadium steel, chrome-plated



□"	■	↳ mm	⚖ kg	Code	No.
3/4	20	51.5	0.133	6279090	3294

3219 REDUCER 3/4" TO 1/2"

- > Acc. to DIN 3123, ISO 3316
- > For hand-operated sockets with square drive as per DIN 3120, ISO 1174, with locking pin
- > GEDORE vanadium steel 31CrV3, chrome-plated



□"	□	■"	■	↳ mm	⚖ kg	Code	No.
3/4	20	1/2	12.5	56	0.168	6278010	3219

3221 CONVERTOR 3/4" TO 1"

- > Acc. to DIN 3123, ISO 3316
- > For hand-operated sockets with square drive as per DIN 3120, ISO 1174, with locking pin
- > GEDORE vanadium steel 31CrV3, chrome-plated



□"	□	■"	■	↳ mm	⚖ kg	Code	No.
3/4	20	1	25	60	0.337	6278280	3221

DVV-40ZRS

> 335



DVI-20L / DVI-28L

> 339



25 (1") square drive

25 1" 25 1"

Sets 25 (1") METRIC







25 1"

D 21 EMU-10
SOCKET SET 1"

15 pieces

- > With forged, tempered UD profile sockets, hand-operated
- > With accessories made from GEDORE vanadium steel 31CrV3
- > With reversible lever change ratchet
- > In GEDORE blue sheet steel case
- > Dimensions: 765 x 289 x 105 mm

25
1"
mm

Ratchet	Sockets	Accessories		Code	No.
 U-10 K 2193 U-10 K	 D 21 36 41 46 50 55 60 65 70 75 80	 2190-8 -16  2187 G  2187 K	31.4	6181600	D 21 EMU-10







Sets 25 (1") INCH

D 21 EAU-10
SOCKET SET 1"

15 pieces

- > With forged, tempered UD profile sockets, hand-operated
- > With accessories made from GEDORE vanadium steel 31CrV3
- > With reversible lever change ratchet
- > In GEDORE blue sheet steel case
- > Dimensions: 765 x 289 x 105 mm

25
1"
"AF

Ratchet	Sockets	Accessories		Code	No.
 U-10 K 2193 U-10 K	 D 21 1.1/2 1.5/8 1.7/8 2 2.1/16 2.1/4 2.3/8 2.9/16 2.3/4 3"	 2190-8 -16  2187 G  2187 K	34.9	6181790	D 21 EAU-10

Ratchets 25 (1")

2193 U-10
REVERSIBLE RATCHET 1"

- › Particularly for the demanding use experienced in industry and with utility vehicles
- › Acc. to DIN 3122, ISO 3315
- › With recessed lever change, locks in middle position
- › Return angle 11.25 degrees

- › Push-fit bar handle no. 2187 G
- › For hand-operated sockets and accessories with square drive as per DIN 3120 - D 25, ISO 1174 with locking pin
- › GEDORE vanadium steel 31CrV3, chrome-plated



Execution	■ "	■	∠°	l- mm -l	mm∅	kg	Code	No.
complete	1	25	11,25	810	61.5	5.210	6180550	2193 U-10
head only	1	25		184	61.5	1.980	6196120	2193 U-10 K
tommy bar				700		3.275	6195900	2187 G

2193 U-3
REVERSIBLE RATCHET 1"

- › Especially for working in confined spaces, as with utility vehicles
- › Acc. to DIN 3122, ISO 3315
- › With non-slip metal disc change, fine-toothed (72 teeth) and robust
- › Return angle 5 degrees

- › Push-fit tube handle
- › For hand-operated sockets and accessories with square drive as per DIN 3120 - D 25, ISO 1174, with locking pin
- › GEDORE vanadium steel 31CrV3, chrome-plated

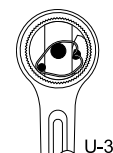

Execution	■ "	■	∠°	l- mm -l	mm∅	kg	Code	No.
complete	1	25	5	720	76	4.160	6180630	2193 U-3
head only	1	25				2.000	1637487	2193 U-3 K
tube						2.175	1382500	2193 Z/17

2193 Z-94
RATCHET HANDLE WITH COUPLER 1"

- › Used throughout industry and the automotive world
- › Acc. to DIN 3122, ISO 3315
- › With square coupler, medium-fine toothed, extremely rugged
- › Return angle 9 degrees

- › Push-fit tube handle
- › For hand-operated sockets and accessories with square drive as per DIN 3120 - D 25, ISO 1174 with locking pin
- › GEDORE vanadium steel 31CrV3, chrome-plated

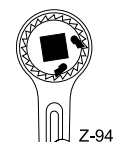

Execution	■ "	■	∠°	l- mm -l	mm∅	kg	Code	No.
complete	1	25	9	720	41	4.115	6181520	2193 Z-94
head only	1	25				1.175	1493779	2193 Z K
tube						2.175	1382500	2193 Z/17

Sockets 25 (1")

D 21 (MM)
SOCKET 1"

25
1"

bi-hexagon UD profile

- > Acc. to DIN 3124, ISO 2725-1
- > Square drive as per DIN 3120 - D 25, ISO 1174, with locking pin
- > Hand-operated, knurled grip
- > GEDORE vanadium steel 31CrV3, chrome-plated
- * not standardised

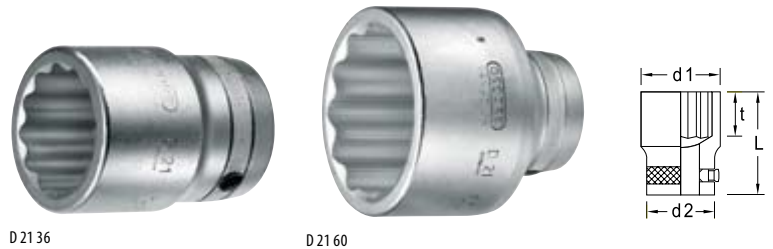

Ø mm	L	d ₁	d ₂	t		Code	No.
36	* 70.0	53.9	48.0	30.0	0.600	6174900	D 21 36
41	70.0	60.1	50.0	30.5	0.688	6175040	D 21 41
46	75.0	66.4	50.0	33.5	0.842	6175120	D 21 46
50	75.0	71.4	50.0	35.0	0.908	6175200	D 21 50
55	80.0	77.6	50.0	37.5	1.129	6175390	D 21 55

Ø mm	L	d ₁	d ₂	t		Code	No.
60	85.0	83.9	50.0	41.0	1.376	6175470	D 21 60
65	88.0	90.1	59.5	44.5	1.700	6175550	D 21 65
70	92.0	96.4	59.5	48.0	1.984	6175630	D 21 70
75	95.0	102.6	59.5	51.0	2.225	6175710	D 21 75
80	97.0	108.9	59.5	54.0	2.454	6175980	D 21 80

D 21 (AF)
SOCKET 1"

25
1"

bi-hexagon

- > Square drive as per DIN 3120 - D 25, ISO 1174, with locking pin
- > Hand-operated, knurled grip
- > GEDORE vanadium steel 31CrV3, chrome-plated



Ø AF	L	d ₁	d ₂	t		Code	No.
1.1/2	70.0	56.5	48.0	30.0	0.649	6176520	D 21 1.1/2AF
1.5/8	70.0	60.1	50.0	30.5	0.701	6176600	D 21 1.5/8AF
1.13/16	75.0	66.4	50.0	33.5	0.835	6176870	D 21 1.13/16AF
1.7/8	75.0	68.4	50.0	33.5	0.890	6176950	D 21 1.7/8AF
2	75.0	72.4	50.0	35.0	0.944	6177090	D 21 2AF
2.1/16	75.0	74.0	50.0	35.0	0.987	6177170	D 21 2.1/16AF
2.3/16	80.0	78.3	50.0	37.5	1.181	6177250	D 21 2.3/16AF
2.1/4	80.0	80.3	50.0	37.5	1.230	6177330	D 21 2.1/4AF
2.3/8	85.0	83.9	50.0	41.0	1.398	6177410	D 21 2.3/8AF

Ø AF	L	d ₁	d ₂	t		Code	No.
2.7/16	85.0	86.2	50.0	41.0	1.544	6177680	D 21 2.7/16AF
2.9/16	88.0	90.1	59.5	44.5	1.788	6177760	D 21 2.9/16AF
2.5/8	88.0	92.2	59.5	44.5	1.813	6177840	D 21 2.5/8AF
2.3/4	92.0	96.4	59.5	48.0	2.065	6177920	D 21 2.3/4AF
2.13/16	92.0	98.2	59.5	48.0	2.140	6178060	D 21 2.13/16AF
2.15/16	95.0	102.6	59.5	51.0	2.307	6178140	D 21 2.15/16AF
3	95.0	104.1	59.5	51.0	2.349	6178220	D 21 3AF
3.1/8	97.0	108.9	59.5	54.0	2.556	6178300	D 21 3.1/8AF

IN 21
SCREWDRIVER BIT SOCKET 1"

25
1"

for in-hex screws

- > Acc. to DIN 7422
- > Square drive as per DIN 3120 - D 25, ISO 1174, with locking pin
- > Hand-operated, knurled grip
- > Chrome-plated
- > With pressed-in pin in GEDORE vanadium special steel, manganese-phosphated
- * not standardised



Ø mm	L ₁	L ₂	d		Code	No.
17	90	25.5	48	0.613	6181010	IN 21 17
19	90	25.5	48	0.676	6181280	IN 21 19
22	90	25.5	48	0.733	6181360	IN 21 22
24	90	25.5	48	0.784	6181440	IN 21 24
27	* 90	25.5	48	0.856	6200680	IN 21 27

K 21

>246



Accessories 25 (1")

2187
SLIDING T BAR 1"

- > Acc. to DIN 3122, ISO 3315
- > For hand-operated sockets with square drive as per DIN 3120, ISO 1174, with locking pin
- > GEDORE vanadium steel 31CrV3, chrome-plated

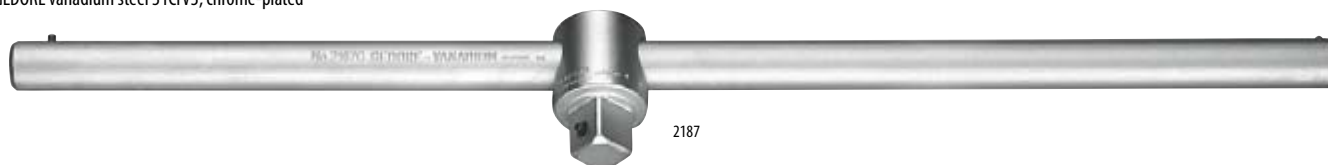

Execution	■"	■	↳ mm ↲	⚖	Code	No.
complete	1	25	700	3.955	6180120	2187
drive piece	1	25	80	0.680	6196040	2187 K
tommy bar			700	3.275	6195900	2187 G

2190
EXTENSION 1"

- > Acc. to DIN 3123, ISO 3316
- > For hand-operated sockets with square drive as per DIN 3120, ISO 1174, with locking pin
- > GEDORE vanadium steel 31CrV3, chrome-plated

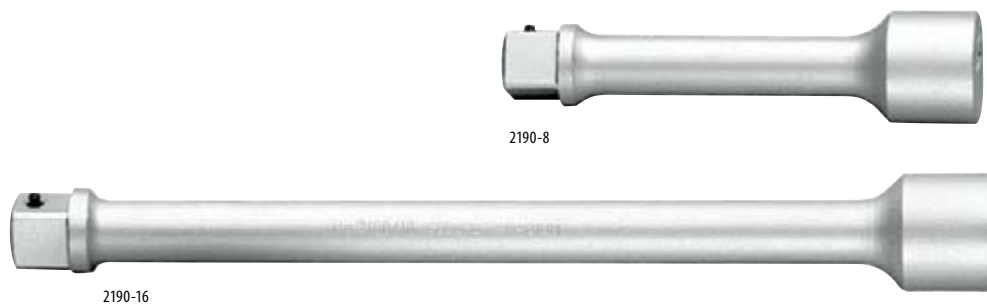

■"	■	↳ mm ↲	⚖	Code	No.
1	25	200	1.182	6180200	2190-8
1	25	400	2.144	6180390	2190-16

2194
COUPLER 1"

- > Acc. to DIN 3122, ISO 3315
- > For hand-operated sockets with square drive as per DIN 3120, ISO 1174, with locking pin
- > GEDORE vanadium steel 31CrV3, chrome-plated



■"	■	↳ mm ↲	⚖	Code	No.
1	25	67.5	0.321	6180710	2194

2132
REDUCER 1" TO 3/4"

- > Acc. to DIN 3123, ISO 3316
- > For hand-operated sockets with square drive as per DIN 3120, ISO 1174, with locking pin
- > GEDORE vanadium steel 31CrV3, chrome-plated

2195
UNIVERSAL JOINT 1"

- > For hand-operated sockets with square drive as per DIN 3120, ISO 1174, with locking pin
- > GEDORE vanadium steel 31CrV3, chrome-plated



■"	■	□"	□	↳ mm ↲	⚖	Code	No.	□"	□	■"	■	↳ mm ↲	⚖	Code	No.
1	25	1	25	140	1.482	6180980	2195	1	25	3/4	20	75	0.504	6180040	2132

Friction Type Ratchets

31 KR FRICTION TYPE RATCHET

with ring UD profile or bi-hexagon

- > Friction spanner (31 K) with exchangeable UD profile or bi-hexagon insert rings (31 R)
- > Hexagon rings are available on request
- > Especially in steel construction and scaffolding
- > Flat shaft up to 30", push-fit tube handle from 35"

- > GEDORE vanadium steel 31CrV3, manganese-phosphated
- > Explanation of the article number: 31 KR 16-32 = ratchet 31 K 16" and insert ring 31 R 32 mm

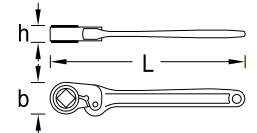

Ring	L	L"	h	b		Code	No.
8	150	6	11.5	23.0	0.093	6253020	31 KR 6-8
10	150	6	11.5	23.0	0.088	6253290	31 KR 6-10
13	150	6	11.5	23.0	0.082	6253530	31 KR 6-13
15	205	8	15.5	31.2	0.220	6253880	31 KR 8-15
17	205	8	15.5	31.2	0.212	6254180	31 KR 8-17
19	255	10	17.5	38.0	0.346	6254340	31 KR 10-19
21	255	10	17.5	38.0	0.336	6254500	31 KR 10-21
22	255	10	17.5	38.0	0.330	6254690	31 KR 10-22
24	305	12	18.5	44.6	0.497	6254850	31 KR 12-24
26	305	12	18.5	44.6	0.482	6255070	31 KR 12-26
27	305	12	18.5	44.6	0.474	6255150	31 KR 12-27
28	305	12	18.5	44.6	0.466	6255230	31 KR 12-28
30	400	16	19.5	51.6	0.709	6255580	31 KR 16-30

Ring	L	L"	h	b		Code	No.
32	400	16	19.5	51.6	0.684	6255740	31 KR 16-32
36	500	20	21.5	63.6	1.162	6256120	31 KR 20-36
41	500	20	21.5	63.6	1.098	6256470	31 KR 20-41
46	635	25	31.5	78.1	2.302	6256550	31 KR 25-46
50	635	25	31.5	78.1	2.213	6256630	31 KR 25-50
55	760	30	33.5	92.0	3.011	6256710	31 KR 30-55
60	760	30	33.5	92.0	2.879	6256980	31 KR 30-60
65	940	35	36.5	105.0	7.204	6257010	31 KR 35-65
70	940	35	36.5	105.0	7.023	6257280	31 KR 35-70
75	960	40	39.5	118.0	7.643	6257360	31 KR 40-75
80	960	40	39.5	118.0	7.392	6257440	31 KR 40-80

31 KVR FRICTION TYPE RATCHET

with square ring

- > Friction spanner (31 K) with exchangeable square insert rings (31 VR)
- > Especially in steel construction and scaffolding

- > GEDORE vanadium steel 31CrV3, manganese phosphated
- > Explanation of the article number: 31 KVR 8-12 = ratchet 31 K 8" and insert ring 31 VR 12 mm

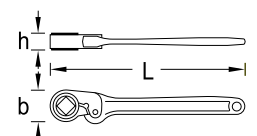

Ring	L	L"	h	b		Code	No.
8	150	6	11.5	23.0	0.091	6266000	31 KVR 6-8
9	150	6	11.5	23.0	0.089	6266190	31 KVR 6-9
10	150	6	11.5	23.0	0.087	6266270	31 KVR 6-10
12	205	8	15.5	31.2	0.228	6266430	31 KVR 8-12

Ring	L	L"	h	b		Code	No.
14	205	8	15.5	31.2	0.221	6266780	31 KVR 8-14
17	255	10	17.5	38.0	0.353	6267080	31 KVR 10-17
19	255	10	17.5	38.0	0.346	6267240	31 KVR 10-19

31 K

FRICION RATCHET HANDLE WITHOUT INSERT RING

- > Friction spanner for insert rings 31 R and 31 VR
- > Especially in steel construction and scaffolding
- > GEDORE vanadium steel 31CrV3, manganese-phosphated



Ring	Ring	L	L"	Head Ø		Code	No.
8-13	8-11	150	6	20	0.070	6243060	31 K 6
14-17	12-14	205	8	28	0.176	6243140	31 K 8
18-23	17-19	255	10	34	0.277	6243220	31 K 10
24-28		305	12	40	0.406	6243300	31 K 12
30-32		400	16	46	0.600	6243490	31 K 16
34-41		500	20	57	0.961	6243570	31 K 20

Ring	Ring	L	L"	Head Ø		Code	No.
46-50		635	25	70	1.880	6243650	31 K 25
55-60		760	30	82	2.435	6243730	31 K 30
65-70		940	35	96	6.305	6243810	31 K 35
75-80		960	40	108	6.480	6244030	31 K 40

31 R

INSERT RING FOR FRICTION RATCHET

UD profile or bi-hexagon

- > GEDORE vanadium steel 31CrV3, manganese-phosphated



Ring	Ø			Code	No.
8	19.7	6	0.021	6245000	31 R 8
10	19.7	6	0.018	6245270	31 R 10
13	19.7	6	0.011	6245510	31 R 13
14	27.6	8	0.047	6245780	31 R 14
15	27.6	8	0.044	6245860	31 R 15
16	27.6	8	0.040	6245940	31 R 16
17	27.6	8	0.036	6246080	31 R 17
18	33.6	10	0.075	6246160	31 R 18
19	33.6	10	0.069	6246240	31 R 19
21	33.6	10	0.059	6246400	31 R 21
22	33.6	10	0.053	6246590	31 R 22
24	39.6	12	0.091	6246750	31 R 24
26	39.6	12	0.076	6246910	31 R 26
27	39.6	12	0.069	6247050	31 R 27

Ring	Ø			Code	No.
28	39.6	12	0.061	6247130	31 R 28
30	45.6	16	0.109	6247480	31 R 30
32	45.6	16	0.084	6247640	31 R 32
36	56.6	20	0.201	6248020	31 R 36
41	56.6	20	0.137	6248370	31 R 41
46	70.0	25	0.422	6248450	31 R 46
50	70.0	25	0.333	6248530	31 R 50
55	82.0	30	0.576	6248610	31 R 55
60	82.0	30	0.444	6248880	31 R 60
65	96.0	35	0.899	6248960	31 R 65
70	96.0	35	0.718	6249180	31 R 70
75	108.0	40	1.163	6249260	31 R 75
80	108.0	40	0.912	6249340	31 R 80

31 VR

INSERT RING FOR FRICTION RATCHET

square

- > GEDORE vanadium steel 31CrV3, manganese-phosphated



Ring	Ø			Code	No.
8	19.7	6	0.021	6261200	31 VR 8
9	19.7	6	0.018	6261390	31 VR 9
10	19.7	6	0.017	6261470	31 VR 10
12	27.6	8	0.052	6261630	31 VR 12

Ring	Ø			Code	No.
14	27.6	8	0.045	6261980	31 VR 14
17	33.6	10	0.076	6262360	31 VR 17
19	33.6	10	0.069	6262520	31 VR 19

29 CONSTRUCTION RATCHET

bi-hexagon

> Reversible ratchet with two different size heads, bi-hexagon and "rat-tail" handle

> Especially in steel construction and scaffolding

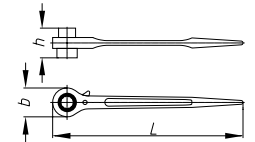

Ø	L	h	b	kg	Code	No.
17 x 19	315	49.0	42.0	0.463	1648934	29 17x19
19 x 22	315	49.5	42.0	0.448	1382853	29 19x22
19 x 24	365	56.0	51.5	0.757	1648926	29 19x24

Ø	L	h	b	kg	Code	No.
24 x 30	402	63.0	61.0	1.378	6262790	29 24x30
27 x 32	402	63.0	61.0	1.278	6262950	29 27x32
36 x 41	495	74.0	76.0	1.377	6263170	29 36x41

41 - 41 B REVERSIBLE LEVER CHANGE RATCHET

- > With permanently fixed UD profile insert
- > GEDORE vanadium steel 31CrV3, chrome-plated

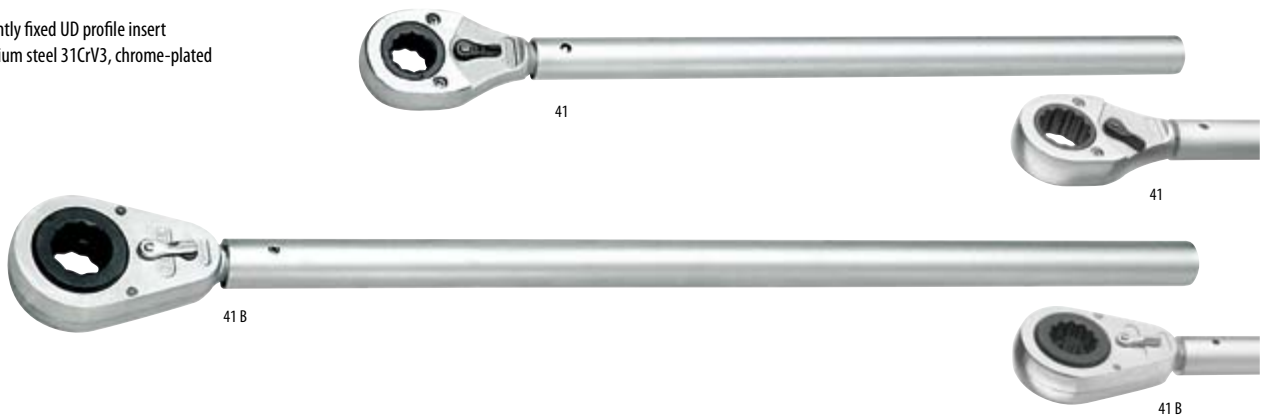

Ø	∠°	mm	mm	kg	Code	No.
22	11,25	27.9	620	2.455	6338790	41 22
24	11,25	27.9	620	2.430	6338870	41 24
27	11,25	27.9	620	2.410	6338950	41 27
28	11,25	27.9	620	2.393	6330030	41 28
30	11,25	27.9	620	2.365	6339170	41 30

Ø	∠°	mm	mm	kg	Code	No.
32	11,25	27.9	620	2.330	6339250	41 32
36	15,00	43.0	910	5.025	6338360	41 B 36
41	15,00	43.0	910	4.895	6338440	41 B 41
46	15,00	43.0	910	4.725	6338520	41 B 46

41 V - 41 BV REVERSIBLE LEVER CHANGE RATCHET

- > With permanently fixed square insert
- > Especially in steel construction and scaffolding
- > GEDORE vanadium steel 31CrV3, chrome-plated



Ø	∠°	mm	mm	kg	Code	No.
19	11,25	27.9	620	2.475	6339410	41 V 19
22	11,25	27.9	620	2.450	6339680	41 V 22
24	11,25	27.9	620	2.420	6339760	41 V 24
27	11,25	27.9	620	2.385	6339840	41 V 27

Ø	∠°	mm	mm	kg	Code	No.
30	15,00	43.0	910	5.115	6338600	41 BV 30
32	15,00	43.0	910	5.075	6339330	41 BV 32
36	15,00	43.0	910	4.970	6339920	41 BV 36

Impact Tools

6.3 (1/4") square drive

K 20 (MM) IMPACT SOCKET 1/4"

hexagon

- > Acc. to DIN 3129, ISO 2725-2
 - > Machine-operated, suitable for all standard electric and air tools
 - > Square drive as per DIN 3121 - G 6.3, ISO 1174
 - > GEDORE special steel, gun-metal finish
- * not standardised

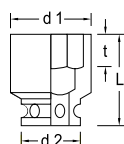

Ø mm	L	d ₁	d ₂	t	recommended accessories	⚖️	Code	No.
5.5	23	9.5	13	3	KB 2070, KB 2075	0.016	6198090	K 20 5,5
6.0	23	10.0	13	3	KB 2070, KB 2075	0.016	6198170	K 20 6
7.0	23	11.3	13	3	KB 2070, KB 2075	0.016	6198250	K 20 7
8.0	23	12.5	13	4	KB 2070, KB 2075	0.016	6198330	K 20 8
9.0	23	13.8	13	4	KB 2070, KB 2075	0.017	6198410	K 20 9
10.0	23	15.0	13	5	KB 2070, KB 2075	0.018	6198680	K 20 10
11.0	23	16.3	13	5	KB 2070, KB 2075	0.020	6198760	K 20 11
12.0	23	17.0	13	6	KB 2070, KB 2075	0.023	6198840	K 20 12
13.0	23	18.8	13	6	KB 2070, KB 2075	0.024	6198920	K 20 13
14.0	25	20.0	13	7	* KB 2070, KB 2075	0.035	6199060	K 20 14
17.0	26	23.8	13	7	* KB 2070, KB 2075	0.037	6199140	K 20 17

K 20 (AF) IMPACT SOCKET 1/4"

hexagon

- > Machine-operated, suitable for all standard electric and air tools
- > Square drive as per DIN 3121 - G 6.3, ISO 1174
- > GEDORE special steel, gun-metal finish

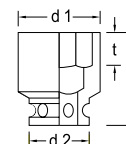

Ø"AF	L	d ₁	d ₂	t	recommended accessories	⚖️	Code	No.
3/16	23	8.5	13	3	KB 2070, KB 2075	0.015	6199220	K 20 3/16AF
1/4	23	10.3	13	3	KB 2070, KB 2075	0.017	6199300	K 20 1/4AF
5/16	23	12.5	13	3	KB 2070, KB 2075	0.016	6199490	K 20 5/16AF
3/8	23	15.0	13	4	KB 2070, KB 2075	0.018	6199570	K 20 3/8AF
7/16	23	16.3	13	6	KB 2070, KB 2075	0.021	6199650	K 20 7/16AF

KB 2090 EXTENSION 1/4"

for impact sockets

- > With square drive as per DIN 3121 - G 6.3, ISO 1174
- > GEDORE special steel, gun-metal finish



"	mm	⚖️	Code	No.
1/4	6.3	50	6201140	KB 2090-2

KB 2070 - KB 2075 SAFETY RING AND SAFETY PIN

for impact sockets 1/4"



KB 2070



KB 2075

Description	Ø	⚖️	Code	No.
Safety ring d 9 mm	9.0	0.005	6200920	KB 2070
Safety pin d 1.5 mm	1.5	10	6201060	KB 2075

10 (3/8") square drive

K 30

IMPACT SOCKET 3/8"

hexagon

- > Acc. to DIN 3129, ISO 2725-2
- > Machine-operated, suitable for all standard electric and air tools
- > Square drive as per DIN 3121 - G 10, ISO 1174
- > GEDORE special steel, gun-metal finish
- * not standardised

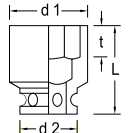

Ø mm	L	d ₁	d ₂	t	recommended accessories	kg	Code	No.
6	30	11.0	19	3.0	* KB 3070 6-12, KB 3075 6-12	0.045	6251160	K 30 6
7	30	12.5	19	3.0	KB 3070 6-12, KB 3075 6-12	0.046	6251240	K 30 7
8	30	14.5	19	4.0	KB 3070 6-12, KB 3075 6-12	0.046	6251320	K 30 8
9	30	15.0	19	4.0	KB 3070 6-12, KB 3075 6-12	0.046	6251400	K 30 9
10	30	16.0	19	5.0	KB 3070 6-12, KB 3075 6-12	0.046	6251590	K 30 10
11	30	17.5	19	5.0	KB 3070 6-12, KB 3075 6-12	0.046	6251670	K 30 11
12	30	19.0	19	6.0	KB 3070 6-12, KB 3075 6-12	0.046	6251750	K 30 12
13	30	19.0	22	6.0	KB 3070 13-24, KB 3075 13-24	0.063	6251830	K 30 13
14	30	21.0	22	7.0	KB 3070 13-24, KB 3075 13-24	0.063	6251910	K 30 14
15	30	22.0	22	7.0	KB 3070 13-24, KB 3075 13-24	0.062	6252050	K 30 15
16	30	24.0	22	8.0	KB 3070 13-24, KB 3075 13-24	0.066	6252130	K 30 16
17	30	25.0	22	9.0	KB 3070 13-24, KB 3075 13-24	0.068	6252210	K 30 17
18	30	26.0	22	9.0	KB 3070 13-24, KB 3075 13-24	0.075	6252480	K 30 18
19	30	27.5	22	9.5	KB 3070 13-24, KB 3075 13-24	0.076	6252560	K 30 19
20	30	28.0	22	10.0	* KB 3070 13-24, KB 3075 13-24	0.084	6252640	K 30 20
21	30	30.0	22	11.0	* KB 3070 13-24, KB 3075 13-24	0.089	6252720	K 30 21
22	30	32.0	23	11.0	* KB 3070 13-24, KB 3075 13-24	0.093	6252800	K 30 22
23	30	32.0	23	13.0	* KB 3070 13-24, KB 3075 13-24	0.095	6252990	K 30 23
24	30	35.0	23	13.0	* KB 3070 13-24, KB 3075 13-24	0.105	6254420	K 30 24

TX K 30

IMPACT SOCKET 3/8"

for protruding TORX® head screws

- > Machine-operated, suitable for all standard electric and air tools
- > Square drive as per DIN 3121 - G 10, ISO 1174
- > GEDORE special steel, gun-metal finish
- > TORX® = reg. trademark of Acument Intellectual Properties, LLC. USA

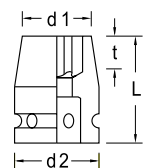

Ø	M	mm	L	d ₁	d ₂	t	recommended accessories	kg	Code	No.
E5	M4	4,73	32	9.0	19	5	KB 3070 6-12, KB 3075 6-12	0.042	6265030	TX K 30 E5
E6	M5	5,74	32	10.0	19	5	KB 3070 6-12, KB 3075 6-12	0.044	6265110	TX K 30 E6
E7	M6	6,16	32	10.0	19	7	KB 3070 6-12, KB 3075 6-12	0.044	6265380	TX K 30 E7
E8	M6 - M7	7,52	32	10.5	19	8	KB 3070 6-12, KB 3075 6-12	0.048	6265460	TX K 30 E8
E10	M8	9,42	32	12.5	19	9	KB 3070 6-12, KB 3075 6-12	0.048	6265540	TX K 30 E10
E12	M10	11,17	32	15.0	19	10	KB 3070 6-12, KB 3075 6-12	0.047	6265620	TX K 30 E12
E14	M12	12,90	32	19.0	19	12	KB 3070 6-12, KB 3075 6-12	0.046	6265700	TX K 30 E14

KB 3090 EXTENSION 3/8"

for impact sockets

- > With square drive as per DIN 3121 - G 10, ISO 1174
- > GEDORE special steel, manganese-phosphated



□"	■"	↳mm↳	⚖️	Code	No.
3/8	10	75	0.090	6261710	KB 3090-3
3/8	10	125	0.149	6262010	KB 3090-5
3/8	10	250	0.298	6262280	KB 3090-10

KB 3095 UNIVERSAL JOINT 3/8"

for impact sockets

- > With square drive as per DIN 3121 - G 10, ISO 1174
- > GEDORE special steel, manganese-phosphated



□"	□	■"	■"	↳mm↳	⚖️	Code	No.
3/8	10	3/8	10	50	0.072	6262440	KB 3095

KB 3019 CONVERTOR 3/8" TO 1/2"

for impact sockets

- > With square drive as per DIN 3121 - G 10, ISO 1174
- > GEDORE special steel, manganese-phosphated



□"	□	■"	■"	↳mm↳	⚖️	Code	No.
3/8	10	1/2	12.5	33	0.061	6263410	KB 3019

KB 3020 REDUCER 3/8" TO 1/4"

for impact sockets

- > With square drive as per DIN 3121 - G 10, ISO 1174
- > GEDORE special steel, manganese-phosphated



□"	□	■"	■"	↳mm↳	⚖️	Code	No.
3/8	10	1/4	6.3	31	0.034	6263250	KB 3020

KB 3070 - KB 3075 SAFETY RING AND SAFETY PIN

for impact sockets 3/8"



KB 3070



KB 3075

Description	∅	↳mm↳	⚖️	Code	No.
Safety ring d 14 mm	14.0		0.002	6260820	KB 3070 6-12
Safety ring d 15.5 mm	15.5		0.002	6260900	KB 3070 13-24
Safety pin d 2.5 mm	2.5	14	0.005	6261040	KB 3075 6-12
Safety pin d 2.5 mm	2.5	16	0.002	6261120	KB 3075 13-24

12.5 (1/2") square drive

K 19-028 IMPACT SOCKET SET 1/2"

5 pieces

- > 5 impact sockets, machine-operated, suitable for all standard electric and air tools
- > Square drive as per DIN 3121 - G 12.5, ISO 1174
- > GEDORE special steel, gun-metal finish
- > In black plastic case



K 19 LS-004 IMPACT SOCKET SET 1/2"

4 pieces

- > 4 impact sockets with protective sleeve, hexagon, long pattern
- > Machine-operated, suitable for all standard electric and air tools
- > Square drive as per DIN 3121 - G 12.5, ISO 1174
- > Thin-walled to protect the alloy wheels
- > GEDORE special steel, manganese-phosphated



Sockets		Code	No.
○ 10 13 17 19 24	0.749	1646923	K 19-028

Sockets		Code	No.
○ K 19 LS 17 19 21 22	0.980	2790831	K 19 LS-004

K 19 (MM) IMPACT SOCKET 1/2"

hexagon

- > Acc. to DIN 3129, ISO 2725-2
- > Machine-operated, suitable for all standard electric and air tools
- > Square drive as per DIN 3121 - G 12.5, ISO 1174
- > GEDORE special steel, gun-metal finish
- * not standardised

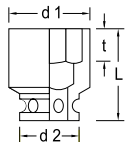

mm	L	d ₁	d ₂	t	recommended accessories		Code	No.
10	38	17.0	25	5.0	KB 1970 10-14, KB 1975 10-14	0.082	6160280	K 19 10
11	38	19.0	25	5.0	KB 1970 10-14, KB 1975 10-14	0.085	6160360	K 19 11
12	38	20.0	25	6.0	KB 1970 10-14, KB 1975 10-14	0.084	6160440	K 19 12
13	38	21.0	25	6.0	KB 1970 10-14, KB 1975 10-14	0.081	6160520	K 19 13
14	38	22.0	25	7.0	KB 1970 10-14, KB 1975 10-14	0.082	6160600	K 19 14
15	38	24.0	30	7.0	KB 1970 15-27, KB 1975 15-27	0.125	6161680	K 19 15
16	38	25.0	30	8.0	KB 1970 15-27, KB 1975 15-27	0.124	6160790	K 19 16
17	38	26.0	30	9.0	KB 1970 15-27, KB 1975 15-27	0.123	6160870	K 19 17
18	38	27.5	30	9.0	KB 1970 15-27, KB 1975 15-27	0.122	6160950	K 19 18
19	38	27.5	30	9.5	KB 1970 15-27, KB 1975 15-27	0.119	6161090	K 19 19
21	38	30.0	30	11.0	KB 1970 15-27, KB 1975 15-27	0.137	6161170	K 19 21
22	38	32.0	30	11.0	KB 1970 15-27, KB 1975 15-27	0.142	6161250	K 19 22
23	38	32.0	30	13.0	* KB 1970 15-27, KB 1975 15-27	0.148	6161330	K 19 23
24	45	35.0	30	13.0	KB 1970 15-27, KB 1975 15-27	0.154	6161410	K 19 24
27	50	38.0	30	13.0	KB 1970 15-27, KB 1975 15-27	0.180	6182680	K 19 27
30	50	41.0	30	16.0	* KB 1970 15-27, KB 1975 15-27	0.256	1560557	K 19 30
32	50	44.0	30	17.0	* KB 1970 15-27, KB 1975 15-27	0.286	1783742	K 19 32

K 19 (AF) IMPACT SOCKET 1/2"

hexagon

- > Machine-operated, suitable for all standard electric and air tools
- > Square drive as per DIN 3121 - G 12.5, ISO 1174
- > GEDORE special steel, gun-metal finish

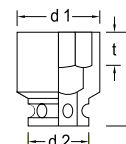

Ø"AF	L	d ₁	d ₂	t	recommended accessories	⚖️	Code	No.
3/8	38	16.0	25	4.0	KB 1970 10-14, KB 1975 10-14	0.079	6166990	K 19 3/8AF
7/16	38	18.0	25	6.0	KB 1970 10-14, KB 1975 10-14	0.079	6162300	K 19 7/16AF
1/2	38	20.0	25	6.0	KB 1970 10-14, KB 1975 10-14	0.078	6162650	K 19 1/2AF
9/16	38	22.0	25	7.0	KB 1970 10-14, KB 1975 10-14	0.080	6163030	K 19 9/16AF
5/8	38	25.0	25	8.0	KB 1970 15-27, KB 1975 15-27	0.121	6163460	K 19 5/8AF
11/16	38	25.0	25	9.0	KB 1970 15-27, KB 1975 15-27	0.121	6163700	K 19 11/16AF
3/4	38	27.5	30	9.5	KB 1970 15-27, KB 1975 15-27	0.115	6163970	K 19 3/4AF
13/16	38	30.0	30	11.0	KB 1970 15-27, KB 1975 15-27	0.131	6168420	K 19 13/16AF
7/8	38	32.0	30	13.0	KB 1970 15-27, KB 1975 15-27	0.141	6169820	K 19 7/8AF
15/16	38	35.0	30	13.0	KB 1970 15-27, KB 1975 15-27	0.156	6164190	K 19 15/16AF
1	38	35.0	30	13.0	KB 1970 15-27, KB 1975 15-27	0.169	6169900	K 19 1AF
1.1/16	50	38.0	30	13.0	KB 1970 15-27, KB 1975 15-27	0.173	6164350	K 19 1.1/16AF
1.1/8	40	38.0	30	16.5	KB 1970 15-27, KB 1975 15-27	0.180	6164510	K 19 1.1/8AF
1.1/4	40	44.0	35	17.0	KB 1970 15-27, KB 1975 15-27	0.284	6165240	K 19 1.1/4AF
1.5/16	43	45.0	35	19.0	KB 1970 15-27, KB 1975 15-27	0.296	6165320	K 19 1.5/16AF

K 19 L IMPACT SOCKET 1/2"

hexagon, long pattern

- > Machine-operated, suitable for all standard electric and air tools
- > Square drive as per DIN 3121 - G 12.5, ISO 1174
- > GEDORE special steel, manganese-phosphated

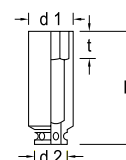

Ømm	L	d ₁	d ₂	t	recommended accessories	⚖️	Code	No.
8	77	15.3	25	12	KB 1970 10-14, KB 1975 10-14	0.124	6163110	K 19 L 8
10	77	17.8	25	12	KB 1970 10-14, KB 1975 10-14	0.140	6163380	K 19 L 10
13	77	21.5	25	13	KB 1970 10-14, KB 1975 10-14	0.158	6163540	K 19 L 13
14	77	22.8	25	13	KB 1970 10-14, KB 1975 10-14	0.171	6163620	K 19 L 14
16	77	24.0	30	14	KB 1970 15-27, KB 1975 15-27	0.208	6197790	K 19 L 16
17	80	26.5	30	15	KB 1970 15-27, KB 1975 15-27	0.230	6163890	K 19 L 17
18	82	27.8	30	15	KB 1970 15-27, KB 1975 15-27	0.255	6197870	K 19 L 18
19	82	29.0	30	17	KB 1970 15-27, KB 1975 15-27	0.265	6164000	K 19 L 19
21	82	31.5	30	17	KB 1970 15-27, KB 1975 15-27	0.306	6162730	K 19 L 21
22	82	32.8	30	19	KB 1970 15-27, KB 1975 15-27	0.318	6164270	K 19 L 22
23	82	34.0	30	19	KB 1970 15-27, KB 1975 15-27	0.328	6199810	K 19 L 23
24	82	35.3	30	21	KB 1970 15-27, KB 1975 15-27	0.358	6164430	K 19 L 24
27	82	39.0	30	22	KB 1970 15-27, KB 1975 15-27	0.396	6164780	K 19 L 27

K 19 LS

IMPACT SOCKET 1/2" WITH PROTECTIVE SLEEVE

hexagon, long pattern

- > Machine-operated, suitable for all standard electric and air tools
- > Square drive as per DIN 3121 - G 12.5, ISO 1174
- > Thin-walled to protect the alloy wheels
- > GEDORE special steel, manganese-phosphated

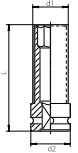

Ø mm	Colour	RAL	L	d ₁	d ₂	t	recommended accessories	kg	Code	No.
17	Traffic blue	5017	81	27.0	30	15	KB 1970 15-27, KB 1975 15-27	0.200	2178214	K 19 LS 17
19	Traffic green	6024	82	29.0	30	17	KB 1970 15-27, KB 1975 15-27	0.210	2178222	K 19 LS 19
21	Traffic red	3020	82	30.5	30	17	KB 1970 15-27, KB 1975 15-27	0.230	2178230	K 19 LS 21
22	Traffic yellow	1023	82	32.3	30	19	KB 1970 15-27, KB 1975 15-27	0.260	2178249	K 19 LS 22

KR 19

IMPACT SOCKET 1/2"

hexagon, for cars

- > Suitable for all standard electric and air tools
- > GEDORE special steel, gun-metal finish
- > Square drive as per DIN 3121 - G 12.5, ISO 1174

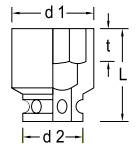

Ø mm	L	d ₁	d ₂	t	recommended accessories	kg	Code	No.
17	38	30	30	14	KB 1970 15-27, KB 1975 15-27	0.174	6162490	KR 19 17
19	38	33	30	18	KB 1970 15-27, KB 1975 15-27	0.186	6162570	KR 19 19

ITX K 19

IMPACT SCREWDRIVER BIT SOCKET 1/2"

for recessed TORX® head screws

- > Square drive as per DIN 3121 - G 12.5, ISO 1174
- > GEDORE special steel, manganese-phosphated
- > TORX® = reg. trademark of Acument Intellectual Properties, LLC. USA

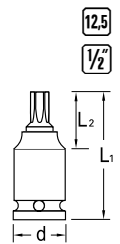

Ø	M	mm	L ₁	L ₂	d	recommended accessories	kg	Code	No.
T30	M6 - M7	5,52	47	26	25	KB 1970 10-14, KB 1975 10-14	0.075	6197280	ITX K 19 T30
T40	M7 - M8	6,65	47	26	25	KB 1970 10-14, KB 1975 10-14	0.077	6197360	ITX K 19 T40
T45	M8 - M10	7,82	47	26	25	KB 1970 10-14, KB 1975 10-14	0.078	1603124	ITX K 19 T45
T50	M10	8,83	47	26	25	KB 1970 10-14, KB 1975 10-14	0.079	6197440	ITX K 19 T50
T55	M12	11,22	47	26	25	KB 1970 10-14, KB 1975 10-14	0.084	6197520	ITX K 19 T55
T60	M14	13,25	47	26	25	KB 1970 10-14, KB 1975 10-14	0.088	6197600	ITX K 19 T60



TX K 19

IMPACT SOCKET 1/2"

for protruding TORX® head screws

- > Machine-operated, suitable for all standard electric and air tools
- > Square drive as per DIN 3121 - G 12.5, ISO 1174
- > GEDORE special steel, gun-metal finish
- > TORX® = reg. trademark of Acument Intellectual Properties, LLC. USA

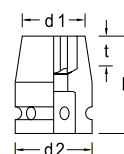

⊗	▣ M	★ mm	L	d ₁	d ₂	t	recommended accessories	⚖ kg	Code	No.
E10	M8	9,42	38	15.0	25	9	KB 1970 10-14, KB 1975 10-14	0.084	6223110	TX K 19 E10
E12	M10	11,17	38	16.0	25	10	KB 1970 10-14, KB 1975 10-14	0.085	6223380	TX K 19 E12
E14	M12	12,90	38	18.5	25	12	KB 1970 10-14, KB 1975 10-14	0.086	6223460	TX K 19 E14
E16	M12	14,76	38	20.0	25	12	KB 1970 10-14, KB 1975 10-14	0.088	6223540	TX K 19 E16
E18	M14	16,70	38	22.0	25	12	KB 1970 10-14, KB 1975 10-14	0.087	6223620	TX K 19 E18
E20	M16	18,45	38	25.0	30	13	KB 1970 15-27, KB 1975 15-27	0.140	6223700	TX K 19 E20
E24	M18 - M20	22,16	45	28.5	30	17	KB 1970 15-27, KB 1975 15-27	0.137	6223890	TX K 19 E24

IN K 19

IMPACT SCREWDRIVER BIT SOCKET 1/2"

for in-hex screws

- > Suitable for all standard electric and air tools
- > Square drive as per DIN 3121 - G 12.5, ISO 1174
- > GEDORE special steel, manganese-phosphated



IN K 19 5



IN K 19 17

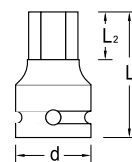

● mm	L ₁	L ₂	d	recommended accessories	⚖ kg	Code	No.
5	44	7.5	25	KB 1970 10-14, KB 1975 10-14	0.073	6223970	IN K 19 5
6	44	9.0	25	KB 1970 10-14, KB 1975 10-14	0.072	6224000	IN K 19 6
8	44	11.0	25	KB 1970 10-14, KB 1975 10-14	0.077	6224190	IN K 19 8
10	44	13.0	25	KB 1970 10-14, KB 1975 10-14	0.079	6224270	IN K 19 10
12	50	15.0	30	KB 1970 15-27, KB 1975 15-27	0.136	6224350	IN K 19 12
14	50	17.0	30	KB 1970 15-27, KB 1975 15-27	0.144	6225320	IN K 19 14
17	50	19.0	30	KB 1970 15-27, KB 1975 15-27	0.157	6225670	IN K 19 17

KB 1930 REDUCER 1/2" TO 3/8"

for impact sockets

- > With square drive as per DIN 3121 - G 12.5, Form F, G, and H
- > GEDORE special steel, manganese-phosphated



□"	□	■"	■	↳mm↳	⚖️	Code	No.
1/2	12.5	3/8	10	44	0.081	6650370	KB 1930

KB 1932 CONVERTOR 1/2" TO 3/4"

for impact sockets

- > With square drive as per DIN 3121 - G 12.5, Form F, G, and H
- > GEDORE special steel, manganese-phosphated



□"	□	■"	■	↳mm↳	⚖️	Code	No.
1/2	12.5	3/4	20	44	0.146	6650020	KB 1932

KB 1990 EXTENSION 1/2"

for impact sockets

- > With square drive as per DIN 3121 - G 12.5, ISO 1174 Form F, G, and H
- > GEDORE special steel, manganese-phosphated



KB 1990-5



KB 1990-10

■"	■	↳mm↳	⚖️	Code	No.
1/2	12.5	125	0.256	6655250	KB 1990-5
1/2	12.5	250	0.461	6650100	KB 1990-10

KB 1995 UNIVERSAL JOINT 1/2"

for impact sockets

- > With square drive as per DIN 3121 - G 12.5, Form F, G, and H
- > GEDORE special steel, manganese-phosphated



■"	■	□"	□	↳mm↳	⚖️	Code	No.
1/2	12.5	1/2	12.5	62	0.202	6655410	KB 1995

KB 1970 - KB 1975 SAFETY RING AND SAFETY PIN

for impact sockets 1/2"



KB 1970



KB 1975

Description	∅	↳mm↳	⚖️	Code	No.
Safety ring d 19 mm	19		0.002	6654790	KB 1970 10-14
Safety ring d 24 mm	24		0.002	6654870	KB 1970 15-27
Safety pin d 3 mm	3	20	0.002	6654950	KB 1975 10-14
Safety pin d 3 mm	3	25	0.002	6655090	KB 1975 15-27

20 (3/4") square drive

K 32-040

IMPACT SOCKET SET 3/4" FOR TRUCKS

20
3/4"

4 pieces

- > 4 sockets, machine-operated, suitable for all standard electric and air tools
- > Square drive as per DIN 3121 - H 20, ISO 1174
- > GEDORE special steel, gun-metal finish
- > In black plastic case



Sockets		Code	No.
○ 24 27 30 33	1.630	1828142	K 32-040

K 32 S

IMPACT SOCKET 3/4" WITH IMPACT-FIX LOCK

hexagon UD profile

- > Acc. to DIN 3129, ISO 2725-2
- > Machine-operated, suitable for all standard electric and air tools
- > Square drive as per DIN 3121 - H 20, ISO 1174
- > GEDORE vanadium steel 59CrV4
- > Gun-metal finish
- > DBGM (German utility patent)
- > Particularly suitable for working in sensitive areas permanently governed by certainty against loss, process reliability and occupational safety
- > Examples: overhead power line construction, wind power plants or the automotive sector

20
3/4"

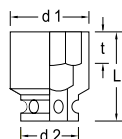

○ mm	L	d ₁	d ₂	t		Code	No.
17	45	31.1	44	7.0	0.400	2734060	K 32 S 17
18	45	32.4	44	8.4	0.420	2734079	K 32 S 18
19	45	33.6	44	8.4	0.400	2734095	K 32 S 19
22	46	37.4	44	9.8	0.400	2734176	K 32 S 22
24	46	39.9	44	11.2	0.340	2734184	K 32 S 24
27	48	43.6	44	12.6	0.400	2734206	K 32 S 27
30	52	47.4	44	14.0	0.400	2734214	K 32 S 30
32	52	49.9	44	15.4	0.400	2734230	K 32 S 32
33	54	51.0	44	15.4	0.400	2734257	K 32 S 33
34	54	52.4	44	15.4	0.400	2734265	K 32 S 34
36	56	54.9	44	16.8	0.500	2734273	K 32 S 36
38	59	57.0	44	16.8	0.500	2734281	K 32 S 38
41	59	61.1	44	18.9	0.560	2734303	K 32 S 41

K 32 SL

IMPACT SOCKET 3/4" WITH IMPACT-FIX LOCK

hexagon UD profile, long pattern

- > Machine-operated, suitable for all standard electric and air tools
- > Square drive as per DIN 3121 - H 20, ISO 1174
- > GEDORE vanadium steel 59CrV4
- > Gun-metal finish
- > DBGM (German utility patent)
- > Particularly suitable for working in sensitive areas permanently governed by certainty against loss, process reliability and occupational safety
- > Examples: overhead power line construction, wind power plants or the automotive sector

20
3/4"

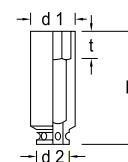

○ mm	L	d ₁	d ₂	t		Code	No.
17	90	31.1	44	7.0	0.560	2734311	K 32 SL 17
19	90	32.4	44	8.4	0.600	2734338	K 32 SL 19
21	90	36.1	44	9.8	0.600	2734346	K 32 SL 21
22	90	37.4	44	9.8	0.620	2734354	K 32 SL 22
24	90	39.9	44	11.2	0.620	2734362	K 32 SL 24
27	90	43.6	44	12.6	0.600	2734370	K 32 SL 27
30	90	47.4	44	14.0	0.600	2734389	K 32 SL 30
32	90	49.9	44	15.4	0.700	2734397	K 32 SL 32
33	90	51.0	44	15.4	0.800	2734400	K 32 SL 33
34	90	52.4	44	15.4	0.800	2734419	K 32 SL 34
36	90	54.9	44	16.8	0.800	2734427	K 32 SL 36
41	90	61.1	44	18.9	0.980	2734435	K 32 SL 41

K 32 (MM)

IMPACT SOCKET 3/4"

hexagon

- > Acc. to DIN 3129, ISO 2725-2
- > Machine-operated, suitable for all standard electric and air tools
- > Square drive as per DIN 3121 - H 20, ISO 1174
- > GEDORE special steel, gun-metal finish
- * not standardised

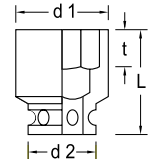

Ø mm	L	d ₁	d ₂	t	recommended accessories	🏋️	Code	No.
17	50	29	44	9.0	KB 3270, KB 3275	0.300	6282040	K 32 17
18	50	32	44	9.0	KB 3270, KB 3275	0.300	6289990	K 32 18
19	50	32	44	9.5	KB 3270, KB 3275	0.293	6282120	K 32 19
22	50	38	44	11.0	KB 3270, KB 3275	0.345	6282200	K 32 22
24	50	40	44	13.0	KB 3270, KB 3275	0.339	6282390	K 32 24
27	54	41	44	13.0	KB 3270, KB 3275	0.339	6282470	K 32 27
30	54	44	44	16.5	KB 3270, KB 3275	0.352	6282550	K 32 30

Ø mm	L	d ₁	d ₂	t	recommended accessories	🏋️	Code	No.
32	56	49	44	17.0	KB 3270, KB 3275	0.407	6282630	K 32 32
33	56	49	44	17.0	* KB 3270, KB 3275	0.430	6283010	K 32 33 (3/4W)
34	56	52	44	19.0	KB 3270, KB 3275	0.475	6281580	K 32 34
36	56	52	44	19.0	KB 3270, KB 3275	0.444	6282710	K 32 36
38	58	54	44	22.0	* KB 3270, KB 3275	0.481	6281740	K 32 38
41	58	57	44	22.0	KB 3270, KB 3275	0.500	6282980	K 32 41

K 32 (AF)

IMPACT SOCKET 3/4"

hexagon

- > Machine-operated, suitable for all standard electric and air tools
- > Square drive as per DIN 3121 - H 20, ISO 1174
- > GEDORE special steel, gun-metal finish

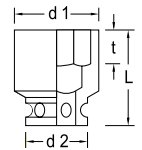

Ø "AF	L	d ₁	d ₂	t	recommended accessories	🏋️	Code	No.
13/16	46	35	44	11.0	KB 3270, KB 3275	0.349	6285300	K 32 13/16AF
7/8	46	38	44	13.0	KB 3270, KB 3275	0.354	6284410	K 32 7/8AF
15/16	46	40	44	13.0	KB 3270, KB 3275	0.342	6284680	K 32 15/16AF
1	46	41	44	13.0	KB 3270, KB 3275	0.340	6285490	K 32 1AF
1.1/16	48	41	44	13.0	KB 3270, KB 3275	0.347	6285650	K 32 1.1/16AF
1.1/8	52	44	44	16.5	KB 3270, KB 3275	0.367	6284760	K 32 1.1/8AF
1.1/4	52	49	44	17.0	KB 3270, KB 3275	0.418	6284840	K 32 1.1/4AF
1.5/16	55	49	44	19.0	KB 3270, KB 3275	0.417	6284920	K 32 1.5/16AF

Ø "AF	L	d ₁	d ₂	t	recommended accessories	🏋️	Code	No.
1.3/8	55	52	44	19.0	KB 3270, KB 3275	0.452	6285730	K 32 1.3/8AF
1.7/16	56	52	44	19.0	KB 3270, KB 3275	0.439	6285060	K 32 1.7/16AF
1.1/2	59	54	44	22.0	KB 3270, KB 3275	0.480	6285140	K 32 1.1/2AF
1.5/8	59	57	44	22.0	KB 3270, KB 3275	0.497	6285810	K 32 1.5/8AF
1.11/16	64	63	44	25.0	KB 3270, KB 3275	0.674	6286030	K 32 1.11/16AF
1.3/4	64	63	44	25.5	KB 3270, KB 3275	0.639	6286110	K 32 1.3/4AF
1.7/8	67	67	54	27.0	KB 3270, KB 3275	0.873	6286380	K 32 1.7/8AF
2	67	73	54	27.0	KB 3270, KB 3275	0.995	6286460	K 32 2AF

K 32 L

IMPACT SOCKET 3/4"

hexagon, long pattern

- > Machine-operated, suitable for all standard electric and air tools
- > Square drive as per DIN 3121 - H 20, ISO 1174
- > GEDORE special steel, gun-metal finish

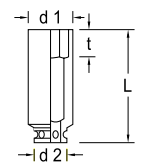

Ø mm	L	d ₁	d ₂	t	recommended accessories	🏋️	Code	No.
17	90	29	44	9.0	KB 3270, KB 3275	0.727	6283600	K 32 L 17
19	95	32	44	9.5	KB 3270, KB 3275	0.720	6283790	K 32 L 19
21	95	35	44	11.0	KB 3270, KB 3275	0.757	6286700	K 32 L 21
22	95	38	44	11.0	KB 3270, KB 3275	0.739	6283870	K 32 L 22
24	95	40	44	13.0	KB 3270, KB 3275	0.706	6283950	K 32 L 24
27	95	41	44	13.0	KB 3270, KB 3275	0.655	6284090	K 32 L 27

Ø mm	L	d ₁	d ₂	t	recommended accessories	🏋️	Code	No.
30	95	44	44	16.5	KB 3270, KB 3275	0.644	6284170	K 32 L 30
32	95	49	44	17.0	KB 3270, KB 3275	0.728	6284250	K 32 L 32
33	95	49	44	17.0	KB 3270, KB 3275	0.709	6286540	K 32 L 33 (3/4W)
34	95	52	44	19.0	KB 3270, KB 3275	0.858	6281660	K 32 L 34
36	95	52	44	19.0	KB 3270, KB 3275	0.826	6284330	K 32 L 36
41	95	57	44	22.0	KB 3270, KB 3275	0.811	6286890	K 32 L 41



IN K 32 IMPACT SCREWDRIVER BIT SOCKET 3/4"

for in-hex screws

- > Suitable for all standard electric and air tools
- > Square drive as per DIN 3121 - H 20, ISO 1174
- > GEDORE special steel, manganese-phosphated



mm	L ₁	L ₂	d	recommended accessories	kg	Code	No.
14	65	14	38	KB 3270, KB 3275	0.440	1956477	IN K 32 14
17	65	17	38	KB 3270, KB 3275	0.495	1956485	IN K 32 17
19	65	19	44	KB 3270, KB 3275	0.530	1956493	IN K 32 19
22	65	22	44	KB 3270, KB 3275	0.590	1956507	IN K 32 22
24	65	24	44	KB 3270, KB 3275	0.630	1956515	IN K 32 24
27	65	27	44	KB 3270, KB 3275	0.695	1956523	IN K 32 27

KB 3221 CONVERTOR 3/4" TO 1"

for impact sockets

- > With square drive as per DIN 3121, ISO 1174, Form F and H
- > GEDORE special steel, manganese-phosphated

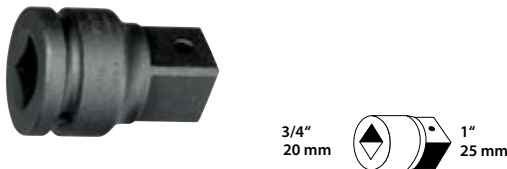

"	mm	"	mm	kg	Code	No.
3/4	20	1	25	65	6671530	KB 3221

KB 3295 UNIVERSAL JOINT 3/4"

for impact sockets

- > With square drive as per DIN 3121, ISO 1174, Form F and H
- > GEDORE special steel, manganese-phosphated



"	mm	"	mm	kg	Code	No.
3/4	20	3/4	20	94	6676090	KB 3295

KB 3219 REDUCER 3/4" TO 1/2"

for impact sockets

- > With square drive as per DIN 3121, ISO 1174, Form F and H
- > GEDORE special steel, manganese-phosphated

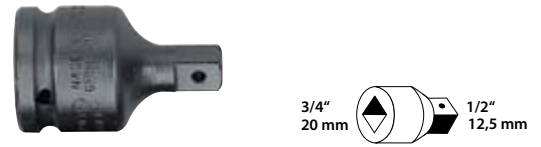

"	mm	"	mm	kg	Code	No.
3/4	20	1/2	12.5	65	6675280	KB 3219

KB 3290 EXTENSION 3/4"

for impact sockets

- > With square drive as per DIN 3121, ISO 1174, Form F and H
- > GEDORE special steel, manganese-phosphated



"	mm	kg	Code	No.
3/4	205	0.957	6675600	KB 3290-8
3/4	300	1.328	6675790	KB 3290-12
3/4	400	1.759	6675870	KB 3290-16

KB 3270 - KB 3275 SAFETY RING AND SAFETY PIN

for impact sockets 3/4"

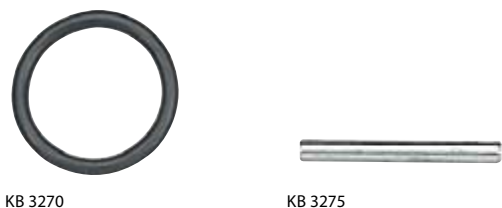

Description	Ø	mm	kg	Code	No.
Safety ring d 36 mm	36		0.004	6675360	KB 3270
Safety pin d 4 mm	4	35	0.004	6675440	KB 3275

IMPACT-FIX LOCK

Your advantages

- > Integrated, secure two-pin lock including ring
- > An extra feature from GEDORE - for increased safety in the workplace
- > Particularly suitable for working in sensitive areas permanently governed by certainty against loss, process reliability and occupational safety
- > Examples: overhead power line construction, wind power plants, machine engineering or the automotive sector
- > Very safe and extremely practice-oriented, and very easy to handle
- > Double ring groove for easily sliding the ring
- > Minimisation of the risk of injury compared to standard systems available on the market. The securing ring is not catapulted out of the rotating insert if the securing pin tears.
- > Wherever major forces prevail, correct and appropriate securing and handling of tools is a key element of good screwed connections.
- > Standard practice: the bothersome and awkward fitting of the loose securing pin and ring is often simply neglected or forgotten, or the pin and ring are no longer to be found.
- > Thanks to the Impact-Fix lock integrated in the socket, 3 elements no longer need to be installed (insert, pin and ring). The securing pins and rings are always secured to the socket (3 in 1). The pins are automatically pressed into the drill holes in the square drive when the ring is secured in place.
- > DBGM (German utility patent)



3 in 1

THE ADVANTAGE IS OBVIOUS:

thanks to the Impact-Fix lock integrated in the socket, three elements no longer need to be installed (insert, pin and ring).



MACHINE- OR HAND-OPERATED...

... electric, hydraulic, pneumatic or with torque multiplier by hand

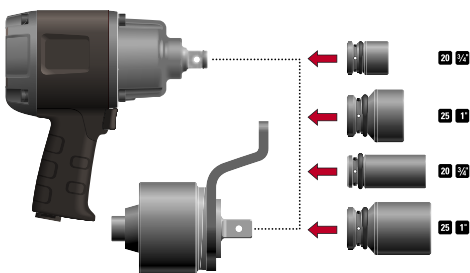

EASY TO USE ...

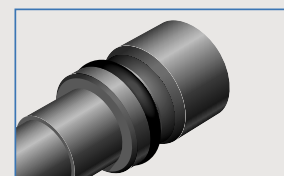
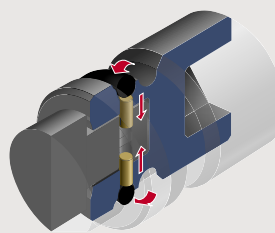
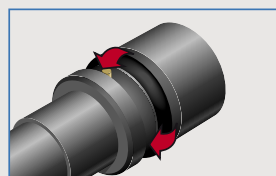
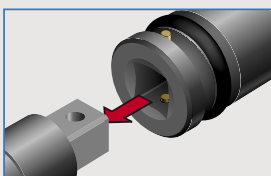

Double ring groove for easily sliding the ring thanks to integrated two-pin lock including ring.

K 21 (MM)

IMPACT SOCKET 1"

hexagon

- > Acc. to DIN 3129, ISO 2725-2
- > Machine-operated, suitable for all standard electric and air tools
- > Square drive as per DIN 3121 - H 25, ISO 1174
- > GEDORE special steel, gun-metal finish
- > Use KB 3770 and KB 3775 from 75 mm and up * not standardised

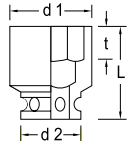

Ø mm	L	d ₁	d ₂	t	recommended accessories	⚖️	Code	No.
22	60	40	54	11.0	KB 2170, KB 2175	0.561	6183060	K 21 22
24	60	42	54	13.0	KB 2170, KB 2175	0.611	6183140	K 21 24
27	60	46	54	13.0	KB 2170, KB 2175	0.614	6183220	K 21 27
30	58	50	54	16.5	KB 2170, KB 2175	0.619	6183300	K 21 30
32	62	51	54	17.0	KB 2170, KB 2175	0.608	6183490	K 21 32
33	60	54	54	17.0	* KB 2170, KB 2175	0.615	6183650	K 21 33
34	62	54	54	19.0	KB 2170, KB 2175	0.624	6196980	K 21 34
36	67	54	54	19.0	KB 2170, KB 2175	0.598	6183570	K 21 36
38	67	60	54	19.0	* KB 2170, KB 2175	0.764	6184890	K 21 38
41	67	63	54	22.0	KB 2170, KB 2175	0.794	6183730	K 21 41

Ø mm	L	d ₁	d ₂	t	recommended accessories	⚖️	Code	No.
42	74	63	54	22.0	* KB 2170, KB 2175	0.781	6184970	K 21 42
46	74	70	54	25.5	KB 2170, KB 2175	0.974	6183810	K 21 46
50	80	73	54	27.0	KB 2170, KB 2175	1.018	6184030	K 21 50
55	84	82	54	30.0	KB 2170, KB 2175	1.298	6184110	K 21 55
60	87	86	54	33.0	KB 2170, KB 2175	1.481	6184380	K 21 60
65	90	92	54	35.0	KB 2170, KB 2175	1.682	6184460	K 21 65
70	96	96	54	38.0	KB 2170, KB 2175	1.812	6184540	K 21 70
75	98	100	86	41.0	* KB 3770, KB 3775	2.690	6184620	K 21 75
80	100	105	86	44.0	* KB 3770, KB 3775	2.936	6184700	K 21 80

K 21 (AF)

IMPACT SOCKET 1"

hexagon

- > Machine-operated, suitable for all standard electric and air tools
- > Square drive as per DIN 3121 - H 25, ISO 1174
- > GEDORE special steel, gun-metal finish

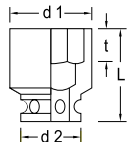

Ø "AF"	L	d ₁	d ₂	t	recommended accessories	⚖️	Code	No.
1	55	43	54	13.0	KB 2170, KB 2175	0.611	6186320	K 21 1AF
1.1/4	57	51	54	17.0	KB 2170, KB 2175	0.614	6186400	K 21 1.1/4AF
1.7/16	60	54	54	19.0	KB 2170, KB 2175	0.593	6186590	K 21 1.7/16AF
1.1/2	64	60	54	22.0	KB 2170, KB 2175	0.776	6186750	K 21 1.1/2AF

Ø "AF"	L	d ₁	d ₂	t	recommended accessories	⚖️	Code	No.
1.5/8	64	63	54	22.0	KB 2170, KB 2175	0.796	6186670	K 21 1.5/8AF
1.13/16	69	70	54	25.5	KB 2170, KB 2175	0.972	6186830	K 21 1.13/16AF
1.7/8	72	70	54	27.0	KB 2170, KB 2175	0.981	6186910	K 21 1.7/8AF
2.1/4	80	82	54	33.0	KB 2170, KB 2175	1.365	6187050	K 21 2.1/4AF

K 21 L

IMPACT SOCKET 1"

hexagon, long pattern

- > Machine-operated, suitable for all standard electric and air tools
- > Square drive as per DIN 3121 - H 25, ISO 1174
- > GEDORE special steel, gun-metal finish

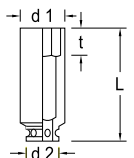

Ø mm	L	d ₁	d ₂	t	recommended accessories	⚖️	Code	No.
22	100	40	54	11.0	KB 2170, KB 2175	1.103	6185350	K 21 L 22
24	100	42	54	13.0	KB 2170, KB 2175	1.234	6185430	K 21 L 24
27	100	46	54	13.0	KB 2170, KB 2175	1.227	6185510	K 21 L 27
30	100	50	54	16.5	KB 2170, KB 2175	1.141	6185780	K 21 L 30
32	100	51	54	17.0	KB 2170, KB 2175	1.101	6185860	K 21 L 32
33	100	54	54	17.0	KB 2170, KB 2175	1.104	6197950	K 21 L 33

Ø mm	L	d ₁	d ₂	t	recommended accessories	⚖️	Code	No.
34	100	54	54	19.0	KB 2170, KB 2175	1.189	6197010	K 21 L 34
36	100	54	54	19.0	KB 2170, KB 2175	1.022	6185940	K 21 L 36
38	100	60	54	22.0	KB 2170, KB 2175	1.262	6186080	K 21 L 38
41	100	63	54	22.0	KB 2170, KB 2175	1.420	6186160	K 21 L 41
46	100	70	54	25.5	KB 2170, KB 2175	1.619	6186240	K 21 L 46

IN K 21 IMPACT SCREWDRIVER BIT SOCKET 1"

for in-hex screws

- > Suitable for all standard electric and air tools
- > Square drive as per DIN 3121 - H 25, ISO 1174
- > GEDORE special steel, manganese-phosphated



mm	L ₁	L ₂	d	recommended accessories	kg	Code	No.
19	75	21	54	KB 2170, KB 2175	0.650	1956558	IN K 21 19
22	75	24	54	KB 2170, KB 2175	0.675	1956566	IN K 21 22
24	75	26	54	KB 2170, KB 2175	0.700	1956574	IN K 21 24
27	75	28	54	KB 2170, KB 2175	0.730	1956582	IN K 21 27
30	75	29	54	KB 2170, KB 2175	0.770	1577514	IN K 21 30
32	75	30	54	KB 2170, KB 2175	0.900	1956590	IN K 21 32
36	75	30	54	KB 2170, KB 2175	0.860	1956604	IN K 21 36

KB 2132 REDUCER 1" TO 3/4"

for impact sockets

- > Square drive as per DIN 3121, ISO 1174, Form F and H
- > GEDORE special steel, manganese-phosphated

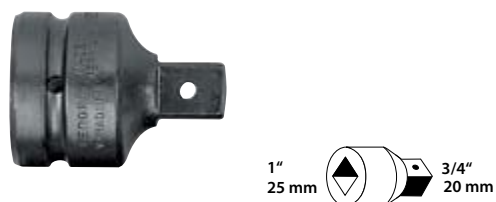

"	"	"	"	mm	kg	Code	No.
1	25	3/4	20	75	0.661	6657460	KB 2132

KB 2190 EXTENSION 1"

for impact sockets

- > Square drive as per DIN 3121, ISO 1174, Form F and H
- > GEDORE special steel, manganese-phosphated



"	"	mm	kg	Code	No.
1	25	208	1.477	6657970	KB 2190-8
1	25	300	2.010	6658000	KB 2190-12
1	25	405	2.587	6658190	KB 2190-16

KB 2137 CONVERTOR 1" TO 1.1/2"

for impact sockets

- > Square drive as per DIN 3121, ISO 1174, Form F and H
- > GEDORE special steel, manganese-phosphated



"	"	"	"	mm	kg	Code	No.
1	25	1.1/2	40	82	0.988	6657890	KB 2137

KB 2195 UNIVERSAL JOINT 1"

for impact sockets

- > Square drive as per DIN 3121, ISO 1174, Form F and H
- > GEDORE special steel, manganese-phosphated



"	"	"	"	mm	kg	Code	No.
1	25	1	25	140	1.425	6658350	KB 2195

KB 2170 - KB 2175 SAFETY RING AND SAFETY PIN 1"

for impact sockets 1"

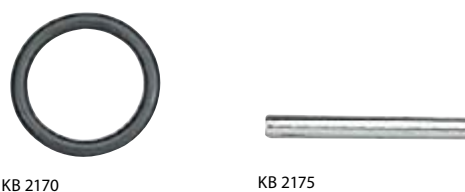

Description	Ø	mm	kg	Code	No.
Safety ring d 45 mm	45		0.008	6657620	KB 2170
Safety pin d 5 mm	5	45	0.007	6657700	KB 2175

40 (1.1/2") square drive

K 37 IMPACT SOCKET 1.1/2"

hexagon

- > Acc. to DIN 3129, ISO 2725-2
- > Machine-operated, suitable for all standard electric and air tools
- > Square drive as per DIN 3121 - H 40, ISO 1174
- > GEDORE special steel, gun-metal finish
- > Use KB 6470 and KB 6475 from 95 mm and up
- * not standardised

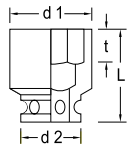

Ø mm	L	d ₁	d ₂	t	recommended accessories	⚖️	Code	No.
46	84	76	86	25.5	KB 3770, KB 3775	2.3	6328130	K 37 46
50	87	81	86	27.0	* KB 3770, KB 3775	2.3	6328210	K 37 50
55	90	86	86	30.0	KB 3770, KB 3775	2.5	6328480	K 37 55
60	92	93	86	33.0	KB 3770, KB 3775	2.7	6328560	K 37 60
65	95	97	86	35.0	KB 3770, KB 3775	3.2	6328640	K 37 65
70	100	105	86	38.0	KB 3770, KB 3775	3.5	6328720	K 37 70
75	103	110	86	41.0	KB 3770, KB 3775	3.7	6328800	K 37 75
80	110	116	86	44.0	KB 3770, KB 3775	4.2	6328990	K 37 80
85	118	125	86	47.0	KB 3770, KB 3775	4.8	6329020	K 37 85

Ø mm	L	d ₁	d ₂	t	recommended accessories	⚖️	Code	No.
90	118	130	86	49.0	KB 3770, KB 3775	5.5	6329100	K 37 90
95	118	137	95	49.0	* KB 6470, KB 6475	9.0	6329290	K 37 95
100	125	140	127	54.0	* KB 6470, KB 6475	8.1	6329370	K 37 100
105	125	150	127	54.0	* KB 6470, KB 6475	9.3	6329450	K 37 105
110	137	156	127	62.0	* KB 6470, KB 6475	10.6	6329530	K 37 110
115	137	160	127	67.0	* KB 6470, KB 6475	10.6	6329610	K 37 115
120	145	168	127	67.0	* KB 6470, KB 6475	11.8	6329880	K 37 120

K 37 L IMPACT SOCKET 1.1/2"

hexagon, long pattern

- > Machine-operated, suitable for all standard electric and air tools
- > Square drive as per DIN 3121 - H 40, ISO 1174
- > GEDORE special steel, gun-metal finish
- > Use KB 6470 and KB 6475 from 95 mm and up

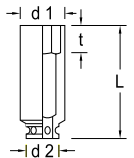

Ø mm	L	d ₁	d ₂	t	recommended accessories	⚖️	Code	No.
41	140	70	86	22.0	KB 3770, KB 3775	4.4	6330110	K 37 L 41
46	140	75	86	25.5	KB 3770, KB 3775	4.3	6330380	K 37 L 46
50	140	80	86	27.0	KB 3770, KB 3775	4.4	6330460	K 37 L 50
55	140	86	86	30.0	KB 3770, KB 3775	4.0	6330540	K 37 L 55
60	140	92	86	33.0	KB 3770, KB 3775	4.1	6330620	K 37 L 60
65	140	100	86	35.0	KB 3770, KB 3775	4.6	6330700	K 37 L 65
70	140	105	86	38.0	KB 3770, KB 3775	4.8	6330890	K 37 L 70
75	140	109	86	41.0	KB 3770, KB 3775	5.4	6330970	K 37 L 75
80	140	115	86	44.0	KB 3770, KB 3775	5.7	6331000	K 37 L 80

Ø mm	L	d ₁	d ₂	t	recommended accessories	⚖️	Code	No.
85	140	121	86	47.0	KB 3770, KB 3775	6.2	6331190	K 37 L 85
90	140	130	86	49.0	KB 3770, KB 3775	6.6	6331270	K 37 L 90
95	150	137	127	49.0	KB 6470, KB 6475	10.0	6331350	K 37 L 95
100	150	144	127	54.0	KB 6470, KB 6475	10.0	6331430	K 37 L 100
105	150	154	127	54.0	KB 6470, KB 6475	11.3	6331510	K 37 L 105
110	160	157	127	62.0	KB 6470, KB 6475	12.8	6331780	K 37 L 110
115	160	164	127	67.0	KB 6470, KB 6475	12.2	6331860	K 37 L 115
120	170	167	127	67.0	KB 6470, KB 6475	13.8	6331940	K 37 L 120

KB 3721 REDUCER 1.1/2" TO 1"

for impact sockets

- > Square drive as per DIN 3121, ISO 1174, Form F and H
- > GEDORE special steel, gun-metal finish



□ "	□	■ "	■	↳ mm ↳	⚖️	Code	No.
1.1/2	40	1	25	95	1.992	6676410	KB 3721

KB 3764

CONVERTOR 1.1/2" TO 2.1/2"

for impact sockets

- > Square drive as per DIN 3121, ISO 1174, Form F and H
- > GEDORE special steel, gun-metal finish



"	□	■"	■	∅	↳ mm ↳	⚖	Code	No.
1.1/2	40	2.1/2	63	86	93	3.6	1531220	KB 3764

KB 3770 - KB 3775

SAFETY RING AND SAFETY PIN

for impact sockets 1.1/2"



KB 3770



KB 3775

Description	∅	↳ mm ↳	⚖	Code	No.
Safety ring d 75 mm	75		0.026	6676760	KB 3770
Safety pin d 6 mm	6	75	0.017	6676840	KB 3775

63 (2.1/2") square drive

K 64

IMPACT SOCKET 2.1/2"

hexagon

- > Acc. to DIN 3129, ISO 2725-2
- > Machine-operated, suitable for all standard electric and air tools
- > Square drive as per DIN 3121 - H 63, ISO 1174
- > GEDORE special steel, gun-metal finish
- * not standardised

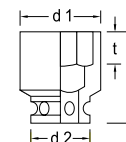

∅ mm	L	d ₁	d ₂	t	recommended accessories	⚖	Code	No.
75	125	115	127	41	KB 6470, KB 6475	7.4	6371300	K 64 75
80	125	115	127	44	KB 6470, KB 6475	7.0	6371490	K 64 80
85	130	127	127	47	KB 6470, KB 6475	7.3	6371570	K 64 85
90	132	135	127	49	KB 6470, KB 6475	8.0	6371650	K 64 90
95	132	140	127	49	KB 6470, KB 6475	8.1	6371730	K 64 95

∅ mm	L	d ₁	d ₂	t	recommended accessories	⚖	Code	No.
100	141	145	127	54	KB 6470, KB 6475	8.9	6371810	K 64 100
105	141	150	127	54	KB 6470, KB 6475	9.1	6372030	K 64 105
110	150	160	127	62	KB 6470, KB 6475	11.0	6372110	K 64 110
115	150	165	127	62	KB 6470, KB 6475	11.1	6372380	K 64 115
120	158	170	127	67	* KB 6470, KB 6475	12.0	6372460	K 64 120

KB 6437

REDUCER 2.1/2" TO 1.1/2"

for impact sockets

- > Square drive as per DIN 3121, ISO 1174, Form F and H
- > GEDORE special steel, gun-metal finish



"	□	■"	■	↳ mm ↳	⚖	Code	No.
2.1/2	63	1.1/2	40	138	7.090	6699700	KB 6437

KB 6470 - KB 6475

SAFETY RING AND SAFETY PIN

for impact sockets 2.1/2"



KB 6470



KB 6475

Description	∅	↳ mm ↳	⚖	Code	No.
Safety ring d 114 mm	114		0.040	6699890	KB 6470
Safety pin d 8 mm	8	110	0.043	6699970	KB 6475

Impact driver

K 1900 HAND-OPERATED IMPACT DRIVER 1/2"

- > Particularly suitable for loosening tight bolts or screws with the aid of a hammer
- > Reversible for right and left hand operation
- > Will fit any 1/2" impact socket or bit
- > Manganese-phosphated

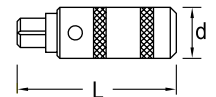

1/2"	12.5	L	d	kg	Code	No.
1/2	12.5	123	34	0.579	6654440	K 1900

K 1900-018 HAND-OPERATED IMPACT DRIVER SET 1/2"

18 pieces

- > Complete with the most frequently used bits, for use on screws and bolts with slotted, cross-head or hexagon heads
- > Reversible for right and left hand operation
- > In plastic case
- > Dimensions: 200 x 120 x 38 mm
- > TORX® = reg. trademark of Acument Intellectual Properties, LLC. USA



Contents	kg	Code	No.
⊖ 880 5,5 6,5 8 12 ● 885 4 5 6 8 10 ⊕ 890 2 3 4 ⊗ 887 TX T27 T30 T40 T45 KB 819 K 1900	1.249	6654600	K 1900-018

1500 ES-K 1900
>101

Bit range

690

SCREWDRIVER BIT 1/4", VALUE PACK

NEW



for cross-head screws PH

- > For hand operation and use in electric and air tools
- > Acc. to DIN ISO 2351-2, tip as per DIN ISO 8764-1 PH
- > Hexagon drive as per DIN 3126 - C 6.3 (1/4")
- > GEDORE special vanadium steel, gun-metal finish
- > 10-piece value packs

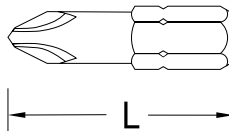

⊕ PH	L	Contents	⚖	Code	No.
0	25	10x	0.050	1803514	690 0 S-010
1	25	10x	0.050	6541240	690 1 S-010
1	50	10x	0.120	1828150	690 1 L S-010
2	25	10x	0.060	6541320	690 2 S-010
2	50	10x	0.120	6541400	690 2 L S-010
3	25	10x	0.060	6541590	690 3 S-010
3	50	10x	0.120	6541670	690 3 L S-010
4	32	10x	0.100	6541750	690 4 S-010

690 PZD

SCREWDRIVER BIT 1/4", VALUE PACK

NEW



for cross-head screws Pozi PZ

- > For hand operation and use in electric and air tools
- > Acc. to DIN ISO 2351-2, tip as per DIN ISO 8764-1 PZ
- > Hexagon drive as per DIN 3126 - C 6.3 (1/4")
- > GEDORE special vanadium steel, gun-metal finish
- > 10-piece value packs

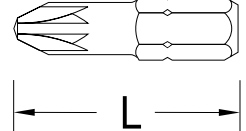

⊕ PZ	L	Contents	⚖	Code	No.
1	25	10x	0.050	6552790	690 PZD 1 S-010
1	50	10x	0.120	1827022	690 PZD 1 L S-010
2	25	10x	0.060	6552870	690 PZD 2 S-010
2	50	10x	0.120	6552950	690 PZD 2 L S-010
3	25	10x	0.060	6553090	690 PZD 3 S-010
3	50	10x	0.120	6553170	690 PZD 3 L S-010
4	32	10x	0.150	6553680	690 PZD 4 S-010

685

SCREWDRIVER BIT 1/4", VALUE PACK



for in-hex screws

- > For hand operation and use in electric and air tools
- > Acc. to DIN ISO 2351-3
- > Hexagon drive as per DIN 3126 - C 6.3 (1/4")
- > GEDORE special vanadium steel, gun-metal finish
- > 10- and 5-piece value packs

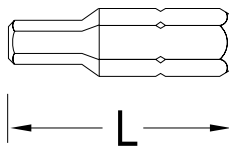

●	ISO 4762	DIN 7984	L	Contents	⚖	Code	No.
2	M2	M2	25	10x	0.050	1802399	685 2 S-010
2,5	M3	M4	25	10x	0.050	6538880	685 2,5 S-010
3	M4	M5	25	10x	0.050	6538960	685 3 S-010
4	M5	M6	25	10x	0.060	6539180	685 4 S-010
5	M6	M8	25	10x	0.060	6539260	685 5 S-010
6	M8	M10	25	10x	0.070	6539340	685 6 S-010
8	M10	M12	33	10x	0.090	6539420	685 8 S-010
10	M12	M14	33	5x	0.060	6539500	685 10 S-005

685 K

SCREWDRIVER BIT 1/4", VALUE PACK



for in-hex screws, with ball end

- > For hand operation and use in electric and air tools
- > Hexagon drive as per DIN 3126 - C 6.3 (1/4")
- > GEDORE special vanadium steel, gun-metal finish
- > 5-piece value packs

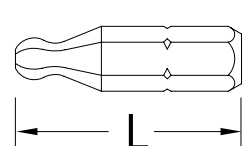

●	ISO 4762	DIN 7984	L	Contents	⚖	Code	No.
4	M5	M6	25	5x	0.030	2225700	685 K 4 S-005
5	M6	M8	25	5x	0.035	2225719	685 K 5 S-005
6	M8	M10	25	5x	0.040	2225727	685 K 6 S-005
8	M10	M12	33	5x	0.055	2225735	685 K 8 S-005
10	M12	M14	33	5x	0.070	2225743	685 K 10 S-005

687 TX SCREWDRIVER BIT 1/4", VALUE PACK

for recessed TORX® head screws

- > For hand operation and use in electric and air tools
- > Hexagon drive as per DIN 3126 - C 6.3 (1/4")
- > GEDORE special vanadium steel, gun-metal finish
- > 10-piece value packs
- > TORX® = reg. trademark of Acument Intellectual Properties, LLC. USA

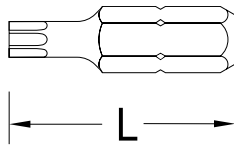

⊕	M	mm	L	Contents	kg	Code	No.
T6	M2	1,70	25	10x	0.050	6541830	687 TX T6 S-010
T7	M2,5	1,99	25	10x	0.050	6541910	687 TX T7 S-010
T8	M2,5	2,31	25	10x	0.050	6542050	687 TX T8 S-010
T9	M3	2,50	25	10x	0.050	6542130	687 TX T9 S-010
T10	M3 - M3,5	2,74	25	10x	0.050	6542210	687 TX T10 S-010
T15	M3,5 - M4	3,27	25	10x	0.050	6542480	687 TX T15 S-010
T20	M4 - M5	3,86	25	10x	0.050	6542560	687 TX T20 S-010
T25	M4,5 - M5	4,43	25	10x	0.060	6542640	687 TX T25 S-010
T27	M4,5 - M6	4,99	25	10x	0.060	6542720	687 TX T27 S-010
T30	M6 - M7	5,52	25	10x	0.060	6542800	687 TX T30 S-010
T40	M7 - M8	6,65	25	10x	0.070	6542990	687 TX T40 S-010

688 TX SCREWDRIVER BIT 1/4", VALUE PACK

for recessed TORX® head screws with pilot

- > For hand operation and use in electric and air tools
- > Hexagon drive as per DIN 3126 - C 6.3 (1/4")
- > GEDORE special vanadium steel, gun-metal finish
- > 10-piece value packs
- > TORX® = reg. trademark of Acument Intellectual Properties, LLC. USA

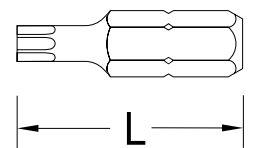

⊕	M	mm	L	Contents	kg	Code	No.
T10	M3 - M3,5	2,74	25	10x	0.050	6535510	688 TX T10 S-010
T15	M3,5 - M4	3,27	25	10x	0.050	6535780	688 TX T15 S-010
T20	M4 - M5	3,86	25	10x	0.050	6535860	688 TX T20 S-010
T25	M4,5 - M5	4,43	25	10x	0.060	6535940	688 TX T25 S-010
T27	M4,5 - M6	4,99	25	10x	0.060	6536080	688 TX T27 S-010
T30	M6 - M7	5,52	25	10x	0.060	6536160	688 TX T30 S-010
T40	M7 - M8	6,65	25	10x	0.060	6536240	688 TX T40 S-010

680 SCREWDRIVER BIT 1/4", VALUE PACK

for slotted head screws

- > For hand operation and use in electric and air tools
- > Acc. to DIN ISO 2351-1
- > Hexagon drive as per DIN 3126 - C 6.3 (1/4")
- > GEDORE special vanadium steel, gun-metal finish
- > 10- and 5-piece value packs

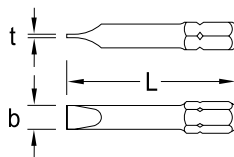

⊖	t	L	Contents	kg	Code	No.
4.0	0.5	25	10x	0.050	6537640	680 4 S-010
4.5	0.6	25	10x	0.050	6537720	680 4,5 S-010
5.5	0.8	25	10x	0.060	6537800	680 5,5 S-010
6.5	1.2	25	10x	0.060	6537990	680 6,5 S-010
7.0	1.2	25	10x	0.060	6538020	680 7 S-010
8.0	1.6	25	10x	0.070	6538100	680 8 S-010
10.0	1.6	39	5x	0.080	6538290	680 10 S-005

686 SCREWDRIVER BIT 1/4", VALUE PACK

for multi-spline screws RIBE®

- > For hand operation and use in electric and air tools
- > Hexagon drive as per DIN 3126 - C 6.3 (1/4")
- > GEDORE special vanadium steel, gun-metal finish
- > 10-piece value packs
- > RIBE® = reg. trademark of Richard Bergner GmbH & Co. KG, Schwabach, Germany

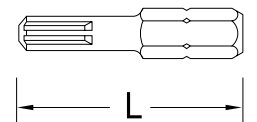

⊕	L	Contents	kg	Code	No.
M4	33	10x	0.060	6540510	686 4 S-010
M5	33	10x	0.070	6540780	686 5 S-010
M6	33	10x	0.080	6540860	686 6 S-010
M8	33	10x	0.110	6540940	686 8 S-010

685 X SCREWDRIVER BIT 1/4", VALUE PACK



for multi-point screws XZN

- > For hand operation and use in electric and air tools
- > Acc. to DIN ISO 65254
- > Hexagon drive as per DIN 3126 - C 6.3 (1/4"), tip as per DIN 2325
- > GEDORE special vanadium steel, gun-metal finish
- > 10-piece value packs

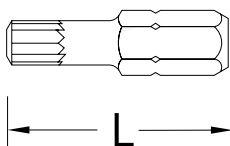

●	L	Contents	⚖️	Code	No.
M5	25	10x	0.060	6540000	685 X 5 S-010
M6	25	10x	0.060	6540190	685 X 6 S-010
M8	25	10x	0.080	6540270	685 X 8 S-010

689 TS SCREWDRIVER BIT 1/4" TORQ-SET®



- > For hand operation and use in electric and air tools
- > Acc. to DIN ISO 3126, ISO 1173
- > Hexagon drive as per DIN 3126 - C 6.3 (1/4")
- > GEDORE special vanadium steel, gun-metal finish
- > TORQ-SET® is a registered trademark of Phillips Screw Company, USA



●	Size	⚖️	Code	No.
2	0.006	1965506	689 TS 2	
4	0.006	1965514	689 TS 4	
6	0.006	1965522	689 TS 6	
8	0.006	1965530	689 TS 8	
10	0.006	1965549	689 TS 10	

20 XLU-3 T

>164



Bit sets 6.3 mm (1/4")

620-024 BIT SET 1/4"



24 pieces

- > In plastic case
- > Dimensions: 110 x 65 x 31 mm
- > TORX® = reg. trademark of Acument Intellectual Properties, LLC. USA

Bits	Accessories	⚖️	Code	No.
● 680 4 6,5	620	0.185	1815695	620-024
● 685 3 4 5 6				
● 685 X 5 6 8				
⊕ 690 1 2				
⊕ 690 PZD 1 2 3				
⊕ 687 TX T8 T9 T10 T15				
T20 T25 T27 T30 T40				



Accessories for bits 6.3 mm (1/4")

671 BIT REVERSIBLE RATCHET 1/4"



- > With knurled head for quick starting or counter-holding of screws
- > Hex recess drive as per DIN 3126 - D 6.3 (1/4")
- > Slim line design for working in confined spaces
- > Return angle 15 degrees
- > Non-slip 2-component handle with hanging hole



Hex"	Hex	Angle	Length	Weight	Code	No.
1/4	6.3	15	127	0.108	6535350	671

670 BIT SCREWDRIVER 1/4"



- > Hex recess drive as per DIN 3126 - D 6.3 (1/4"), for bits
- > Magnetic screw retainer
- > GEDORE vanadium steel

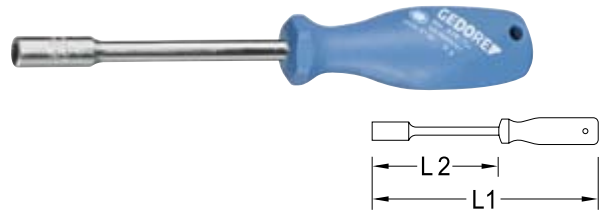

Hex"	Hex	L1	L2	Weight	Code	No.
1/4	6.3	210	100	0.140	6536590	670

670 K BIT SCREWDRIVER 1/4"

short pattern

- > Hex recess drive as per DIN 3126 - D 6.3 (1/4"), for bits
- > Magnetic screw retainer
- > GEDORE vanadium steel



Hex"	Hex	Length	Weight	Code	No.
1/4	6.3	80	0.100	1953796	670 K



169 MAGAZINE HANDLE SCREWDRIVER



- > For highest demands
- > With 1/4" recessed hexagon drive
- > Magnetic magazine handle with room for 7 bits
- > Cap with click-locking



Hex"	Hex	Contents	Length 1	Length 2	Weight	Code	No.
1/4	6.3	⊖ 680 4 5,5 6,5 ⊕ 690 1 2 ⊕ 690 PZD 1 2	115	220	0.206	6432700	169

674 BIT SCREWDRIVER

with reversible mechanism

- > Hexagon drive as per DIN 3126 - D 6.3 (1/4"), with powerful magnetic screw retainer
- > Smooth gear mechanism with knurled head for quick starting or counter-holding of screws
- > The blue handle makes it possible to tighten even hard-to-turn wood screws
- > The ratchet is reversible and fully lockable



Hex"	Hex	Length 1	Length 2	Weight	Code	No.
1/4	6.3	55	215	0.259	6530710	674



676 DRIVING HANDLE

- > Non-slip 2-component handle
- > Recessed hexagon drive 1/4"
- > Versatile use



Hex"	Hex	Weight	Code	No.
1/4	6.3	0.042	1649337	676

1500 CTD-20 BIT

>108



700 BIT HOLDER

magnetic

- > Quick-grip system for hex bits as per DIN 3126 - C 6.3 + E 6.3 (1/4")



Hex"	Hex	Hex"	Hex	Ø	Length mm	Weight kg	Code	No.
1/4	6.3	1/4	6.3	14	60.5	0.026	6530550	700

699 L BIT HOLDER LONG

long

- > Hexagon drive as per DIN 3126 - C 6.3 (1/4") and hex recess drive as per DIN 3126 - D 6.3 (1/4")
- > Hand operation
- > For use with driving handle, No. 676, or torque handle, No. 2140
- > With magnetic screw retainer



Hex"	Hex	Hex"	Hex	Length mm	Length mm	Weight kg	Code	No.
1/4	6.3	1/4	6.3	32	130	0.039	1802437	699 L

699 BIT HOLDER

for power tools

- > Acc. to DIN 7427 Form D
- > Hexagon drive as per DIN 3126 - E 6.3 (1/4") and hex recess drive as per DIN 3126 - D 6.3 (1/4")
- > With magnetic holder
- > Chrome-plated



Hex"	Hex	Hex"	Hex	Length mm	Length mm	Weight kg	Code	No.
1/4	6.3	1/4	6.3	30	60	0.023	6538610	699

673 L SOCKET HOLDER

long

- > 1/4" hexagon drive and square drive as per DIN 3120 - A 6.3 (1/4")
- > Hand operation
- > For use with driving handle no. 676, or torque handle no. 2140



Hex"	Hex	Hex"	Hex	Length mm	Weight kg	Code	No.
1/4	6.3	1/4	6.3	130	0.050	1811061	673 L

673 ADAPTOR

- > Acc. to DIN 7428, ISO 3317
- > Hexagon drive as per DIN 3126 - E 6.3 (1/4")
- > Square drive as per DIN 3121 for power-driven sockets
- > Also suitable for battery screwdrivers without impact effect



673 6,3



673 10

Hex"	Hex	Hex"	Hex	Length mm	Weight kg	Code	No.
1/4	6.3	1/4	6.3	50	0.016	6536320	673 6,3
3/8	10.0	1/4	6.3	50	0.026	1834878	673 10

673 K SOCKET HOLDER

short pattern

- > Hexagon drive as per DIN 3126 - E 6.3 (1/4")
- > Square drive as per DIN 3120 - A 6,3 (1/4")



Hex"	Hex	Hex"	Hex	Length mm	Weight kg	Code	No.
1/4	6.3	1/4	6.3	17	0.020	2000245	673 K

620 - 630 BIT ADAPTOR 1/4"

- > Hex recess drive as per DIN 3126 - D 6.3 (1/4") and square drive as per DIN 3120 - C 6.3 (1/4") / C 10 (3/8")



620



630

Hex"	Hex	Hex"	Hex	Length mm	Weight kg	Code	No.
1/4	6.3	1/4	6.3	25	0.020	1649329	620
1/4	6.3	3/8	10.0	25	0.025	1973312	630

KB 619 - KB 630 ADAPTOR PIECES

for screwdriver bits 1/4"

- > Acc. to DIN 7427 Form A
- > Hex recess drive as per DIN 3126 - D 6.3 (1/4") and square drive Form G as per DIN 3121
- > For hand-operated or power tools
- > For use in power tools, we recommend the use of a locking ring and pin
- > Manganese-phosphated
- * Length not standardised

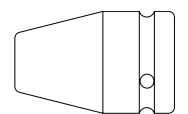

Length L

Hex"	Hex	Hex"	Hex	* L	Weight kg	Code	No.
1/4	6.3	1/2	12.5	35	0.072	6524150	KB 619
1/4	6.3	1/4	6.3	25	0.017	6524230	KB 620
1/4	6.3	3/8	10.0	* 30	0.040	6530040	KB 630

8 mm (5/16") hexagon drive

890 SCREWDRIVER BIT 5/16"



for cross-head screws PH

- > For hand operation and use in electric and air tools
- > For extra heavy use
- > Acc. to DIN ISO 2351-2, tip as per DIN ISO 8764-1 PH
- > Hexagon drive as per DIN 3126 - C 8 (5/16")
- > GEDORE special vanadium steel, gun-metal finish
- > Size 4: the length is not standardised

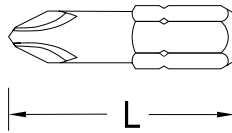

⊕ PH	L		Code	No.
1	32	0.010	6571580	890 1
2	32	0.010	6571660	890 2
3	32	0.010	6571740	890 3
4	32	0.012	6571820	890 4
4	38	0.015	6571900	890 4 L

890 PZD SCREWDRIVER BIT 5/16"



for cross-head screws Pozi PZ

- > For hand operation and use in electric and air tools
- > For extra heavy use
- > Acc. to DIN ISO 2351-2, tip as per DIN ISO 8764-1 PZ
- > Hexagon drive as per DIN 3126 - C 8 (5/16")
- > GEDORE special vanadium steel, gun-metal finish
- > Size 4: the length is not standardised

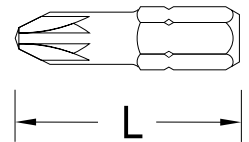

⊕ PZ	L		Code	No.
1	32	0.009	6553250	890 PZD 1
2	32	0.010	6553330	890 PZD 2
3	32	0.011	6553410	890 PZD 3
4	32	0.013	6553760	890 PZD 4

887 TX SCREWDRIVER BIT 5/16"



for recessed TORX® head screws

- > For hand operation and use in electric and air tools
- > For extra heavy use
- > Hexagon drive as per DIN 3126 - C 8 (5/16")
- > GEDORE special vanadium steel, gun-metal finish
- > TORX® = reg. trademark of Acument Intellectual Properties, LLC. USA

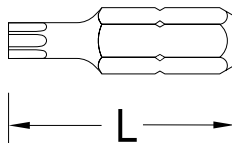

⊕			L		Code	No.
T27	M4,5 - M6	4,99	35	0.011	6571070	887 TX T27
T30	M6 - M7	5,52	35	0.012	6571150	887 TX T30
T40	M7 - M8	6,65	35	0.013	6571230	887 TX T40
T45	M8 - M10	7,82	35	0.014	6571310	887 TX T45
T50	M10	8,83	35	0.015	6575140	887 TX T50
T55	M12	11,22	35	0.021	2111225	887 TX T55

885 SCREWDRIVER BIT 5/16"



for in-hex screws

- > For hand operation and use in electric and air tools
- > For extra heavy use
- > Acc. to DIN ISO 2351-3
- > Hexagon drive as per DIN 3126 - C 8 (5/16")
- > GEDORE special vanadium steel, gun-metal finish

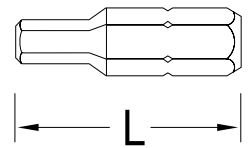

⊕	ISO 4762	DIN 7984	L		Code	No.
3	M4	M5	30	0.009	6568010	885 3
4	M5	M6	30	0.010	6568280	885 4
5	M6	M8	30	0.011	6568360	885 5
6	M8	M10	30	0.011	6568440	885 6
8	M10	M12	30	0.013	6568520	885 8
10	M12	M14	30	0.017	6568600	885 10

880 SCREWDRIVER BIT 5/16"

for slotted head screws

- > For hand operation and use in electric and air tools
- > For extra heavy use
- > Acc. to DIN ISO 2351-1
- > Hexagon drive as per DIN 3126 - C 8 (5/16")
- > GEDORE special vanadium steel, gun-metal finish

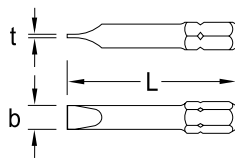

⊖	t	L		Code	No.
5.5	0.8	41	0.012	6566740	880 5,5
6.5	1.2	41	0.013	6566820	880 6,5
7.0	1.2	41	0.014	6566900	880 7
8.0	1.6	41	0.015	6567040	880 8
9.0	1.6	41	0.016	6567120	880 9
10.0	1.6	41	0.019	6567200	880 10
12.0	2.0	41	0.024	6567390	880 12
14.0	2.5	41	0.029	6567470	880 14

885 X SCREWDRIVER BIT 5/16"

for multi-point screws XZN

- > For hand operation and use in electric and air tools
- > For extra heavy use
- > Hexagon drive as per DIN 3126 - C 8 (5/16"), tip as per DIN 2325
- > GEDORE special vanadium steel, gun-metal finish

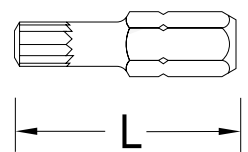

●	L		Code	No.
M5	28	0.009	6569170	885 X 5
M6	28	0.009	6569250	885 X 6
M8	28	0.011	6569330	885 X 8
M10	38	0.020	6569410	885 X 10
M12	38	0.025	6569680	885 X 12
M14	38	0.030	6569760	885 X 14

871 BIT REVERSIBLE RATCHET 5/16"

- > With knurled head for quick starting or counter-holding of screws
- > Hex recess drive as per DIN 3126 - D 8 (5/16")
- > Slim line design for working in confined spaces
- > Return angle 15 degrees
- > Non-slip 2-component handle with hanging hole



⊖"	⊖	∠°	┆mm┆	mm $\frac{1}{16}$		Code	No.
5/16	8	15	127	20.2	0.100	6535430	871

KB 819 - KB 830 ADAPTOR PIECES

for screwdriver bits 5/16"

- > Acc. to DIN 7427 Form A
- > Hex recess drive as per DIN 3126 - D 8 (5/16") and square drive Form G DIN 3121
- > For hand-operated or power tools
- > For use in power tools, we recommend the use of a locking ring and pin
- > Manganese-phosphated
- * Length not standardised

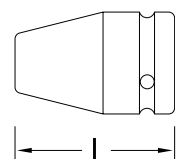

⊖"	⊖	⊖"	□	*	L		Code	No.
5/16	8	1/2	12.5		35	0.075	6563480	KB 819
5/16	8	1/4	6.3	*	25	0.018	6563560	KB 820
5/16	8	3/8	10.0		30	0.040	6563800	KB 830