

A close-up photograph of two cable ties. On the left, a black cable tie is shown with two black open-head fasteners. On the right, a white cable tie is shown with two white open-head fasteners. The background is a blurred mix of colors, including red, green, and blue.

Cable Management Solutions

**Q Series**

The cable tie fastening system with an innovative open-head design.

**HellermannTyton**

## Q Series

HellermannTyton's Q Ties feature a uniquely designed open-style head which provides a quick and simple solution for securely fastening and identifying cable or wire bundles in a wide range of applications. Ideal for use while working with gloves or in areas of limited visibility, the Q Tie blends ease of insertion with all the same high reliability of HellermannTyton's standard cable ties. This tie also has an integrated pre-locking function that permits for a temporary hold, making it the best option for applications where supplementary cables need to be added to cable runs prior to final assembly. Available in a range of sizes and materials, Q Ties can be tensioned by hand or with one of HellermannTyton's mechanical cable tie application tools.

The Q Series line includes Q Mounts and Q Tags, designed to work exclusively with the Q Ties. The Q Mounts are available with adhesive or can be secured with screws. The Q Tags are identification plates that can be marked using a permanent felt tip pen or by applying a thermal transfer label that has been pre-printed using the TagPrint Pro 3.0 label creation software and a HellermannTyton thermal transfer printer.



Q Ties



Q Mounts



Q Tags

## Features & Benefits

### Q Ties

- Open-head design with easily detectable slot opening allows for swift and easy insertion
- Pre-lock feature allows for a temporary hold
- The large ribbed tail permits a simple installation
- Two rails on the strap ensure guidance through the cable tie head

### Q Mounts

- 2- or 4-way entry options for the Q Tie, offer flexibility and stability

### Q Tags

- Opening on the tag allows the Q Tie to be easily inserted, providing a secure identification solution



Open-head design for easy installation.



Simple to use in any application.



Q Ties can be used for temporary and final cable assembly.

### Features of Q Ties

1. Open lock head for quick and easy insertion.
2. Two rails in the strap ensure a perfect guidance through the head.
3. The locking device interacts securely with the serration of the cable tie.
4. The tracks prevent deformation of the head under load.
5. The thin part of the cable tie is simply placed into the open head.
6. The large ribbed tail allows an ergonomic installation.
7. Integrated pre-locking feature (starts with type Q30).

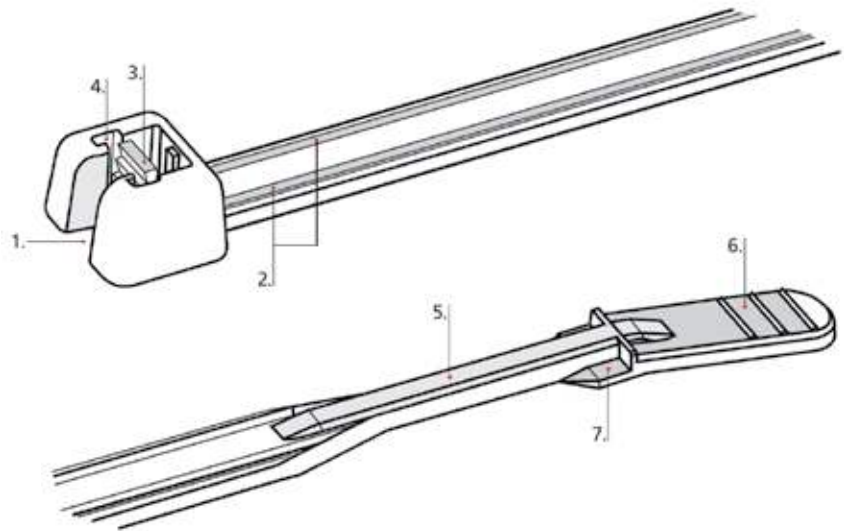

### Application Method

1. Insert the thin part of the cable tie into the open head.
2. Pull the tie through the head until the bundle is secured. Cut off the remaining part of the tie with a HellermannTyton application tool, which can be used with all HellermannTyton cable ties.



### Pre-locking Function of the Q Tie



1. Insert tail and pull back towards the head.

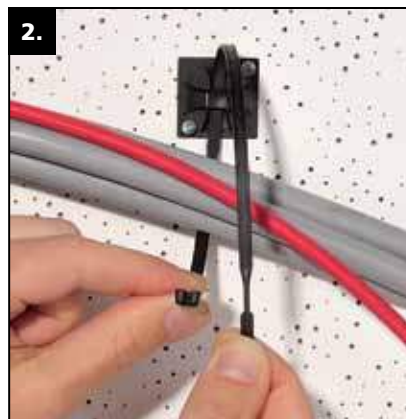

2. To release, push tail end slightly until removed from head.

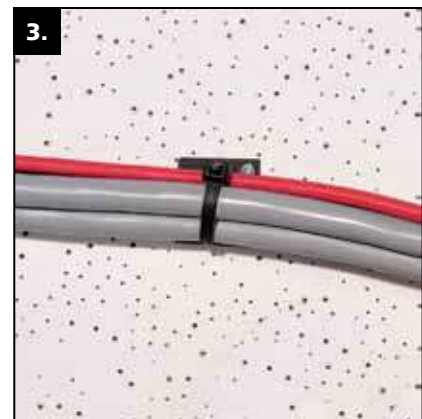

3. If installation is finished, Q Tie can be secured and cut off manually or with a HellermannTyton application tool.

### Q Ties (PA66)

Q Ties have a distinctive open-style head, a pre-lock function, and a large ribbed tail. The narrow section of the strap and open head offer ease of insertion, especially when working with gloves or for blind applications with limited view of the installation. The pre-lock feature allows for temporary holding of cable and wire bundles, permitting additional cables and wires to be placed without destroying the cable tie. Q Ties can be tensioned by hand or with one of HellermannTyton's mechanical cable tie application tools.



Q Ties are available in various sizes.

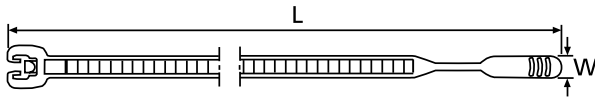

Material Data	
Material	Polyamide 6.6 (PA66)
Operating Temperature	-40 °F to +185 °F (-40 °C to +85 °C) continuous
Flammability	UL94 V2



Product Selection												
Article No.	Part No.	Type	Maximum Bundle Diameter		Minimum Tensile Strength		Length (L)		Width (W)		Color	Package Quantity
			in.	(mm)	lbs.	(N)	in.	(mm)	in.	(mm)		
109-00001	109-00001	Q18R	0.9	(24.0)	18.0	(80.0)	4.1	(105.0)	0.1	(2.6)	Natural (NA)	100
109-00004	109-00004	Q18I	1.6	(40.0)	18.0	(80.0)	6.1	(155.0)	0.1	(2.6)	Natural (NA)	100
109-00007	109-00007	Q18L	2.0	(50.0)	18.0	(80.0)	7.7	(195.0)	0.1	(2.6)	Natural (NA)	100
109-00010	109-00010	Q30R	1.5	(38.0)	30.0	(130.0)	6.3	(160.0)	0.14	(3.6)	Natural (NA)	100
109-00012	109-00012	Q30L	2.0	(50.0)	30.0	(130.0)	7.9	(200.0)	0.14	(3.6)	Natural (NA)	100
109-00014	109-00014	Q30LR	2.6	(65.0)	30.0	(130.0)	9.8	(250.0)	0.14	(3.6)	Natural (NA)	100
109-00018	109-00018	Q50R	2.0	(50.0)	50.0	(220.0)	8.3	(210.0)	0.19	(4.7)	Natural (NA)	100
109-00020	109-00020	Q50I	3.0	(75.0)	50.0	(220.0)	11.4	(290.0)	0.19	(4.7)	Natural (NA)	100
109-00022	109-00022	Q50L	4.3	(110.0)	50.0	(220.0)	16.1	(410.0)	0.19	(4.7)	Natural (NA)	100
109-00024	109-00024	Q120I	2.8	(70.0)	120.0	(530.0)	11.8	(300.0)	0.3	(7.7)	Natural (NA)	100
109-00026	109-00026	Q120R	4.3	(110.0)	120.0	(530.0)	16.5	(420.0)	0.3	(7.7)	Natural (NA)	100
109-00028	109-00028	Q120M	5.1	(130.0)	120.0	(530.0)	20.5	(520.0)	0.3	(7.7)	Natural (NA)	100
109-00030	109-00030	Q18R	0.9	(24.0)	18.0	(80.0)	4.1	(105.0)	0.1	(2.6)	Black (BK)	100
109-00033	109-00033	Q18I	1.6	(40.0)	18.0	(80.0)	6.1	(155.0)	0.1	(2.6)	Black (BK)	100
109-00036	109-00036	Q18L	2.0	(50.0)	18.0	(80.0)	7.7	(195.0)	0.1	(2.6)	Black (BK)	100
109-00039	109-00039	Q30R	1.5	(38.0)	30.0	(130.0)	6.3	(160.0)	0.14	(3.6)	Black (BK)	100
109-00041	109-00041	Q30L	2.0	(50.0)	30.0	(130.0)	7.9	(200.0)	0.14	(3.6)	Black (BK)	100
109-00043	109-00043	Q30LR	2.6	(65.0)	30.0	(130.0)	9.8	(250.0)	0.14	(3.6)	Black (BK)	100
109-00047	109-00047	Q50R	2.0	(50.0)	50.0	(220.0)	8.3	(210.0)	0.19	(4.7)	Black (BK)	100
109-00049	109-00049	Q50I	3.0	(75.0)	50.0	(220.0)	11.4	(290.0)	0.19	(4.7)	Black (BK)	100
109-00051	109-00051	Q50L	4.3	(110.0)	50.0	(220.0)	16.1	(410.0)	0.19	(4.7)	Black (BK)	100
109-00053	109-00053	Q120I	2.8	(70.0)	120.0	(530.0)	11.8	(300.0)	0.3	(7.7)	Black (BK)	100
109-00055	109-00055	Q120R	4.3	(110.0)	120.0	(530.0)	16.5	(420.0)	0.3	(7.7)	Black (BK)	100
109-00057	109-00057	Q120M	5.1	(130.0)	120.0	(530.0)	20.5	(520.0)	0.3	(7.7)	Black (BK)	100

Use Part No. for ordering and Type for specification purposes. Compatible tools for the Q Tie: EVO 7, MK7HT, MK7P, MK9, MK9HT, MK9P.



## Q Ties (PA66HS)

Q Ties made of PA66HS provide excellent resistance when exposed to high heat applications. Available in natural or black color.

Material Data	
Material	Polyamide 6.6 heat stabilized (PA66HS)
Operating Temperature	-40 °F to + 221 °F (-40 °C to +105 °C) continuous
Flammability	UL94 V2



Q Ties are available in various sizes.

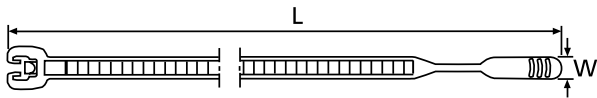

Product Selection		Type	Maximum Bundle Diameter		Minimum Tensile Strength		Length (L)		Width (W)		Color	Package Quantity
Article No.	Part No.		in.	(mm)	lbs.	(N)	in.	(mm)	in.	(mm)		
109-00117	109-00117	Q18R	0.9	(24.0)	18.0	(80.0)	4.1	(105.0)	0.1	(2.6)	Natural (NA)	100
109-00120	109-00120	Q18I	1.6	(40.0)	18.0	(80.0)	6.1	(155.0)	0.1	(2.6)	Natural (NA)	100
109-00123	109-00123	Q18L	2.0	(50.0)	18.0	(80.0)	7.7	(195.0)	0.1	(2.6)	Natural (NA)	100
109-00126	109-00126	Q30R	1.5	(38.0)	30.0	(130.0)	6.3	(160.0)	0.14	(3.6)	Natural (NA)	100
109-00128	109-00128	Q30L	2.0	(50.0)	30.0	(130.0)	7.9	(200.0)	0.14	(3.6)	Natural (NA)	100
109-00130	109-00130	Q30LR	2.6	(65.0)	30.0	(130.0)	9.8	(250.0)	0.14	(3.6)	Natural (NA)	100
109-00134	109-00134	Q50R	2.0	(50.0)	50.0	(220.0)	8.3	(210.0)	0.19	(4.7)	Natural (NA)	100
109-00136	109-00136	Q50I	3.0	(75.0)	50.0	(220.0)	11.4	(290.0)	0.19	(4.7)	Natural (NA)	100
109-00138	109-00138	Q50L	4.3	(110.0)	50.0	(220.0)	16.1	(410.0)	0.19	(4.7)	Natural (NA)	100
109-00140	109-00140	Q120I	2.8	(70.0)	120.0	(530.0)	11.8	(300.0)	0.3	(7.7)	Natural (NA)	100
109-00142	109-00142	Q120R	4.3	(110.0)	120.0	(530.0)	16.5	(420.0)	0.3	(7.7)	Natural (NA)	100
109-00144	109-00144	Q120M	5.1	(130.0)	120.0	(530.0)	20.5	(520.0)	0.3	(7.7)	Natural (NA)	100
109-00088	109-00088	Q18R	0.9	(24.0)	18.0	(80.0)	4.1	(105.0)	0.1	(2.6)	Black (BK)	100
109-00091	109-00091	Q18I	1.6	(40.0)	18.0	(80.0)	6.1	(155.0)	0.1	(2.6)	Black (BK)	100
109-00094	109-00094	Q18L	2.0	(50.0)	18.0	(80.0)	7.7	(195.0)	0.1	(2.6)	Black (BK)	100
109-00097	109-00097	Q30R	1.5	(38.0)	30.0	(130.0)	6.3	(160.0)	0.14	(3.6)	Black (BK)	100
109-00099	109-00099	Q30L	2.0	(50.0)	30.0	(130.0)	7.9	(200.0)	0.14	(3.6)	Black (BK)	100
109-00101	109-00101	Q30LR	2.6	(65.0)	30.0	(130.0)	9.8	(250.0)	0.14	(3.6)	Black (BK)	100
109-00105	109-00105	Q50R	2.0	(50.0)	50.0	(220.0)	8.3	(210.0)	0.19	(4.7)	Black (BK)	100
109-00107	109-00107	Q50I	3.0	(75.0)	50.0	(220.0)	11.4	(290.0)	0.19	(4.7)	Black (BK)	100
109-00109	109-00109	Q50L	4.3	(110.0)	50.0	(220.0)	16.1	(410.0)	0.19	(4.7)	Black (BK)	100
109-00111	109-00111	Q120I	2.8	(70.0)	120.0	(530.0)	11.8	(300.0)	0.3	(7.7)	Black (BK)	100
109-00113	109-00113	Q120R	4.3	(110.0)	120.0	(530.0)	16.5	(420.0)	0.3	(7.7)	Black (BK)	100
109-00115	109-00115	Q120M	5.1	(130.0)	120.0	(530.0)	20.5	(520.0)	0.3	(7.7)	Black (BK)	100

Use Part No. for ordering and Type for specification purposes. Compatible tools for the Q Tie: EVO 7, MK7HT, MK7P, MK9, MK9HT, MK9P.

### Q Mounts

HellermannTyton's Q Mounts are designed to work exclusively with the Q Tie cable tie series. This mounting component is available with adhesive or can be secured with screws. The Q Mount allows either a 2- or 4-way entry for the Q Tie, providing a quick and simple insertion into the mount. Once in place, the Q Tie will not slip out, even in vertical mounting applications.





4-way entry Q Mount is available as a screw mount or with adhesive.

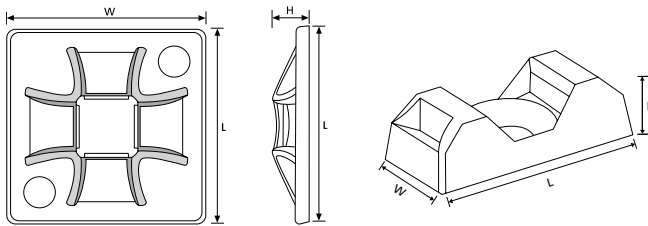

CTQM 2-way entry Screw Mount.



Material Data	
Material	Polyamide 6.6 (PA66)
Operating Temperature	-40 °F to +185 °F (-40 °C to +85 °C) continuous
Flammability	UL94 V2

Product Selection

Article No.	Part No.	Type	Length (L)		Width (W)		Height (H)		Mounting Hole Diameter (D)		Cable Tie Series	Color	Pkg. Qty.
			in.	(mm)	in.	(mm)	in.	(mm)	in.	(mm)			
<b>4-Way Screw Mount</b>													
151-10901	151-10901	QM20	0.79	(20.0)	0.79	(20.0)	0.14	(3.6)	0.12	(3.0)	Q18-Q50	Natural (NA)	100
151-10911	151-10911	QM20	0.79	(20.0)	0.79	(20.0)	0.14	(3.6)	0.12	(3.0)	Q18-Q50	Black (BK)	100
151-10902	151-10902	QM30	1.2	(30.0)	1.2	(30.0)	0.18	(4.6)	0.16	(4.0)	Q18-Q50	Natural (NA)	100
151-10912	151-10912	QM30	1.2	(30.0)	1.2	(30.0)	0.18	(4.6)	0.16	(4.0)	Q18-Q50	Black (BK)	100
151-10903	151-10903	QM40	1.6	(40.0)	1.6	(40.0)	0.23	(5.75)	0.16	(4.0)	Q18-Q120	Natural (NA)	50
151-10913	151-10913	QM40	1.6	(40.0)	1.6	(40.0)	0.23	(5.75)	0.16	(4.0)	Q18-Q120	Black (BK)	50
<b>4-Way Screw Mount With Adhesive</b>													
151-10904	151-10904	QM20A	0.79	(20.0)	0.79	(20.0)	0.17	(4.4)	0.12	(3.0)	Q18-Q50	Natural (NA)	100
151-10914	151-10914	QM20A	0.79	(20.0)	0.79	(20.0)	0.17	(4.4)	0.12	(3.0)	Q18-Q50	Black (BK)	100
151-10905	151-10905	QM30A	1.2	(30.0)	1.2	(30.0)	0.21	(5.4)	0.16	(4.0)	Q18-Q50	Natural (NA)	100
151-10915	151-10915	QM30A	1.2	(30.0)	1.2	(30.0)	0.21	(5.4)	0.16	(4.0)	Q18-Q50	Black (BK)	100
151-10906	151-10906	QM40A	1.6	(40.0)	1.6	(40.0)	0.26	(6.55)	0.16	(4.0)	Q18-Q120	Natural (NA)	50
151-10916	151-10916	QM40A	1.6	(40.0)	1.6	(40.0)	0.26	(6.55)	0.16	(4.0)	Q18-Q120	Black (BK)	50
<b>2-Way Screw Mount</b>													
151-10920	151-10920	CTQM5	0.83	(21.0)	0.38	(9.6)	0.26	(6.7)	0.18	(4.5)	Q18-Q50	Natural (NA)	100
151-10930	151-10930	CTQM5	0.83	(21.0)	0.38	(9.6)	0.26	(6.7)	0.18	(4.5)	Q18-Q50	Black (BK)	100

Use Part No. for ordering and Type for specification purposes.

## Q Tags

Q Tags are used in conjunction with the Q Tie cable tie series for labeling cables and wire bundles. The Q Tie is simply inserted through the Q Tag opening, providing a quick identification solution that also securely fastens the cable or wire bundle. The Q Tag can be marked using a permanent felt tip pen or by applying a thermal transfer label that has been pre-printed using the TagPrint Pro 3.0 label creation software and a HellermannTyton thermal transfer printer.



Q Tags are available in various sizes.

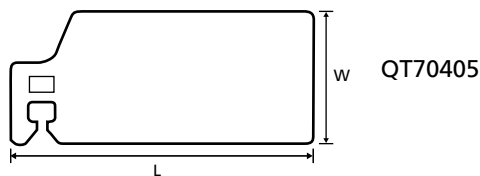
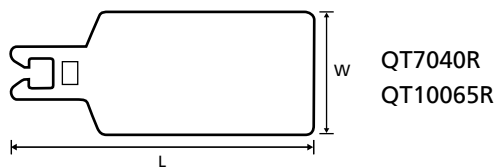
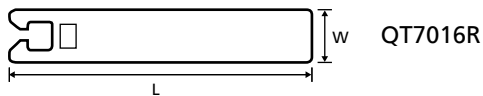

Material Data	
Material	Polyamide 6.6 (PA66)
Operating Temperature	-40 °F to +185 °F (-40 °C to +85 °C) continuous
Flammability	UL94 V2



Product Selection									
Article No.	Part No.	Type	Length (L)		Width (W)		Cable Tie Series	Color	Package Quantity
			in.	(mm)	in.	(mm)			
151-10950	151-10950	QT7016R	3.9	(100.0)	0.71	(18.0)	Q18-Q50	White	50
151-10951	151-10951	QT7040R	3.9	(100.0)	1.7	(42.0)	Q18-Q50	White	50
151-10952	151-10952	QT7040S*	3.9	(100.0)	1.7	(42.0)	Q18-Q30	White	50
151-10953	151-10953	QT10065R	5.3	(135.0)	2.6	(67.0)	Q18-Q50	White	25

\* Right angled.  
Use Part No. for ordering and Type for specification purposes.

Located in 34 countries, HellermannTyton brings the best to its customers through global resources channeled to local implementations. Flexibility, agility, and ability to create value-added, market driven solutions are the hallmarks of every HellermannTyton company across the world.



ARGENTINA | AUSTRALIA | AUSTRIA | BELGIUM | BRAZIL | CANADA | CHINA  
CZECH REPUBLIC | DENMARK | FINLAND | FRANCE | GERMANY | HONG KONG  
HUNGARY | IRELAND | ITALY | JAPAN | KOREA | MEXICO | NETHERLANDS | NORWAY | PHILIPPINES  
POLAND | PORTUGAL | ROMANIA | RUSSIAN FEDERATION | SINGAPORE | SLOVENIA | SOUTH AFRICA |  
SPAIN | SWEDEN | THAILAND | UNITED KINGDOM | UNITED STATES

---

# HellermannTyton

## **HellermannTyton North American Corporate Headquarters**

7930 N. Faulkner Rd, PO Box 245017  
Milwaukee, WI 53224-9517  
Phone: (414) 355-1130, (800) 537-1512  
Fax: (414) 355-7341, (800) 848-9866  
email: corp@htamericas.com  
www.hellermann.tyton.com

**TS16949, ISO 9001, and ISO14001 certified**

## **HellermannTyton Canada**

Unit #4, 205 Industrial Parkway North  
Aurora, Ontario L4G 4C4 Canada  
Phone: (800) 661-2461  
Fax: (800) 390-3904  
email: sales@hellermanntyton.ca

## **HellermannTyton Mexico**

Anillo Periferico Sur 7980 Edificio 2-D  
Parque Industrial Tecnologico II  
Santa María Tequepexpan  
Tlaquepaque, Jalisco, Mexico 45601  
Phone: 011-52-33-3-133-9880  
Fax: 011-52-33-3-133-9861  
email: info@htamericas.com.mx

**ISO 9001 certified**

## **Warranty Policy**

HellermannTyton products are warranted to be free from defects in material and workmanship at the time sold by us; but our obligation under this warranty and that of the seller is limited to the replacement of the product, and neither we nor the seller are bound by any other warranty, expressed, implied or statutory. Under no circumstances are we or the seller liable for any loss, damage, expenses or consequential damages of any kind arising out of the use or inability to use these products. All are sold with the understanding that the user will test them in actual use and determine their adaptability for the intended uses.