

FX 10 - 4 Ohm

Art. No. 4692



10 cm (4") 2-Wege-Koaxiallautsprecher mit Euro-Normkorb. Integrierte Frequenzweiche (Kondensator) für den Hochtöner. Einfache Montage in Fahrzeugen mit Einbauorten für 10 cm-Lautsprecher. Wasserfeste Polypropylenmembran.

10 cm (4") 2-way coaxial loudspeaker with standard basket. Integrated crossover (capacitor) for the tweeter. Straightforward installation in vehicles with cutouts for 10 cm speakers. Waterproof PP-cone.

Anwendungsmöglichkeiten / Typical applications

- Fahrzeuge
- Reisemobile

- Vehicles
- Mobile homes

01.10.2015

Eigenschaften / Attributes

- Wasserfeste Membran
- Metallkorb
- Koaxiallautsprecher

- Waterproof cone
- Metal basket
- Coaxial speaker

FX 10 - 4 Ohm

Art. No. 4692

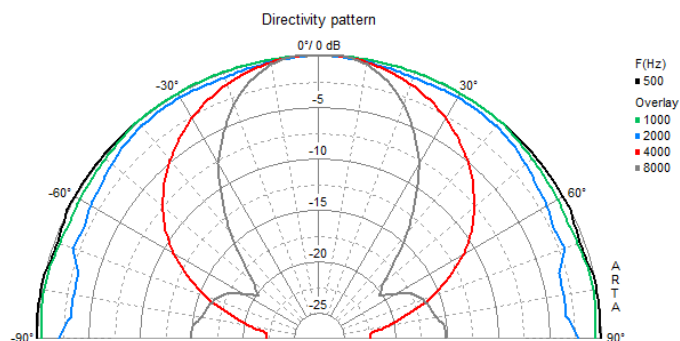
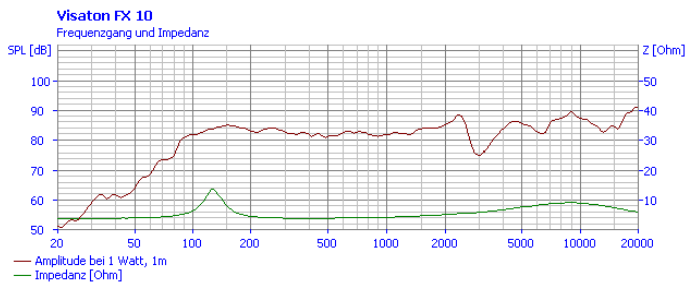
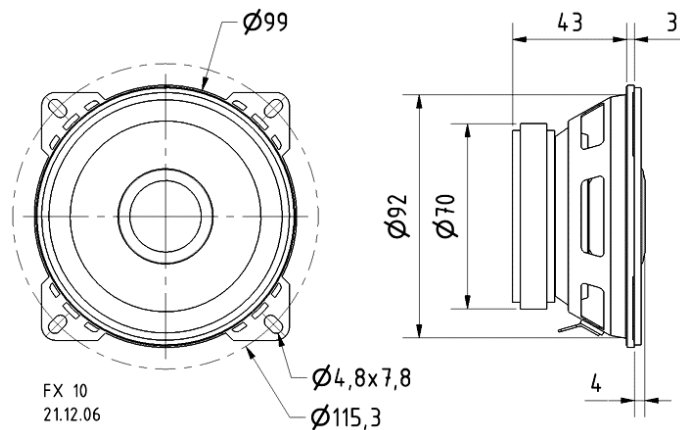

Technische Daten / Technical data

Nennbelastbarkeit Rated power	40 W
Musikbelastbarkeit Maximum power	70 W
Nennimpedanz Z Nominal impedance Z	4 Ohm
Übertragungsbereich Frequency response	70–22000 Hz
Mittlerer Schalldruckpegel Mean sound pressure level	84 dB (1 W/1 m)
Abstrahlwinkel (-6 dB) Opening angle (-6 dB)	88°/4000 Hz
Grenzauslenkung Excursion limit	+/-2 mm
Resonanzfrequenz fs Resonance frequency fs	110 Hz
Obere Polplattenhöhe Height of front pole-plate	3 mm
Schwingspulendurchmesser Voice coil diameter	25 mm
Wickelhöhe Height of winding	6 mm
Schallwandöffnung Cutout diameter	93 mm
Gewicht netto Net weight	0,4 kg
Anschlüsse Connections	4,8 x 0,8 mm (+) 2,8 x 0,8 mm (-)
Temperaturbereich Temperature range	-25 ... 70 °C

01.10.2015