

Amplifier Built-in
Digital Mark Sensor
LX-100 SERIES



LX-100 SERIES



PNP output
type available



Timer



Automatic
sensitivity setting

Introduction of the 3 LED mark sensor

Can detect any mark!

Coaxial reflective optics and a sharp $1 \times 5 \text{ mm}$ $0.039 \times 0.197 \text{ in}$ spot enable high precision sensing. Stable detection of marks is possible.



R•G•B light emitting elements all in one

To detect any marking, this unit is equipped with red, green and blue LED light emitting elements all in one.

High precision coaxial reflective optical system

Panasonic Industry unique coaxial reflective optics technology ensures very accurate sensing. The unit is made with a scratchproof glass lens.

Total reflection mirror

Half mirror

Glass lens



▲ Image schematic

4-digit digital display

The 4-digit digital display enables numerical sensing control and minute settings.

Operation panel

3 large buttons that click into position making operation easy.

Highest in the industry

12-bit A/D converter

A resolution of $1/4,000$ is realized to enable high precision mark sensing.

Receiving element

Protection IP67

Washing the machines and production line with water will not affect the sensor thanks to its waterproof construction.

Spot size $1 \times 5 \text{ mm}$
 $0.039 \times 0.197 \text{ in}$ approx.

Automatic optimal LED selection function

The 3 colors of the R•G•B LEDs are optimally selected according to the color combination. With the LX-100's Mark mode, the built-in "Automatic optimal LED selection function" automatically selects the LED for the largest contrast (S/N ratio) between the mark and base (non-mark area) to ensure optimal sensing. For more stable detection, the sensor makes selection according to the contrast and not according to the reflected light variation between the mark and base (non-mark area).

(The example on the right deals with reflected light on packing film.)
Great figures are indicated for the blue LED's light amount ratio and, for even more stable sensing, the blue LED effectuates this mark sensing.

Example: A packing film

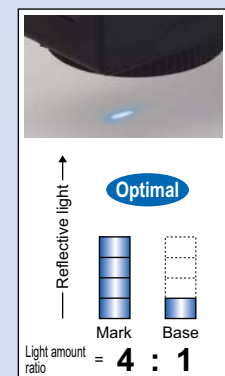
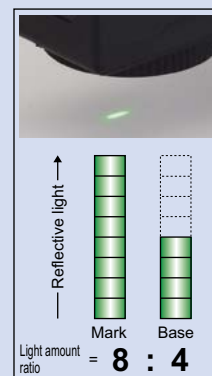
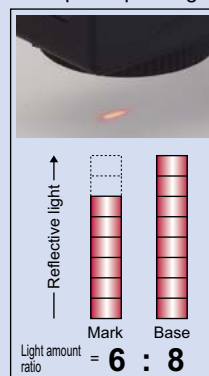

Two detection modes can be selected from to suit the application

Mark mode Ultra high-speed response

This sensing mode automatically selects a single color from the 3 R•G•B LEDs to achieve an ultra quick 45 μs response time. The automatic optimal LED selection function automatically selects the LED that is most suitable for the sensing. This function is perfect for ultra quick sensing.

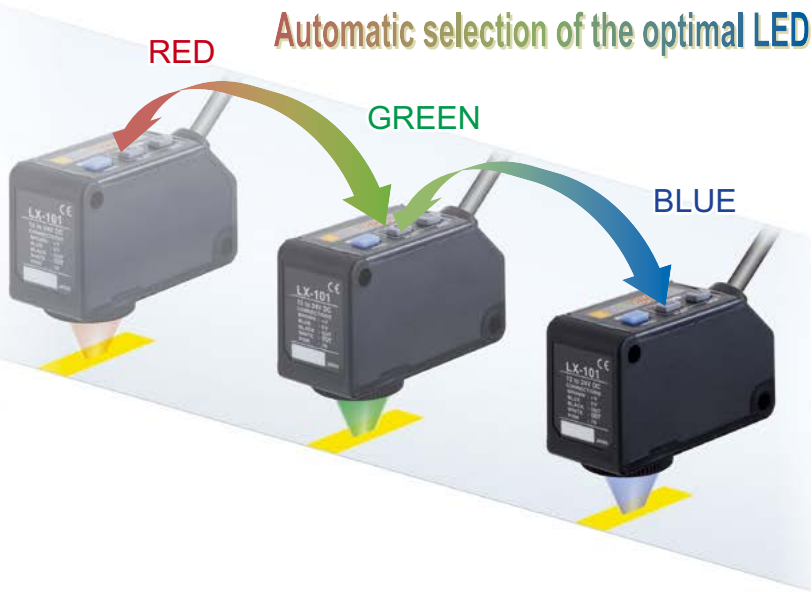

Color mode High precision discrimination

All 3 R•G•B LEDs light up and high precision mark color discrimination occurs using the R•G•B reflective light ratio. This function enables effective detection of films with patterns around the area of the mark.

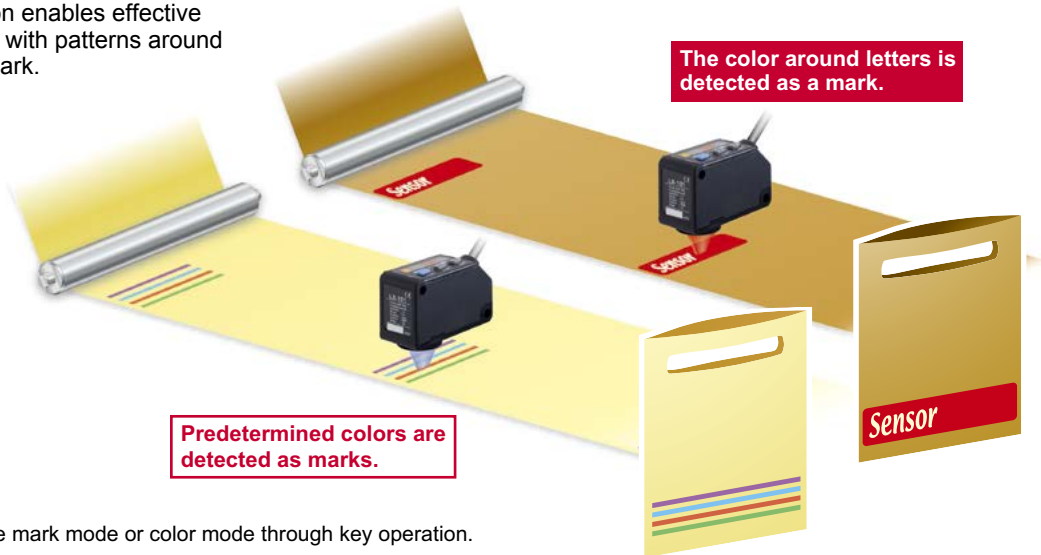

* You can select the mark mode or color mode through key operation.

High precision mark color discrimination

The color mode on the LX-100 series utilizes all 3 R•G•B LEDs to determine the R•G•B ratio of the mark color. The built-in 12-bit A/D converter enables high precision 1/4,000-resolution judgments. The figure below is a graphic description of this process.

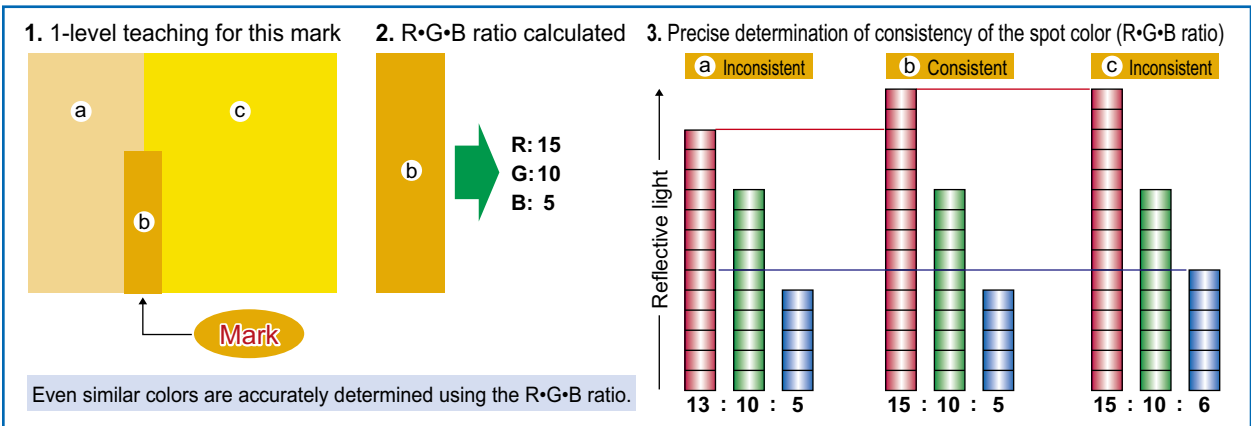

Its digital display makes settings easy! Numerical control of the settings is possible

The 4-digit digital display enables easy verification of received light from marks and base (non-mark area). Also, the threshold value can be controlled numerically enabling setting indication easily. Displaying the direct code enables settings verification. This function is handy for remote maintenance.



Even beginners can quickly master MODE NAVI operation

The sensor's basic operations are represented by 6 indicators (MODE NAVI). The user can check what mode the sensor is presently in with a quick glance making operation simple.

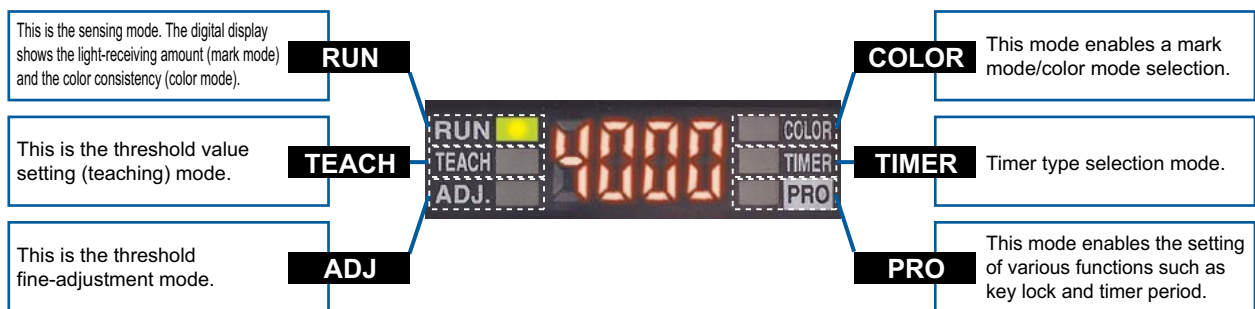

Sensing status digitally controllable

The sensing status, displayed numerically, can be verified at a glance. Also, the sensor settings for each type of packing film can be digitally indicated.

• Example of sensor setting indication



Direct codes enable settings verification at a glance

The settings for the LX-100 series sensors are displayed using a 4-digit direct code. Direct codes enable easy setting verification and maintenance by phone.

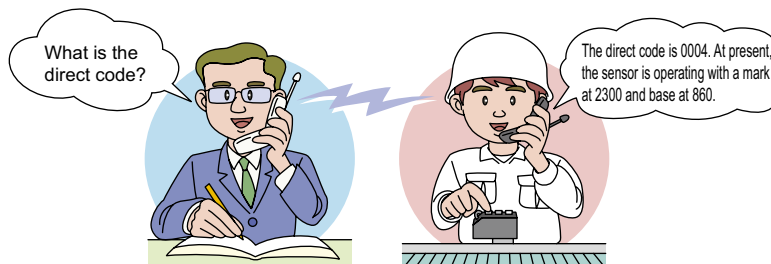

Direct code table (D-Code)

The sensor setting modes can be verified by a 4-digit code (D-Code). The table below shows a list of all available codes.



• When in RUN mode, press the MODE key for at least 2 sec. to display the direct code. (Remove your finger from the MODE key and the direct code will disappear.)

1st digit				2nd digit			3rd digit			4th digit					
Display	Sensing mode (light source color)	Operation mode (Note 1)	Sensing (Note 2)	Display	Display mode	ECO mode (Note 4)	Turn mode (Note 5)	Display	Key lock	Timer mode	Display	Timer period			
0	Mark mode (green)	L-ON	FINE	Standard	OFF	OFF	OFF	Full lock (All operations disabled)	non	non	1	1 ms			
			COARSE								ON	OFF-delay	2	2 ms	
		D-ON	FINE								ON	OFF	ON-delay	5	5 ms
			COARSE								ON	ON	non	10	10 ms
1	Mark mode (blue)	L-ON	FINE	Percent display (Note 3)	OFF	OFF	OFF	RUN teaching (Teaching only enabled)	non	non	20	20 ms			
			COARSE								ON	OFF-delay	50	50 ms	
		D-ON	FINE								ON	OFF	ON-delay	100	100 ms
			COARSE								ON	ON	non	200	200 ms
2	Mark mode (red)	L-ON	FINE	---	---	---	---	---	---	---	500	500 ms			
			COARSE								---	---	---	---	---
		D-ON	FINE								---	---	---	---	---
			COARSE								---	---	---	---	---
3	Color mode	Consistent-ON	FINE	---	---	---	---	---	---	---	---	---			
			COARSE								---	---	---	---	---
		Inconsistent-ON	FINE								---	---	---	---	---
			COARSE								---	---	---	---	---

- Notes: 1) In Mark mode, L-ON/D-ON is automatically set in the sensor. For example, with 2-level teaching, press the ON key at the targeted mark and press the OFF key at the base (non-mark area). When doing so, the operator does not have to consider L-ON/D-ON.
 2) Sensing accuracy can be set to either FINE (standard) or COARSE.
 3) The percent display is only enabled in mark mode.
 4) ECO mode is a function that reduces power consumption by turning off the digital display in the event that no button operations are made for a predetermined time (approx. 10 sec. or more) in RUN mode. Press any button to turn the digital display on again.
 5) The turn mode is a function that reverses the digital display making it easily to be viewed in the event that the sensor installation renders the display up-side-down.
 * Default setting: D-code = "0004".

Super simple teaching

Press the ON button at the targeted mark.

Here is an example of the most basic setting method "2-level teaching".

Mode selection Press MODE key and select TEACH mode.

Teaching

- Align the spot on the mark and press the ON key.
- Align the spot onto the base (non-mark area) and press the OFF key.

* The ① ② order can be reversed.

Sensing Teaching complete. The optimal LED is automatically selected and the sensor automatically returns to RUN mode.

External teaching possible

Teaching is possible through external input using an operation panel or touch panel even on hard-to-reach color mark sensors located inside an equipment. Also, models can be interchanged easily.

- Mark mode**
2-level teaching and full-auto teaching possible
- Color mode**
1-level teaching possible



Other teaching methods

- Full-auto teaching: In Mark mode, teaching is effective without stopping the sensing object.
- 1-level teaching: In Color mode, the color detected is aligned by the spot and teaching is effective.

Compact design for significant space savings

High precision sensing and multiple functions are all packed in a compact W57 × D24 × H38 mm W2.244 × D0.945 × H1.496 in body.

Cable and plug-in connector types are available depending on the equipment used. These sensors can be easily introduced to existing facilities.



Key lock function

The key lock function enables input operation control that prevents mistaken changes in the sensor settings. Other detailed settings include "RUN adjust", allowing threshold value adjustment only, and "RUN teaching", allowing teaching operation only. If the sensor is set to "RUN adjust" or "RUN teaching", adjustment and teaching are possible having the sensor remained in RUN mode.

ORDER GUIDE

Sensors Mating cable is not supplied with the plug-in connector type. Please order it separately.

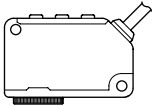
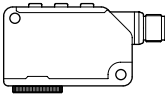
Type	Appearance	Model No.	Output	Sensing range
Cable type		LX-101	NPN open-collector transistor	10 ±3 mm 0.394 ±0.118 in
		LX-101-P	PNP open-collector transistor	
Plug-in connector type		LX-101-Z	NPN open-collector transistor	
		LX-101-P-Z	PNP open-collector transistor	

Mating cables for plug-in connector type sensor Mating cable is not supplied with the plug-in connector type sensor. Please order it separately.

Type	Model No.	Description
Straight	CN-24B-C2	Length: 2 m 6.562 ft
	CN-24B-C5	Length: 5 m 16.404 ft
Elbow	CN-24BL-C2	Length: 2 m 6.562 ft
	CN-24BL-C5	Length: 5 m 16.404 ft

0.34 mm² 4-core cabtyre cable, with connector on one end
Cable outer diameter: ø5 mm ø0.197 in

Mating cables for plug-in connector type sensor

- CN-24B-C2
- CN-24B-C5
- CN-24BL-C2
- CN-24BL-C5

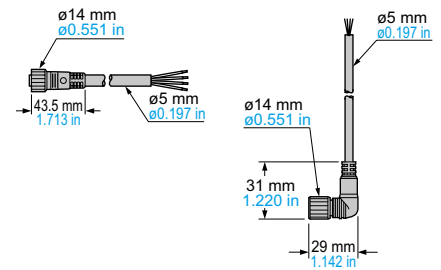

OPTIONS

Type	Model No.	Description
Sensor mounting bracket	MS-LX-1	Mounting bracket made for LX-100 series applicable for various kinds of installations
	MS-LX-2	

Sensor mounting bracket

• MS-LX-1

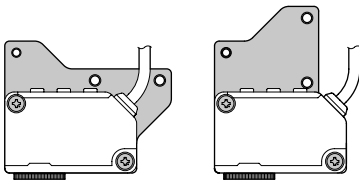

Two M4 (length 28 mm 1.102 in) screws with washers are attached.

• MS-LX-2

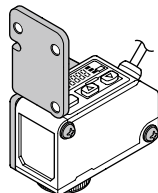

Two M4 (length 30 mm 1.181 in) screws with washers are attached.

SPECIFICATIONS

Item	Model No.	Type	Cable type	Plug-in connector type
		NPN output	LX-101	LX-101-Z
		PNP output	LX-101-P	LX-101-P-Z
CE marking directive compliance		EMC Directive, RoHS Directive		
Sensing range		10 ±3 mm 0.394 ±0.118 in		
Spot size		1 × 5 mm 0.039 × 0.197 in (at 10 mm 0.394 in setting distance)		
Supply voltage		12 to 24 V DC ±10 % Ripple P-P 10 % or less		
Current consumption		Normal mode: 750 mW or less (Current consumption 30 mA or less at 24 V supply voltage) ECO mode: 600 mW or less (Current consumption 25 mA or less at 24 V supply voltage)		
Output 1 (OUT)	<NPN output type> NPN open-collector transistor <ul style="list-style-type: none"> • Maximum sink current: 50 mA • Applied voltage: 30 V DC or less (between output and 0 V) • Residual voltage: 1.5 V or less (at 50 mA sink current) <PNP output type> PNP open-collector transistor <ul style="list-style-type: none"> • Maximum source current: 50 mA • Applied voltage: 30 V DC or less (between output and +V) • Residual voltage: 1.5 V or less (at 50 mA source current) 		<NPN output type> NPN open-collector transistor <ul style="list-style-type: none"> • Maximum sink current: 100 mA • Applied voltage: 30 V DC or less (between output and 0 V) • Residual voltage: 1.5 V or less (at 100 mA sink current) <PNP output type> PNP open-collector transistor <ul style="list-style-type: none"> • Maximum source current: 100 mA • Applied voltage: 30 V DC or less (between output and +V) • Residual voltage: 1.5 V or less (at 100 mA source current) 	
	Short-circuit protection	Incorporated		
Output operation		Mark mode: Light-ON / Dark-ON (Auto-setting on teaching), Color mode: Consistent-ON / Inconsistent-ON (Setting on teaching)		
Output 2 (OUT)	<NPN output type> NPN open-collector transistor <ul style="list-style-type: none"> • Maximum sink current: 50 mA • Applied voltage: 30 V DC or less (between output and 0 V) • Residual voltage: 1.5 V or less (at 50 mA sink current) <PNP output type> PNP open-collector transistor <ul style="list-style-type: none"> • Maximum source current: 50 mA • Applied voltage: 30 V DC or less (between output and +V) • Residual voltage: 1.5 V or less (at 50 mA source current) 		_____	
	Short-circuit protection	Incorporated		
Output operation		Inverted operation of the output 1		
Response time		Mark mode: 45 μs or less, Color mode: 150 μs or less		
Teaching input		<NPN output type> NPN non-contact input <ul style="list-style-type: none"> • Signal condition: High... +5 V to +V, or open Low... 0 to +2 V (source current: 0.5 mA or less) • Input impedance: 10 kΩ approx. 	<PNP output type> PNP non-contact input <ul style="list-style-type: none"> • Signal condition: High... +4 V to +V (sink current: 3 mA or less) Low... 0 to +0.6 V, or open • Input impedance: 10 kΩ approx. 	
Digital display		4-digit red LED display		
Sensitivity setting		Mark mode: 2-level teaching / Full-auto teaching, Color mode: 1-level teaching		
Fine sensitivity adjustment function		Incorporated		
Timer function		Incorporated with variable ON-delay/OFF-delay timer, switchable either effective or ineffective (Timer period: 1 to 500 ms, 9 levels variable)		
Environmental resistance	Protection		IP67 (IEC)	
	Ambient temperature		-10 to +55 °C +14 to +131 °F (No dew condensation or icing allowed), Storage: -20 to +70 °C -4 to +158 °F	
	Ambient humidity		35 to 85 % RH, Storage: 35 to 85 % RH	
	Ambient illuminance		Incandescent light: 3,000 lx or less at the light-receiving face	
	Voltage withstandability		1,000 V AC for one min. between all supply terminals connected together and enclosure	
	Vibration resistance		10 to 500 Hz frequency, 3.0 mm 0.118 in double amplitude (max. 20 G) in X, Y and Z directions for two hours each	
	Shock resistance		500 m/s ² acceleration (50 G approx.) in X, Y and Z directions three times each	
Emitting element		Combined Red / Green / Blue LEDs (Peak emission wavelength: 640 nm 0.025 mil / 525 nm 0.021 mil / 470 nm 0.019 mil)		
Material		Enclosure: PBT, Display cover: Polycarbonate, Operation buttons: Silicone rubber, Lens: Glass, Lens holder: Aluminum		
Cable		0.2 mm ² 5-core cabtyre cable, 2 m 6.562 ft long	(Note 2)	
Cable extension		Extension up to total 100 m 328.084 ft is possible with 0.3 mm ² , or more, cable.		
Weight		Net weight: 120 g approx., Gross weight: 180 g approx.	Net weight: 55 g approx., Gross weight: 120 g approx.	
Accessory		M4 (length 30 mm 1.181 in) screw with washers: 2 pcs.		

Notes: 1) Where measurement conditions have not been specified precisely, the conditions used were an ambient temperature of +23 °C **+73.4 °F**.

2) Mating cable is not supplied with the plug-in connector type. Please order it separately.

PRECAUTIONS FOR PROPER USE



- Never use this product as a sensing device for personnel protection.
- In case of using sensing devices for personnel protection, use products which meet laws and standards, such as OSHA, ANSI or IEC etc., for personnel protection applicable in each region or country.

Mounting

- Care must be taken regarding the sensor mounting direction with respect to the object's direction of movement.

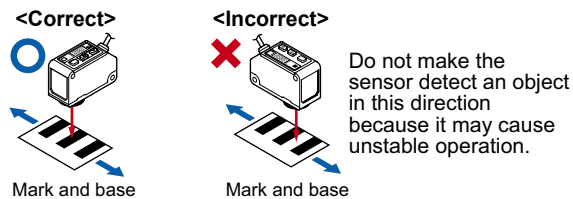

- With the optional sensor mounting bracket, the tightening torque should be 0.8 N·m or less.

Sensing glossy object

- Objects with a glossy surface have a large amount of specular reflection particles that may destabilize sensing. In such a case, by slightly tilting the sensor's beam axis, this specular reflection can be reduced rendering sensing more stable.
- If the surface of the sensing object has a shine, mount the sensor inclining approx. 10 to 15 degrees against the sensing object.

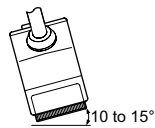

Wiring

- Make sure to carry out wiring in the power supply off condition.
- Take care that wrong wiring will damage the sensor.
- Verify that the supply voltage variation is within the rating.
- Take care that if a voltage exceeding the rated range is applied, or if an AC power supply is directly connected, the sensor may get burnt or damaged.
- In case noise generating equipment (switching regulator, inverter motor, etc.) is used in the vicinity of this product, connect the frame ground (F.G.) terminal of the equipment to an actual ground.
- If power is supplied from a commercial switching regulator, ensure that the frame ground (F.G.) terminal of the power supply is connected to an actual ground.
- Take care that short-circuit of the load or wrong wiring may burn or damage the sensor.
- Do not run the wires together with high-voltage lines or power lines or put them in the same raceway. This can cause malfunction due to induction.
- Extension up to total 100 m is possible with 0.3 mm², or more, cable. However, in order to reduce noise, make the wiring as short as possible.

Others

- Do not use during the initial transient time (0.5 sec.) after the power supply is switched on.
- Take care that the sensor is not directly exposed to fluorescent light from a rapid-starter lamp or a high frequency light device or sunlight etc., as it may affect the sensing performance.
- Do not touch the lens of the sensor by hand directly. If the lens becomes dirty, wipe it off with a soft cloth gently.
- When the inside lens is steamed up, unscrew the lens to get rid of the condensation.
- These sensors are only for indoor use.
- Do not use this sensor in places having excessive vapor, dust, etc., or where it may come in direct contact with water, or corrosive gas.
- Take care that the product does not come in contact with water, oil, grease, or organic solvents, such as, thinner, etc.
- Make sure that stress by forcible bend or pulling with 76 N, or more, force is not applied to the sensor cable joint.
- This sensor cannot be used in an environment containing inflammable or explosive gases.
- Never disassemble or modify the sensor.

LIST OF PROMODE SETTING ITEMS

• Before performing teaching or each detail setting, perform the setting of either mark mode or color mode with mark/color mode setting of NAVI mode.

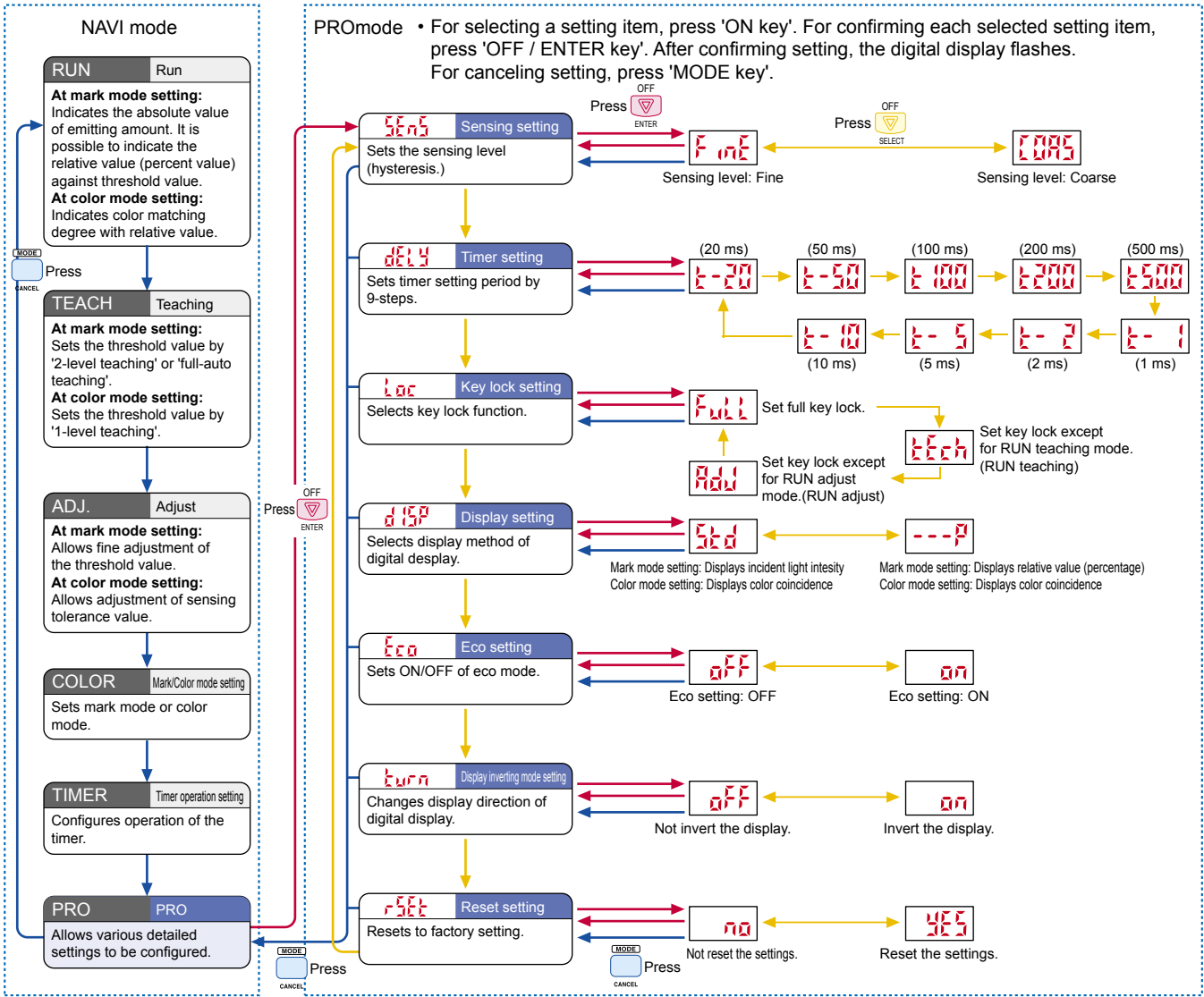

DIMENSIONS (Unit: mm in)

The CAD data can be downloaded from our website.

LX-101 LX-101-P Sensor

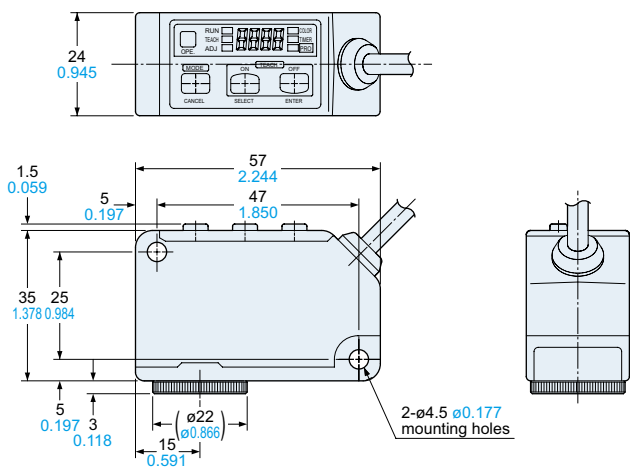

LX-101-Z LX-101-P-Z Sensor

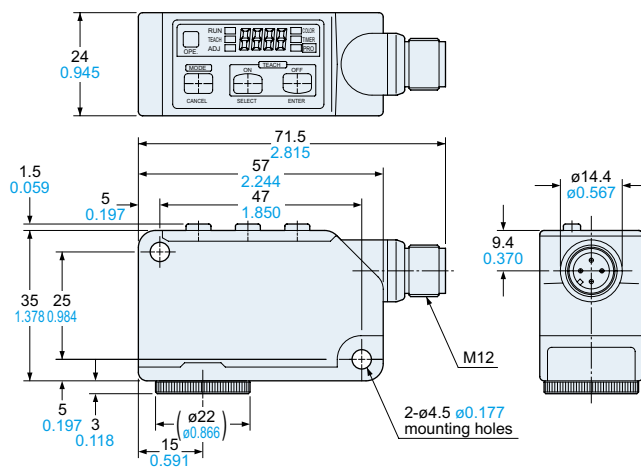

MS-LX-1 Sensor mounting bracket (Optional)

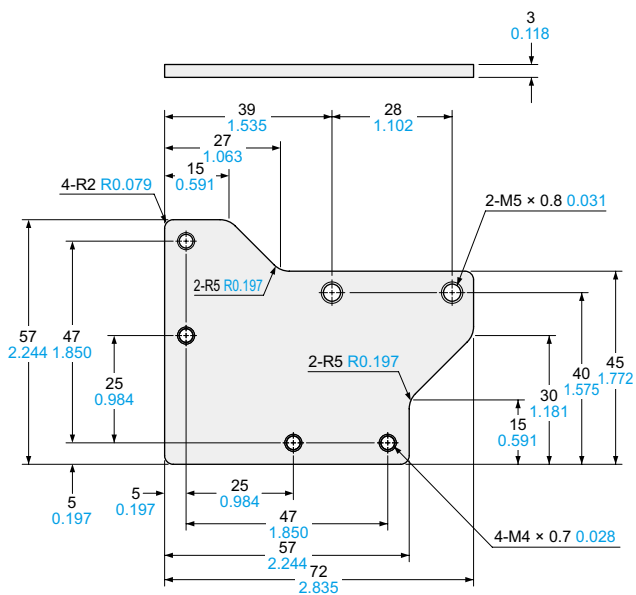

Material: Stainless steel (SUS)
Two M4 (length 28 mm 1.102 in) screws with washers are attached.

MS-LX-2 Sensor mounting bracket (Optional)

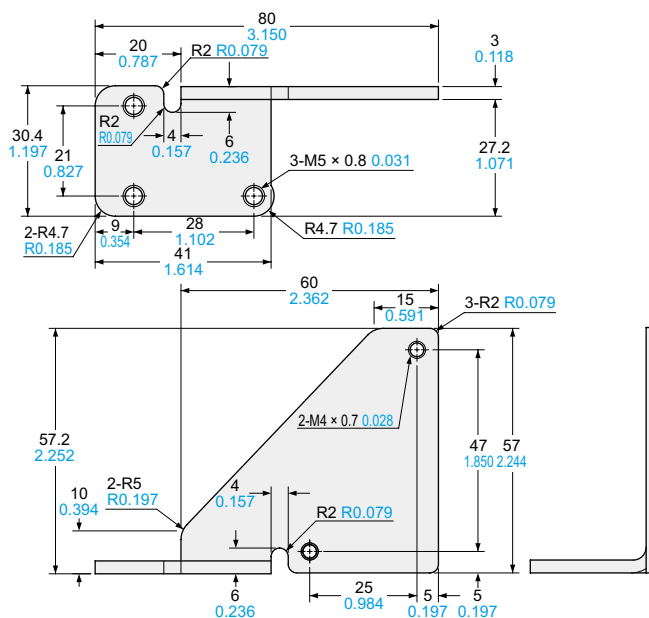

Material: Stainless steel (SUS)
Two M4 (length 30 mm 1.181 in) screws with washers are attached.

Disclaimer

The applications described in the catalog are all intended for examples only. The purchase of our products described in the catalog shall not be regarded as granting of a license to use our products in the described applications. We do NOT warrant that we have obtained some intellectual properties, such as patent rights, with respect to such applications, or that the described applications may not infringe any intellectual property rights, such as patent rights, of a third party.

Panasonic
INDUSTRY

Panasonic Industry Co., Ltd.

Industrial Device Business Division

7-1-1, Morofuku, Daito-shi, Osaka 574-0044, Japan

industrial.panasonic.com/ac/e/