

N-channel 600 V, 0.230 Ω typ., 13 A, MDmesh™ M2 EP Power MOSFET in a TO-220FP package

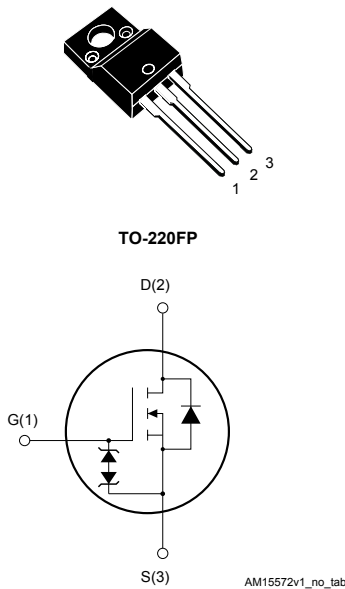

Features

Order code	V_{DS}	$R_{DS(on)}$ max	I_D
STF20N60M2-EP	600 V	0.278 Ω	13 A

- Extremely low gate charge
- Excellent output capacitance (C_{OSS}) profile
- Very low turn-off switching losses
- 100% avalanche tested
- Zener-protected

Applications

- Switching applications
- Tailored for very high frequency converters ($f > 150$ kHz)

Description

This device is an N-channel Power MOSFET developed using MDmesh™ M2 enhanced performance (EP) technology. Thanks to its strip layout and an improved vertical structure, the device exhibits low on-resistance, optimized switching characteristics with very low turn-off switching losses, rendering it suitable for the most demanding very high frequency converters.

Product status

STF20N60M2-EP

Product summary

Order code	STF20N60M2-EP
Marking	20N60M2EP
Package	TO-220FP
Packing	Tube

1 Electrical ratings

Table 1. Absolute maximum ratings

Symbol	Parameter	Value	Unit
V_{GS}	Gate-source voltage	± 25	V
V_{GS}	Transient gate-source voltage ($t_p \leq 10$ ns)	± 35	V
$I_D^{(1)}$	Drain current (continuous) at $T_C = 25$ °C	13	A
$I_D^{(1)}$	Drain current (continuous) at $T_C = 100$ °C	8	A
$I_{DM}^{(2)}$	Drain current (pulsed)	52	A
P_{TOT}	Total dissipation at $T_C = 25$ °C	25	W
$dv/dt^{(3)}$	Peak diode recovery voltage slope	15	V/ns
$dv/dt^{(4)}$	MOSFET dv/dt ruggedness	50	V/ns
V_{ISO}	Insulation withstand voltage (RMS) from all three leads to external heat sink ($t = 1$ s, $T_C = 25$ °C)	2.5	kV
T_{stg}	Storage temperature range	-55 to 150	°C
T_j	Operating junction temperature range		

1. Limited by maximum junction temperature
2. Pulse width limited by safe operating area.
3. $I_{SD} \leq 13$ A, $di/dt \leq 400$ A/ μ s, $V_{DS(peak)} < V_{(BR)DSS}$, $V_{DD} = 400$ V
4. $V_{DS} \leq 480$ V

Table 2. Thermal data

Symbol	Parameter	Value	Unit
$R_{thj-case}$	Thermal resistance junction-case	5	°C/W
$R_{thj-amb}$	Thermal resistance junction-ambient	62.5	°C/W

Table 3. Avalanche characteristics

Symbol	Parameter	Value	Unit
I_{AR}	Avalanche current, repetitive or not repetitive (pulse width limited by T_{jmax})	2.7	A
E_{AS}	Single pulse avalanche energy (starting $T_j = 25$ °C, $I_D = I_{AR}$, $V_{DD} = 50$ V)	138	mJ

2 Electrical characteristics

$T_C = 25\text{ °C}$ unless otherwise specified

Table 4. On/off states

Symbol	Parameter	Test conditions	Min.	Typ.	Max.	Unit
$V_{(BR)DSS}$	Drain-source breakdown voltage	$V_{GS} = 0\text{ V}$, $I_D = 1\text{ mA}$	600			V
I_{DSS}	Zero gate voltage	$V_{GS} = 0\text{ V}$, $V_{DS} = 600\text{ V}$			1	μA
	Drain current	$V_{GS} = 0\text{ V}$, $V_{DS} = 600\text{ V}$, $T_C = 125\text{ °C}^{(1)}$			100	μA
I_{GSS}	Gate-body leakage current	$V_{DS} = 0\text{ V}$, $V_{GS} = \pm 25\text{ V}$			± 10	μA
$V_{GS(th)}$	Gate threshold voltage	$V_{DS} = V_{GS}$, $I_D = 250\text{ }\mu\text{A}$	3.25	4	4.75	V
$R_{DS(on)}$	Static drain-source on-resistance	$V_{GS} = 10\text{ V}$, $I_D = 6.5\text{ A}$		0.230	0.278	Ω

1. Defined by design, not subject to production test.

Table 5. Dynamic

Symbol	Parameter	Test conditions	Min.	Typ.	Max.	Unit
C_{iss}	Input capacitance	$V_{DS} = 100\text{ V}$, $f = 1\text{ MHz}$, $V_{GS} = 0\text{ V}$	-	787	-	μF
C_{oss}	Output capacitance		-	50	-	
C_{riss}	Reverse transfer capacitance		-	1.2	-	
$C_{oss\text{ eq.}}^{(1)}$	Equivalent output capacitance	$V_{DS} = 0\text{ to }480\text{ V}$, $V_{GS} = 0\text{ V}$	-	89	-	μF
R_G	Intrinsic gate resistance	$f = 1\text{ MHz}$, $I_D = 0\text{ A}$	-	5.9	-	Ω
Q_g	Total gate charge	$V_{DD} = 480\text{ V}$, $I_D = 13\text{ A}$, $V_{GS} = 0\text{ to }10\text{ V}$ (see Figure 15. Test circuit for gate charge behavior)	-	22	-	nC
Q_{gs}	Gate-source charge		-	3.5	-	
Q_{gd}	Gate-drain charge		-	10.5	-	

1. $C_{oss\text{ eq.}}$ is defined as a constant equivalent capacitance giving the same charging time as C_{oss} when V_{DS} increases from 0 to 80% V_{DSS}

Table 6. Switching energy

Symbol	Parameter	Test conditions	Min.	Typ.	Max.	Unit
E_{off}	Turn-off energy (from 90% V_{GS} to 0% I_D)	$V_{DD} = 400\text{ V}$, $I_D = 2\text{ A}$, $R_G = 4.7\text{ }\Omega$, $V_{GS} = 10\text{ V}$	-	7.2	-	μJ
		$V_{DD} = 400\text{ V}$, $I_D = 5\text{ A}$, $R_G = 4.7\text{ }\Omega$, $V_{GS} = 10\text{ V}$	-	20.4	-	μJ

Table 7. Switching times

Symbol	Parameter	Test conditions	Min.	Typ.	Max.	Unit
$t_{d(on)}$	Turn-on delay time	$V_{DD} = 300\text{ V}$, $I_D = 6.5\text{ A}$, $R_G = 4.7\ \Omega$, $V_{GS} = 10\text{ V}$ (see Figure 14. Test circuit for resistive load switching times and Figure 19. Switching time waveform)	-	10.5	-	ns
t_r	Rise time		-	5.2	-	ns
$t_{d(off)}$	Turn-off delay time		-	41	-	ns
t_f	Fall time		-	8	-	ns

Table 8. Source-drain diode

Symbol	Parameter	Test conditions	Min.	Typ.	Max.	Unit
I_{SD}	Source-drain current		-		13	A
$I_{SDM}^{(1)}$	Source-drain current (pulsed)		-		52	A
$V_{SD}^{(2)}$	Forward on voltage	$V_{GS} = 0\text{ V}$, $I_{SD} = 13\text{ A}$	-		1.6	V
t_{rr}	Reverse recovery time	$I_{SD} = 13\text{ A}$, $di/dt = 100\text{ A}/\mu\text{s}$, $V_{DD} = 60\text{ V}$ (see Figure 16. Test circuit for inductive load switching and diode recovery times)	-	230		ns
Q_{rr}	Reverse recovery charge		-	2.3		μC
I_{RRM}	Reverse recovery current		-	20		A
t_{rr}	Reverse recovery time	$I_{SD} = 13\text{ A}$, $di/dt = 100\text{ A}/\mu\text{s}$, $V_{DD} = 60\text{ V}$, $T_j = 150\text{ }^\circ\text{C}$ (see Figure 16. Test circuit for inductive load switching and diode recovery times)	-	287		ns
Q_{rr}	Reverse recovery charge		-	2.9		μC
I_{RRM}	Reverse recovery current		-	20.2		A

1. Pulse width is limited by safe operating area
2. Pulsed: pulse duration = 300 μs , duty cycle 1.5%

2.1 Electrical characteristics (curves)

Figure 1. Safe operating area

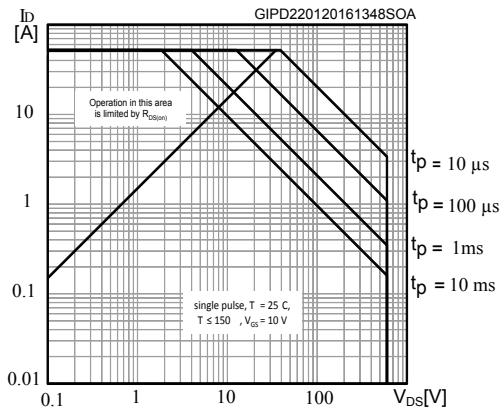

Figure 2. Thermal impedance

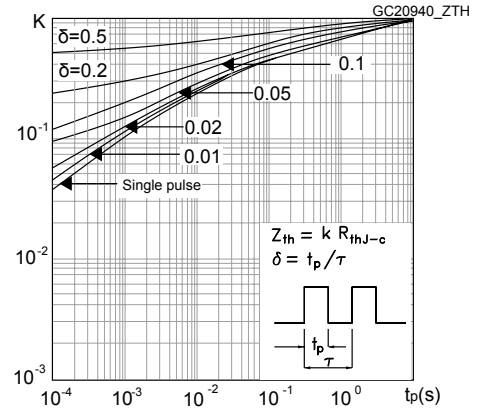

Figure 3. Output characteristics

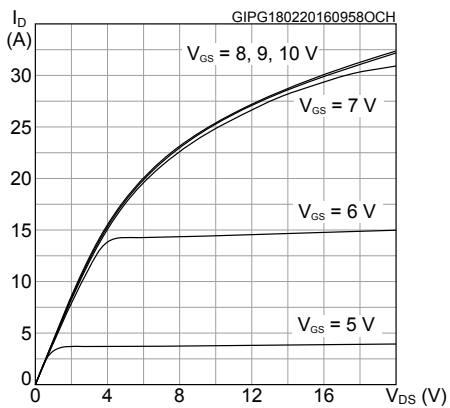

Figure 4. Transfer characteristics

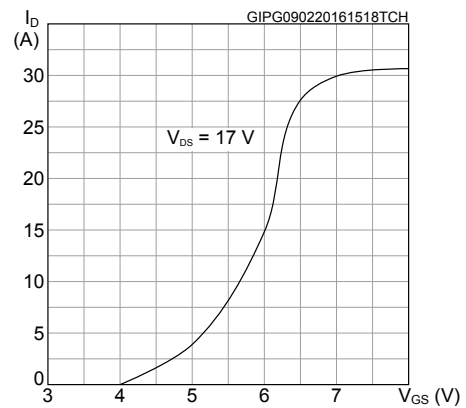

Figure 5. Gate charge vs gate-source voltage

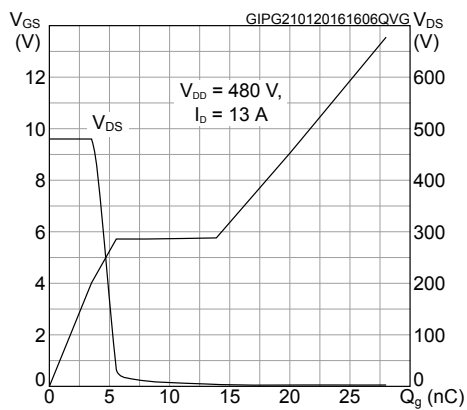

Figure 6. Static drain-source on-resistance

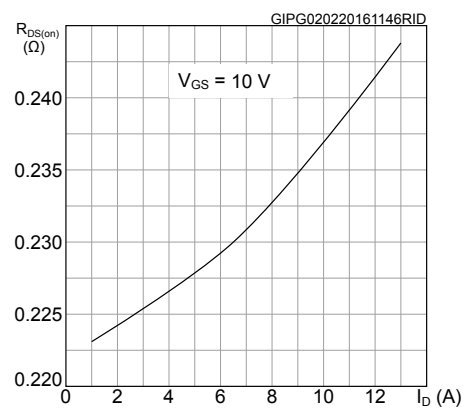

Figure 7. Capacitance variations

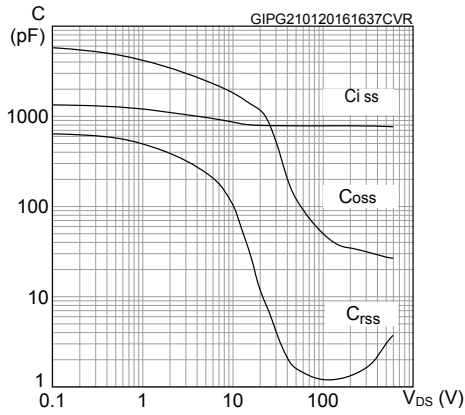

Figure 8. Output capacitance stored energy

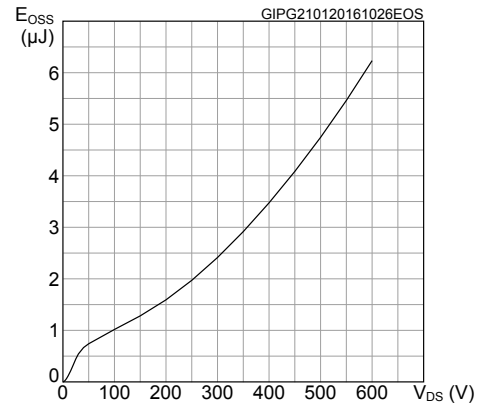

Figure 9. Normalized V_{(BR)DSS} vs temperature

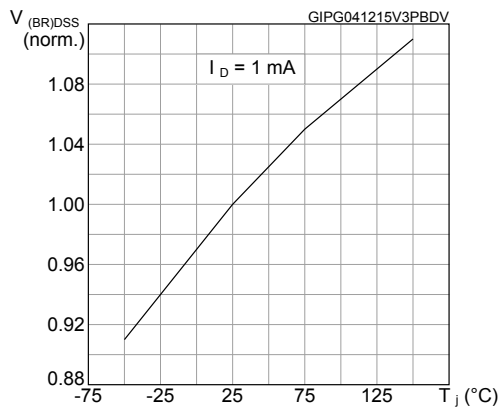

Figure 10. Normalized gate threshold voltage vs temperature

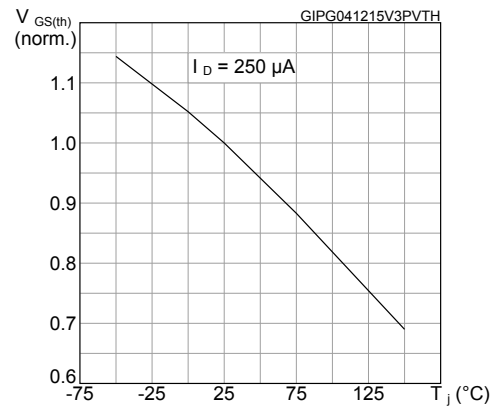

Figure 11. Normalized on-resistance vs temperature

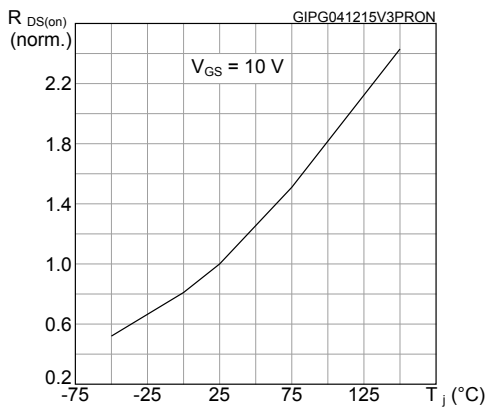

Figure 12. Source-drain diode forward characteristics

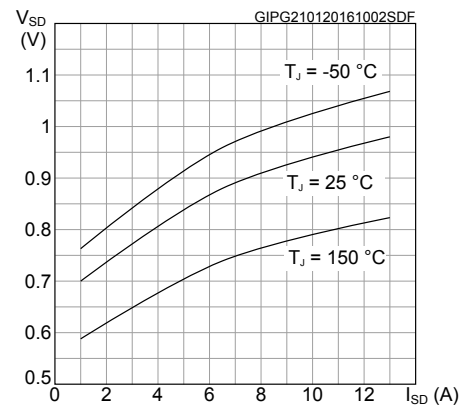
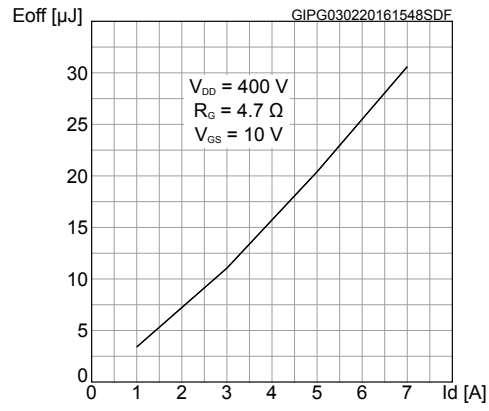

Figure 13. Turn-off switching energy vs drain current



4 Package information

In order to meet environmental requirements, ST offers these devices in different grades of ECOPACK® packages, depending on their level of environmental compliance. ECOPACK® specifications, grade definitions and product status are available at: www.st.com. ECOPACK® is an ST trademark.

4.1 TO-220FP package information

Figure 20. TO-220FP package outline

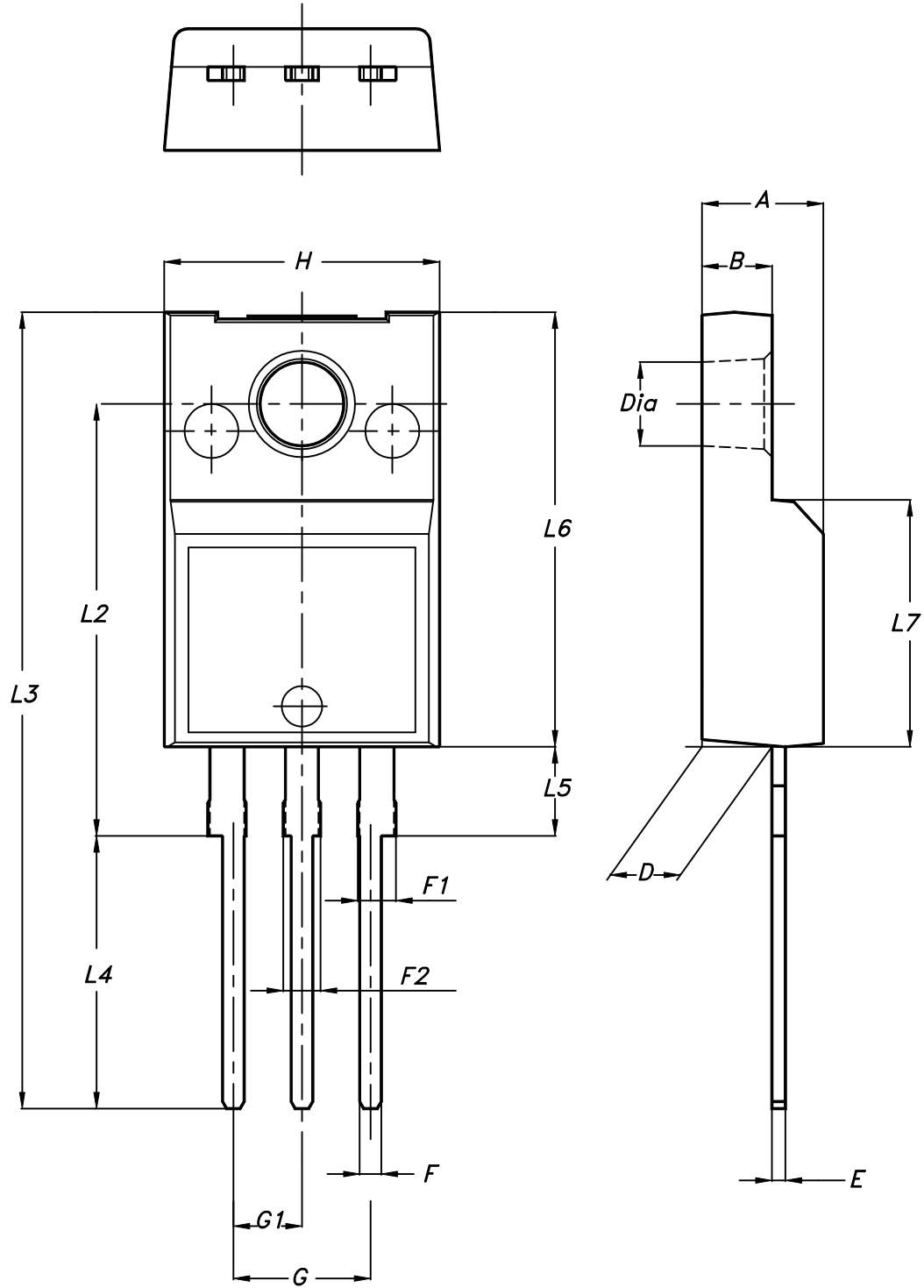

7012510_Rev_12_B

Table 9. TO-220FP package mechanical data

Dim.	mm		
	Min.	Typ.	Max.
A	4.4		4.6
B	2.5		2.7
D	2.5		2.75
E	0.45		0.7
F	0.75		1
F1	1.15		1.70
F2	1.15		1.70
G	4.95		5.2
G1	2.4		2.7
H	10		10.4
L2		16	
L3	28.6		30.6
L4	9.8		10.6
L5	2.9		3.6
L6	15.9		16.4
L7	9		9.3
Dia	3		3.2

Revision history

Table 10. Document revision history

Date	Revision	Changes
29-Feb-2016	1	First release.
18-Aug-2016	2	Modified: <i>Table 2: "Absolute maximum ratings"</i> Minor text changes
02-Mar-2018	3	Removed maturity status indication from cover page. The document status is production data. Updated <i>Table 1. Absolute maximum ratings, Table 4. On/off states and Table 5. Dynamic.</i> Updated <i>Figure 1. Safe operating area, Figure 3. Output characteristics, Figure 4. Transfer characteristics and Figure 5. Gate charge vs gate-source voltage.</i> Minor text changes.
04-Jun-2018	4	Modified Table 1. Absolute maximum ratings. Modified Figure 1. Safe operating area . Modified Table 8. Source-drain diode. Minor text changes.

Contents

1	Electrical ratings	2
2	Electrical characteristics	3
2.1	Electrical characteristics (curves)	5
3	Test circuits	8
4	Package information	9
4.1	TO-220FP package information	9
	Revision history	12

IMPORTANT NOTICE – PLEASE READ CAREFULLY

STMicroelectronics NV and its subsidiaries (“ST”) reserve the right to make changes, corrections, enhancements, modifications, and improvements to ST products and/or to this document at any time without notice. Purchasers should obtain the latest relevant information on ST products before placing orders. ST products are sold pursuant to ST’s terms and conditions of sale in place at the time of order acknowledgement.

Purchasers are solely responsible for the choice, selection, and use of ST products and ST assumes no liability for application assistance or the design of Purchasers’ products.

No license, express or implied, to any intellectual property right is granted by ST herein.

Resale of ST products with provisions different from the information set forth herein shall void any warranty granted by ST for such product.

ST and the ST logo are trademarks of ST. All other product or service names are the property of their respective owners.

Information in this document supersedes and replaces information previously supplied in any prior versions of this document.

© 2018 STMicroelectronics – All rights reserved